

TOLLING REGULATIONS FOR THE MOTORWAYS AND EXPRESSWAYS OF AUSTRIA

**Formally approved in accordance with section 14(2) Federal Road Tolls Act 2002 and,
with regard to Tolling Regulations Part A II, adopted by decree by the Federal Minister
of Transport, Innovation and Technology in agreement with the Federal Minister of
Finance**

**GZ: 325.009/1-I/K2-2003
last amendment
GZ: 323.540/0083-I/K2/2017**

Valid from 01.12.2017

Version 49

TABLE OF CONTENTS

| | |
|---|----|
| PREAMBLE..... | 8 |
| PART A I: TOLLING REGULATIONS FOR VEHICLES WITH A MAXIMUM GROSS VEHICLE WEIGHT OF UP TO 3.5 t..... | 10 |
| 1. General regulations..... | 10 |
| 1.1 DEFINITION OF TERMS..... | 10 |
| 1.2 SCOPE OF APPLICATION | 10 |
| 1.3 MANDATORY VIGNETTE..... | 11 |
| 1.3.1 Network of roads on which tolls are levied | 11 |
| 1.3.2 Signing..... | 12 |
| 1.3.3 Exemptions from the mandatory vignette | 12 |
| 1.3.3.1 Permanent exemptions..... | 12 |
| 1.3.3.2 Temporary exemptions..... | 14 |
| 1.3.3.2.1 <i>Urgent traffic restrictions</i> | 14 |
| 1.3.3.2.2 <i>Exceptions for vehicles delivering humanitarian aid</i> | 14 |
| 1.4 VIGNETTE PRICES | 14 |
| 1.5 DURATION OF ENTITLEMENT OF USE | 14 |
| 1.5.1 Annual vignette | 14 |
| 1.5.2 Two-month vignette | 15 |
| 1.5.3 Ten-day vignette | 15 |
| 1.6 RELIEF MEASURES FOR DISABLED DRIVERS..... | 16 |
| 1.6.1 Replacement of the vignette | 16 |
| 1.6.2 Non-provision of a free annual vignette in time | 17 |
| 1.7 OBLIGATIONS | 17 |
| 1.8 MONITORING OF THE MANDATORY VIGNETTE..... | 18 |
| 1.8.1 Inspection by road inspection authorities and toll enforcement officers | 18 |
| 1.8.2 Automatic monitoring of vignettes | 20 |
| 1.9 TOLL EVASION..... | 20 |
| 1.9.1 Penalties for toll evasion..... | 21 |
| 1.9.2 Non-imposition of a penalty | 21 |
| 1.9.3 Substitute toll | 21 |
| 1.9.3.1 <i>Method of payment</i> | 21 |
| 1.9.3.1.1 <i>Apprehension by toll enforcement officers</i> | 21 |
| 1.9.3.1.2 <i>Discovery of a violation in the absence of the driver</i> | 21 |
| 1.9.3.1.3 <i>Retroactive summons procedure</i> | 22 |
| 1.9.3.2 <i>Substitute toll rate</i> | 22 |
| 1.9.3.3 <i>Continuing the journey with a substitute toll receipt or payment slip</i> | 22 |
| 1.9.3.4 <i>Payment of the substitute toll</i> | 23 |
| 1.10 VIOLATION OF THE OBLIGATION TO STOP | 23 |
| 1.11 DATA PROTECTION AND DATA SECURITY | 23 |
| 1.12 PLACE OF AND APPLICABLE LAW | 23 |
| 1.13 COMPETENCE AND CUSTOMER SERVICE | 24 |
| 2 FURTHER REGULATIONS WHEN USING A TOLL STICKER..... | 24 |
| 2.1 TOLL STICKER SALES OUTLETS..... | 24 |
| 2.2 ATTACHING THE TOLL STICKER..... | 24 |
| 2.2.1 Where and how to attach the toll sticker..... | 24 |
| 2.2.2 Permissibility of carrying an unattached toll sticker in the vehicle | 25 |
| 2.3 TOLL STICKER REPLACEMENT | 25 |
| 3 FURTHER REGULATIONS WHEN USING A DIGITAL VIGNETTE | 26 |
| 3.1 AVAILABILITY OF THE DIGITAL VIGNETTE | 26 |
| 3.2 OBTAINING THE DIGITAL VIGNETTE | 26 |
| 3.2.1 Obtaining the digital vignette in the webshop and with the ASFINAG app..... | 26 |
| 3.2.2 Purchase of the digital vignette at a vending machine | 27 |
| 3.2.3 Means of payment..... | 28 |

| | | |
|--|--|-----------|
| 3.2.4 | Additional services | 28 |
| 3.2.5 | Terms of use | 29 |
| 3.3 | RIGHT OF WITHDRAWAL | 29 |
| 3.4 | SPECIFICS FOR ENTREPRENEURS CONCERNING THE PURCHASE OF A DIGITAL VIGNETTE..... | 29 |
| 3.5 | POSSIBLE CHANGES BEFORE THE BEGINNING OF VALIDITY..... | 29 |
| 3.6 | POSSIBLE CHANGES AFTER THE BEGINNING OF VALIDITY..... | 31 |
| 3.6.1 | Conditional changes in the ASFINAG webshop..... | 32 |
| 3.6.2 | Changes at the ASFINAG service center..... | 32 |
| PART A II: TOLLING REGULATIONS FOR VEHICLES WITH A MAXIMUM GROSS VEHICLE WEIGHT OF UP TO 3.5 t FOR EXISTING TOLL ROAD SECTIONS ON THE AUSTRIAN MOTORWAY AND EXPRESSWAY NETWORK: A 9, A 10, A 11, A 13, S 16 | | |
| | | 34 |
| 1. | GENERAL REGULATIONS | 34 |
| 1.1. | DEFINITION OF TERMS | 34 |
| 1.2. | SCOPE OF APPLICATION..... | 34 |
| 1.3. | ROAD SECTIONS ON WHICH TOLLS ARE LEVIED..... | 34 |
| 1.3.1. | Names of the section toll segments and toll points | 34 |
| 1.3.2. | Signing..... | 35 |
| 1.4. | Place of jurisdiction and applicable law | 36 |
| 1.5. | COMPETENCE AND CUSTOMER SERVICE..... | 36 |
| 2. | Obligation to pay the section toll | 36 |
| 2.1. | Mixed toll lane operation | 36 |
| 2.2. | Open toll lane operation..... | 36 |
| 2.3. | Exemptions from the mandatory toll..... | 37 |
| 2.3.1. | Permanent exemptions | 37 |
| 2.3.2. | Temporary exemptions | 38 |
| 3. | TOLL RATES..... | 38 |
| 3.1 | Standard toll rates..... | 38 |
| 3.1.1 | A 9 Gleinalm and A 9 Bosruck | 38 |
| 3.1.2 | A 10 Tauern/Katschberg | 39 |
| 3.1.3 | A 11 Karawanken | 39 |
| 3.1.4 | A 13 Brenner | 39 |
| 3.1.5 | S 16 Arlberg road tunnel | 39 |
| 3.2 | TYPE OF RATES | 40 |
| 3.2.1 | Single trip | 40 |
| 3.2.2 | Annual card (without vignette credit) | 40 |
| 3.2.3 | Annual card with vignette credit | 40 |
| 3.2.4 | Annual card for commuters..... | 40 |
| 3.2.5 | Annual card for disabled drivers..... | 40 |
| 3.2.6 | Annual card for disabled drivers on the A 13 | 41 |
| 3.2.7 | Monthly card for the A 13 | 41 |
| 3.2.8 | Resident's card for the A 13..... | 41 |
| 3.2.9 | 14-trip monthly card for the A 11 | 42 |
| 3.3 | LOSS OF LICENSE PLATE NUMBER RELATED CARDS | 42 |
| 4. | PAYMENT METHODS..... | 42 |
| 4.1. | PAYMENT AT THE TOLL POINT | 42 |
| 4.2. | PURCHASE IN ADVANCE | 42 |
| 4.2.1. | Purchase in the webshop and with the ASFINAG app | 42 |
| 4.2.2. | Purchase at the vending machine..... | 42 |

| | | |
|--|---|----|
| 4.2.3. | Purchase at sales points | 43 |
| 4.2.4. | Means of payment | 43 |
| 4.3. | ADDITIONAL SERVICES (“my account”)..... | 43 |
| 4.4. | TERMS OF USE | 43 |
| 4.5. | RIGHT OF WITHDRAWAL | 43 |
| 4.6. | SPECIFICS FOR ENTREPRENEURS..... | 44 |
| 4.7. | POSSIBLE CHANGES..... | 44 |
| 4.8. | CHANGES AFTER THE BEGINNING OF VALIDITY | 45 |
| 5. | DATA PROTECTION AND DATA SECURITY | 46 |
| 6. | monitoring the properly paid SECTION TOLL..... | 46 |
| 6.1. | TOLL ENFORCEMENT OFFICERS | 46 |
| 6.2. | Confiscation OF LICENSE PLATE NUMBER RELATED CARDS | 48 |
| 7. | TOLL EVASION..... | 48 |
| 7.1. | PENALTIES FOR TOLL EVASION | 48 |
| 7.2. | NON-IMPOSITION OF A PENALTY | 48 |
| 7.3. | SUBSTITUTE TOLL | 48 |
| 7.3.1. | Method of payment | 48 |
| 7.3.1.1. | <i>Apprehension by toll enforcement officers</i> | 48 |
| 7.3.1.2. | <i>Retroactive summons procedure</i> | 48 |
| 7.3.2. | Substitute toll rate | 49 |
| 7.3.3. | Continuing the journey with a substitute toll receipt..... | 49 |
| 7.3.4. | Payment of the substitute toll..... | 49 |
| 8. | VIOLATION OF THE OBLIGATION TO STOP | 49 |
| PART B: TOLLING REGULATIONS FOR TWIN-TRACK VEHICLES WITH A MAXIMUM GROSS VEHICLE WEIGHT OF MORE THAN 3.5 T | | 50 |
| 1 | GENERAL INFORMATION..... | 50 |
| 2 | SCOPE OF APPLICATION..... | 50 |
| 3 | THE MANDATORY TOLL | 51 |
| 3.1 | Network of roads on which tolls are levied | 51 |
| 3.1.1 | Areas with existing section toll | 52 |
| 3.1.2 | The mandatory toll in areas around road works | 53 |
| 3.1.3 | Temporary entries and exits in accordance with section 26(2) Federal Highways Act | 53 |
| 3.2 | Signing..... | 53 |
| 3.3 | Exemptions from the mandatory toll | 54 |
| 3.3.1 | Permanent exemptions | 54 |
| 3.3.2 | Temporary exemptions | 55 |
| 3.3.3 | Special exemptions | 55 |
| 4 | TOLL RATES..... | 56 |
| 5 | REGISTERING WITH AND DEREGISTERING FROM THE TOLL SYSTEM | 58 |
| 5.1 | General information | 58 |
| 5.2 | Declaration of the relevant EURO emission class..... | 59 |
| 5.3 | Distribution channels | 67 |
| 5.4 | Processing fee | 67 |
| 5.5 | Payment procedures..... | 68 |
| 5.5.1. | General information | 68 |
| 5.5.2. | About the post-pay procedure | 68 |
| 5.5.3. | About the pre-pay procedure | 68 |
| 5.6 | Data storage | 68 |
| 5.6.1. | General information | 68 |

| | | |
|---------|--|-----------|
| 5.6.2. | Obligation to inform ASFINAG immediately of changes in the data to be stored in accordance with section 5.6.1 | 69 |
| 5.6.3. | SALE of a vehicle | 70 |
| 5.6.4. | Vehicle RENTAL | 71 |
| 5.6.5. | Transferable license plates (Wechselkennzeichen)..... | 72 |
| 5.6.6. | Test drivers and motor trader trips | 73 |
| 5.7 | Provisions relating to the GO-Box | 76 |
| 5.7.1. | General information..... | 76 |
| 5.7.2. | GO-Box: period of validity, guarantee, exchange, bearing of costs, and recall | 77 |
| 5.7.2.6 | <i>Legal consequences of deactivation or the use of the toll road network after the expiry of the period of validity</i> | <i>78</i> |
| 5.7.3. | Theft, loss, and deactivation of the GO-Box | 78 |
| 5.7.4. | Deregistration, returning the GO-Box, and the lapse of toll credit..... | 78 |
| 5.7.5. | Transportation of GO-Boxes without the obligation to pay the mandatory toll | 80 |
| 6 | ITEMIZED TOLL INFORMATION SHEETS AND COLLECTIVE INVOICE STATEMENTS | 80 |
| 6.1 | Itemized toll information sheets | 80 |
| 6.2 | Collective invoice statements | 80 |
| 7 | RETROACTIVE TOLL PAYMENT | 81 |
| 7.1 | Retroactive payment at GO points of sale and to toll enforcement officers | 81 |
| 7.2 | Central retroactive payment in the event of use of a too low category or toll rate group | 82 |
| 7.3 | Retroactive billing | 83 |
| 8 | THE DRIVER'S OBLIGATIONS..... | 83 |
| 8.1 | Correct installation of the GO-Box..... | 83 |
| 8.2 | Correct operation of the GO-Box..... | 84 |
| 8.2.1 | Parts of the GO-Box..... | 84 |
| 8.2.2 | Declaring and setting the vehicle category (not applicable for buses and motor caravans) | 84 |
| 8.2.3 | Declaring and setting the vehicle category (buses and motor caravans)..... | 85 |
| 8.2.4 | Checking that the GO-Box is in working order | 85 |
| 9 | MONITORING PAYMENT OF THE MANDATORY TOLL | 88 |
| 9.1 | Toll enforcement officers and their powers | 88 |
| 9.2 | Toll enforcement officers' identification cards | 89 |
| 9.3 | Toll enforcement officers' vehicles | 90 |
| 10 | Toll Evasion | 90 |
| 10.1 | Penalties for toll evasion..... | 90 |
| 10.2 | Non-imposition of a penalty | 90 |
| 10.3 | Substitute toll | 91 |
| 10.3.1 | Method of payment..... | 91 |
| 10.3.2 | Substitute toll rate..... | 91 |
| 10.3.3 | Initiation of administrative penal proceedings | 92 |
| 11 | VIOLATION OF THE OBLIGATION TO STOP | 92 |
| 12 | PLACE OF JURISDICTION AND APPLICABLE LAW | 92 |
| 13 | COMPETENCE AND CUSTOMER SERVICE..... | 93 |
| PART C: | INTEROPERABILITY..... | 94 |
| 1 | THE AUTHORISATION OF ON-BOARD UNITS USED FOR THE SWISS LSWA TOLL SYSTEM..... | 94 |
| 1.1 | General remarks..... | 94 |
| 1.2 | Provisions relating to the on-board unit | 94 |
| 1.3 | Registration..... | 95 |
| 1.3.1. | Registration procedure | 95 |
| 1.3.2. | Declaration of the EURO emission class and changing data..... | 95 |
| 1.4 | Data transfer | 95 |
| 1.5 | The driver's obligations | 96 |

| | | |
|---------|--|-----|
| 1.5.1. | The correct installation and operation of the on-board unit and the setting of the category in the on-board unit | 96 |
| 1.5.2. | Checking that the on-board unit is in working order | 96 |
| 1.6 | Signals emitted by the on-board unit | 96 |
| 1.7 | Deregistering from the system..... | 97 |
| 2 | DUAL CONTRACT INTEROPERABILITY WITH GERMANY ('TOLL2GO') | 97 |
| 2.1 | General remarks..... | 97 |
| 2.2 | Requirements for using the service in Austria | 97 |
| 2.3 | Registration..... | 98 |
| 2.3.1. | Registering for the first time | 98 |
| 2.3.1.1 | <i>Registration procedure</i> | 98 |
| 2.3.2. | Switching from an Austrian GO-Box to the TC OBU..... | 99 |
| 2.3.2.1 | <i>Registration procedure</i> | 99 |
| 2.3.2.2 | <i>Obligation to return the GO-Box</i> | 100 |
| 2.3.3. | Declaration of the relevant EURO emission class | 100 |
| 2.3.4. | Vehicle declaration | 101 |
| 2.4 | Right to refusal..... | 102 |
| 2.5 | The storage and exchange of data | 102 |
| 2.6 | Data changes..... | 102 |
| 2.7 | The sale or rental of vehicles..... | 103 |
| 2.8 | Provisions relating to the TC OBU..... | 104 |
| 2.9 | GO points of sale | 104 |
| 2.10 | Deregistering the TC OBU..... | 105 |
| 2.11 | Retroactive toll payment | 105 |
| 2.12 | The driver's obligations..... | 106 |
| 2.12.1. | The correct installation and operation of the TC OBU and setting the category in the TC OBU..... | 106 |
| 2.12.2. | Checking that the TC OBU is in working order | 106 |
| 2.12.3. | Acoustic signals emitted by the TC OBU | 106 |
| 3 | THE AUTHORISATION OF ON-BOARD UNITS ACTIVATED FOR THE EASYGO+ SERVICE | 107 |
| 3.1 | General remarks..... | 107 |
| 3.2 | Provisions relating to the on-board unit (hereinafter referred to as the EasyGo+ OBU) | 108 |
| 3.3 | Registering with and de-registering from the EasyGo+ service..... | 108 |
| 3.4 | The storage and exchange of data..... | 109 |
| 3.4.1. | Correct toll payment with the EasyGo+ OBU | 109 |
| 3.4.2. | Incorrect toll payment with the EasyGo+ OBU | 109 |
| 3.5 | Obligations..... | 109 |
| 3.5.1. | Vehicle declaration | 109 |
| 3.5.2. | Installation and operation of the EasyGo+ OBU..... | 110 |
| 3.5.3. | Declaring and setting the category..... | 110 |
| 3.5.4. | Checking that the EasyGo+ OBU is in working order | 110 |
| 3.5.5. | Acoustic signals emitted by the EasyGo+ OBU | 110 |
| 3.6 | Retroactive toll payment | 111 |
| 3.7 | Responsibilities and services..... | 112 |
| 3.7.1. | Toll service providers | 112 |
| 3.7.2. | GO points of sale..... | 112 |
| 3.7.3. | ASFINAG SERVICE CENTER (ASC) | 112 |
| 3.7.4. | Special features..... | 112 |
| 3.8 | Using the 'local' Austrian GO-Box..... | 113 |
| 4 | THE AUTHORISATION OF ON-BOARD UNITS FOR TOLL PAYMENT IN AUSTRIA WITHIN THE SCOPE OF THE "REGIONAL EUROPEAN ELECTRONIC TOLL SERVICE" ("REETS")..... | 113 |
| 4.1 | General remarks..... | 113 |
| 4.2 | Provisions relating to the on-board unit (REETS OBU)..... | 114 |

| | | |
|--------|--|-----|
| 4.3 | Registration with and de-registration from REETS | 114 |
| 4.4 | The storage and exchange of data | 114 |
| 4.4.1. | Correct toll payment with the REETS OBU | 115 |
| 4.4.2. | Incorrect toll payment with the REETS OBU | 115 |
| 4.5 | Obligations | 115 |
| 4.5.1. | Vehicle declaration | 115 |
| 4.5.2. | Installation and operation of the REETS OBU | 116 |
| 4.5.3. | Declaring and setting the category | 116 |
| 4.5.4. | Checking that the REETS OBU is in working order | 116 |
| 4.5.5. | Acoustic signals emitted by the REETS OBU | 116 |
| 4.6 | Retroactive toll payment | 117 |
| 4.7 | Responsibilities and services | 118 |
| 4.7.1. | Service provider | 118 |
| 4.7.2. | GO points of sale | 118 |
| 4.7.3. | ASFINAG SERVICE CENTER (ASC) | 118 |
| 4.7.4. | Special features | 119 |
| 4.8 | Using the 'local' Austrian GO-Box | 119 |
| 5 | EUROPEAN ELECTRONIC TOLL SERVICE (EETS) | 119 |

PREAMBLE

The rights of usufruct over all motorways and expressways in Austria were granted to Autobahnen- und Schnellstraßen-Finanzierungs-Aktiengesellschaft (ASFINAG) with the signing of the Usufruct Agreement concluded by virtue of the ASFINAG Authorisation Act 1997, BGBl. (Federal Official Gazette) I No. 113/1997. Consequently, ASFINAG has the right to collect tolls from all drivers who use the federal highways or sections thereof that are the object of this usufruct. ASFINAG is a public limited company that was established by virtue of the ASFINAG Act, BGBl. No. 591/1982. The shares in ASFINAG are held in their entirety by the Republic of Austria.

1. In accordance with the provisions of the Federal Road Tolls Act 2002 (BStMG), BGBl. I No. 109/2002 (unless expressly indicated otherwise, all references to Acts relate to the respective Act as amended), ASFINAG has the right to collect either a time-related toll or a distance-related toll from the users of all motorways and expressways, depending on the maximum gross vehicle weight of the vehicle. A mandatory toll is also levied on all areas that are part of a federal highway in accordance with section 3 of the Federal Highways Act 1971.

In accordance with section 14(1) BStMG, ASFINAG is obliged to draw up Tolling Regulations containing provisions governing the use of motorways and expressways on which tolls are levied. The present Tolling Regulations contain the following:

- general provisions for the payment of the **time-related toll** levied on vehicles with a maximum gross vehicle weight of up to 3.5 t (**Tolling Regulations Part A I**), whereby the collection of tolls and/or the operative tasks associated with toll collection (e.g. vignette service centre, vignette production, vignette sales etc.) will be executed by ASFINAG Maut Service GmbH, Alpenstraße 99, A-5020 Salzburg, Austria, on behalf of and for the account of ASFINAG, and
 - general provisions for the payment of the **distance-related toll** levied on vehicles with a maximum gross vehicle weight of more than 3.5 t (**Tolling Regulations Part B**), whereby the fully electronic toll system shall be operated by and the distance-related toll collected by ASFINAG Maut Service GmbH, Alpenstraße 99, A-5020 Salzburg, Austria, on behalf of and for the account of ASFINAG.
2. By decree of the Federal Minister of Transport, Innovation and Technology in agreement with the Federal Minister of Finance, the general provisions and toll charges relating to the section toll for the toll road sections on the A 9, A 10, A 11, A 13, and S 16 are adopted with regard to ASFINAG. The laws governing the collection of road section tolls will hereinafter be explained for each of the existing toll road sections.

A 9 Pyhrn motorway: The toll will be collected between the Spital/Pyhrn and Ardning junctions and between the St. Michael intersection and the Übelbach junction. This toll road section is divided into two separate subsections and includes the Bosruck and

Gleinalm tunnels. The authorisation to collect a charge is regulated by section 2(1) of the Pyhrn Motorway Financing Act, BGBl. No. 479/1971.

A 10 Tauern motorway: The toll will be collected between the Flachau and Rennweg junctions. This toll road section includes the Tauern and Katschberg tunnels. The authorisation to collect a charge is regulated by section 2(1) of the Tauern Motorway Financing Act, BGBl. No. 115/1969.

A 11 Karawanken motorway: The toll will be collected on the A 11 southbound between the St. Jakob/Rosental junction and the southern tunnel entrance (in Slovenia). In conformity with the provisions of the State Treaty on the Karawanken Tunnel (BGBl. 441/1978), the toll is only levied on the southbound carriageway on the Austrian side of the border. The toll on the northbound carriageway is levied on the Slovenian side of the border. The authorisation to collect a charge is regulated by Article 12 of the aforementioned Treaty and section 2 of the Karawanken Motorway Financing Act, BGBl. No. 442/1978.

A 13 Brenner motorway: The toll will be levied between the Innsbruck-Amras/Innsbruck-Wilten intersection and the national border on the Brenner Pass. The authorisation to collect a charge is regulated by section 1(1) of the Innsbruck–Brenner Motorway Financing Act, BGBl. No. 135/1964.

S 16 Arlberg expressway: The toll will be collected between the St. Anton am Arlberg and Langen/Arlberg junctions. This section toll segment includes the Arlberg tunnel. The authorisation to collect a charge is regulated by section 2(1) of the Arlberg Expressway Financing Act, BGBl. No. 113/1973.

The road section toll will be collected by ASFINAG Maut Service GmbH, Alpenstraße 99, A-5020 Salzburg, Austria, on behalf of and for the account of ASFINAG. In accordance with Tolling Regulations Part A II, the toll will be levied on vehicles with a maximum gross vehicle weight of up to 3.5 t. The Federal Road Tolls Act 2002 and the provisions of Tolling Regulations Part B apply to vehicles with a maximum gross vehicle weight of more than 3.5 t.

3. Tolling Regulations Parts A I and B are formally approved by the Federal Minister of Transport, Innovation and Technology in agreement with the Federal Minister of Finance in accordance with section 14(2) BStMG; Tolling Regulations Part A II was adopted with regard to ASFINAG by the Federal Minister of Transport, Innovation and Technology in agreement with the Federal Minister of Finance.

PART A I: TOLLING REGULATIONS FOR VEHICLES WITH A MAXIMUM GROSS VEHICLE WEIGHT OF UP TO 3.5 t

1. GENERAL REGULATIONS

1.1 DEFINITION OF TERMS

- **vignette:** If in the following the term “vignette“ is being used, it covers the toll sticker as well as the digital vignette.
- **valid vignette:** The toll is, in case there is no exemption according to section 2.2.2, properly paid if during the use of the toll road network a toll sticker (according to the vehicle type) is properly attached to the vehicle or the license plate number (according to its vehicle type) is properly registered in the toll system (digital vignette).
- **order confirmation:** The document issued when a digital vignette has been obtained (registration in the toll system). This document particularly shows data of the license plate number registered in the toll system, vehicle type, validity period as well as the product-ID, which serves to clearly identify the digital vignette.
- **allonge:** The lower section of the toll sticker (backing paper/ toll sticker tab).
- **registering the vehicle’s license plate number in the toll system:** Obtaining the digital vignette.
- **type of vignette:** A vehicle related differentiation between vignettes for single-track vehicles and twin-track vehicles with a maximum gross vehicle weight of up to 3.5 tonnes.
- **ASFINAG app:** If in the following the term ASFINAG app is being used, the ASFINAG app „Unterwegs“ is meant.
- **vignette registry:** This term is used to define the publicly accessible registry on www.asfinag.at, which can be visited by any person without any costs, to view whether a license plate number is already registered in the toll system and therefore owns a digital vignette or a digital section toll ticket and for what time period it is valid.
- **type of vehicle:** Hereby a differentiation between single-track vehicles and twin-track vehicles with a maximum gross vehicle weight of up to 3.5 tonnes is made.

1.2 SCOPE OF APPLICATION

Tolling Regulations Part A I applies to all vehicles with a maximum gross vehicle weight of up to 3.5 t. These vehicles are liable for a time-related toll (vignette). Unless expressly indicated otherwise, all references to individual sections contained in Part A I of the Tolling Regulations relate specifically to sections in Part A I of the Tolling Regulations.

Vehicles with three wheels are always considered to be twin-track vehicles. No time-related toll must be paid for trailers being towed by twin-track vehicles with a maximum gross vehicle weight of up to 3.5 t or for sidecars attached to single-track vehicles.

Drivers of twin-track vehicles that have not yet been registered and carry trade plates are obliged to pay the time-related toll as long as the service weight of their vehicle does not exceed 3.5 t. When driving a vehicle with trade plates, drivers must carry a copy of the vehicle’s logbook or evidence of the service weight of the vehicle provided by the car manufacturer or his authorized

representative in accordance with section 29(2) of the Motor Traffic Act. The driver must present this evidence on request. If evidence of this kind cannot be presented on request, the twin-track vehicle in question shall be considered a vehicle with a service weight of more than 3.5 t.

1.3 MANDATORY VIGNETTE

1.3.1 Network of roads on which tolls are levied

Unless exemptions apply, a time-related toll must be paid for vehicles that are liable for the toll for the use of the motorways and expressways:



Illustration 1

Toll roads in Vienna:



Illustration 2

All extensions of the toll road network must be specified and published in appendix 4 (toll rates per road section net). The time-related toll must be paid for these extensions as soon as they come into effect.

In accordance with section 10(2) BStMG, the following sections of motorway and expressway are excluded from the mandatory time-related toll system (see Tolling Regulations Part A II):

- the section of the A 9 Pyhrn motorway between the Spital/Pyhrn and Ardning junctions and between the St. Michael intersection and the Übelbach junction;
- the section of the A 10 Tauern motorway between the Flachau and Rennweg junctions;
- the section of the A 11 Karawanken motorway between the St. Jakob im Rosental junction and the national border in the Karawanken tunnel;
- A 13 Brenner motorway
- the section of the S 16 Arlberg expressway between the St. Anton and Langen junctions.

In accordance with the Ordinance issued by the Federal Minister for Transport, Innovation, and Technology on the exemption of federal road sections from the mandatory toll (Toll Road Section Exemption Ordinance 2010), the following sections of motorway or expressway are excluded from the mandatory time-related toll system:

- the section of the S 5 Stockerauer expressway between the Jettsdorf intersection (S 33) and the Krems junction (regional highway B 3, regional highway B 37).

1.3.2 Signing

Information signs on federal and regional highways leading to national border crossings for motor vehicle traffic notify road users of the obligation to have a valid vignette (see illustrations 3 and 4). The mandatory vignette on toll roads is also indicated on additional information signs on approach roads (see illustration 5).



Illustration 3*



Illustration 4*



Illustration 5*

(*The 'GO' symbol refers to the toll for which vehicles with a maximum gross vehicle weight of more than 3.5 t are liable, see Tolling Regulations Part B for details)

1.3.3 Exemptions from the mandatory vignette

1.3.3.1 Permanent exemptions

The following vehicles are exempt from the mandatory vignette:

- Vehicles with visible blue headlights or warning lights in accordance with section 20(1)(4) and (5) of the Motor Traffic Act 1967 (hereinafter referred to as 'KFG' for short). In the cases of vehicles in accordance with section 20(5) KFG, an exemption from the mandatory toll exists only for the time of using the blue headlights or warning lights and if the usage complies with the restrictions and conditions given in section 20(6) KFG. The return journey of an operational vehicle, which used blue headlights or warning lights, is also exempt from the mandatory vignette.
- Army vehicles (section 2(1)(38) Motor Traffic Act 1967).
- Vehicles that are used within the scope of the agreement among the states party to the North Atlantic Treaty and the other states participating in the Partnership for Peace regarding the status of their forces ('PfP-SOFA'). If non-military vehicles are used for these trips, they shall provisionally be subject to the provisions of the time-related toll. The toll paid in the course of these trips will be refunded by ASFINAG free of charge. Applications for refunds must be submitted by the relevant state authorities once the trips have been completed. Refund applications must be accompanied by evidence that the toll was paid and submitted directly to ASFINAG Maut Service GmbH (see appendix 7a).
- Vehicles that are used for the implementation of measures for securing peace within the scope of an international organisation, the Organisation for Security and Co-operation in Europe, or the European Union in conformity with a Decision made within the scope of the Common Foreign and Security Policy. If non-military vehicles are used for these trips, they shall provisionally be subject to the provisions of the time-related toll. The toll paid in the course of these trips will be refunded by ASFINAG free of charge. Applications for refunds must be submitted by the relevant state authorities once the trips have been completed. Refund applications must be accompanied by evidence that the toll was paid and submitted directly to ASFINAG Maut Service GmbH (see information in section 1.13).
- Vehicles belonging to the public security forces, tax authorities, prison services, and foreign security forces in accordance with section 2(3) of the Police Co-operation Act, as well as vehicles belonging to foreign customs and judicial authorities. Confiscated vehicles that use the toll road network and to which an official tax authority registration number has been attached are not liable for the toll.
- Vehicles belonging to foreign public emergency services, foreign fire brigades or foreign rescue services. These vehicles are only exempt from the mandatory toll if the blue headlights or warning lights have been visibly attached to the exterior of these vehicles and only for the time these blue headlights or warning lights are used.

Vehicles that have blue headlights or warning lights visibly attached to the exterior, but are not registered and carry therefore trade plates or other equivalent plates and that use the toll road network are not exempt from the mandatory toll.

Autobahnen- und Schnellstraßen-Finanzierungs-Aktiengesellschaft must provide free vignettes for army vehicles (section 2 sub-paragraph 38 Motor Traffic Act 1967), vehicles belonging to the public security forces, tax authorities, and the prison services that have been allocated special licence plate numbers ('Deckkennzeichen') in accordance with section 48(1) Motor Traffic Act 1967.

In cases of doubt ASFINAG has the right to demand further proof for the above mentioned requirements for an exemption.

1.3.3.2 Temporary exemptions

1.3.3.2.1 *Urgent traffic restrictions*

In the event of an urgent traffic restriction within the meaning of section 44b(1) of the Road Traffic Act (StVO), BGBl. No. 159/1960 on a non-trunk road network, vehicles that are directed by officers of the road inspection authorities, road maintenance units, fire brigade, public breakdown service, or waste disposal companies to use sections of a motorway or expressway as part of the diversion route are not obliged to have a valid vignette on the motorway or expressway. Vehicles without a valid vignette must leave the motorway or expressway at the next possible exit.

1.3.3.2.2 *Exceptions for vehicles delivering humanitarian aid*

In addition to the above provision, ASFINAG may in accordance with section 5(2) BStMG and depending on the circumstances, exempt vehicles with a maximum gross vehicle weight of up to 3.5 t that are delivering humanitarian aid in the event of emergencies or disasters from paying the mandatory toll.

To obtain such an exemption, which allows a trip to be completed without payment of the toll (i.e. the attachment of a toll sticker in accordance with section 2 or registering the vehicle's license plate number in the toll system in accordance with section 3), an exemption application form in accordance with appendix 3a (which can be downloaded at www.asfinag.at) must be completed, properly signed, and returned to ASFINAG either by e-mail to info@asfinag.at or by fax to +43 1 955 12 77 at least 24 hours before use of the toll road network. The applicant will receive confirmation. This confirmation must be carried in the vehicle for the duration of the trip that is exempt from the mandatory toll and must be presented on request as evidence of exemption approval.

This provision applies exclusively to those cases that result from a cause within the meaning of section 5(2) of the Federal Road Tolls Act and is announced at this point in the Toll Regulations.

1.4 VIGNETTE PRICES

The vignette prices are defined in an Ordinance issued by the Federal Minister of Transport, Innovation and Technology in consent with the Federal Minister of Finance. The valid vignette prices are quoted in appendix 1 and vary according to the type of vehicle and the duration of use. Prices include 20 % VAT.

1.5 DURATION OF ENTITLEMENT OF USE

The validity period of the toll sticker and the digital vignette is the same. The validity period of a toll sticker can be visually verified, whereas the validity of a digital vignette can be checked (free of charge) by retrieving the vehicle's license plate number in the vignette registry.

1.5.1 Annual vignette

The annual toll sticker is valid for the year indicated on the toll sticker. Furthermore, it may be used from 1 December of the year preceding and until 31 January of the year following the year indicated on the toll sticker (see appendix 1).

When using the digital annual vignette the validity period will be indicated, besides the query of the vignette registry, on the (latest valid) order confirmation, issued after registering the vehicle's licence plate number in the toll system.

1.5.2 Two-month vignette

The two-month vignette entitles the bearer to use the roads for two months, from the first day of validity. The first day of validity can be chosen within the validity period (for possible restrictions regarding the two-month digital vignette see section 3.2.1.1).

When using a two-month toll sticker the first day of validity will be marked by a hole in the appropriate starting day in accordance with the toll sticker samples (see appendix 1). The hole will be punched by the seller at the toll sticker sales outlets.

In case of using a two-month digital vignette the validity period will be indicated, besides the query of the vignette registry, on the (latest valid) order confirmation, generated after registering the vehicle's license plate number in the toll system.

This toll sticker expires at the end of the day of the second month that corresponds to the date on which the toll sticker came into effect (= first day of validity) or, if no such date exists in that month, at the end of the last day of the second month (see appendix 1).

The last day in a calendar year from which onwards the two-month vignette is valid, is the 30th of November. On the basis of the two-month period of validity, this two-month vignette may only be used until January 30 of the following year. In case a two-month vignette should have its first day of validity in December of any calendar year, only a two-month vignette of the following calendar year can be purchased.

1.5.3 Ten-day vignette

The ten-day vignette entitles the bearer to use the roads from the first day of validity for ten successive calendar days, whereby the first day of validity can be freely chosen within the validity period (for special restrictions regarding the ten-day digital vignette see section 3.2.1.1).

When using a ten-day toll sticker the first day of validity will be marked by a hole in the appropriate starting day in accordance with the toll sticker samples (see appendix 1). The hole will be punched by the seller at the toll sticker sales outlets.

In case of using a ten-day digital vignette the validity period will be indicated, besides the query of the vignette registry, on the (latest valid) order confirmation, generated after registering the vehicle's license plate number in the toll system.

The last day in a calendar year from which onwards the ten-day vignette is valid, is the 30th of November. On the basis of the ten-day period of validity, this ten-day toll sticker may only be used until December 9 of the same calendar year. In case a ten-day vignette has its first day of

validity in December of any calendar year, only a ten-day vignette of the following calendar year can be purchased.

1.6 RELIEF MEASURES FOR DISABLED DRIVERS

ASFINAG provides disabled people with vignettes free of charge upon presentation of evidence that the following conditions are fulfilled. To this end, ASFINAG Maut Service GmbH (see information in section 1.13) shall provide the Federal Agency for Social Matters and the Disabled with the required number of annual vignettes for the subsequent calendar year free of charge.

The Federal Agency for Social Matters and the Disabled provides disabled people

- who are resident in or ordinarily resident in Austria,
- in whose name at least one twin-track vehicle with a maximum gross vehicle weight of up to 3.5 t has been registered,
- who are in possession of a disabled person's identity card in accordance with section 40 of the Federal Disabled Persons Act, on which one of the following disabilities has been noted: a long-term, serious walking disability; chronic ill-health; a permanent mobility impairment due to a disability that means the card holder cannot reasonably be expected to use public transport; blindness,

with a free annual vignette for the aforementioned vehicle for every calendar year, namely through providing an annual toll sticker or, if the applicant has requested a digital annual vignette, a registration code.

The Federal Agency for Social Matters and the Disabled is authorized to issue disabled person's identity cards to disabled people who do not belong to the category of people defined in section 40(1)(1–5) of the Federal Disabled Persons Act. Should more than one vehicle be registered in the name of the applicant, the free vignette may only be issued for one of these vehicles.

The Handling of the application of free vignettes plus the sending will be provided centrally by the regional office of Lower Austria of the Federal Agency for Social Matters and the Disabled.

There are relief measures concerning the section toll, described in Part A II (see sections 3.2.3 Annual card with vignette credit, 3.2.4 Annual card for commuters, 3.3.6 Annual card for disabled drivers on the A 13, and 3.2.8 Resident's card for the A 13).

1.6.1 Replacement of the vignette

If a disabled person has been issued with a free annual vignette for a specific vehicle by the Federal Agency for Social Matters and the Disabled, and the vignette has lost its validity (e.g. due to a broken windscreen, destruction of the person's vehicle respectively change of vehicle or license plate number) the disabled person has the right to request a new, free annual vignette from ASFINAG Maut Service GmbH (see information in section 1.13) for the remaining validity period of the originally assigned annual vignette, again.

The application form as well as the following evidence/documents must be submitted to ASFINAG Maut Service GmbH:

- evidence that the applicant has already received a free annual vignette for the current calendar year in the form of a confirmation from the Federal Agency for Social Matters and the Disabled;
- the removed annual toll sticker including the lower section (toll sticker tab and/or backing paper) respectively the product-ID of the digital vignette;
- confirmation from the vehicle registration unit that the vehicle for which the Federal Agency for Social Matters and the Disabled has already issued a free annual vignette has been removed from the register;
- a copy of the vehicle registration document of the new vehicle belonging to the holder of the disabled person's identity card.

If a digital annual vignette that is valid for 2018 is being changed in accordance with section 11 (5) BStMG (see 3.6), the disabled person has the right to request – meeting the above mentioned requirements – a refund of the reimbursement of expenses (that has been paid for the change) from ASFINAG Maut Service GmbH (see point 1.13).

In cases of doubt ASFINAG has the right to demand further documents of proof (e.g. a copy of the entry in the applicant's disabled person's identity card in accordance with section 40 of the Federal Disabled Persons Act).

1.6.2 Non-provision of a free annual vignette in time

If the free annual toll sticker or the registration code for the annual digital vignette is not delivered to the applicant in time and the applicant is obliged to purchase a corresponding annual vignette, he or she may request a refund of the purchase price of the annual vignette from ASFINAG Maut Service GmbH (see information in section 1.13) by submitting the documents listed below:

- a copy of the vehicle registration documents of the disabled person's identity card holder;
- the original confirmation from the Federal Agency for Social Matters and the Disabled that the annual toll sticker or the registration code could not be sent to the applicant in time;
- receipt of the in advance purchased annual toll sticker respectively the allonge or the product-ID of the digital annual vignette.

In cases of doubt ASFINAG has the right to demand further documents of proof (e.g. a copy of the entry in the applicant's disabled person's identity card in accordance with section 40 of the Federal Disabled Persons Act).

1.7 OBLIGATIONS

Before using the toll road network with a vehicle that is liable for the toll, every driver has to make sure that, for the period of the intended use of the toll road network, the time-related toll has properly been paid for (in advance). This includes checking if the toll has properly been paid by using the correct type of vignette, according to the vehicle type.

In case of using a toll sticker to pay the toll, the bearer has to visually check if the toll sticker is attached in the correct location, it is attached properly (if carrying an unattached toll sticker is not explicitly permitted, see section 2.2.2), and that it is “intact” as well as visible and verifiable.

In case of using a digital vignette the driver needs to make a query in the vignette registry (see point 1) immediately before using the toll road network. This will give him or her an indication whether the vehicle has a digital vignette (or more, if more than one digital vignette has been purchased) and for what time period it is (or they are) valid.

Furthermore, every vehicle driver has to – according to section 102(2) KFG – make sure that the official license plate number of the vehicle that is liable for toll, is completely and permanently visible during the journey and has not been covered by dirt or snow, respectively damaged deformed in such a way that it is illegible.

If the time-related toll has not been properly paid for in advance, the driver is not permitted to use the toll road network, otherwise this will result in a toll evasion offence in accordance with section 1.9.

1.8 MONITORING OF THE MANDATORY VIGNETTE

1.8.1 Inspection by road inspection authorities and toll enforcement officers

In accordance with sections 17 et seq. BStMG, payment of the time-related toll is monitored by the officers of the road inspection authority and toll enforcement officers.

Toll enforcement officers are public inspection officers. They are nominated by ASFINAG and are appointed and sworn in to the job by the local district administrative authorities. When discharging their duties, toll enforcement officers must carry with them the identification card defined below and show it to the person concerned when requested to do so.

The identification card for toll enforcement officers, which confirms their official status, is the size of a cheque card, is printed on both sides, and features the following in particular: a photograph and the name, and duty number of the toll enforcement officer (see illustration 6).



Illustration 6

The toll enforcement officers’ vehicles are public security force enforcement vehicles that comply with section 20(1)(4) lit.a of the Motor Vehicle Act 1967. These vehicles are silver-grey operational vehicles that are equipped with flashing blue lights and a siren. Furthermore, they are marked with the following words: ‘ASFINAG’, ‘Mautaufsicht’ (toll enforcement) and ‘Service- und Kontrolldienst der ASFINAG’ (ASFINAG customer service and toll enforcement unit). See illustration 7 for details.



Illustration 7

In order to monitor the correct payment of tolls, toll enforcement officers are authorized, among other things, to use clearly visible and audible signals to request drivers to stop; to stop these drivers; to inspect the attachment of the toll sticker respectively the registration of the license plate number in the toll system; to determine the identity of the driver and the registered owner; to inspect the vehicle (in particular the vehicle registration documents), to inspect evidence of the service weight of a vehicle carrying trade plates in accordance with section 1.2 (in particular a copy of the vehicle's logbook); and to verbally request the apprehended driver to pay the substitute toll.

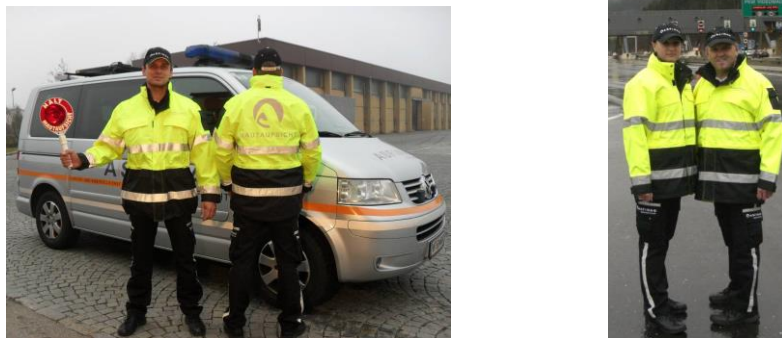

Illustration 8

Moreover, in order to monitor the correct payment of tolls and to conduct traffic surveys, toll enforcement officers are authorized to use automatic traffic diversion equipment to divert traffic to toll inspection areas. Toll inspection areas are currently situated at the following locations:

A1 Eberstalzell, A1 Haag, A1 Walserberg, A2 Arnoldstein, A2 Arnwiesen, A2 Haimburg, A2 IlztaI, A6 Kittsee, A4 Bruck/Leitha, A4 Nickelsdorf, A4 Gols, A4 Zurndorf, A8 Kematen, A8 Suben, A9 Schoberpaß, A9 Straß, A10 Hoher Göll, A10 Kellerberg, A11 Rosegg, A11 Karawankentunnel, A12 inspection bay Roppener Tunnel Ostportal, A12 inspection bay Zirl Ost, A12 junction Wörgl-Ost, A14 Hörbranz, A14 Nüziders, S4 Pöttsching, S3 Göllersdorf, S16 "Kettenanlegeplatz" (a place where drivers can attach snow chains to the tires) Bings, S31 Hirm Nord, S31 Hirm Süd and S37 Maria Saal.

Additionally, toll enforcement officers may also monitor the correct payment of tolls and conduct traffic surveys at border crossings and junctions.

If no substitute toll is paid and if prosecution or execution of a sentence appear obviously impossible or very difficult, the toll enforcement officers are authorized in accordance with section 27 BStMG to request provision of a provisional security deposit or, if the stipulated provisional security deposit is not provided, to request that the trip be interrupted and prevent its

continuation by taking suitable preventative measures (e.g. confiscation of vehicle documents and keys, clamping of the vehicle, parking it in a suitable place and other similar measures) in accordance with section 28 BStMG.

1.8.1.1 Inspection of the moving traffic (on inspection areas and junctions)

Whether the toll has been paid or not will be examined by the toll enforcement officers by a visual inspection (toll sticker) as well as by the help of technical devices (digital vignette) on the spot.

For that particular purpose a camera will be placed at the roadside (on the access or exit of a motorway or expressway on which toll is being levied or on traffic inspection areas) and adjusted towards the driving lane. The license plate numbers of all passing vehicles will be captured to verify whether they have a valid digital vignette or not.

The result of this examination will be indicated to the toll enforcement officer via a mobile display device. Subsequently, the toll enforcement officer may visually verify if the vehicle has a valid toll sticker properly attached to the vehicle.

1.8.1.2 Inspection of the stationary traffic

Besides the inspection of the moving traffic, there are also mobile inspections of the stationary traffic (e.g. on resting areas). The toll enforcement officer visually examines whether a toll sticker has been attached properly onto the vehicle. If this is not the case, the toll enforcement officer will verify if a digital vignette has been acquired for the vehicle.

1.8.2 Automatic monitoring of vignettes

The automatic monitoring of vignettes (AVK) is carried out in accordance with the requirements of the BStMG and is registered with the Data Processing Register. It is a mobile electronic system that selectively monitors whether tolls have been correctly paid. The AVK is used at constantly changing locations across Austria for a limited period at each location.

The AVK uses special software to check the windscreens of passing vehicles concerning attached toll stickers respectively the passing vehicle's license plate numbers, to examine whether the license plate number has been registered in the toll system. The system is capable of identifying the validity of toll stickers and only stores images of vehicles which are suspected of not having paid the time-related toll properly (suspicion of toll evasion in accordance with section 20 BStMG, see also section 10 below). Cases not considered suspicious will not be stored for statistical or other purposes once the monitoring process is complete.

The suspicious case stored in relation to the automatic monitoring will subsequently be checked and verified by caseworkers of ASFINAG Maut Service GmbH. Manual processing involves performing several checks. If the suspicious case is confirmed, proceedings to ensure payment of a substitute toll will be initiated.

1.9 TOLL EVASION

1.9.1 Penalties for toll evasion

It is prohibited to drive a vehicle that is liable for the toll within the meaning of Tolling Regulations on the toll road network without a valid toll sticker that has either been properly attached to the vehicle or properly carried in the vehicle in accordance with section 2.2.2 of Tolling Regulations Part A (respectively acquired a valid digital vignette). In accordance with section 20(1) BStMG, drivers who violate this prohibition are in breach of an administrative rule and may be fined between **€ 300.00** and **€ 3,000.00** by the local district administrative authorities.

1.9.2 Non-imposition of a penalty

A penalty is not imposed if the driver pays a substitute toll, which is defined below. A substitute toll, which is paid in due time and in proper form, cannot be reclaimed.

1.9.3 Substitute toll

1.9.3.1 Method of payment

The substitute toll may not be paid in instalments. If instalments are received, they will be credited to the payer's account minus a processing fee of € 15.00 (including 20 % VAT). The same applies to late payments, payments that do not include the correct identification number (ID no.), or any payments made to any account other than the one indicated on the copy of the request to pay the substitute toll. In the event of overpayment by less than € 5.00, no money will be credited to the payer's account (otherwise the entire amount will be credited to the payer's account).

1.9.3.1.1 *Apprehension by toll enforcement officers*

If the driver of the vehicle is apprehended by toll enforcement officers, the toll enforcement officer is authorized to verbally request that the driver pay the substitute toll. The substitute toll must be paid immediately upon request either in cash or using an authorized means of payment mentioned in appendix 2 of the tolling regulation. The driver will be given confirmation of payment.

1.9.3.1.2 *Discovery of a violation in the absence of the driver*

If a violation is discovered by toll enforcement officers during the course of their work without the driver being apprehended in person (e.g. because the driver is not at the vehicle), a written request to pay the substitute toll may be left at the vehicle.

This written request will provide details of the substitute toll to be paid, an identification number (ID No.), and details of a bank account.

The substitute toll must be transferred to the account indicated in the written request and must include the identification number (ID No.) given thereon. The obligation to pay the substitute toll is met when the substitute toll has been credited to the given account within two weeks of the request to pay the substitute toll being left at the vehicle and as long as the transfer order

contains the complete and correct identification number, which must be written in such a way that it can be automatically read by a machine.

1.9.3.1.3 *Retroactive summons procedure*

If a violation is discovered by means of automatic monitoring of vignettes without the driver being apprehended in person, the registered owner(s) may receive a written request to pay the substitute toll.

This written request will provide details of the substitute toll to be paid, an identification number (ID No.), and details of a bank account.

The substitute toll must be transferred to the account indicated in the written request and must include the identification number (ID No.) given thereon. The obligation to pay the substitute toll is met when the substitute toll has been credited to the given account within four weeks of the issuing of the request and as long as the transfer order contains the complete and correct identification number, which must be written in such a way that it can be automatically read by a machine.

1.9.3.2 Substitute toll rate

The substitute toll rates (including 20 % VAT) for non-payment of the time-related toll are given below:

| Vehicle category | Substitute toll rate |
|--|----------------------|
| A (i.e. single-track vehicles) | € 65.00 |
| B (i.e. twin-track vehicles a maximum gross vehicle weight of up to 3.5 t) | € 120.00 |

If a toll sticker has not been attached properly to the vehicle (see point 2.2.) and has been manipulated either by chemical or technical means in such a way that the toll sticker is prevented from self-destruction upon removal or multiple use can not be excluded, the price of the substitute toll will be doubled for each category (see table above).

1.9.3.3 Continuing the journey with a substitute toll receipt or payment slip

Payment of the substitute toll authorises the driver of the vehicle to use the toll road network on the day he or she was apprehended and/or the day on which the payment slip was left on his or her vehicle and on the following day. Either the receipt issued after the driver was apprehended or the payment slip attached to the written request to pay the substitute toll are considered to be proof of payment of the substitute toll. Failure to comply with this provision constitutes a toll evasion offence.

Drivers who refuse to pay the toll after being apprehended are obliged to leave the toll road immediately at the next possible exit.

Upon leaving the vehicle, the driver must ensure that the receipt or the payment slip is placed inside the windscreen in such a way that the entitlement of use (especially the location, date, and time of issue and the vehicle's license plate number) can easily be seen and inspected from outside the vehicle. Failure to comply with this provision constitutes a toll evasion offence.

1.9.3.4 Payment of the substitute toll

Substitute tolls must be paid in euros. Information regarding the means and methods of payment that are accepted for payment of the substitute toll to toll enforcement officers is given in appendix 2 and on the Internet at www.asfinag.at. This information may also be obtained from customer services (see information in section 1.13).

1.10 VIOLATION OF THE OBLIGATION TO STOP

Drivers who, contrary to section 18(2) BStMG, do not stop when requested to do so by an officer defined in section 1.8.1 are in breach of an administrative rule contrary to section 21 BStMG and must be fined up to **€ 3,000.00**.

1.11 DATA PROTECTION AND DATA SECURITY

ASFINAG has in accordance with section 16a BStMG the right to process personal data with automatic help when it comes to toll collection, toll inspection and the prosecution of toll evasion. Furthermore, ASFINAG is also entitled to process personal data which is required for the vignette registry (see section 1) in accordance with section 16 BStMG.

To verify if the toll has been paid properly and to trace toll evasion, in accordance with section 19a BStMG, ASFINAG is entitled to use technical equipment. For the description of how the technical equipment is working see section 1.8.1 and 1.8.2. The picture data as well as the acquired license plate numbers and inspection data may be processed for the purpose of collecting the toll, substitute toll requests and to prosecute toll evasion.

Further explanations about data protection regulations as well as information about rights of the concerning person can be looked up on www.asfinag.at.

1.12 PLACE OF AND APPLICABLE LAW

The exclusive place of jurisdiction for all claims against ASFINAG under civil law arising out of these Tolling Regulations and/or the use of the toll road network shall be the court that has jurisdiction as regards such matters for the first district in Vienna. Only Austrian law applies, excluding the conflict of laws rules of private international law.

1.13 COMPETENCE AND CUSTOMER SERVICE

All queries or applications for refunds should be addressed to ASFINAG Maut Service GmbH:

ASFINAG Maut Service GmbH

Alpenstraße 99

A-5020 Salzburg

Austria

Tel.: 0800 400 12 400 (free of charge when calling from Austria or Germany)

Tel.: +43 (1) 95 51 266 (not free of charge when calling from all other countries)

Fax: +43 (1) 95 51 277

E-Mail: info@asfinag.at / <http://www.asfinag.at>

2 FURTHER REGULATIONS WHEN USING A TOLL STICKER

In addition to the general regulations the following regulations apply in case a toll sticker is used.

2.1 TOLL STICKER SALES OUTLETS

Toll stickers can be purchased at sales outlets marked with the toll sticker symbol (see appendix 1).

The price of purchased toll stickers cannot be refunded or replaced.

2.2 ATTACHING THE TOLL STICKER

2.2.1 Where and how to attach the toll sticker

Before using the toll road network, a valid toll sticker, which has to be appropriate to the respective vehicle category, must be properly attached to every vehicle that is liable for the toll using the original toll sticker adhesive strip (taking into account section 2.2.2 of Tolling Regulations Part A I). Any other method of attachment (e.g. using [additional] adhesive strips, any other method of fixation, or covering the toll sticker with an additional protective film) is not permissible, nullifies evidence that the toll has been properly paid, and can constitute a toll evasion offence (see section 1.9). Ten-day toll stickers and two-month toll stickers are only valid if they have been validated by correctly and completely punching holes in the appropriate calendar day and month.

Once it has been fully removed from the backing paper, the undamaged toll sticker for twin-track vehicles must immediately be attached to the inner surface of the windscreen so that it can easily be seen and monitored from outside the vehicle (e.g. the toll sticker should not be attached to the windscreen behind a strip of tinted glass). The non-observance of these toll sticker attachment provisions (e.g. if the toll sticker is not completely removed from the backing paper or if the toll sticker is not completely attached to the windscreen), can constitute a toll evasion offence (see section 1.9). It is not permissible to attach a toll sticker to a side window.

Drivers are advised to observe the recommendations on how to attach the toll sticker printed on the back of the toll sticker. On a motorcycle, toll stickers must be attached visibly and verifiable on a part of the motorcycle that is either difficult or impossible to remove.

In the interest of road safety and in order to ensure effective, user-friendly monitoring of time-related toll payment, a maximum of one other toll sticker should, if possible, be attached to the vehicle in addition to the valid toll sticker.

The removal and reattachment of an attached, valid toll sticker; the repeated use of the toll sticker, with the exception of the repeated use that is expressly permitted by these Tolling Regulations; or a chemical or technical manipulation of the original toll sticker adhesive strip in such a way that the toll sticker is prevented from self-destructing upon removal, is impermissible and can constitute a toll evasion offence.

2.2.2 Permissibility of carrying an unattached toll sticker in the vehicle

Drivers of approved vehicle models without windscreens are permitted to carry an unattached toll sticker in the vehicle. The same applies in cases where the manufacturer of a windscreen provides technical certification that toll stickers may not be attached to the windscreen on condition that an original vehicle-specific letter of authorisation by ASFINAG Maut Service GmbH (see section 1.13) is also carried in the vehicle.

In the case of vehicles that carry trade plates, drivers are permitted to carry an unattached, properly stamped two-month toll sticker in the vehicle instead of directly attaching the toll sticker to the vehicle (please refer to section 2).

Before leaving a parked vehicle (e.g. at service areas on the toll road network) the driver must ensure that the toll sticker is clearly visible and verifiable from outside the vehicle. Failure to comply with this provision constitutes a toll evasion offence (see section 1.9).

2.3 TOLL STICKER REPLACEMENT

In case the windscreen to which the annual toll sticker was attached is destroyed and replaced, ASFINAG Maut Service GmbH (see point 1.13) provides, as long as there are no claims against third parties, a replacement of the toll sticker free of charge. Should a replacement of the toll sticker be required, the following evidence must be provided:

- a copy of the vehicle registration document
- a copy of the invoice for the replaced wind screen issued by the garage that carried out the repairs (in the case of company cars, the name of the driver must also be given);
- the detached toll sticker together with the lower section (allonge) of the toll sticker;
- a toll sticker replacement form (filled out and signed).

If a vehicle to which an annual toll sticker is attached is damaged to such an extent as a result of an accident or force majeure that the vehicle is no longer roadworthy (i.e. the vehicle is a technical write-off), the owner of the annual toll sticker is entitled to apply for a free replacement toll sticker from ASFINAG Maut Service GmbH as long as there are no claims against third parties.

Should such a replacement toll sticker be required, the following evidence must be provided:

- the original removed annual toll sticker or a sufficient part of the remaining toll sticker including the lower section (toll sticker tab and/or backing paper);
- confirmation from a garage or automobile club that the vehicle is a technical write-off or confirmation that it has been scrapped or handed over to a third party for scrapping.
- confirmation from the vehicle registration unit that the vehicle has been removed from the register;
- brief description of the events that occurred.

In cases where the toll sticker has been rendered invalid or destroyed in circumstances that fall within the sphere of responsibility of the toll sticker producer, ASFINAG Maut Service GmbH (see information in section 1.13) or its authorized agents shall provide a replacement of the toll sticker free of charge.

In cases of doubt, ASFINAG is entitled to request photographic evidence of the vehicle in question.

If the applicant wishes to register his or her license plate number in the toll system (digital vignette) instead of a replacement of the toll sticker, he or she should request that on the toll sticker replacement form and attach the vehicle registration document .

More details and the toll sticker replacement form are available on the Internet at www.asfinag.at (please refer also to the information in section 1.13). It is impermissible for a driver to use toll roads until such time as the replacement toll sticker has been received.

No replacements are provided for toll stickers that are destroyed in other circumstances (e.g. the removal of a toll sticker that has already been attached).

3 FURTHER REGULATIONS WHEN USING A DIGITAL VIGNETTE

3.1 AVAILABILITY OF THE DIGITAL VIGNETTE

The time-related toll can also be paid by registering the vehicle's license plate number (digital vignette) in ASFINAG's vignette registry. The digital vignette is available on the day determined in the ordinance of the Federal Ministry for Traffic, Innovation and Technology about the vignette price regulation (Vignettenpreisverordnung 2017) at the latest. The first day of validity of a digital ten-day, two-month or annual vignette is 1st December 2017.

3.2 OBTAINING THE DIGITAL VIGNETTE

The following distribution channels are provided to register the vehicle's license plate (obtaining the digital vignette) in ASFINAG's toll system.

3.2.1 Obtaining the digital vignette in the webshop and with the ASFINAG app

The digital vignette can be obtained in the webshop or with the ASFINAG app within Austria, the European Union as well as in the EEA states and Switzerland.

3.2.1.1 Beginning of validity

If the digital vignette is obtained with the means of distance communication, that means in the webshop or by using the ASFINAG app, the first day of validity is basically the 18th day after purchase at the earliest.

Some examples:

On 15th January a digital vignette is purchased in the ASFINAG webshop. Therefore, the first day of validity is 2nd February at the earliest and one is permitted to use the motorways and expressways from that day onwards.

Another, later date for the first day of validity (in the example shown above, for example the 5th April) can be manually chosen in case of purchasing a digital ten-day or two-month vignette. It is only possible to choose dates for which the vignette prices are already set and implemented at the time of purchase (see section 1.4).

The permission to use the motorways and expressways will be granted from the first day of validity chosen, but from the 18th day after purchase at the earliest.

The duration of entitlement of use is regulated in section 1.5.

3.2.1.2 Required minimum details

To obtain a digital vignette in the webshop or with the ASFINAG app, the following information has to be provided:

- The vehicle's license plate number that shall be registered in the toll system as well as the state of registration of the particular vehicle
- Data relevant for the cashless purchase (e.g. data of the credit card, etc.)
- A valid e-mail address (for the purpose of sending an order confirmation, the receipt, as well as the terms of use)

The order confirmation must be reviewed of its data (particularly in regard to the vehicle's registered license plate number as well as the validity period of the digital vignette).

For later changes of the digital vignette in the webshop or via the ASFINAG app under "my account" (see section 3.6 and 3.2.4) the product-ID is needed, which serves also as an identification and is displayed on the order confirmation. Therefore, the order confirmation should be well kept for the time of validity of the digital vignette.

3.2.2 Purchase of the digital vignette at a vending machine

The digital vignette can also be purchased at vending machines They are freely accessible. Further information about the location of those vending machines is available on www.asfinag.at.

3.2.2.1 Beginning of validity

If the digital vignette is purchased at a vending machine, it is immediately valid and the permission to use the motorways and expressways is granted right away.

Another, later date for the first day of validity can be manually chosen when a two-month or ten-day vignette is bought. It is only possible to choose from dates if the vignette prices are already set and implemented at the time of purchase (see section 1.4).

The permission to use the motorways and expressways is only granted from the first day of validity onwards.

The duration of entitlement of use is regulated in section 1.5.

3.2.2.2 Required minimum details

To purchase a digital vignette at a vending machine the license plate number, which should be registered in the toll system of ASFINAG, as well as the state of registration of the particular license plate, have to be provided.

A confirmation about the registration of the license plate number in the toll system of ASFINAG (order confirmation) as well as the receipt will be printed at the vending machine. The order confirmation must be reviewed of its data (especially in regard to the license plate number that needs to be registered as well as the validity period of the digital vignette).

For later changes of the digital vignette in the webshop or via the ASFINAG app under “my account” (see section 3.6 and 3.2.4) the product-ID is required, which also serves as identification and is displayed on the order confirmation. Therefore, the order confirmation should be well kept for the time of validity of the digital vignette.

3.2.3 Means of payment

The digital vignette has to be paid exclusively in EURO. Further information on which methods of payment or means of payment are accepted, is available in appendix 2, on www.asfinag.at respectively at the customer service (see the information in section 1.13).

3.2.4 Additional services

Customers can always create a personal user account (“my account”) by entering the login data in the webshop and/or ASFINAG app, also after finishing the purchasing process.

The following services are provided after creating a personal user account and logging in to the webshop respectively the ASFINAG app:

- administration of personal data
- administration of vehicles' license plate numbers

- allocation of digital vignettes that have already been obtained to the personal user account according to the product-ID
- administration of digital vignettes that have already been obtained
- reprints of receipts

3.2.5 Terms of use

Further information on the purchase of the digital vignette in the webshop and via the ASFINAG app, the required details and steps as well as the additional services, are available in the terms of use, which can be retrieved on www.asfinag.at.

3.3 RIGHT OF WITHDRAWAL

If the digital vignette has been purchased by means of distance communication (webshop or ASFINAG app), the customer can withdraw from the purchase without stating any particular reason, within 14 calendar days from the day on which the digital vignette has been bought.

In order to make use of the right of withdrawal, ASFINAG needs to be informed about the decision to withdraw from the purchase by a clear statement. The withdrawal period is maintained if the statement of withdrawal is sent within the given period.

Further information on the statement of withdrawal as well as the reimbursement of payments made in advance are available on www.asfinag.at.

3.4 SPECIFICS FOR ENTREPRENEURS CONCERNING THE PURCHASE OF A DIGITAL VIGNETTE

If an entrepreneur purchases a digital vignette within his work as an entrepreneur, the following regulations apply:

An entrepreneur needs to confirm his or her entrepreneurial status as well as the purchase of the digital vignette in the webshop or with the ASFINAG app within his work as an entrepreneur. In this case there is no right of withdrawal and the day of purchase of the digital vignette can be chosen as the first day of validity.

In addition to the minimum details for the purchase of the digital vignette mentioned in section 3.2.1.2, the invoice recipient's details can respectively must be provided if the amount succeeds EUR 400,- (gross).

3.5 POSSIBLE CHANGES BEFORE THE BEGINNING OF VALIDITY

If the validity of a digital vignette has not started yet, the vehicle's license plate number and the state of registration registered in the toll system can be changed. Moreover, in case of two-month and ten-day vignettes the first day of validity can only be changed under the following conditions:

- If the digital vignette has been obtained in the webshop or with the ASFINAG app, the first day of validity cannot be before the 18th day, 0 o'clock after the day of purchase.

For example: A ten-day digital vignette has been purchased in the webshop on 15th January. Therefore the validity starts on 2nd February, 0 o'clock at the earliest.

- The first day of validity cannot be set – at the time of change – to a day in the past.

For example: A ten-day digital vignette has been purchased with its validity starting on the 1st April. If the first day of validity is changed on 25th March, note that the start of validity cannot be set to 24th March or earlier (that means into the past).

- Basically, the beginning of validity can be changed to the day on which the change is made, whereby the permission to use the toll road network only begins at the time of change.

For example: If today at 14:07 the beginning of validity of a digital vignette is changed to today, the toll road network can be used only from 14:07. The use of the toll road network before that time, referring to that vignette, is prohibited and constitutes the offense of toll evasion.

- The first day of validity can only be changed from 1st December of the current year to 30th November of the following calendar year (for details see sections 1.5.2 and 1.5.3).

For example:

Possible: Postponement from 1st April to 1st October of the same calendar year.

Not possible: Postponement from 1st October to 10th December of the same or from the 1st of October to the 1st of February of the following calendar year. It is also impossible to prepone the date from 10th December to 15th November of the same calendar year.

If the digital vignette has already been purchased, the following changes cannot be made:

- Changes of the validity duration, that means
 - a ten-day vignette cannot be changed to a two-month or annual vignette;
 - a two-month vignette cannot be changed to a ten-day or annual vignette;
 - an annual vignette cannot be changed to a ten-day or two-month vignette.
- Change of a digital vignette for a single-track vehicle to one for a two-track vehicle and vice versa.
- Change from a digital vignette to a toll sticker

The at the beginning defined and allowed changes can be made by meeting the following requirements:

- In the webshop and with the ASFINAG app (after the registration and login) in the personal user account (see section 3.2.4)

- At the customer service center by providing the order confirmation or product-ID, a copy of the vehicle's registration document of the currently registered license plate number, as well as the registration document of the vehicle that should be registered instead (in case the license plate number is going to be changed).

In cases of doubt ASFINAG has the right to demand further documents of proof.

3.6 POSSIBLE CHANGES AFTER THE BEGINNING OF VALIDITY

After the beginning of validity only digital annual vignettes can be changed.

Thereby, a change of the vehicle's registered license plate number to a newly assigned license plate number of the same vehicle owner can only be requested in the following cases:

- The vehicle owner changes his or her place of residence and receives, due to the therefore necessary new vehicle registration, a newly assigned license plate number (this is the case, for example, when somebody changes his or her place of residence to another administrative district).
- The vehicle owner receives a newly assigned license plate number due to theft of his/her vehicle.
- The vehicle owner receives a newly assigned license plate number due to theft of the previous license plate.
- The vehicle owner receives a newly assigned license plate number for his/her newly registered vehicle as his/her vehicle has been damaged due to an accident or force majeure which has made the usage of the road network impossible (total loss).
- In "similar cases" to the above mentioned in accordance with section 11(5) BStMG.

The next usage of the road toll network is only permitted if the change has been completed in the toll system. After the change of the digital annual vignette, the authorization to use the motorways and expressways with the old license plate number expires.

For a successful change, documents of proof need to be provided. These changes can be effected in the personal user account of the webshop (after registration and login) or at the ASFINAG service center.

In this regard, the following documents of proof have to be uploaded in the webshop or submitted to the ASFINAG service center:

- documents which prove that the requirements for a change after the beginning of validity of a digital annual vignette are met (e.g. proof of residence, proof of total loss, theft report)
- copy of the registration document of the particular vehicle's license plate number that has been registered in the toll system, as well as the copy of the new vehicle's registration document for the license plate that should be registered instead
- provision of the order confirmation respectively the product-ID (in case the change is requested at the ASFINAG service center)

In cases of doubt ASFINAG has the right to demand further documents of proof.

3.6.1 Conditional changes in the ASFINAG webshop

If any changes of the digital vignette is requested in the ASFINAG webshop, the following steps are required:

- make an application for a conditional change
- upload appropriate documents of proof as *.pdf, *.jpg or *.tif
- make the payment of EUR 18.00 incl. VAT (in the cases mentioned below the amount will be refunded). Regarding the possible means and methods of payment see appendix 2.

The requested change in the webshop is (provisionally) immediately effective and permits the driver for the time of ten calendar days (whereby the day on which the request has been made is not counted) to use the toll road network. Therefore, for this certain time period the digital vignette belonging to the previous license plate number expires.

During these ten calendar days ASFINAG will verify the uploaded documents of proof. In certain cases (e.g. change of residence within Austria), the verifying process can be automatically supported.

ASFINAG will try to inform the applicant about the proof status by the applicant's given e-mail address. Apart from that, there is the possibility to query the vignette registry at any time whether there is a valid digital vignette for the respective license plate number.

After a positive verification process the digital vignette will be permanently changed to the newly assigned license plate number.

Furthermore, the amount of EUR 18.00 incl. VAT will be refunded in the following cases:

- a newly assigned license plate number due to theft of vehicle
- a newly assigned license plate number due to theft of the (originally registered) license plate number
- a newly assigned license plate number due to total loss

In the case of a change due to a newly assigned license plate number as a result of change of residence as well as in similar cases the amount of EUR 18.00 incl. VAT will be considered as a reimbursement of expenses and therefore not be refunded.

If the verification process is concluded with a negative outcome, the (provisional) change will be reversed by the end of the 10th calendar day and the digital vignette that has been bought for the previous license plate number comes into effect again. The paid amount of EUR 18.00 incl. VAT will be considered as a reimbursement of expenses and therefore not be refunded.

3.6.2 Changes at the ASFINAG service center

Changes in regard to the digital vignette can also be requested at the ASFINAG service center (see section 1.13) in the following cases:

- a newly assigned license plate number due to theft of vehicle
- a newly assigned license plate number due to theft of the (originally registered) license plate number
- a newly assigned license plate number due to total loss

In this regard certain documents have to be submitted in order to grant the changes, whereby documents of proof are accepted in the following form: *.pdf, *.jpg or *.tif.

The requested changes only come into effect after the ASFINAG service center has finished the verification process with a positive result.

In case of a newly assigned license plate number due to change of residence respectively in similar cases, changes can only be made in the webshop (see point 3.6.1) after paying the reimbursement of expense.

ASFINAG will inform about the result of the verification process. Apart from that, there is the possibility to query the vignette registry at any time whether there is a valid digital vignette for the respective license plate number.

After a positive verification process the digital vignette will be permanently changed to the newly assigned license plate number and permits the driver to use the road toll network. The digital vignette for the previous license plate number expires at that time.

PART A II: TOLLING REGULATIONS FOR VEHICLES WITH A MAXIMUM GROSS VEHICLE WEIGHT OF UP TO 3.5 t FOR EXISTING TOLL ROAD SECTIONS ON THE AUSTRIAN MOTORWAY AND EXPRESSWAY NETWORK: A 9, A 10, A 11, A 13, S 16

1. GENERAL REGULATIONS

1.1. DEFINITION OF TERMS

- **digital section toll:** The section toll paid in advance by registering the vehicle's license plate number in the toll system.
- **order confirmation:** The document issued when a digital vignette has been obtained (registration in the toll system). This document particularly shows data of the license plate number registered in the toll system, vehicle type, validity period as well as the product-ID, which serves to clearly identify the digital vignette.
- **allonge:** The lower section of the toll sticker (backing paper/ toll sticker tab).
- **ASFINAG app:** If in the following the term ASFINAG app is being used, the ASFINAG app „Unterwegs“ is meant.
- **vignette registry:** This term is used to define the publicly accessible registry on www.asfinag.at, which can be visited by any person without any costs, to view whether a license plate number is already registered in the toll system and therefore owns a digital vignette or a digital section toll ticket and for what time period it is valid.
- **type of vehicle:** Hereby a differentiation between single-track vehicles and twin-track vehicles with a maximum gross vehicle weight of up to 3.5 tonnes is made.

1.2. SCOPE OF APPLICATION

Tolling Regulations Part A II applies to all vehicles with a maximum gross vehicle weight of up to 3.5 t (in short "category 1"). Unless expressly indicated otherwise, all references to individual sections contained in Part A II of the Tolling Regulations relate to sections in Part A II of the Tolling Regulations.

Twin-track vehicles that have not yet been registered and carry trade plates are obliged to pay the rates in category 1 in accordance with section 1.4, as long as their service weight does not exceed 3.5 t. Drivers must carry a copy of the vehicle's logbook when driving in a vehicle carrying trade plates. The driver must show this document to toll enforcement officers or toll collection employees if requested to do so.

No toll must be paid for trailers being towed by twin-track vehicles with a maximum gross vehicle weight of up to 3.5 t.

1.3. ROAD SECTIONS ON WHICH TOLLS ARE LEVIED

1.3.1. Names of the section toll segments and toll points

The table below lists the names of the toll road sections respectively section toll segments, and toll points that are the subject matter of and are subject to Tolling Regulations Part A II:

| Motorway | Name of the toll road section / section toll segment | Name of the toll point |
|--|--|-----------------------------|
| The sections of the A 9 Pyhrn motorway between the Spital/Pyhrn and Arding junctions and between the St. Michael intersection and the Übelbach junction | Bosruck/Gleinalm | Bosruck toll point |
| | | Gleinalm toll point |
| The section of the A 10 Tauern motorway between the Flachau and Rennweg junctions | Tauern/Katschberg | St. Michael i.L. toll point |
| The section of the A 11 Karawanken motorway between the St. Jakob im Rosental junction and the international border in the Karawanken tunnel; | Karawanken | Rosenbach toll point |
| A 13 Brenner motorway | Brenner | Schönberg main toll point |
| The section of the S 16 Arlberg expressway between the St. Anton am Arlberg and Langen am Arlberg junctions | Arlberg | St. Jakob toll point |



Illustration 9

1.3.2. Signing

Drivers are notified of the mandatory toll by appropriate mandatory signs at the start of each toll road section.

1.4. PLACE OF JURISDICTION AND APPLICABLE LAW

The exclusive place of jurisdiction for all claims against ASFINAG under civil law arising out of these Tolling Regulations and/or the use of the toll road network shall be the court that has jurisdiction as regards such matters for the first district in Vienna. Only Austrian law applies, excluding the conflict of laws rules of private international law.

1.5. COMPETENCE AND CUSTOMER SERVICE

All queries or applications for refunds should be addressed to ASFINAG Maut Service GmbH:

ASFINAG Maut Service GmbH

Alpenstraße 99

A-5020 Salzburg

Austria

Tel.: 0800 400 12 400 (free of charge when calling from Austria or Germany)

Tel.: +43 (1) 95 51 266 (not free of charge when calling from all other countries)

Fax: +43 (1) 95 51 277

E-Mail: info@asfinag.at / <http://www.asfinag.at>

2. OBLIGATION TO PAY THE SECTION TOLL

Vehicles may only drive through existing toll points on the specially marked lanes. Depending on traffic volume, so-called open toll lane operation or mixed toll lane operation may be used on these lanes.

2.1. MIXED TOLL LANE OPERATION

During mixed lane operation (see illustration 9a), the toll lane may be used by both vehicles with a maximum gross vehicle weight of up to 3.5 t and vehicles with a maximum gross vehicle weight of more than 3.5 t (see Tolling Regulations Part B). Instructions given by the toll point personnel must be followed. There are no special toll lane operation signs at the secondary toll points at the Zederhaus and St. Michael/Lungau junctions on the A 10 and the Zenzenhof, Igls Patsch, Schönberg Stubaital, Matrei Steinach, Nösslach, and Brennersee junctions on the A 13.

2.2. OPEN TOLL LANE OPERATION

During open toll lane operation, one lane is reserved for vehicles that are liable for the distance-related toll. These lanes will be clearly marked as such (see illustration 9b).

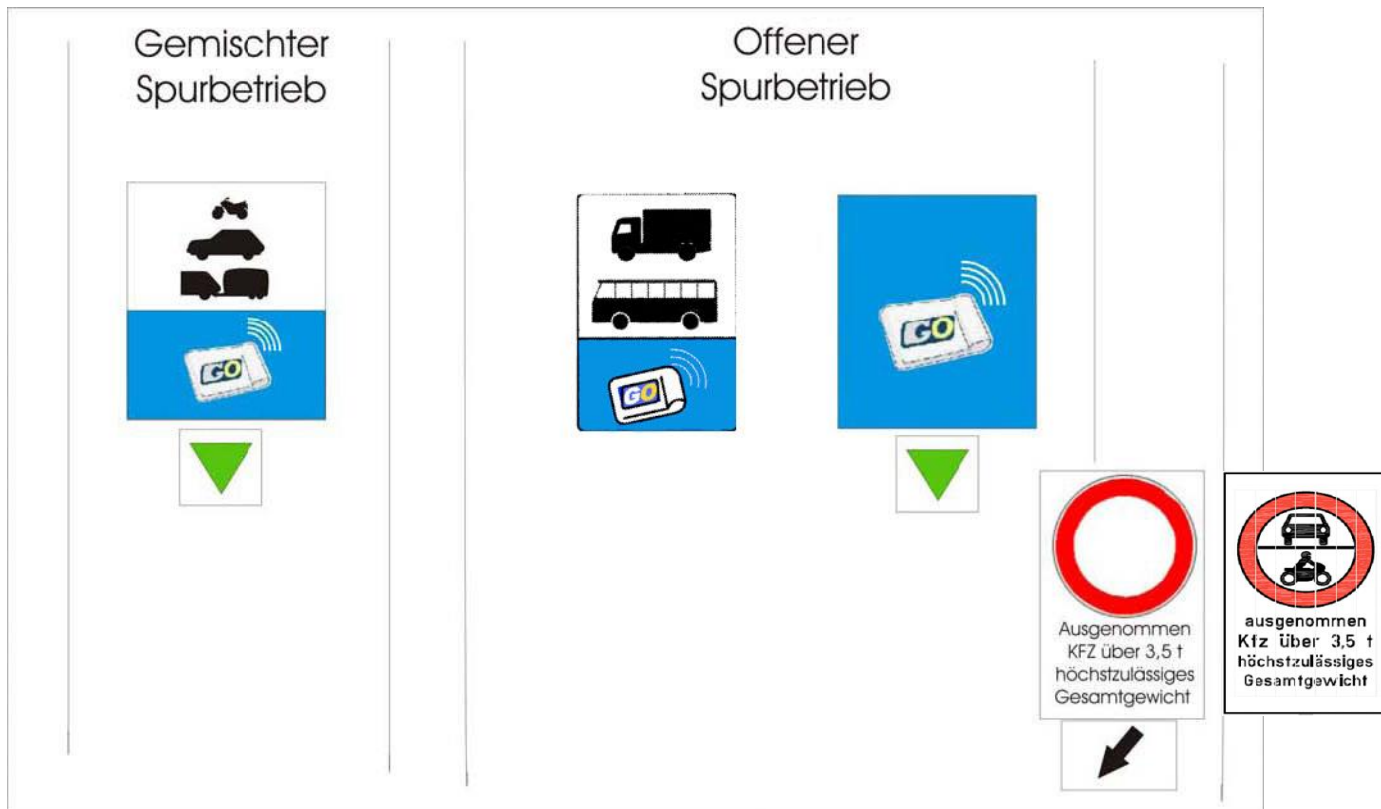

Illustration 9a: 'mixed lane operation'

Illustration 9b: 'open lane operation'

In this open lane operation, this lane is prohibited for vehicles with a maximum gross vehicle weight of up to 3.5 t (category 1) by a driving ban according to the Road Traffic Act (StVO). Category 1 vehicles are not permitted to use this lane. Drivers who violate this prohibition are in breach of an administrative rule (see section 7).

2.3. EXEMPTIONS FROM THE MANDATORY TOLL

2.3.1. Permanent exemptions

The following vehicles are exempt from the road section toll:

- Vehicles with flashing blue light in accordance with section 2(1)(25) StVO 1960, BGBl. No. 159 (operational vehicles) for the time one of these signals is used, whereby ASFINAG is authorized to randomly check the correctness of the declaration that the vehicle has been operationally used by contacting the appropriate command and control centre afterwards. The exemption of the mandatory toll is also valid for the return journey in case the signals have been used.
- Army vehicles (section 2(1)(38) Motor Traffic Act 1967).
- Vehicles that are used within the scope of the agreement among the states party to the North Atlantic Treaty and the other states participating in the Partnership for Peace regarding the status of their forces ('PfP-SOFA').
- Vehicles that are used for the implementation of measures for securing peace within the scope of an international organisation, the Organisation for Security and Co-operation in

Europe, or the European Union in conformity with a Decision made within the scope of the Common Foreign and Security Policy.

Vehicles that have blue headlights or warning lights visibly attached to the exterior, but are not registered and carry therefore trade plates or other equivalent plates and that use the toll road network are not exempt from the mandatory toll.

2.3.2. Temporary exemptions

In addition to the above provision, ASFINAG may in accordance with section 5(2) BStMG and depending on the circumstances, exempt vehicles with a maximum gross vehicle weight of up to 3.5 t that are delivering humanitarian aid in the event of emergencies or disasters from paying the mandatory toll.

To obtain such an exemption, which allows a trip to be completed without payment of the road section toll at a toll point, an exemption application form in accordance with appendix 3c (which can be downloaded at www.asfinag.at) must be completed, properly signed, and returned to ASFINAG either by e-mail to info@asfinag.at or by fax to +43 1 955 12 77 at least 24 hours before use of the toll road network. The applicant will receive confirmation.

The fully completed and signed application form (original) containing the issued application number must be handed over at the relevant toll point. If a return journey is to be made, a copy of the original application form must be made and handed over at the toll point on the return journey.

This provision applies exclusively to those cases that result from a cause within the meaning of section 5(2) of the BStMG and is announced at this point in the Toll Regulations.

3. TOLL RATES

Each toll rate includes 20 % VAT and is explained in the tables below.

Amendments to the toll rates during the period of validity of the various pre-paid toll cards do not have any bearing on the toll rate already paid. Such amendments shall not, therefore, result in any claims from whatever party regarding additional payment or refund of the toll difference.

3.1 Standard toll rates

The following toll rates apply to the section toll segments:

3.1.1 A 9 Gleinalm and A 9 Bosruck

| Category 1 | Card type | Price | Gleinalm | Bosruck |
|-------------------------------------|----------------------------|----------|----------|---------|
| A 9 Gleinalm Bosruck | Single trip | | € 8.50 | € 5.00 |
| | Annual card | € 102.50 | | |
| | AC Commuter ⁽¹⁾ | | € 40.50 | € 40.50 |

(1) see section 3.2.44

3.1.2 A 10 Tauern/Katschberg

| Category 1 | Card type | Price | Total toll road section | Toll road subsection |
|--|----------------------------|----------|-------------------------|----------------------|
| A 10 Tauern/ Katschberg | Single trip | | € 11.50 | € 5.50 |
| | Annual card | € 107.50 | | |
| | AC commuter ⁽¹⁾ | € 40.50 | | |

(1) see section 3.2.44

3.1.3 A 11 Karawanken

| Category 1 | Card type | Price | Price per trip |
|----------------------------|-------------------------------------|---------|----------------|
| A 11 Karawanken | Single trip | | € 7.20 |
| | 14-trip monthly card ⁽¹⁾ | € 32,20 | € 2,30 |

(1) see section 3.2.92.9

3.1.4 A 13 Brenner

| Category 1 | Card type | Price | Total toll road section | Toll road subsection 1 | Toll road subsection 2 | Toll road subsection 3 | Toll road subsection 4 |
|-------------------------|-----------------------------|----------|-------------------------|------------------------|------------------------|------------------------|------------------------|
| A 13 Brenner | Single trip | | € 9.00 | € 1.00 | € 2.50 | € 3.00 | € 4.50 |
| | Annual card | € 102.50 | | | | | |
| | AC commuter ⁽¹⁾ | € 40.50 | | | | | |
| | Monthly card ⁽²⁾ | € 40.50 | | | | | |

(1) see section 3.2.44

(2) see section 3.2.7.7

Total toll road section: every trip past the main toll point

Toll road subsection 1: Innsbruck–Zenzenhof or Brenner Pass–Brennersee and respectively in the other direction

Toll road subsection 2: Innsbruck–Patsch/Europabrücke or Brenner Pass–Nösslach and respectively in the other direction

Toll road subsection 3: Innsbruck–Stubaital and in the other direction

Toll road subsection 4: Matri–Brenner Pass and in the other direction

3.1.5 S 16 Arlberg road tunnel

| Category 1 | Card type | Price | Price per trip |
|------------------------------------|----------------------------|----------|----------------|
| S 16 Arlberg Tunnel | Single trip | | € 9.50 |
| | Annual card | € 102.50 | |
| | AC commuter ⁽¹⁾ | € 40.50 | |

(1) see section 3.2.44

3.2 TYPE OF RATES

The options to pay the toll are explained in section 4.

3.2.1 Single trip

A single trip ticket is valid for one year from the date of issue and permits to use a particular toll road section for one direction.

3.2.2 Annual card (without vignette credit)

The annual card is tied to the vehicle's license plate number and has a validity period of one year, whereby the first day of validity can be chosen freely during the purchasing process. The last possible first day of validity of the current calendar year is 31st December. An annual card entitles the user to an unrestricted use of a particular section toll segment. There is no annual card available for the A 11 Karawanken motorway.

3.2.3 Annual card with vignette credit

In accordance with section 13(3)(2) BStMG, the presentation of the allonge (toll sticker tab) or the product-ID of a valid annual vignette for the same passenger car's or motorcycle's vehicle registration number entitles the holder to a once-off credit of € 40.00 (including 20 % VAT) against the purchase price of an annual card for one particular section toll segment.

3.2.4 Annual card for commuters

The annual card for commuters is valid for one year from the date of issue. For all toll roads, with the exception of the A 11 Karawanken motorway, annual cards for commuters can be obtained if the following conditions are fulfilled:

- The applicant is employed (also applies to conscripts).
- Verifiable and plausible confirmation of the place of residence and place of work are provided. Use of the toll road must either be unavoidable or at least constitute the shortest distance.
- The annual card for commuters is only issued for one vehicle registered in the commuter's name.

In accordance with section 13(3)(1) BStMG, the presentation of the allonge (toll sticker tab) or the product-ID of a valid annual vignette for the same license plate number entitles the holder to a free annual card for commuters. For each subsection of the toll road section A 9 Bosruck/Gleinalm the aforementioned requirements will be checked individually.

3.2.5 Annual card for disabled drivers

The annual card for disabled drivers is valid for one year from the date of issue and can be obtained for € 7.00 (including 20 % VAT) if the following conditions are fulfilled:

- Presentation of a disabled person's parking permit (according to §29b StVO)
- An entry in the valid driver's license indicating that the holder is restricted to driving disability-adapted vehicles - the entry that he or she is restricted to driving vehicles with automatic transmission is the minimum requirement.
- The annual card for disabled drivers is only issued for one vehicle registered in the disabled driver's name.

The card is also issued in the name of the beneficiary and is, in derogation of the general regulations for annual cards, valid for all ASFINAG section toll segments (Tolling Regulations Part A II), with the exception of A 11 Karawanken motorway.

3.2.6 Annual card for disabled drivers on the A 13

An annual card for disabled drivers on the A 13 is valid for one year from the date of issue and can be obtained for € 40.50 (including 20 % VAT) if the following conditions are fulfilled.

This card can be obtained by:

- holders of official certificates and victim's identity cards whose reduction in earning capacity is at least 50 per cent
- seriously disabled people according to section 9(2) of the War Victims Welfare Act
- blind civilians in possession of a blind person's identity card;
- disabled people who can provide evidence that they suffer from at least 50 per cent disability. The annual card for disabled drivers is only issued for a vehicle registered in the name of a disabled driver.

This annual card is valid for the A 13 Brenner motorway only.

By presenting the allonge (toll sticker tab) or the product-ID of a valid annual vignette for the same license plate number the annual card for disabled drivers is free of cost.

3.2.7 Monthly card for the A 13

This monthly card is restricted to one particular vehicle registration number and entitles the driver to an unlimited number of trips on the A 13 Brenner motorway within 30 calendar days from the date of issue. The card, which can be obtained for € 40.50 (incl. 20% VAT), is issued upon presentation of the vehicle's registration document.

3.2.8 Resident's card for the A 13

Inhabitants of the municipalities of Ellbögen, Gries am Brenner, Gschnitz, Matri am Brenner, Mühlbachl, Navis, Obernberg am Brenner, Patsch, Pfons, Schmirn, Steinach am Brenner, Trins, and Vals in the Wipp Valley (Wipptal) and the municipalities of Schönberg, Mieders, Fulpmes, Telfes, and Neustift in the Stubai Valley (Stubaital) will receive resident's cards as long as they meet the conditions listed directly below:

- The registered owner is a natural person.
- A valid confirmation of the applicant's main place of residence is provided.
- The resident's card is only issued for a vehicle registered in the applicant's name.
- The vehicle is registered in the name of a private person only and is not used as a company vehicle.

The resident's card for the A 13 is valid for one year from the date of issue and can be purchased for the price of EUR 40.50 (incl. 20% VAT) if the requirements are fulfilled. By presenting the allonge (toll sticker tab) or the product-ID of a valid annual vignette for the same license plate number the resident's card is free of cost.

3.2.9 14-trip monthly card for the A 11

This card is restricted to one particular vehicle registration number and entitles the driver to fourteen trips through the Karawanken tunnel during the 30 calendar days from the date of issue. Unused trip credits cannot be refunded at the end of the 30 calendar days.

3.3 LOSS OF LICENSE PLATE NUMBER RELATED CARDS

In the event of loss of a license plate number related card, a new card can be issued for EUR 7.00 (incl. VAT) at the toll point as reimbursement of expenses.

4. PAYMENT METHODS

4.1. PAYMENT AT THE TOLL POINT

The toll must be paid in euros at the toll points. Information regarding other acceptable means and methods of payment is given in appendix 2 and on the Internet at www.asfinag.at. This information may also be obtained from customer services (see information in section 1.5).

4.2. PURCHASE IN ADVANCE

4.2.1. Purchase in the webshop and with the ASFINAG app

Single-trip tickets (section 3.2.1), annual cards (section 3.2.2) as well as annual cards with vignette credit (section 3.2.3) are also offered in the webshop and in the ASFINAG app.

The purchase is possible in the webshop or by using the ASFINAG app within Austria, the European Union as well as in the EEA states and Switzerland.

In regard to the beginning of validity and the required minimum details, the regulations mentioned in Part A I, section 3.2.1.1 and 3.2.1.2 are in corresponding effect.

When purchasing single-trip tickets immediate validity can be demanded. Further information is available in the terms of use on www.asfinag.at.

4.2.2. Purchase at the vending machine

The range of products is limited at the vending machines. They are freely accessible. Further information on their location and the range of products is available on www.asfinag.at.

In regard to the beginning of validity and the required minimum details, the regulations mentioned in Part A I, section 3.2.2.1 and 3.2.2.2 are in corresponding effect.

4.2.3. Purchase at sales points

Single-trip tickets, annual cards (section 3.2.2) as well as annual cards with vignette credit (section 3.2.3) can be purchased at certain sales points. Further information is available in the terms of use on www.asfinag.at.

In regard to the beginning of validity and the required minimum details, the regulations mentioned in Part A I, section 3.2.2.1 and 3.2.2.2 are in corresponding effect.

4.2.4. Means of payment

The payment in the webshop, with the ASFINAG app and at vending machines must be made in euros. Information on which methods of payment respectively means of payment, , are accepted in the webshop, the ASFINAG app and at the vending machines is available in appendix 2 as well as on www.asfinag.at respectively at the customer service (see information in section 1.5). The accepted means of payment at the sales points can differ, depending on the sales point.

4.3. ADDITIONAL SERVICES (“my account”)

Customers can always (also after the end of the purchasing process) create a personal user account (“my account”) by entering the login data in the webshop as well as in the ASFINAG app. The regulations of Part A I, section 3.2.4. are in corresponding effect.

4.4. TERMS OF USE

Further information in regard to purchasing the digital section toll in the webshop and with the ASFINAG app, the required details and steps as well as the additional services, are available in the terms of use, which can be retrieved on www.asfinag.at.

4.5. RIGHT OF WITHDRAWAL

If the digital section toll has been paid for by means of distance communication, (in the webshop or with the ASFINAG app) the customer can withdraw from purchase without any particular reasons given, within 14 days from the day on which the digital section toll has been paid for.

To use the right of withdrawal, ASFINAG needs to be informed about the decision to withdraw from purchase by a clear statement. The withdrawal period is maintained if the statement of withdrawal is sent within the given period.

If, in case of single-trips, the single-trip ticket has been used (passing through the toll point), there is no right of withdrawal.

Further information about the statement of withdrawal as well as the reimbursement of payments made, can be found online in the terms of use on www.asfinag.at.

4.6. SPECIFICS FOR ENTREPRENEURS

The regulations in Part A I, section 3.4. correspondingly apply to entrepreneurs who purchase the digital section toll within their work as entrepreneurs.

4.7. POSSIBLE CHANGES

When it comes to single-trips, the license plate number and state of registration registered in the toll system can be changed before using the section toll segment.

In the case of an annual card, the license plate number and state of registration can be changed, if the validity has not started yet. Furthermore, the first day of validity can also be changed, whereby the following must be taken into account:

- If the annual card has been purchased in the webshop or with the app, the first day of validity cannot be before the 18th day, 0 o'clock, after the purchase.

For example: The annual card has been purchased in the webshop on 15th January. Therefore, the beginning of validity is in any case the 2nd February, 0 o'clock at the earliest.

- At the time of change, the first day of validity cannot be set to a day in the past.

For example: An annual card, with its validity starting on the 1st April, has been purchased. If the first day of validity is being changed on 25th March, note that the new beginning of validity cannot be set to 24th March or earlier (which means into the past).

- Basically, the beginning of validity can be changed to the day on which the change is being made, whereby the permission to use the section toll segment only begins at the time of change.

For example: If today at 14:07 the beginning of validity of an annual card is changed to today, the permission to use the section toll segment starts at 14:07. The use of the section toll segment before that time referring to that annual card is prohibited and can constitute a toll evasion offence.

- The first day of validity can only be changed within the calendar year.

For example:

Possible: Postponement from 1st April to 1st October of the same year.

Not possible: Postponement from the 1st October of the current to 1st February of the following calendar year. It is also impossible to prepone the date from 1st February to 1st October of the previous calendar year.

The at the beginning defined and allowed changes can be made by meeting the following requirements:

- In the webshop and with the ASFINAG app (after the registration and login) in the personal user account (see section 4.3)

- At the customer service center by providing the order confirmation respectively product-ID, a copy of the registration document of the particular vehicle's license plate number that is currently registered in the toll system, as well as a copy of the new vehicle's registration document for the license plate that should be registered instead, when changing the vehicle's license plate number
- At the toll point by providing the order confirmation respectively product-ID, a copy of the registration document of the particular vehicle's license plate number that is currently registered in the toll system, as well as a copy of the new vehicle's registration document for the license plate that should be registered instead, when changing the vehicle's license plate number.

In cases of doubt ASFINAG is entitled to demand further documents of proof.

4.8. CHANGES AFTER THE BEGINNING OF VALIDITY

If the validity of an annual card has already started, a change of the vehicle's license plate number, which is already registered in the toll system, to a new license plate number of the same vehicle owner, can only be requested in the following cases:

- The vehicle owner changes his or her place of residence and receives, due to the therefore necessary new vehicle registration, a newly assigned license plate number. (This is the case, for example, when somebody changes his or her residence to another administrative district).
- The vehicle owner receives a newly assigned license plate number due to the theft of his/her vehicle ,
- The vehicle owner receives a newly assigned license plate number due to the theft of the previous license plate.
- The vehicle owner receives a newly assigned license plate number for his/her newly registered vehicle as his/her vehicle has been damaged due to an accident or force majeure, which has made the usage of the road network impossible (total loss).
- In "similar cases" to the above mentioned in accordance with section 11(5) BStMG

The next usage of the section toll segment is only permitted if the registration of the newly assigned license plate number has been completed in the toll system. After the changes of the annual card, the authorization to use the section toll segment with the originally registered license plate number expires.

The regulations mentioned in Part A I, section 3.6 on providing documents of proof, on conditional changes in the ASFINAG webshop as well as the changes requested at the ASFINAG service center are correspondingly valid.

Customers should notice that with the application for changes of the annual card in the webshop, an amount of EUR 18,00 incl. VAT needs to be paid. This amount will be refunded in cases like those stated in Part A I, section 3.6.1 after a positive verification process. In the event of a newly assigned license plate number due to a change of place of residence, as well as similar cases and in case the verification process is concluded with a negative outcome, the amount of EUR 18.00 incl. VAT will be kept as a reimbursement of expenses and therefore not be refunded.

5. DATA PROTECTION AND DATA SECURITY

ASFINAG has in accordance with section 16a BStMG the right to process personal data with automatic help when it comes to toll collection, toll inspection and the prosecution of toll evasion. Furthermore, ASFINAG is also entitled to process personal data which is required for the vignette registry (see section 1) in accordance with section 16 BStMG.

To verify if the toll has been paid properly and to trace toll evasion, in accordance with section 19a BStMG, ASFINAG is entitled to use technical equipment. For the description of how the technical equipment is working see point 1.8.1 and 1.8.2. The picture data as well as the acquired license plate numbers and inspection data may be processed for the purpose of collecting the toll, substitute toll requests and to prosecute toll evasion.

Further explanations about data protection regulations as well as information about rights of the concerning person can be looked up on www.asfinag.at.

6. MONITORING THE PROPERLY PAID SECTION TOLL

6.1. TOLL ENFORCEMENT OFFICERS

Toll enforcement officers are public inspection officers. They are nominated by ASFINAG and are appointed and sworn in to the job by the local district administrative authorities.



Illustration 10

When discharging their duties, toll enforcement officers must carry with them the identification card defined below and show it to the person concerned when requested to do so. The identification card for toll enforcement officers, which confirms their official status, is the size of a cheque card, is printed on both sides, and features the following in particular: a photograph and the name, and duty number of the toll enforcement officer (see illustration 11).



Illustration 11

The toll enforcement officers' vehicles are public security force enforcement vehicles that comply with section 20(1)(4) lit.a of the Motor Vehicle Act 1967. These vehicles are silver-grey operational vehicles that are equipped with flashing blue lights and a siren. Furthermore, they are marked with the following words: 'ASFINAG', 'Mautaufsicht' (toll enforcement) and 'Service- und Kontrolldienst der ASFINAG' (ASFINAG customer service and toll enforcement unit). See illustration 12 for details.



Illustration 12

In order to monitor the correct payment of tolls, toll enforcement officers are authorized, among other things, to use clearly visible and audible signals to request drivers to stop; to stop these drivers; to determine the identity of the driver and the registered owner; to inspect the vehicle (in particular the vehicle registration documents), to inspect evidence of the service weight of a vehicle carrying trade plates in accordance with section 1.2 (in particular a copy of the vehicle's logbook); and to verbally request the apprehended driver to pay the substitute toll.

Moreover, in order to monitor the correct payment of tolls and to conduct traffic surveys, toll enforcement officers are authorized to use automatic traffic diversion equipment to divert traffic to toll inspection areas. Additionally, toll enforcement officers may also monitor the correct payment of tolls and conduct traffic surveys at border crossings and junctions.

If no substitute toll is paid and if prosecution or execution of a sentence appear obviously impossible or very difficult, the toll enforcement officers are authorized in accordance with section 27 BStMG to request provision of a provisional security deposit or, if the stipulated provisional security deposit is not provided, to request that the trip be interrupted and prevent its continuation by taking suitable preventative measures (e.g. confiscation of vehicle documents and keys, clamping of the vehicle, parking it in a suitable place and other similar measures) in accordance with section 28 BStMG.

6.2. CONFISCATION OF LICENSE PLATE NUMBER RELATED CARDS

Toll enforcement officers are entitled to confiscate license plate number related cards in case these cards are used for not permitted vehicles.

7. TOLL EVASION

7.1. PENALTIES FOR TOLL EVASION

Drivers who use – according to Part A II – sections on which tolls are levied (section toll segments) without paying the required toll amount properly are in breach of an administrative rule, which is a toll evasion in accordance with section 20(1) BStMG. This breach of an administrative rule will be fined between € 300.00 and € 3,000.00 by the local district administrative authorities.

An example for this breach of an administrative rule is the following: The driver of a vehicle with a maximum gross vehicle weight of up to 3.5 t (category 1) is using the open lane of a certain toll road section (see Part A II, section 2.2. “Open toll lane operation”). This lane is strictly reserved for vehicles with a maximum gross vehicle weight of over 3.5 t. There is a drive ban on this particular lane for vehicles with a maximum gross vehicle weight of up to 3.5 t according to the Road Traffic Act (StVO).

7.2. NON-IMPOSITION OF A PENALTY

A penalty is not imposed if the driver pays a substitute toll, which is defined below (section 7.3). A substitute toll, which is paid in due time and in proper form, cannot be reclaimed.

7.3. SUBSTITUTE TOLL

7.3.1. Method of payment

The substitute toll may not be paid in instalments. If instalments are received, they will be credited to the payer’s account minus a processing fee of € 15.00 (including 20 % VAT). The same applies to late payments, payments that do not include the correct identification number (ID no.), or any payments made to any account other than the one indicated on the copy of the request to pay the substitute toll. In the event of overpayment by less than € 5.00, no money will be credited to the payer’s account (otherwise the entire amount will be credited to the payer’s account).

7.3.1.1. Apprehension by toll enforcement officers

If the driver of the vehicle is apprehended by toll enforcement officers, the toll enforcement officer is authorized to verbally request that the driver pays the substitute toll. The substitute toll must be paid immediately on request either in cash or using an authorized means of payment mentioned in appendix 2. The driver will be given confirmation of payment.

7.3.1.2. Retroactive summons procedure

If a violation is discovered by means of automatic checks without the driver being apprehended in person, the registered owner(s) may receive a written request to pay the substitute toll. This written request will provide details of the substitute toll to be paid, an identification number (ID No.), and details of a bank account.

The substitute toll must be transferred to the account indicated in the written request and must include the identification number (ID No.) given thereon. The obligation to pay the substitute toll is met when the substitute toll has been credited to the given account within four weeks of the issuing of the request and as long as the transfer order contains the complete and correct identification number, which must be written in such a way that it can be automatically read by a machine.

7.3.2. Substitute toll rate

The substitute toll rates (including 20 % VAT) for non-payment of the required toll are given below:

| Vehicle category | Substitute toll rate |
|---|----------------------|
| A (i.e. single-track vehicles) | € 65.00 |
| B (i.e. twin-track vehicles with a maximum gross vehicle weight of up to 3.5 t) | € 120.00 |

7.3.3. Continuing the journey with a substitute toll receipt

The payment of the substitute toll allows the driver to use the section on which tolls are levied (and for which the required toll amount was not paid properly) only once and only on the particular day of offense. As a confirmation of paying the receipt of the paid substitute toll by the time of apprehension can be shown.

If apprehended by the toll enforcement officers the substitute toll is not being paid (even on request), the section toll segment needs to be left at the next possible exit (regardless of how the road continues). A failure to comply fulfils the offense of toll evasion.

7.3.4. Payment of the substitute toll

Substitute tolls must be paid in euros. Information regarding the means and methods of payment that are accepted for payment of the substitute toll to toll enforcement officers is given in appendix 2 as well as on the Internet at www.asfinag.at respectively by the ASFINAG Service Center.

8. VIOLATION OF THE OBLIGATION TO STOP

Drivers who, contrary to section 18(2) BStMG, do not stop when requested to do so by an officer defined in section 9 are in breach of an administrative rule according to section 21 BStMG and must be fined up to **€ 3,000.00**.

PART B: TOLLING REGULATIONS FOR TWIN-TRACK VEHICLES WITH A MAXIMUM GROSS VEHICLE WEIGHT OF MORE THAN 3.5 T

1 GENERAL INFORMATION

The distance-related toll is collected using a fully electronic toll system.

The entire toll road network is divided up into toll road sections, whereby the toll for each individual toll road section is collected separately. The distance-related toll serves the surcharges of the infrastructure costs as well as the costs for traffic-related air and noise pollution.

To ensure correct payment of the toll, an authorized, correctly functioning, and permanently and properly attached on-board unit (a GO-Box or a Split GO-Box, both hereinafter referred to as 'GO-Box'—see section 5.7.1 of Tolling Regulations Part B—or another authorized on-board unit—see section C) must be carried in the vehicle that is liable for the toll. In principle, steel structures (so-called toll collection points or toll gantries—see illustration 13) fitted with antenna (radio beacons) are installed over the carriageway between the individual junctions on the toll road network.



Illustration 13

When a vehicle passes a toll collection point, the on-board unit in the vehicle communicates with the toll collection point's antenna over the road by means of microwave technology and consequently initiates toll collection (also referred to as a toll transaction or toll charging).

In accordance with section 7.3, ASFINAG reserves the right to bill users retroactively and automatically for the toll that must be paid on specific toll road sections without necessarily erecting a toll collection point on that specific toll road section. The toll road section rates that apply to these sections are listed according to category and toll rate group in appendix 4.

In accordance with section 4 of the Federal Road Tolls Act 2002 as amended (BStMG), drivers and registered owners (both hereinafter referred to as 'customer') are jointly liable to pay the toll.

In the following, the term "customer" applies to the registered owner, the driver or a third party attributable to the registered owner (for example a dispatcher, secretary or fleet manager).

2 SCOPE OF APPLICATION

Tolling Regulations Part B applies to all twin-track vehicles with a maximum gross vehicle weight of more than 3.5 t. These vehicles are liable for a distance-related toll.

Drivers of twin-track vehicles that have not yet been registered and carry trade plates are obliged to pay the distance-related toll as long as the service weight of their vehicle exceeds 3.5 t. When driving a vehicle with trade plates, drivers must carry a copy of the vehicle's logbook or evidence of the service weight of the vehicle provided by the car manufacturer or his authorized

sections of motorway or expressway are excluded from the mandatory distance-related toll system:

- the section of the S 5 Stockerauer expressway between the Jettsdorf intersection (S 33) and the Krems junction (regional highway B 3, regional highway B 37).

3.1.1 Areas with existing section toll

The distance-related toll also applies for the use of the motorways and expressways with existing toll points (A 9, A 10, A 11, A 13, and S 16). It is no longer possible to pay the toll for vehicles with a maximum gross vehicle weight of more than 3.5 t manually at existing toll booths. Vehicles may only drive through existing main toll points on the specially marked lanes. Depending on traffic volume, so-called open toll lane operation or mixed toll lane operation may be used on these lanes.

3.1.1.1 Mixed toll lane operation

During mixed lane operation, the toll lane may be used by both vehicles with a maximum gross vehicle weight of up to 3.5 t (see Tolling Regulations Part A II) and vehicles with a maximum gross vehicle weight of more than 3.5 t (see corresponding signs in illustration 16a below). The barrier used for mixed toll lane operation is automatically raised for vehicles with a maximum gross vehicle weight of more than 3.5 t if the distance-related toll has been correctly paid. If this is not the case, the barrier remains down. In this case, instructions given by the toll point personnel must be followed. All lanes at secondary toll points are mixed toll lanes. This means that there are no special toll lane operation signs at the secondary toll points at the Zederhaus and St. Michael/Lungau junctions on the A 10 and the Zenzenhof, Igls Patsch, Schönberg Stubaital, Matrei Steinach, Nösslach, and Brennersee junctions on the A 13.

3.1.1.2 Open toll lane operation

During open toll lane operation, one lane is strictly reserved for vehicles that are liable for the distance-related toll only. This lane will be clearly marked as such (see illustration 16b).

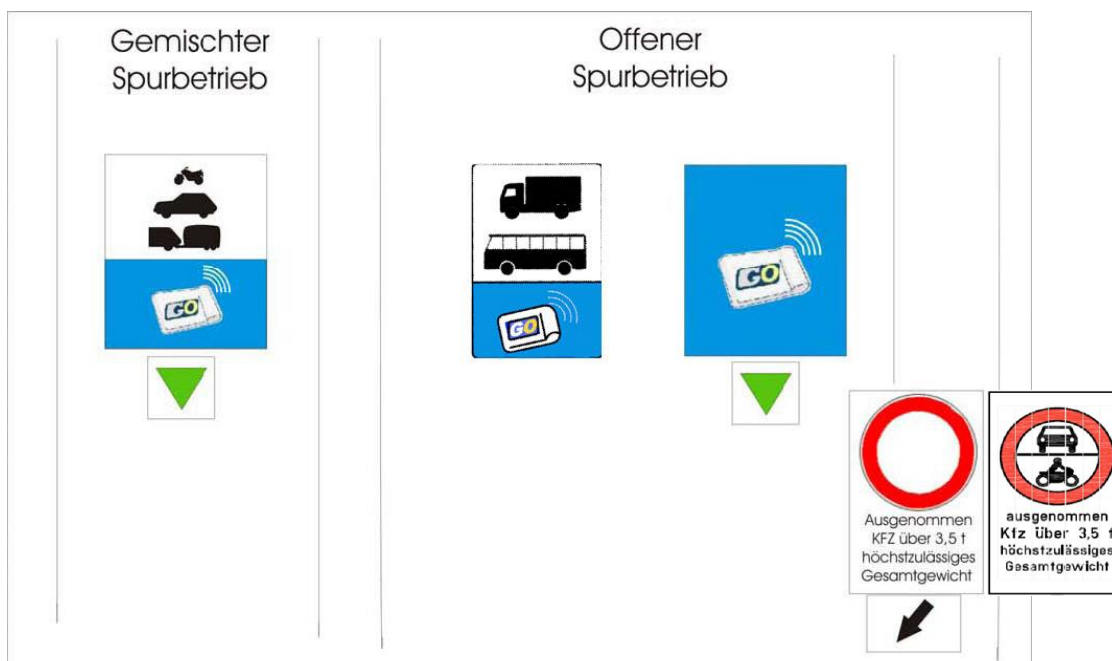

Illustration 16a: 'mixed lane operation'

Illustration 16b: 'open lane operation'

In this open lane operation, this lane is prohibited for vehicles with a maximum gross vehicle weight of up to 3.5 t (category 1) by a driving ban according to the Road Traffic Act (StVO). Category 1 vehicles are not permitted to use this lane. Drivers who violate this prohibition are in breach of an administrative rule (see Part A II, section 6.2).

3.1.2 The mandatory toll in areas around road works

The mandatory toll must be paid in full for areas around road works. The mandatory toll must also be paid in full for road works that require traffic to use different lanes or carriageways, or on sections where contraflow systems have been introduced. Vehicles travelling to or from the works area are also liable to pay the toll.

Only trips made on the carriageways that are closed to traffic are an exception to this rule. This exemption requires that the vehicle that is liable for the toll is correctly registered with the system in accordance with section 5, and that the GO-Box in the vehicle (both for the pre-pay and post-pay procedures) is deactivated, for example by properly attaching the shield cover that is available from ASFINAG Maut Service GmbH at GO points of sale (see section 5.3). To this end, the cover must be wrapped at least three times around the GO-Box and subsequently closed securely using staples or adhesive tape. If the GO-Box is not deactivated, toll transactions will be triggered or tolls collected automatically. If this happens, the collected tolls will not be refunded.

3.1.3 Temporary entries and exits in accordance with section 26(2) Federal Highways Act

The existence of entries and exits in accordance with section 26(2) of the Federal Highways Act 1971 (i.e. temporary entries and exits from the toll road network in conjunction with infrastructure projects that are being carried out in the public interest) does not affect in any way the toll road sections and toll road section rates. Depending on the location of the toll collection station on the one hand and the entries and exits created within a toll road section on the other, the toll road section rate must be paid in full if the vehicle passes a toll collection station that is used to collect the rate for that toll road section, even if only part of the toll road section is used.

3.2 Signing

Information signs on federal and regional highways leading to border crossings for motor vehicle traffic notify road users of the mandatory toll (see illustrations 17 and 18 below). Road users are also notified of the mandatory toll on additional information signs on all approach roads leading to motorways and expressways on which tolls are levied (see illustration 19 below).



Illustration 17*



Illustration 18*

Illustration 19*

(*)The toll sticker (vignette) symbol refers to the toll for which vehicles with a maximum gross vehicle weight of up to 3.5 t are liable, see Tolling Regulations Part A I for details

3.3 Exemptions from the mandatory toll

3.3.1 Permanent exemptions

Only the vehicles listed below are permanently exempt from the mandatory toll:

- Vehicles with visible blue headlights or warning lights in accordance with section 20(1)(4) and (5) of the Motor Traffic Act 1967 (hereinafter referred to as 'KFG' for short). In the case of vehicles in accordance with section 20(5) KFG, an exemption from the mandatory toll exists only for the time the blue headlights or warning lights are used and if the usage corresponds to the restrictions and conditions given in section 20(6) KFG. The return journey of an operational vehicle, which used blue headlights or warning lights, is also exempt from the mandatory toll.
- Army vehicles (section 2(1)(38) Motor Traffic Act 1967).
- Vehicles that are used within the scope of the agreement among the states party to the North Atlantic Treaty and the other states participating in the Partnership for Peace regarding the status of their forces ('PfP-SOFA', BGBl. III No. 136/1998). If non-military vehicles are used for these trips, they shall provisionally be subject to the provisions for the payment of the distance-related toll. The toll paid in the course of these trips will be refunded by ASFINAG free of charge. Applications for refunds must be submitted by the relevant state authorities once the trips have been completed. Refund applications must be accompanied by evidence that the toll was paid and submitted directly to ASFINAG Maut Service GmbH (see appendix 7b).
- Vehicles that are used for the implementation of measures for securing peace within the scope of an international organisation, the Organisation for Security and Co-operation in Europe, or the European Union in conformity with a Decision made within the scope of the Common Foreign and Security Policy. If non-military vehicles are used for these trips, they shall provisionally be subject to the provisions for the payment of the distance-related toll. The toll paid in the course of these trips will be refunded by ASFINAG free of charge. Applications for refunds must be submitted by the relevant state authorities once the trips have been completed. Refund applications must be accompanied by evidence that the toll was paid and submitted directly to ASFINAG Maut Service GmbH (see section 14).
- Vehicles belonging to the public security forces, tax authorities, prison services, and foreign security forces in accordance with section 2(3) of the Police Co-operation Act, BGBl. No. 104/1997, as well as vehicles belonging to foreign customs and judicial authorities as long as blue headlights or warning lights are attached to these vehicles and are visible. Confiscated vehicles that use the toll road network and to which an official tax authority registration number has been attached are not liable for the toll.
- Vehicles belonging to foreign public emergency services, foreign fire brigades or foreign rescue services. These vehicles are exempt from the mandatory toll if the blue headlights or warning lights have been visibly attached to the exterior and only for the time those headlights and warning lights are used.

Vehicles that have blue headlights or warning lights visibly attached to the exterior, but are not registered and carry therefore trade plates or other equivalent plates and that use the toll road network are not exempt from the mandatory toll.

3.3.2 Temporary exemptions

In addition to the above provision, ASFINAG may in accordance with section 5(2) BStMG and depending on the circumstances, exempt vehicles with a maximum gross vehicle weight of more than 3.5 t that are delivering humanitarian aid in the event of emergencies or disasters from the mandatory toll.

To obtain such an exemption, which allows a trip to be completed without payment of the toll (i.e. no GO-Box or other authorized on-board unit must be fitted in the vehicle), an exemption application form (see appendix 3b) must be completed on the INTERNET at www.go-maut.at and subsequently printed out at least 30 minutes before use of the toll road network. The completed, printed form must then be duly signed. If no Internet connection is available, the applicant must call the ASFINAG SERVICE CENTER (the telephone number is given in section 5.3 and in the information in section 13). The application form will then be completed by the ASFINAG SERVICE CENTER agent in accordance with the details provided by the applicant and then faxed to the applicant. This fax must then be duly signed. Each application has a specific application number and is only valid for a freely selectable calendar day. In the event of national disasters, ASFINAG reserves the right to grant an exemption from the mandatory toll for a period of more than one day. The fully completed and signed application form (original) must be carried in the vehicle for the duration of the trip that is exempt from the mandatory toll and must be presented on request as evidence of exemption approval. Before starting the journey, the applicant is obliged to request the activation of the exemption from the mandatory toll. To this end, the applicant should call the ASFINAG SERVICE CENTER (the telephone number can be found in section 5.3 and the information in section 13) and provide the registration number of the vehicle and the specific application number.

If the vehicle in question is fitted with a GO-Box or another authorized on-board unit, the following provisions must be observed: Exemption from the payment of the toll requires that the GO-Box used for the pre-pay procedure (see sections 5.5.1 and 5.5.3) is deactivated by the customer for the duration of the trip that is exempt from the mandatory toll, for example by properly attaching the shield cover that is available from ASFINAG Maut Service GmbH at GO points of sale (see sections 5.3). To this end, the cover must be wrapped at least three times around the GO-Box and subsequently closed securely using staples or adhesive tape.

If the GO-Box for pre-pay procedures is not deactivated, toll transactions will be triggered or tolls collected automatically. If this happens, the collected tolls will not be refunded.

These instructions do not apply to GO-Boxes that are used for the post-pay procedure or other authorized on-board units (see sections 5.5.1 and 5.5.2). Consequently, the GO-Box must not be deactivated and may remain in the vehicle. This provision applies exclusively to those cases that result from a cause within the meaning of section 5(2) of the Federal Road Tolls Act and which is announced at this point in the Tolling Regulations.

3.3.3 Special exemptions

Vehicles that are towed away are exempt from the distance-related toll for the duration of the towing procedure. Neither the axles of the vehicle being towed away, nor the axles of any attached trailers or motorcaravans that also have to be towed away increase the category that must be set for the towing vehicle. This exemption requires that the GO-Box in the vehicle being

towed away (both for the pre-pay and post-pay procedures) is deactivated, for example by properly attaching the shield cover that is available from ASFINAG Maut Service GmbH at GO points of sale (see section 5.3). To this end, the cover must be wrapped at least three times around the GO-Box and subsequently closed securely using staples or adhesive tape. If the GO-Box is not deactivated, toll transactions will be triggered or tolls collected automatically. If this happens, the collected tolls will not be refunded.

Please note that in accordance with section 46(3) StVO 1960, the vehicle being towed away must leave the motorway or expressway immediately at the next exit (junction).

4 TOLL RATES

The toll rates are based on the Federal Road Tolls Act 2002 as well as the relevant Toll Rate Ordinance (Mauttarifverordnung). The Toll Rate Ordinance determines in particular the base kilometre toll rate for surcharges concerning the infrastructure as well as surcharges for traffic-related air pollution costs and surcharges for traffic-related noise pollution costs. Furthermore the Toll Rate Ordinance categorises the EURO emission classes into rate groups and sets the toll rates for each group. Moreover it also states the differences between the toll rates due to the number of axles of the vehicle itself and their pulling trailer (see section 9 (3) BStMG).

Based on this provisions the Tolling Regulations sets in appendix 4 (toll road section rate charts) for each toll road section the actual valid toll rates per road section for the overall costs as well as the costs for traffic-related air and noise pollution. These calculated toll rates per road section are listed without VAT.

To read the toll rates per road section charts more easily, each toll road section is named after the junction respectively intersection according to the signs on those roads on which toll is being charged. The toll rates per road section stay the same in case of road works, temporary relocations or other time related bans of junctions.

For the post-pay contracts all net-toll rates will be summed up for each vehicle registration and its allocated means of payment on a daily basis (daily sum). Based on the daily sum the VAT will be calculated and added which results in the gross-toll rate for the day. For the pre-pay contracts the VAT will be paid when charging the toll amount on the device.

The EURO emission class is a characteristic of the vehicle and is determined – on the basis of EU directives - by the limit values for emissions. The EURO emission class entered in the system for a particular vehicle depends on the emission limit values respected by the engine installed in that vehicle.

In accordance with the valid version of the Toll Rate Ordinance, the following toll rate groups in order to surcharge for infrastructure apply:

| TOLL RATE GROUP | EURO EMISSION CLASS |
|-----------------|---------------------|
| A | EURO VI |
| B | EURO 0 to EEV |

In accordance with the valid version of the Toll Rate Ordinance, the following toll rate groups apply in order to surcharge traffic-related air pollution costs:

| TOLL RATE GROUP | EURO EMISSION CLASS |
|-----------------|---------------------|
| A | EURO VI |
| B | EURO V and EEV |
| C | EURO IV |
| D | EURO 0-III |

The basic kilometre rate for traffic-related noise pollution will be differentiated by time (day/night). The “night” rate is defined by the time period between 10 pm and 5 am. The time registered in the toll system at the time the vehicle passes the appropriate toll collection point is decisive when it comes to determining whether the night-time rate applies (the time on the radio-controlled clock is used as a reference).

According to the Toll Rate Ordinance the basic kilometre rate for surcharges concerning traffic-related air pollution and traffic-related noise pollution is not valid on the road A 12 between the national border Kufstein and the Innsbruck/Amras intersection (A 13) as well as the whole A 13 motorway.

If a vehicle that was classified before 3 January 2009 does not have EURO I-VI classification, the following concordance table applies.

| | |
|----------|--------|
| EURO I | Euro 1 |
| EURO II | Euro 2 |
| EURO III | Euro 3 |
| EURO IV | Euro 4 |
| EURO V | Euro 5 |
| EURO VI | Euro 6 |

Concerning the differentiation of toll rates due to the number of axles the following applies:

The whole number of lift axles, tandem axles, and twin axles must be counted for the purpose of this provision. Support axles and trailers that are attached to buses or motor caravans as described in section 2(1) (28a) of the Motor Traffic Act 1967, on the other hand, must not be taken into account when counting the number of axles.

The toll rates for the toll road sections mentioned in section 10 (2) BStMG are also based on the Toll Rate Ordinance as well as section 9 BStMG.

Registered owners of vehicles in category 4, to which the night-time rate on the A 13 does not apply, but for which a toll is collected for technical reasons, may apply to have the difference between the night-time rate and the normal rate refunded within six months of travelling on the toll road section in question. The application form is available from the Schönberg main toll point and on the Internet at the ASFINAG website (www.asfinag.at). The following documents must be submitted with the first application:

- information concerning the toll road section used and the time of passage (itemized toll information sheets or transaction information, i.e. the information about the last 30 transactions stored in the GO-Box, at GO points of sale)
- a copy of the vehicle registration documents
- name of account holder and bank account details for the transfer of the refunded amount.

As long as there is no change in the aforementioned data, only the toll road section used and the time of passage must be indicated when submitting further refund applications for the same vehicle. Applications for refunds must be submitted by post or fax to ASFINAG Maut Service GmbH (see section 13).

If the toll for the trip is paid using the pre-pay procedure, the driver of the vehicle must ensure that there is enough toll credit in the GO-Box to cover the toll. Partial non-payment of the toll resulting from insufficient toll credit in the GO-Box shall be treated as a toll evasion offence and incurs all the relevant consequences and penalties.

The rate stipulated in the Toll Rate Ordinance for the section between the St. Jakob/Rosental junction and the national border in the Karawanken tunnel only applies for Slovenia-bound trips. The toll for Austria-bound trips is collected by DARS d.d. Družba za avtoceste v Sloveniji (see www.dars.si) on its own behalf and for its own account in accordance with the toll rates stipulated in Slovenia.

5 REGISTERING WITH AND DEREGISTERING FROM THE TOLL SYSTEM

5.1 General information

In accordance with section 8(1) BStMG, the drivers of vehicles that are liable for the toll are obliged to equip their vehicles with authorized on-board units for electronic collection of the distance-related toll in accordance with the provisions of Tolling Regulations before using the toll road network.

This obligation includes

- registering with the toll system (system registration for the post-pay or pre-pay procedure; see section 5.5),
- the acquisition of an authorized on-board unit,
- and the permanent, proper attachment of this unit to the vehicle that is liable for the toll (see section 8.1).

There are no plans for other forms of toll collection. Retroactive payment of the toll is only possible in certain circumstances (see sections 7.1 and/or 7.2). The vehicle registration documents for the vehicle that is liable for the toll must be presented for registration with the toll system.

Only the following on-board units are authorized for electronic toll collection:

- ASFINAG on-board units: the GO-Box or the Split GO-Box (see section 5.7),
- On-board units that have been specifically authorized by the operators of foreign toll systems (see section C). Motor traders using an authorized on-board unit are not subject to the special provisions in section 5.6.6).

5.2 Declaration of the relevant EURO emission class

As a rule, vehicles are allocated in each case to the highest toll rate group and the EURO emission class 0 or I is entered in the central system and on the GO-Box for the relevant vehicle registration number, unless the driver has requested or requests the entry of a better EURO emission class (hereinafter referred to as the 'requested EURO emission class'). For this reason, it is not necessary for drivers of vehicles with EURO emission classes 0 to III to make a declaration at a GO point of sale or to provide evidence of the EURO emission class.

For this reason, the driver must expressly request the entry of a specific EURO emission class when registering for the toll system, declaring a EURO emission class, or changing his/her data (see section 5.6) at a GO point of sale. In order to do so, the GO-Box must be presented at the GO point of sale.

The legitimacy of the entry of the requested EURO emission class will not be checked at the GO point of sale. It is not, therefore, necessary to prove the legitimacy of the requested EURO emission class at the GO point of sale. ASFINAG must be provided with documents that provide evidence of the legitimacy of the requested EURO emission class either in advance (see section 5.2.2.2) or at a later date (see section 5.2.2.1). The expressly requested EURO emission class is entered into the GO-Box and the central system at the GO point of sale and is therefore immediately applicable for all tolls.

A claim to the billing of the toll rate allocated to the relevant toll rate group only arises when the EURO emission class has been stored on the GO-Box at the GO point of sale and the verification process has been concluded with a positive outcome. Refer to section 5.2.2 with regards the deadline for evidence.

Once the the requested EURO emission class is entered at the GO point of sale, a vehicle declaration is issued which identifies

- the requested and stored EURO emission class
- the official vehicle registration number stored in the GO-Box and
- the GO-Box identification number which is stored in the GO-Box.

This vehicle declaration must always remain in the vehicle.

A customer receipt of the stored vehicle data is also issued when the EURO emission class is entered. This contains the following information:

- the vehicle registration number concerned and the GO-Box identification number,
- the date and time of the EURO emission class entered at this time and
- deadlines to be observed by the registered owner, where applicable.

The requested EURO emission class is instantly visible

- on itemized toll information sheets (section 6),
- on all other print-outs from a GO point of sale and
- in the SelfCare portal.

If a vehicle is not subject to the EURO emission classes listed in appendix 0 of Directive 1999/62/EC, the driver must make this fact known at the GO point of sale. Here too, corresponding evidence must be provided and verified. It is only after the driver has declared the

requested EURO emission class at the GO point of sale that the vehicle (vehicle registration number) will be allocated in each case to the lowest toll rate group. The driver must carry the corresponding vehicle declaration throughout the trip (see section 8).

5.2.1 Declaration of the EURO emission class

5.2.1.1 Declaration of the EURO emission class by the registered owner

For the purposes of the declaration of the EURO emission class, the registered owner can request the entering of a specific EURO emissions class at a GO point of sale.

Once the EURO emission class has been entered at a GO point of sale, the vehicle declaration is issued. By checking the vehicle declaration which has been issued, the registered owner is to ensure that

- the official vehicle registration number stored in the GO-Box is the same as the actual vehicle registration number attached to the vehicle and
- the GO-Box identification number of the GO-Box in the vehicle is the same as the GO-Box identification number in the vehicle declaration and
- the requested EURO emission class was stored according to the registered owner's declaration.

If the registered owner notices any discrepancies, he/she must request that the information be corrected immediately at the GO point of sale. Failure to comply with this provision constitutes a toll evasion offence in accordance with section 10. This obligation to check also applies to reprints or when a new vehicle declaration is being issued. Generally, the vehicle declaration is to be carried by the driver during the trip (see section 8).

A customer receipt is also issued which the registered owner is obligated to check.

5.2.1.2 Declaration of the EURO emission class by a third party designated by the registered owner

The registered owner is permitted to instruct a third party (particularly the driver) to request the entry of a specific EURO emission class at a GO point of sale. In this case, the third party acts as a representative of the registered owner and takes over the declaration of the EURO emission class for them.

A vehicle declaration is also issued in this instance, once the EURO emission class has been entered at a GO point of sale. The third party is to check the vehicle declaration, in order to ensure that

- the official vehicle registration number stored in the GO-Box is the same as the actual vehicle registration number attached to the vehicle and
- that the GO-Box identification number of the GO-Box in the vehicle is the same as the GO-Box identification number in the vehicle declaration and
- that the EURO emission class given to the third party by the registered owner was stored accordingly.

If the third party notices any discrepancies, he/she must request that the information be corrected immediately at the GO point of sale. Failure to comply with this provision constitutes a

toll evasion offence in accordance with section 10. This obligation to check also applies to reprints or when a new vehicle declaration is being issued. Generally, the vehicle declaration is to be carried by the driver during the trip (see section 8).

The registered owner is responsible for the correctness of the EURO emission class declaration. To this end, the registered owner is to promptly request that the third party hands over the customer receipt to the registered owner in order to ensure that the required evidence can be provided in time (see section 5.2.2.).

If after the customer receipt has been handed over, the registered owner determines that an incorrect EURO emission class has been entered, then the registered owner is to immediately enter the correct EURO emission class at a GO point of sale or allow a third party to do so. Express reference is made to the possibility of retroactive toll payment in accordance with section 7. Refunds will not be given for excess toll payments made in the period before the new EURO emission class is entered.

5.2.2 Checking the requested EURO emission class/allocation to a toll rate group (verification)

If the entry of a requested EURO emission class is requested, ASFINAG must be provided with evidence of the legitimacy of the requested and entered EURO emission class in the form of suitable documents (see section 5.2.3).

The registered owner will be informed of the obligation to provide such evidence in the form of a customer receipt that will be given to the registered owner at the GO point of sale in German and, if available, in the national language of the country in which the vehicle is registered. If a customer receipt is not available in that language, the driver will be given a customer receipt in English. If the entry of a requested EURO emission class at a GO point of sale is made by a third party designated by the registered owner, then the third party is to give the registered owner the customer receipt and the registered owner is obliged to request this information from the third party.

If the requested EURO emission class is allocated to the toll rate groups for which in each case the highest rate has been set (hereinafter referred to as the 'highest toll rate groups'), it is not necessary to provide evidence. This is the rule for the EURO emission classes EURO 0, I, II, and III, as there is no need to send proof documents for those classes. The registered owner will be informed of the fact that he/she need not provide such evidence through an appropriate customer receipt that will be issued at the GO point of sale in German and, where available, in the national language of the country in which the vehicle is registered. If a customer receipt is not available in that language, the customer receipt will be in English.

Evidence of the legitimacy of the requested EURO emission classes that are not allocated to the highest toll rate groups can be provided

- subsequently, after the EURO emission class has been entered at the GO point of sale (for information on subsequent verification, see section 5.2.2.1) or

- in advance, before the EURO emission class has been entered at the GO point of sale (for information on verification in advance, see section 5.2.2.2).

This is the case for the EURO emission classes IV, V, EEV and VI, as for those classes, confirmation documents are required.

5.2.2.1 Subsequent verification

Evidence is not verified by staff at the GO point of sale, but centrally by ASFINAG. The necessary documents (see section 5.2.3) must be sent to ASFINAG. There are a number of possible ways of doing so:

a) by post

In this case, the documents must be sent to the following postal address:

ASFINAG Maut Service GmbH
z.H. ASFINAG SERVICE CENTER / Emissionsklassen
Alpenstrasse 99
A-5020 Salzburg
AUSTRIA

b) by fax

In this case, the documents must be sent to the following fax number:

ASFINAG Maut Service GmbH
z.H. ASFINAG SERVICE CENTER / Emissionsklassen
+43 50108 912913

c) by e-mail

The necessary documents may be provided in the following formats:

- pdf
- jpg
- tif

Documents should be sent to the following address for verification:

euroclass@asfinag.at

The necessary documents sent by e-mail are considered sent when receipt of the e-mail is confirmed in the form of a response e-mail from ASFINAG to the sender.

d) via the SelfCare portal

All registered SelfCare users can send the necessary documents for their vehicle (registration number registered with the toll system) to the following address for verification: www.go-maut.at .

The necessary documents may be provided in the following formats:

- pdf
- jpg
- tif.

The documents needed for verification must be made available to ASFINAG (i.e. arrive at ASFINAG) within **28 calendar days** (hereinafter referred to as the 'submission deadline'), starting with the day the EURO emission class requested was entered at a GO point of sale.

To facilitate the process, ASFINAG has prepared an application form that must be filled out and submitted with the documents. This application form, which is available in a variety of languages,

- can be downloaded from
 - the SelfCare portal (www.go-maut.at) or
 - www.asfinag.at;
- can be requested from the ASFINAG SERVICE CENTER.

There are no plans to make it possible for drivers to send documents directly from the GO point of sale. If the necessary documents are sent to ASFINAG before the submission deadline, ASFINAG will begin verification of the documents as soon as they arrive.

5.2.2.1.1 Complete, legible, and timely submission of the suitable documents

If the requested and entered EURO emission class can be verified on the basis of the submitted documents, the verification procedure is concluded with a positive outcome. This positive outcome can be viewed in the SelfCare portal. Furthermore it is possible to ask the ASFINAG SERVICE CENTER for information about the processing status and outcome of the verification process. In the event of a positive outcome, there is legal certainty about the requested and entered EURO emission class.

5.2.2.1.2 Incomplete and/or faulty documents that have been submitted before the submission deadline

If the necessary documents are sent to ASFINAG before the submission deadline, but are found to be faulty (e.g. illegible) or incomplete, ASFINAG will request the driver once only to re-submit the missing and/or incomplete documents. In order to make it possible for ASFINAG to send such queries or requests, it is essential that the driver provides a valid contact address on the application form.

If it is possible to make a request for re-submission, the submission deadline for submission of the missing and/or incomplete documents is extended once by seven days to a maximum total of 35 calendar days.

If, after ASFINAG's request for re-submission, the necessary documents are submitted properly and in time and if the legitimacy of the requested and entered EURO emission class can be verified, the verification procedure is concluded with a positive outcome. The provisions of section 5.2.2.1.1 shall apply accordingly.

If ASFINAG's request for re-submission is only partially met or not met at all, the verification process is concluded with a negative outcome. In this case, the provisions of section 5.2.2.1.4 shall apply accordingly

If no valid contact address is provided, the verification process is concluded with a negative outcome. In this case, the provisions of section 5.2.2.1.4 shall apply accordingly.

5.2.2.1.3 Documents for the wrong emission class are submitted by the submission deadline

If documents that show that the wrong EURO emission class was requested and entered at a GO point of sale are submitted by the submission deadline, ASFINAG will differentiate between the following cases:

- a) Allocation of the EURO emission class on the basis of the submitted documents to a toll rate group that results in the payment of a lower toll rate*

In this case, the EURO emission class determined by the verification of the submitted documents will be entered in the central system.

Two brief acoustic signals (see section 8.2.4.3.1) alert the driver to the fact that he/she must go to a GO point of sale to change the EURO emission class stored in the system for his/her vehicle. If the driver ignores the signal and does not go to a GO point of sale, the GO-Box will be intentionally deactivated. The driver will be alerted to this deactivation by four brief acoustic signals (see section 8.2.4.3.2). The next time the driver visits a GO point of sale, the entered EURO emission class will automatically be changed to the EURO emission class determined by the documents submitted for verification. The driver will then be given a new vehicle declaration by staff at the GO point of sale, whereby the old vehicle declaration automatically becomes invalid. Therefore the new vehicle declaration must remain in the vehicle.

- b) *Allocation of the EURO emission class on the basis of the submitted documents to a toll rate group that results in the payment of a higher toll rate*

In this case, ASFINAG will not wait for the submission deadline, but will instead deactivate the GO-Box immediately, whereby the provisions of section 5.2.2.1.4 shall apply.

- c) *Entry of an incorrect EURO emission class within a toll rate group*

In this case, the EURO emission class determined by the verification of the submitted documents will be entered in the central system.

If the documents submitted as evidence show that the EURO emission class for which evidence was provided would lead to the collection of a lower toll rate in the event of a change in the allocated toll rate group, and if such a change in the allocated toll rate group does occur, two brief acoustic signals (see section 8.2.4.3.1) will alert the driver to the fact that he/she must go to a GO point of sale to change the EURO emission class stored in the system for his/her vehicle. If, despite the signals, the driver does not go to a GO point of sale, the GO-BOX will be intentionally deactivated. The driver will be alerted to the deactivation by four brief acoustic signals (see section 8.2.4.3.2).

If a change in the allocated toll rate group instead leads to the collection of a higher toll rate, the GO-BOX will be intentionally deactivated immediately in order to inform that the wrong EURO emission class has been entered in the system so that he/she has the opportunity to request (and provide evidence for) the entry of the correct EURO emission class. In this case, the driver will not be alerted in advance by two brief acoustic signals (see section 8.2.4.3.1), but will instead be alerted to the deactivation by four brief acoustic signals (see section 8.2.4.3.2).

In both cases, the next time the driver visits a GO point of sale, the entered EURO emission class will automatically be changed to the EURO emission class determined by the documents submitted for verification. The driver will then be given a new vehicle declaration by staff at the GO point of sale, whereby the old vehicle declaration automatically becomes invalid. Therefore the new vehicle declaration must remain in the vehicle.

5.2.2.1.4 No documents are submitted by the submission deadline

If no documents are submitted by the 28-day submission deadline (see section 5.2.3), the GO-BOX will be deactivated. The driver will be alerted to the deactivation by four brief acoustic signals (see section 8.2.4.3.2). When the driver visits the next GO point of sale, the EURO

emission class 0 will automatically be entered in the GO-BOX because of the lack of suitable evidence and the GO-Box will be re-activated. For the period of time that has elapsed since requesting and entering the EURO emission class for which no evidence was provided by the stipulated submission deadline, a toll evasion offence in accordance with section 10 will have been committed if the road network subject to toll has been used by the vehicle.

5.2.2.1.5 Documents are submitted, but not by the submission deadline

If the documents are submitted after the submission deadline, the GO-BOX will be deactivated after the deadline elapses, whereby the provisions of section 5.2.2.1.4 shall apply accordingly. Any documents submitted after this point will be considered a new application and the provisions of section 5.2.2.2 shall apply accordingly.

5.2.2.2 Verification in advance

Only owners of vehicles with registration numbers that have been properly registered with the toll system (i.e. for which a valid contract exists) have the opportunity to send ASFINAG documents for verification before entering a EURO emission class at a GO point of sale (see section 5.2.1). ASFINAG is not obliged to verify documents submitted by owners of vehicles with registration numbers that do not have a valid toll contract. If such documents are nevertheless submitted, ASFINAG is not obliged to keep these documents for verification at a later date.

Once ASFINAG has completed the verification, the EURO emission class for which evidence was provided will be entered in the central system.

Entry of the EURO emission class must also be requested at a GO point of sale when using the verification-in-advance process. If the EURO emission class requested is the same as the EURO emission class for which evidence was provided in advance, this EURO emission class is entered in the GO-Box. In this case, the GO point of sale will issue the vehicle declaration and a customer receipt in German and, where available, in the national language of the country in which the vehicle is registered, stating that no further evidence need be supplied. If a customer receipt is not available in that language, the customer receipt will be in English.

A different EURO emission class can be requested at the GO point of sale (discrepancy), regardless of the EURO emission class which is already entered in the central system (proven in advance). A customer receipt is also issued in this case, which shows the (requested) EURO emission class which is now stored in the GO-Box and which identifies obligations, where applicable (e.g. possible course of deadlines for evidence). In this case, the GO point of sale will issue a vehicle declaration about the requested and newly entered EURO emission class as well as a customer receipt in German and, where available, in the national language of the country in which the vehicle is registered. If a customer receipt is not available in that language, a customer receipt will be issued in English.

If there is a valid contract and if the documents submitted as evidence (in advance) show that the EURO emission class for which evidence was provided is not the same as the EURO emission class stored in the GO-Box, the following cases are to be differentiated between:

- a) If the documents submitted as evidence show that the EURO emission class for which evidence was provided would lead to the collection of a lower toll rate, two brief acoustic

signals (see section 8.2.4.3.1) will prompt the driver to find a GO point of sale in order to allow the change to be made to the EURO emission class stored in the GO-Box. If the signal is ignored and no GO point of sale is found, the GO-Box will be intentionally deactivated. The driver will be alerted to this deactivation by four brief acoustic signals (see section 8.2.4.3.2).

- b) If the documents submitted as evidence show that the EURO emission class for which evidence was provided would lead to the collection of a higher toll rate, the GO-Box will, without prior signalling with two short acoustic tones (see point 8.2.4.3.1), be intentionally deactivated immediately in order to allow the change to be made to the EURO emission class stored in the GO box. The driver will be alerted to this deactivation by four brief acoustic signals (see section 8.2.4.3.2). The EURO emission class will be entered automatically the next time a GO point of sale is visited.
- c) if the documents submitted as evidence show that the EURO emission class for which evidence was provided does indeed fall in each case in the same toll rate groups as the actual EURO emission class (wrongly) entered in the GO-Box, then section 5.2.2.1.3 c) shall apply accordingly.

If a customer submits documents for verification in advance and does not request the entry of the correct EURO emission class in the GO-Box at the GO point of sale within a reasonable period of time, ASFINAG is entitled to request that the customer re-submits the documents. The registered owner or a designated third party will be informed about the obligation to re-submit documents for verification at the GO point of sale with a customer receipt in German and, where available, in the national language of the country in which the vehicle is registered. If a customer receipt is not available in that language, it will be issued in English.

5.2.3 Documents that are suitable for proving the EURO emission class of a vehicle

The following documents are examples of documents that can be submitted as evidence by the registered owner:

- 1 The vehicle registration documents (in accordance with Motor Traffic Act 1967, BGBl. No. 267/1967 as amended) or a vehicle document of the same value, as long as this document was issued by the appropriate authority in the state where the vehicle was registered.
- 2 A COP document (Conformity of Production), as long as this document was issued by the appropriate authority in the state where the vehicle was registered.
- 3 A CEMT certificate of compliance with the technical and safety standards of the vehicle (hereinafter referred to as 'CEMT certificate' for short), as long as this certificate was issued by the appropriate authority in the state where the vehicle was registered.
- 4 A Certificate of Conformity (COC) in accordance with Appendix IX of Directive 2007/46/EC.
- 5 A document of confirmation from the vehicle manufacturer in those cases where evidence of the requested EURO emission class cannot be provided using documents 1 to 4 listed above, as long as this letter of confirmation was issued either by the vehicle manufacturer or by a party expressly authorized to do so by the vehicle manufacturer. Evidence that the letter is written by the manufacturer or evidence of the authorisation given to another party to write the letter of confirmation on behalf of the vehicle manufacturer must also be provided.

Moreover, in the case of documents 2 to 5, a copy of the vehicle registration document (in accordance with Motor Traffic Act 1967, BGBl. No. 267/1967 as amended) or a document of the same value, as long as this document was issued by the appropriate authority in the state where the vehicle was registered, must also be submitted with the other documents.

The decision regarding the EURO emission class to be entered in the system is made on the basis of

- the documents submitted as evidence,
- the suitability of the documents submitted as evidence, and
- any information or evidence obtained independently by ASFINAG from third parties.

No evidence of a particle filter need be provided as this has no bearing on the toll rate.

5.3 Distribution channels

Users can register with the toll system and acquire GO-Boxes through the following distribution channels. Registration with the toll system is possible at a GO point of sale or at a GO vending machine. In those cases where no GO point of sale is available, users are obliged to use an existing GO vending machine, which are available nationwide. Not all means of payment are accepted when registering for the post-pay procedure at GO vending machines. For more information, please refer to appendix 2.

- GO points of sale, which are specially marked (see the list of GO points of sale and GO vending machines, which is available at www.go-maut.at);
- GO vending machines: these machines are freely accessible at numerous GO points of sale (see the list of GO points of sale and GO vending machines, which is available at www.go-maut.at).

Shield covers for GO-Boxes are available from GO points of sale.

GO points of sale are marked with the following signs (see complete illustration in appendix 5):



Illustration 20

5.4 Processing fee

When users register with the toll system, a non-refundable processing fee for system access (toll system registration) of € 5.00 (incl. 20 % VAT) is charged for every GO-Box issued.

5.5 Payment procedures

5.5.1. General information

The toll can either be paid by settling an account after the toll has been accrued (the post-pay procedure) or by deducting the toll from a previously purchased toll credit (pre-pay procedure). The preferred payment procedure must be indicated at the time of toll system registration and can (just like the methods and means of payment) subsequently be changed at GO points of sale upon presentation of the GO-Box and a valid means of payment.

Information regarding the methods and means of payment that are accepted for the post-pay and pre-pay procedures can be found in appendix 2. This information is also available on the Internet at www.asfinag.at, from the ASFINAG SERVICE CENTER, and at all GO points of sale.

A paper reprint of the collective invoices issued by ASFINAG for the current year and the immediately preceding calendar year can be obtained on request from the ASFINAG SERVICE CENTER for a fee of € 5.00 (including 20 % VAT) per collective invoice.

5.5.2. About the post-pay procedure

For the post-pay procedure, the toll road section rates levied for driving a vehicle that is liable for the toll on the toll road network are added up and combined to produce a daily charge. This charge is then collected using the appropriate method or means of payment.

If a card being used for the post-pay procedure has to be replaced/extended or exchanged as a result of theft, loss or expiry, toll transactions can also be charged to the new petrol card or credit card. ASFINAG is informed of the exchange or renewal/extension of the validity of the card by the card issuer.

If a card is cancelled by a card issuer, the toll cannot be paid (see section 8.2.4.3.2). If, in this case, the driver does not avail of the option of retroactively paying the toll (see section 7.1), he or she commits a toll evasion offence (see section 10).

5.5.3. About the pre-pay procedure

The GO-Box for the pre-pay procedure must immediately be charged with a toll credit of at least € 75.00 (including 20 % VAT) once it has been issued to the customer. This also applies to any subsequent charging process (toll credit top-up). The toll credit top-up is limited to a maximum € 500.00 (including 20 % VAT) per GO-Box.

Every time the toll road network is used, the appropriate toll rate for the toll road section that has been used is deducted from the toll credit balance. If the toll credit balance in the GO-Box is too low to pay the toll levied when the vehicle passes a toll collection point, no toll is collected (either in part or in total). The driver is notified by an acoustic signal, which sounds as the vehicle passes the toll collection point, that no toll has been collected (see section 8.2.4.3.2). If, in this case, the driver does not avail of the option of retroactively paying the toll (see section 7.1), he or she commits a toll evasion offence (see section 10).

5.6 Data storage

5.6.1. General information

When a user registers with the toll system (system registration), the following data is stored:

- Country (state) where the vehicle that is liable for the toll is registered

- Registration number of the vehicle that is liable for the toll and the validity of a temporary registration number (optional), details of the motor trader
- Vehicle type (truck and bus, whereby special purpose vehicles are subsumed under the vehicle type 'truck' and motorcaravans under the vehicle type 'bus').
- Base category (2, 3 or 4)
- Entered EURO emission class
- Method and means of payment (including expiry dates)
- GO-Box identification number (GO-Box number)
- Personal Account Number (PAN for short)
- First name, surname or company name of the registered owner of the vehicle (optional for the pre-pay procedure)
- Address of the registered owner (optional for the pre-pay procedure)
- Petrol, debit or credit card number (depending on the selected means of payment)
- Telephone number (optional)
- Fax number
- E-mail address (optional).

ASFINAG Maut Service GmbH is authorized to store the above-mentioned data and any other data voluntarily provided.

5.6.2. Obligation to inform ASFINAG immediately of changes in the data to be stored in accordance with section 5.6.1

The driver and the registered owner are obliged to inform ASFINAG Maut Service GmbH immediately of any changes to the stored data as soon as such a change occurs. Failure to do so means that the driver and the registered owner bear sole responsibility for all negative consequences resulting from a failure to provide this information. In particular, the driver is obliged to request the entry of any change in the vehicle registration number and EURO emission class in the GO-Box. Failure to do so may result in the driver committing a toll evasion offence in accordance with section 10.

In the event of a change in the GO-Box identification number, the vehicle registration number, or the EURO emission class, the driver will be given a new vehicle declaration at the GO point of sale, whereby the old vehicle declaration automatically becomes invalid. In this case, evidence must once again be provided in accordance with Section 5.2 or, in the case of a vehicle with a motor trader registration number, in accordance with section 5.6.6.4.

Changes that are not properly made may lead to incorrect toll payment, which constitutes a toll evasion offence (see section 10).

Vehicle data (such as the vehicle's registration number) can only be changed when the GO-Box and the vehicle registration documents are presented at a GO point of sale. In order to change the pay procedure (i.e. from post-pay to pre-pay, or from pre-pay to post-pay), the GO-Box and a valid means of payment must be presented at a GO point of sale. In both cases, the new, amended data will be stored in the GO-Box.

The vehicle registration number and the PAN are all that are required to change data relating to the registered owner. This data can be changed by calling the ASFINAG SERVICE CENTER.

The data given in an application for exemption in accordance with section 3.3.2 is stored upon submission of such an application.

ASFINAG Maut Service GmbH is authorized to correct and complete of its own accord the data stored in accordance with section 5.6.1. This is most particularly the case in those situations where the driver and the registered owner do not meet their obligation to make changes to the

data to be stored immediately. The customers' right to demand the correction and completion of data remains unaffected.

The stored data is deleted as soon as and as long as it is no longer required to collect the toll, charge costs, allow for processing, deal with complaints, or fulfil any other legal obligations.

5.6.3. SALE of a vehicle

Within the meaning of Tolling Regulations Part B, any change in the registered ownership of a vehicle that is liable for the toll constitutes a 'SALE'.

5.6.3.1 SALE of a vehicle without a registration number and without a GO-Box

Registered owners who SELL vehicles for which GO-Boxes have been issued are obliged: either to deregister from the system and return the GO-Box in accordance with section 5.7.4, or to request a change in the stored data in accordance with section 5.6.1 before the GO-Box is used in a different vehicle that is liable for the toll.

Failure to do so means that the registered owner shall be solely responsible for the settlement and payment of future toll transactions.

Before using the toll road network for the first time, the BUYER of the vehicle is obliged to re-register with the toll system by providing all the data outlined in section 5.6.1.

5.6.3.2 SALE of a vehicle with a registration number and without a GO-Box

Registered owners that SELL vehicles for which GO-Boxes have been issued are obliged:

- either to deregister from the system and return the GO-Box in accordance with section 5.7.4, or
- to earmark the GO-Box for a termination of the contract by calling the ASFINAG SERVICE CENTER. Before using the GO-Box in a different vehicle that is liable for the toll for the first time, the earmarking of the GO-Box for a termination of the contract must be reversed by calling the ASFINAG SERVICE CENTER and requesting an amendment of the data stored for that GO-Box in accordance with section 5.6.1 at a GO point of sale.

Failure to do so means that the registered owner shall be solely responsible for the settlement and payment of future toll transactions.

Before using the toll road network for the first time, the BUYER of the vehicle is obliged to re-register with the toll system by providing all the data outlined in section 5.6.1. Before this new GO-Box is issued, the BUYER must provide the new data in accordance with section 5.6.1 to be stored and pay a provisional administrative fee in accordance with section 5.7.2. This administrative fee will be refunded by ASFINAG Maut Service GmbH upon presentation of the relevant CONTRACT OF SALE.

5.6.3.3 SALE of a vehicle without a registration number and with a GO-Box

Registered owners who SELL vehicles without a registration number but with a GO-Box are obliged to request the amendment of the stored data in accordance with section 5.6.1. Failure to do so will mean that the registered owner shall be solely responsible for the settlement and payment of future toll transactions.

The BUYER must inform ASFINAG Maut Service GmbH immediately in writing that he or she has taken possession of the GO-Box by providing the GO-Box identification number and the vehicle's registration number, whereby a copy of the vehicle registration document must be appended to this letter.

If the BUYER fails to inform ASFINAG Maut Service GmbH of this change in ownership, he or she shall be solely responsible for not receiving a collective invoice with the relevant company data and that he or she will not be able to call up an itemized toll information sheet for the purchased vehicle using the self care access data (i.e. the user name and password provided by ASFINAG Maut Service GmbH).

Any remaining toll credit in a pre-pay GO-Box and any unpaid tolls in accordance with section 7.3, retroactive billing, are automatically transferred to the buyer when the vehicle is sold together with the GO-Box. This is why it is the sole responsibility of the registered owner and the BUYER to reach agreement on such matters.

If the contract is terminated, any remaining credit will be credited to the means of payment that was used to charge the GO-Box (top-up).

5.6.3.4 SALE of a vehicle with registration number and GO-Box

Registered owners who SELL vehicles with a registration number and with a GO-Box are obliged to request the immediate amendment of the stored data in accordance with section 5.6.1. Failure to do so will mean that the registered owner shall be solely responsible for the settlement and payment of future toll transactions.

The BUYER must inform ASFINAG Maut Service GmbH immediately in writing that he or she has taken possession of the GO-Box by providing the GO-Box identification number and the vehicle's registration number, whereby a copy of the vehicle registration document must be appended to this letter.

If the BUYER fails to inform ASFINAG Maut Service GmbH of this change in ownership, he or she shall be solely responsible for not receiving a collective invoice with the relevant company data and that he or she will not be able to call up an itemized toll information sheet for the purchased vehicle using the SelfCare access data (i.e. the user name and password provided by ASFINAG Maut Service GmbH).

Any remaining toll credit in a pre-pay GO-Box and any unpaid tolls in accordance with section 7.3, retroactive billing, are automatically transferred to the BUYER when the vehicle is SOLD together with the GO-Box. This is why it is the sole responsibility of the registered owner and the BUYER to reach agreement on such matters.

If the contract is terminated, any remaining credit will be credited to the means of payment that was used to top up the GO-Box credit.

5.6.4. Vehicle RENTAL

Within the meaning of Tolling Regulations Part B, any temporary granting of the right of use of a vehicle that is liable for the toll that does not involve a change in the registered owner of the vehicle that is liable for the toll constitutes 'RENTAL'.

5.6.4.1 RENTAL of a vehicle without a GO-Box

In cases where the rented vehicle has not been validly registered with the system, the RENTER must register with the toll system in accordance with section 5.

In cases where the rented vehicle has already been registered with the system, but the RENTER has not been given the GO-Box, the RENTER is obliged to register with the system in accordance with section 5. Once he or she has done so, the GO-Box that was previously registered for this vehicle's registration number will be deactivated. Before the GO-Box is issued, the RENTER must provide the new data to be stored in accordance with section 5.6.1 and pay a

provisional administrative fee in accordance with section 5.7.2. This administrative fee will be refunded by ASFINAG Maut Service GmbH upon presentation of the relevant rental agreement.

At the end of the period of rental, the RENTER is obliged to

- either deregister from the system and return the GO-Box in accordance with section 5.7.4, or
- to earmark the GO-Box for a termination of the contract by calling the ASFINAG SERVICE CENTER. Before using the GO-Box in a different vehicle that is liable for the toll for the first time, the earmarking of the GO-Box for a termination of the contract must be reversed by calling the ASFINAG SERVICE CENTER and the data stored for that GO-Box must be amended in accordance with section 5.6.1 at a GO point of sale.

Failure to do so means that the RENTER shall be solely responsible for the settlement and payment of future toll transactions.

5.6.4.2 RENTAL of a vehicle with GO-Box

Before using the toll road network for the first time, the RENTER is obliged to call the ASFINAG SERVICE CENTER, on the INTERNET at www.go-maut.at, or at any GO point of sale and provide the data required in section 5.6.1, especially a valid means of payment and the new billing data (in particular the name of the company and the invoice address).

At the end of the period of rental, the RENTER is also obliged to request that the aforementioned charging data and means of payment are deleted from the system by calling the ASFINAG SERVICE CENTER, on the INTERNET at www.go-maut.at, or at any GO point of sale. Failure to do so will mean that the RENTER shall be solely responsible for the settlement and payment of future toll transactions.

The provision of itemized toll information sheets in accordance with section 6 for the period of rental must be requested in advance by calling the ASFINAG SERVICE CENTER and providing evidence of the start and end of the rental period, whereby the RENTER must provide both the registration number of the rented vehicle, his or her invoice address, and any reference number for the collective invoice.

Any remaining toll credit in a pre-pay GO-Box and any unpaid tolls in accordance with section 7.3, retroactive billing, are automatically transferred to the new RENTER or the RENTING COMPANY when the vehicle is RENTED together with the GO-Box. This is why it is the sole responsibility of the RENTER, the new RENTER, and the RENTING COMPANY to reach agreement on such matters.

If the contract is terminated, any remaining credit will be credited to the means of payment that was used to top up the GO-Box credit.

5.6.5. Transferable license plates (Wechselkennzeichen)

In accordance BStMG, the following rule applies to vehicles to which a single license plate number has been allocated (transferable license plates, Wechselkennzeichen):

If these vehicles cannot be allocated to the same toll rate groups, all of the vehicles to which the transferable license plate was allocated are liable for the toll rate of the toll rate groups for which the highest toll rate has been specified.

For this reason, when entering a EURO emission class at a GO point of sale (see section 5.2), the higher toll rate has to be allocated, if the emission class does not in each case belong to the same toll rate groups. This EURO emission class will be entered for the transferable license plate in general and applies to all vehicles using that transferable license plate. Moreover, all

evidence relating to all vehicles for which the transferable license plate is used must be submitted to ASFINAG for verification (see section 5.2).

5.6.6. Test drivers and motor trader trips

5.6.6.1 General remarks

Companies that carry out test drives and/or complete trips in the course of their business as motor traders and who have been issued with one or more test drive registration numbers and/or motor trader registration numbers (trade plates) or equivalent foreign registration numbers by an authority (hereinafter jointly referred to as 'motor traders') may avail of the following alternative special provisions.

In amendment of section 5.2, the motor trader may specify to ASFINAG one or more test drive registration numbers or motor trader registration numbers that the company has selected for registration with the toll system (see section 5.6.6.2). Test drive registration numbers and/or motor trader registration numbers shall hereinafter jointly be referred to as 'motor trader registration numbers'.

On the basis of the written registration, ASFINAG shall enter the registered motor trader registration numbers and the EURO emission classes for these registration numbers for which evidence has been provided as motor trader registration numbers in the central system.

The EURO emission class of the motor trader registration number must only be declared separately at a GO point of sale if a EURO emission class has not yet been declared for the motor trader registration number and no evidence of the EURO emission class has been provided (see section 5.6.6.3). In this case, the registration form and the vehicle registration document must be submitted within 28 days of the declaration. Until such time as the registration is successfully completed, the provisions in section 5.2 shall apply.

For test drives and motor trader trips, the general purpose of verifying the vehicle declaration before the start of the journey (see section 8.2.4.1 and section 8.2.4.2) is to ensure that

- 1) the EURO emission class entered in the correctly installed GO-Box in the vehicle corresponds in each case to the same toll rate groups as the EURO emission class of the relevant vehicle that is being used for the test drive and motor trader trip and that
- 2) the registration number that corresponds to the registration number that has been entered in the GO-Box is properly attached to the vehicle.

If the EURO emission class and/or the registration number do not correspond to the data entered in the GO-Box, the driver must ensure that the data is corrected (see section 5.6.2).

5.6.6.2 Registration and de-registration

The application form provided by ASFINAG must be used to register registration numbers as motor trader registration numbers.

The application form, which is available in a variety of languages,

- can be downloaded from
 - the SelfCare portal (www.go-maut.at) or
 - www.asfinag.at;
- can be requested from the ASFINAG SERVICE CENTER.

The application form must be filled out, signed, and submitted to ASFINAG together with a copy of the vehicle registration document. The motor trader may submit the application form in one of a number of different ways outlined in section 5.2.2.1. It is not possible to submit the application

directly from a GO point of sale. The motor trader must be available to answer any questions ASFINAG might have.

Once ASFINAG has verified the application and if the outcome of the verification is positive, the indicated registration number shall be entered in the central system as a motor trader registration number and the person who submitted the application shall be informed that both the application and the registration have been successful.

If the information provided by the person submitting the application is insufficient or if no information is provided or if there are other reasons that prevent a successful registration, the motor trader cannot be registered and the general provisions outlined in section 5.2 apply.

Applications to de-register motor traders must be made in writing. After de-registration, the general provisions outlined in section 5.2 apply.

5.6.6.3 Declaration of the relevant EURO emission class

As far as the obligation to make a declaration is concerned, ASFINAG differentiates between the following cases:

- a) *The relevant EURO emission class for the respective motor trader registration number was already entered in the central system before the motor trader was registered*

If a EURO emission class has already been correctly declared for the registered motor trader registration number in accordance with section 5.2 before the motor trader was registered, this EURO emission class shall be used for that motor trader registration number. If a different EURO emission class has to be entered for this motor trader registration number, the data must be amended in accordance with c).

- b) *The EURO emission class was not entered for the relevant motor trader registration number before the motor trader was registered*

Section 5.2.1 applies with the stipulation that in addition to a verification of the registration, evidence must be verified periodically (see section 5.6.6.4). Regardless of the registration, a specific EURO emission class must be requested for the motor trader registration number at the GO point of sale. At the GO point of sale, a vehicle declaration and an information receipt indicating the obligation to provide evidence periodically will be given. The information receipt will be given in German and, where available, in the national language of the country in which the vehicle is registered. If an information receipt is not available in that language, an information receipt will be given in English.

- c) *Amendment of a EURO emission class that has already been entered for a motor trader registration number*

In this case, section 5.6.2 applies.

5.6.6.4 Periodical provision of evidence

5.6.6.4.1 *General remarks*

As part of the registration process, a specific EURO emission class is allocated to the respective motor trader registration number on the basis of the vehicle registration document. Evidence of the legitimacy of the entered EURO emission class (i.e. the entry of a EURO emission class to each toll rate group that corresponds to that of the respective vehicle that is used for the test drive and motor trader trip) must subsequently be provided periodically. Periods are defined as

follows: the period of time between the 1st and the 15th of every calendar month or the period of time between the 16th and the last day of a calendar month.

The respective test drive and motor trader trip for which evidence must be provided is defined as the trip during which a specific vehicle is transferred to its respective place of destination.

For the first period of a calendar month (i.e. from the 1st to the 15th of the month), completed test drives and motor trader trips must be listed and evidence of these trips must be provided. Both the list and the evidence must be submitted to ASFINAG by the last day of the respective calendar month (hereinafter referred to as the 'submission deadline'). For the second period of a calendar month (i.e. from the 16th to the last day of the month), completed test drives and motor trader trips must be listed and evidence of these trips must be provided. Both the list and the evidence must be submitted to ASFINAG by the 15th day of the following calendar month (hereinafter referred to as the 'submission deadline').

If the requested EURO emission class is allocated to the in each case highest toll rate group, it is not necessary to list the trips and provide evidence of them.

If vehicles with different EURO emission classes, which were allocated to different toll rate groups, were used for consecutive test drives and motor trader trips, then, before the journey is started:

- either the GO-Boxes (that were previously carried in the vehicle) and the registration number must be changed or
- the data must be changed (see section 5.6.2).

In any case, the driver must check the vehicle declaration before the start of every test drive and motor trader trip (see section 8.2.4.1 and section 8.2.4.2) to ensure that

- a EURO emission class has been stored in the correctly installed GO-Box in the vehicle that corresponds to the same toll rate groups as the EURO emission class of the relevant vehicle that is being used for the test drive and motor trader trip and that
- the registration number that corresponds to the registration number entered in the GO-Box has been properly attached to the vehicle.

If several registration numbers and GO-Boxes are carried in the vehicle for subsequent test drives and motor trader trips, the driver must ensure that those GO-Boxes that are carried in the vehicle without actually being used are deactivated using the correct cover (see section 3.1.2 and section 8.2.4.1). If the GO-Boxes that are carried in the vehicle without actually being used are not deactivated in this way, toll transactions will be triggered or tolls collected automatically. If this happens, the collected tolls will not be refunded. It should be noted that in this context, it is the responsibility of the driver to take appropriate action in accordance with section 8.2.4.1 and section 8.2.4.2.

5.6.6.4.2 *Evidence*

All evidence required for the periodical provision of evidence and the lists must be submitted to ASFINAG by the motor trader by uploading the relevant documents via the SelfCare portal.

5.6.6.4.3 *Verification of evidence*

ASFINAG shall verify the legitimacy of the EURO emission class entered for every test drive and motor trader trip (see section 5.6.6.4.1).

As far as the verification of evidence is concerned, ASFINAG differentiates between the following cases:

- a) *Documents for the right EURO emission class are submitted as evidence before the submission deadline*
In this case, the periodical evidence is considered to have been correctly provided.
- b) *Documents for the wrong EURO emission class are submitted as evidence before the submission deadline.*
In this case, a toll evasion offence in accordance with section 10 may have been committed for the relevant test drive and motor trader trip.
- c) *Documents are not submitted as evidence before the submission deadline*
In this case, a toll evasion offence in accordance with section 10 may have been committed for the relevant test drive and motor trader trip.
- d) *No documents were submitted as evidence.*
In this case, a toll evasion offence in accordance with section 10 may have been committed for the relevant test drive and motor trader trip.

5.7 Provisions relating to the GO-Box

5.7.1. General information

There are two different types of GO-Box: the GO-Box and the Split GO-Box (both called 'GO-Box' for short), whereby GO-Boxes (not Split GO-Boxes) must be used in all vehicles that are liable for the toll and either do not have a metallized windscreen or have a metallized windscreen and a corresponding DSRC window. If the vehicle that is liable for the toll has metallized windscreens but no corresponding DSRC window, the customer must without exception use a Split GO-Box. Split GO-Boxes are also available in GO points of sale.

ASFINAG Maut Service GmbH issues the customer with the GO-Box or the Split GO-Box for use exclusively with the registration number of the vehicle that is liable for the toll and has been registered with the toll system. GO-Boxes are issued free of charge, for a limited period that lasts until the toll system is completely abolished, and for the sole purpose of using the GO-Box to pay the distance-related toll. This means that the customer and ASFINAG Maut Service GmbH conclude a contract of loan for use within the meaning of sections 971 onward of the General Civil Code (ABGB). At the end of the contractual relationship, the customer must therefore return the GO-Box or Split GO-Box to ASFINAG Maut Service GmbH (see section 5.6.4).

The customer or a third party attributable to the customer is responsible for looking after the GO-BOX and handling it with due care for the duration of the loan period. Above all, it is not permissible to change the GO-BOX in any way, for example by opening it, writing on it, changing the colour of its housing, and damaging or rendering illegible either the barcode on the back of the GO-BOX and/or the GO-BOX identification number. In cases where the GO-BOX is damaged either due to intent or gross negligence—in particular in those cases mentioned above—the customer is obliged to pay the administrative fee outlined in section 5.7.2. The right to assert further claims for damages is reserved.

Claims for damages against ASFINAG and ASFINAG Maut Service GmbH shall be rejected unless caused intentionally or by gross negligence.

5.7.2. GO-Box: period of validity, guarantee, exchange, bearing of costs, and recall

5.7.2.1 Maximum period of validity of the GO-Box

Depending on the type of contract in question, the maximum periods of GO-Box validity are as follows: for the post-pay procedure, five years starting with the date the GO-Box is issued to the customer, and for the pre-pay procedure, two years starting with the date the toll credit was last topped up. ASFINAG Maut Service GmbH is entitled to either recall a GO-Box with a view to replacing it or to deactivate a GO-Box before the end of its period of validity even if the GO-Box is being correctly used.

5.7.2.2 Guarantee

ASFINAG Maut Service GmbH grants the customer a five-year full operability guarantee from the date the GO-Box is issued to the customer. During this period, ASFINAG Maut Service GmbH will rectify any functional faults and ensure that the GO-Box functions properly by exchanging the GO-Box. During the guarantee period, the GO-Box shall be exchanged free of charge as long as the functional faults were not caused by the negligence of the customer or a third party attributable to the customer. In cases of doubt, the customer is obliged to pay the administrative fee (see below). If ASFINAG Maut Service GmbH is subsequently found to be responsible for the fault, this fee will be refunded if and in so far as the customer has submitted a written application (for a refund) to ASFINAG Maut Service GmbH. All claims are satisfied with the exchange of the GO-Box. After the end of the guarantee period, the customer is obliged to return the GO-Box (see section 5.7.4) and to register with the system again (see section 5.1). When re-registering with the system, the customer must pay the necessary processing fee in order to access the system (see section 5.4).

If, however, the customer or a third party attributable to the customer is responsible for the fault, ASFINAG Maut Service GmbH is entitled to charge the customer the following administrative fee (excluding VAT), depending on the amount of time that has passed since the GO-Box was issued to the customer.

| Time elapsed since issue | For a GO-Box | For a Split GO-Box |
|---------------------------------|---------------------|---------------------------|
| During the first year: | € 60.00 | € 200.00 |
| During the second year: | € 48.00 | € 160.00 |
| During the third year: | € 36.00 | € 120.00 |
| During the fourth year: | € 24.00 | € 80.00 |
| During the fifth year: | € 12.00 | € 40.00 |

5.7.2.3 GO-Box recall

The GO-Box will automatically be recalled before the period of validity expires so that it may be replaced. If this recall notification is ignored, the GO-Box will automatically be deactivated (see section 8.2.4.3.2).

5.7.2.4 Deactivation of the GO-Box

ASFINAG Maut Service GmbH is entitled to deactivate the GO-Box in the event of technical faults or if it discovers irregularities in the collection of tolls. Such irregularities in the collection of tolls, which entitle ASFINAG to deactivate the GO-Box, include cases where tolls that have been accrued by a driver cannot be collected properly. In such cases, the GO-Box sounds a warning signal as an indication that the GO-Box has been deactivated when the vehicle passes a toll collection point (see section 8.2.4.3.2).

5.7.2.5 Replacement

Defective GO-Boxes can only be replaced at a GO point of sale upon presentation of the vehicle registration document.

5.7.2.6 Legal consequences of deactivation or the use of the toll road network after the expiry of the period of validity

Once the period of validity has expired, or once a GO-Box has been deactivated, no more toll transactions can be made using that GO-Box. If the driver uses the toll road network despite the expiry of the period of validity or the deactivation of the GO-Box without availing of the option of retroactively paying the toll (see section 7.1), he or she shall be considered to have committed a toll evasion offence (see section 10).

5.7.3. Theft, loss, and deactivation of the GO-Box

The customer bears sole responsibility for the safekeeping of the GO-Box. In the event of the theft or loss of the GO-Box (hereinafter referred to as 'LOSS' for short), the customer must immediately inform the ASFINAG SERVICE CENTER, giving the relevant GO-Box number and PAN. The GO-Box will be deactivated once its LOSS has been reported. For the LOSS of the GO-Box, an administrative fee defined in section 5.7.2 must be paid before the new GO-Box (also known as a 'replacement GO-Box') is issued and at the latest within one month of reporting the LOSS. No other costs are accrued for the acquisition of a new GO-Box. The customer's obligations in the event of the theft or loss of petrol cards, credit cards, and debit cards depend on the provisions of the respective card issuer (however, see also section 5.5.2).

A LOST GO-Box that is retrieved at a later date can only be reactivated by the ASFINAG SERVICE CENTER upon presentation of the relevant GO-Box number and PAN before a new GO-Box has been issued.

If a LOST GO-Box is retrieved after a replacement GO-Box has been issued, the retrieved (old) GO-Box must be returned in accordance with section 5.7.4. Any toll credit in the old GO-Box will already have been transferred to the replacement GO-Box before the latter was issued.

5.7.4. Deregistration, returning the GO-Box, and the lapse of toll credit

The customer deregisters from the toll system by returning the GO-Box. If the GO-Box cannot be returned as a result of theft or loss, the customer must deregister by writing to ASFINAG Maut Service GmbH (see section 5.7.3).

The GO-Box must be returned in person at a GO point of sale or by sending it to ASFINAG Maut Service GmbH (see information in section 13) together with the customer's name, address, and bank account details. In cases where a GO-Box contract for the pre-pay procedure cannot be terminated directly at the GO point of sale, the appropriate GO-Box must be sent to ASFINAG Maut Service GmbH. The provision of this data is only necessary for the pre-pay procedure. Bank account details must only be provided if both a refund receipt and a credit receipt are printed. This happens in those cases where unused toll credit that was topped up using cash, Quick Chip, or any other means of payment that is no longer valid is refunded. Before sending the GO-Box, the customer must ensure that it is deactivated to avoid the triggering of toll transactions or the collection of tolls during transportation. To deactivate the GO-Box, the customer must call the ASFINAG SERVICE CENTER and provide the PAN and the registration number. If the customer does not arrange for deactivation of the GO-Box, any toll transactions triggered or tolls collected during transportation will not be refunded.

If there is still some unused toll credit when the GO-Box is returned (only applies to the pre-pay procedure), this sum will be refunded, whereby any unpaid tolls will be invoiced separately in accordance with section 7.3, retroactive billing.

If the unused toll credit is lower than the last amount with which the GO-Box was charged, the amount will be refunded using the means of payment that was last used to charge the GO-Box, i.e. either in cash (whereby payment using Maestro or Quick-Chip is considered the same as paying in cash) or by crediting the sum to a petrol or credit card. If the unused toll credit is greater than the last amount with which the GO-Box was charged, the last amount with which the GO-Box was charged will be refunded using the means of payment that was last used to charge the GO-Box. The difference between the toll credit and the last amount with which the GO-Box was charged, on the other hand, will be refunded using the means of payment that was used to charge the GO-Box on the last but one occasion. This refund procedure, which is necessary as a result of the current terms and conditions of use for credit cards and petrol card, will be repeated in this manner until such time as the entire toll credit has been refunded.

If a GO-Box for the pre-pay procedure is sent by post to ASFINAG Maut Service GmbH, any unused toll credit is only credited to the customer's account if name, address, and bank account details including name of the account holder, IBAN, and BIC (if the GO-Box toll credit was topped up using cash, Maestro, or Quick Chip) are provided.

Refunds are only credited to the customer's bank account when the unused toll credit exceeds € 5.00.

Toll credit (for the pre-pay procedure) is only valid for two years from the date of the last charging procedure (top-up). After this period, it is no longer possible to collect tolls. Two months before the end of this two-year period, the GO-Box sounds a warning signal when the vehicle passes a toll collection point (see section 8.2.4.3.1). Toll credit lapses five years after the last charging procedure (in other words, three years after the end of the period of validity) unless more toll credit is charged within this time or the GO-Box is returned. If the GO-Box is charged with new toll credit within this period, the total credit in the GO-Box (i.e. the old toll credit plus the newly charged toll credit) becomes valid.

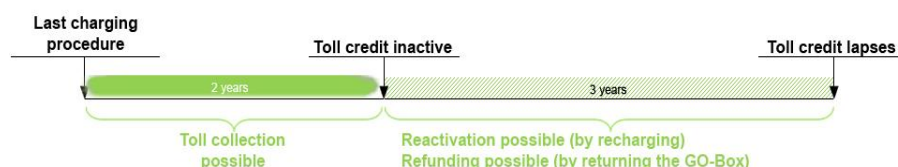

5.7.5. Transportation of GO-Boxes without the obligation to pay the mandatory toll

Customers can obtain shield covers for GO-Boxes at GO points of sale (see section 5.3). For those cases where a GO-Box is carried in a vehicle that is not liable to pay the distance-related toll (e.g. when a GO-Box is being transported in a passenger car), the GO-Box in question must be deactivated by ensuring that the cover is properly closed around the GO-Box. To this end, the cover must be wrapped at least three times around the GO-Box and subsequently closed securely using staples or adhesive tape.

If the GO-Box is not deactivated, toll transactions will be triggered or tolls collected automatically. If this happens, the collected tolls will not be refunded.

6 ITEMIZED TOLL INFORMATION SHEETS AND COLLECTIVE INVOICE STATEMENTS

6.1 Itemized toll information sheets

Itemized toll information sheets that list all automatic toll transactions and retroactively billed toll sections in the post-pay procedure can be obtained (backdated one year) either in printed form from the ASFINAG SERVICE CENTER (on request only) for a fee of € 5.00 (including 20% VAT) per itemized toll information sheet and vehicle, or free of charge on the Internet at www.go-maut.at (SelfCare Portal). An itemized toll information sheet, as described above, can also be viewed using the ASFINAG app “Unterwegs”, although this is limited to the period of the current calendar and the month immediately preceding it.

Itemized toll information sheets listing automatic toll transactions and retroactively billed toll sections for periods outside this one-year limit will only be supplied by the ASFINAG SERVICE CENTER upon payment of a fee that reimburses ASFINAG for the actual internal costs generated by the specific request.

An itemized toll information sheet is not an invoice; it is for information purposes only. No responsibility or liability will therefore be assumed for the timeliness, correctness, and completeness of the information contained in the itemized toll information sheets.

6.2 Collective invoice statements

If payment is made by credit card, ASFINAG is not aware of the amounts actually paid and cannot, therefore, issue a confirmation of the payment balance. Instead, it can only provide a collective invoice statement that lists the toll charges transmitted to the credit card institute for invoicing purposes. All requests should be made to the ASFINAG SERVICE CENTER.

A collective invoice statement for the six-calendar months preceding the request will be issued for a fee of € 5.00 (including 20% VAT) per customer number.

Collective invoice statements for periods outside this six-month limit will only be supplied by the ASFINAG SERVICE CENTER upon payment of a fee that reimburses ASFINAG for the actual internal costs generated by the specific request.

7 RETROACTIVE TOLL PAYMENT

7.1 Retroactive payment at GO points of sale and to toll enforcement officers

Tolls that have either not been paid or only paid in part for the following reasons can be paid retroactively for vehicles that have been properly registered with the toll system and are equipped with an authorized on-board unit: technical failure of the authorized on-board unit or the toll system, an insufficient pre-pay toll credit balance, use of a cancelled means of payment, use of a GO-Box after the period of validity has ended in accordance with section 5.7.2, or the use of an incorrect (too low) category or a toll rate group that is too low. However, retroactive payment is only possible if all of the following conditions are fulfilled. Retroactive payment may only be made for the vehicle registration number for which the toll was not paid or was only paid in part.

- Retroactive payment for a toll transaction that was not correctly made (i.e. the toll was not paid at all or was only paid in part) can be made at a GO point of sale or, if the driver is apprehended (i.e. stopped), to a toll enforcement officer (see section 9) as long as the toll transaction that was not correctly made is subsequently paid within the RETROACTIVE PAYMENT ZONE.

The RETROACTIVE PAYMENT ZONE of a TOLL ENFORCEMENT OFFICER is 100 km (in both directions) on the toll road network, starting at the point where the driver was checked (i.e. the place he or she was apprehended).

The RETROACTIVE PAYMENT ZONE of a GO point of sale is 100 km (in both directions) on the toll road network, starting at the location of the GO point of sale (point of sale on the toll road network, e.g. at a motorway service area) or starting from the junction closest to the p (point of sale on a lower-ranking road, not on the toll road network).

- Retroactive payment is only permitted within five hours of the vehicle passing the first toll collection point at which the toll transaction was not correctly made (i.e. the toll was not paid at all or was only paid in part). The reference time of the toll system is used as a reference in this regard.
- GO-Box users must present the GO-Box at the nearest GO point of sale to make retroactive payment.
- The driver of the vehicle that is liable for the toll must inform personnel at the GO point of sale or, if the driver is apprehended (stopped), the toll enforcement officer of the point where the toll was not paid or was only paid in part and, when requested to do so, provide information on how he or she intends to use the toll road network in the immediate future.

The toll rate to be paid and, therefore, the amount due is calculated on the basis of the information provided by the driver (regarding the toll point where the toll was not paid or was only paid in part, the actual number of axles on the vehicles at the time the toll was not paid or was only paid in part etc.), the presentation of any evidence (e.g. tachograph), and the presentation of the GO-Box (to avoid double payments, a comparison of the toll transactions stored in the on-board unit may be made). If the amount calculated in this way is lower than € 0.10, the amount shall be rounded up to € 0.10. Retroactive payment for a EURO emission class that is lower than the actual (or actually proven) toll rate group presupposes that the driver makes known the EURO emission class that led to the difference in the sum to be paid in the form of a retroactive payment.

If the driver of the vehicle is stopped by toll enforcement officers, retroactive payment must be made immediately to these officers. In cases where the GO-Box is not permanently attached or the official registration number is not visibly attached to the vehicle (see section 8.2.4.3), this

retroactive payment cannot be made to the toll enforcement officers, but only at a GO point of sale.

In cases where the incorrectly paid toll is retroactively charged automatically in accordance with section 7.3 and in conjunction with section 8.2.4.3.3, retroactive payment is not obligatory.

7.2 Central retroactive payment in the event of use of a too low category or toll rate group

As an alternative to the procedure described in section 7.1, the driver may, if he/she sets a category or toll rate group that is too low for his/her vehicle, use the central retroactive payment procedure. This payment requires the customer to provide certain information and must take place within 96 hours of passing the first toll collection point at which the toll was not correctly paid (i.e. only partially paid).

Drivers can use the central retroactive payment procedure as long as the following data is made available by either calling the ASFINAG SERVICE CENTER or by submitting it via INTERNET:

- PAN;
- the GO-Box identification number of the GO-Box that was used at the time the toll was not correctly paid;
- the country and registration number entered in the GO-Box;
- the correct category and the correct EURO emission class;
- the date and time when the toll was not correctly paid;
- provision of a valid means of payment in accordance with section 3.1.2 of appendix 2 that can be used for central retroactive payment;
- the name and invoice address (for anonymous pre-pay customers) in cases where an anonymous pre-pay customer would like to receive an invoice.

Central retroactive payment can also be made using the ASFINAG app “Unterwegs” (only when using the post-pay procedure). In addition to selecting the vehicle concerned (registration number and registration country) with the respective GO-Box identification number, it is also necessary to enter the official category or the official EURO emission class as well as the time period (date and time) for which the central retroactive payment should be made. The payment can only be made using the post-pay payment method stored in the GO-Box. If central retroactive payment is not possible via the ASFINAG app “Unterwegs” (if, for example, the GO-Box has been exchanged in the meantime or changed to the pre-pay procedure), then it is mandatory to use a different option for the toll payment.

Central retroactive payment is by all means only an option in those cases where at least one toll transaction was only partly paid during the period of time in question.

For technical reasons, central retroactive payment can only be made once for the given toll road section and period; subsequent corrections after payment are not, therefore, possible.

The toll rate to be paid and, therefore, the amount due is calculated on the basis of the information provided by the customer to the ASFINAG SERVICE CENTER, on the INTERNET or using the ASFINAG app “Unterwegs” (the date and time when the toll was not correctly paid etc.). If the amount calculated in this way is lower than € 0.10, the amount shall be rounded up to € 0.10.

If the driver of the vehicle is stopped by toll enforcement officers, retroactive payment must be made to them.

7.3 Retroactive billing

ASFINAG has the right to bill customers automatically for tolls that have not been paid in situations complying with section 8.2.4.3.3 and in cases where ASFINAG has chosen not to erect a toll collection point on a specific toll road section (see the fourth paragraph of section 1). Retroactive billing only occurs in cases where a customer uses a road section subject to toll charging but where a toll transaction was not correctly made. The retroactively billed toll for the relevant road section subject to toll charging corresponds exactly to the toll road section rates listed in appendix 4 of the Tolling Regulations at the time the toll transaction was not made. This applies equally to retroactive billing for both the pre-pay and post-pay procedures.

The pre-pay procedure

The first time the driver makes contact with personnel at a GO point of sale after the failed toll transaction, he or she will be requested to pay the retroactively billed toll on the spot. The customer will be given a special receipt for the retroactively billed amount, which contains a detailed listing of the toll road sections for which a toll was retroactively billed. Toll credit can only be recharged, data changed, and contracts terminated once this retroactively billed toll has been paid in full. It is not permissible to offset the retroactively billed toll against any existing toll credit.

The post-pay procedure

In the post-pay procedure, retroactive billing is settled without any extra activity on the part of the customer; the retroactively billed toll is simply added to the periodical collective invoices or petrol card invoices that are sent to the customer.

8 THE DRIVER'S OBLIGATIONS

8.1 Correct installation of the GO-Box

The GO-Box shall only be installed in the authorized vehicle that is liable for the toll and carries the registration number to which the GO-Box has been registered. It has to be permanently installed in the following part (see illustration 21):

- The GO-Box must be attached to the inside of the windscreen between the centre of the vehicle and the centre of the steering wheel.
- It must be attached to that part of the windscreen that is cleaned by the windscreen wipers and in such a way that the GO-Box control key faces the interior of the vehicle.
- It must be attached at least 10 cm above the windscreen wipers when they are switched off and in the horizontal position and at least 30 cm below the upper edge of the windscreen.
- The attached GO-Box must not impede vision while driving.
- An area of the windscreen surrounding the GO-Box with a radius of 10 cm must be kept free of all objects and vehicle parts (e.g. sun shades).
- The GO-Box should not be attached to the windscreen behind a strip of tinted glass.
- The driver is also obliged to keep all objects that could impair operation of the control keys away from the GO-Box.

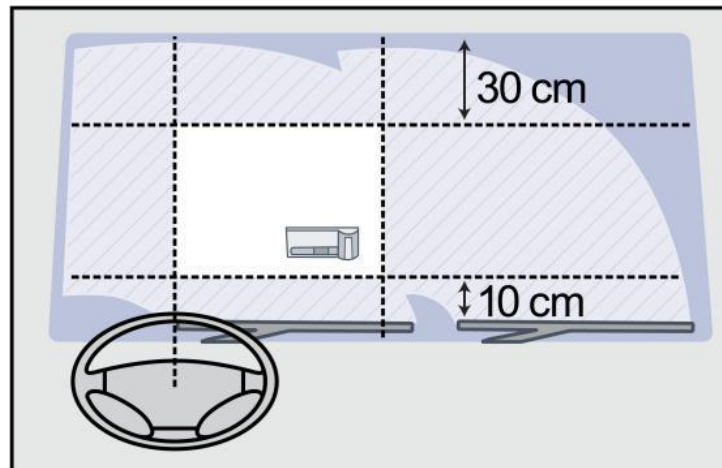

Illustration 21: the correct installation of the GO-Box

The GO-Box may not be attached in a different area without prior single-approval in written form by ASFINAG Maut Service GmbH.

Special instructions apply for the installation of a Split GO-Box. These instructions can be found in the Split GO-Box's operating manual.

8.2 Correct operation of the GO-Box

8.2.1 Parts of the GO-Box

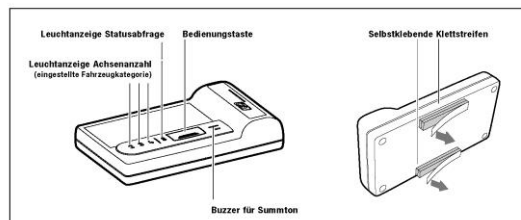

Illustration 22

8.2.2 Declaring and setting the vehicle category (not applicable for buses and motor caravans)

When the GO-Box is issued, a base category is set for the vehicle that is liable for the toll on the basis of the vehicle's number of axles (the base category constitutes the lowest category that can be manually set). The driver is obliged to check the category in accordance with section 8.2.4.2 before starting each journey.

If a trailer or a road semi-trailer is attached to the vehicle, the driver is obliged to change the vehicle category to the correct category. The actual number of axles of the towing vehicle together with the number of axles of the (semi-) trailer, regardless of the maximum gross vehicle weight of the (semi-) trailer, determines the category that is to be set. The user can increase the category by pressing the control key for longer than two seconds (the base category follows category 4 in the sequence). Once the category has been changed, the appropriate LED (category 2-4) will flash, thereby indicating the newly set category.

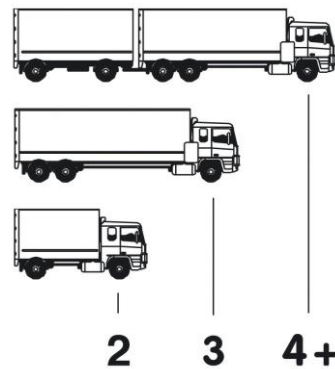

Illustration 23

If the vehicle driver mistakenly declares a higher category than the actual category for the vehicle or combination of vehicles that is liable for the toll and consequently pays/is charged the wrong toll rate, ASFINAG can refund the excess toll paid once the reasons for the mistake have been stated and corresponding evidence provided. Applications for refunds must be accompanied by the corresponding evidence and submitted within three months of the date on which the excess toll was paid. Applications should be submitted directly to ASFINAG Maut Service GmbH (see section 13).

8.2.3 Declaring and setting the vehicle category (buses and motor caravans)

When the GO-Box is issued, a base category is set on the basis of the bus or motorcaravan's number of axles (definition given in section 2(1)(28a) of the Motor Traffic Act 1967). See also the illustration in section 8.2.2. It is not necessary to change the base category because trailers attached to buses or motorcaravans are not taken into account when counting the number of axles.

8.2.4 Checking that the GO-Box is in working order

8.2.4.1 The driver's duties

In accordance with section 8(2) BStMG, drivers must check that the GO-Box is in technical working order before, during, and at the end of every trip on the toll road network and report any malfunctions or faults immediately; set the number of axles on the GO-Box; and carry any evidence outlined in section 5.2.3 that allows the allocation of the EURO emission class to a toll rate group to be checked. The driver's general obligations also include the obligation to familiarise himself/herself with the meaning of the different GO-Box acoustic signals described in section 8.2.4.3 and to act in accordance with sections 8.2.4.2 to 8.2.4.4. Furthermore, they should carry a shield cover in the vehicle that is liable for the toll (see section 3.3.3).

The driver is obliged to check the vehicle declaration he/she was given at the time the EURO emission class was declared in accordance with section 5.2 and to carry this document in the vehicle.

If the vehicle declaration is lost or damaged, it must be reprinted. This can be done at any GO point of sale or centrally from the SelfCare portal.

In the event of any changes in data that affect in particular the vehicle registration number, the entered EURO emission class, or the GO-Box identification number, the issuing of a new vehicle declaration must be requested at a GO point of sale, whereby the old vehicle declaration becomes invalid. The procedure that must be observed in this case is outlined in section 5.6.2.

8.2.4.2 Before starting the trip

Before entering the toll road network, the vehicle driver must check that the GO-Box is in technical working order (i.e. must conduct a status check) by briefly pressing the control key once (for less than two seconds) The sole purpose of conducting a status check is to make sure that the GO-Box is in technical working order. The LED that lights up during the status check does not, however, inform the driver of any existing reasons for a deactivation of the GO-Box; the driver is only alerted to the payment or the non-payment of the toll by the various acoustic signals emitted by the GO-Box (for more information on the meaning of the acoustic signals and the actions the driver must take in response to these signals, see section 8.2.4.3).

The obligation to check that the GO-Box is in working order also includes the correct category declaration and setting in accordance with section 8.2.2.

- If both the 'Status check' and 'Number of axles' LEDs briefly flash 'green' once, the GO-Box is basically in proper technical working order.
- If the 'Status check' LED briefly flashes 'red' twice and the 'Number of axles' LED briefly flashes 'green' twice, the GO-Box is in technical working order. These LEDs also indicate that the toll credit balance in accordance with the pre-pay procedure has dropped below the fixed limit (€ 30.00). The driver must ensure at his own discretion and on his own responsibility that the toll credit is recharged in time.
- If the 'Status check' LED briefly flashes 'red' four times, no tolls can be collected. In this case, the driver must go immediately to the nearest GO point of sale or refrain from driving on the toll road network.
- If the 'Status check' LED and the 'Number of axles' LEDs do not flash (no flash), the GO-Box is not in working order.

Moreover, before starting the trip, the driver must check the following on the basis of the vehicle declaration:

- that the vehicle registration number attached to the vehicle is the same as the official vehicle registration number printed on the vehicle declaration and
- the GO-Box identification number of the GO-Box in the vehicle is the same as the GO-Box identification number in the vehicle declaration.

If either or both are not the same, the driver must visit the nearest GO point of sale and request a corresponding change of the data in the GO-Box in accordance with section 5.6.2.

The difference in the toll accrued for the use of the sections of the toll road network used to reach the GO point of sale must be paid retroactively in accordance with section 7.

Failure to do so may result in the driver committing a toll evasion offence in accordance with section 10.

8.2.4.3 During the trip

For the duration of the use of the toll road network, the GO-Box must be properly and permanently attached to the windscreen of the vehicle in accordance with section 8.1.

In order to ensure that the toll can be properly collected, the driver must in accordance with section 102 KFG make sure that the official registration number of the vehicle liable for the toll is completely visible at all times during the trip and is not rendered illegible by dirt, snow, damage, or deformation.

Whenever the vehicle passes a toll collection point, the driver will hear the following acoustic signals. The driver should note the difference between acoustic signals that must be observed and those that provide information.

8.2.4.3.1 The following acoustic signals provide vehicle drivers with information:

- One brief acoustic signal: Toll payment is confirmed on the basis of the set category and the EURO emission class stored in the GO-Box.
- Two brief acoustic signals: Although payment of the toll is confirmed on the basis of the set category and the EURO emission class stored in the GO-Box, the driver must go to the nearest GO point of sale immediately.
Failure to do so can lead to the automatic deactivation of a GO-Box (see section 8.2.4.3.2).
This information signal is heard in the following cases in particular:
 - the toll credit (only applies to the pre-pay procedure) has dropped below the limit of € 30.00 (the user must ensure that the toll credit is topped up in time),
 - the toll credit will lapse within the next two months (only applies to the pre-pay procedure),
 - the period of validity of the GO-Box will expire within the next two months,
 - the data stored in the GO-Box must be changed,
 - the customer is requested to exchange the GO-Box or
 - to check the correct mounting of the GO-Box

8.2.4.3.2 The following acoustic signal must be observed by the vehicle driver:

- Four brief acoustic signals: no toll was paid
This signal is heard in the following cases in particular:
 - provisions in Tolling Regulations Part B were not observed by the customer,
 - the GO-Box was deactivated as a result of a recall so that the GO-Box can be exchanged,
 - technical faults or observed irregularities relating to toll collection, or
 - the entry of the incorrect EURO emission class.

In this case, the vehicle driver is obliged to pay the toll retroactively and in full in accordance with section 7.1. Failure to comply with this provision constitutes a toll evasion offence in accordance with section 10.

8.2.4.3.3 No acoustic signal:

If no acoustic signal sounds, no toll was paid. There is no obligation to pay the toll retroactively in accordance with section 7.1 as long as all of the following conditions are met without exception:

- The GO-Box is properly installed in accordance with section 8.1.
- The GO-Box was at the time of passing a toll collection point registered with the system for the post-pay procedure using an authorized means of payment or was charged with sufficient toll credit for the pre-pay procedure.
- The user checked that the GO-Box was in proper working order in accordance with sections 8.2.4.2 and 8.2.4.4.
- The category of the vehicle that is liable for the toll has been correctly set in the GO-Box in accordance with section 8.2.2
- The registration number of the vehicle that is liable for the toll was correctly registered with the system in accordance with section 5.6.

If any one of these conditions is not met, the user is obliged to pay the toll retroactively in accordance with section 7.1.

To verify the acoustic signals, the correct payment of the toll can be checked at any GO point of sale.

Drivers with a hearing disability are not exempt from these obligations. They are obliged to check that the toll has been properly paid at the aforementioned point of sales (see also section 8.2.4.4). Before doing so, the customer may also contact the ASFINAG SERVICE CENTER (see also section 5.3) to inquire whether the toll system is in working order.

8.2.4.4 After the trip

After all trips on the toll road network, the driver must once again check that the GO-Box is in technical working order and, if the GO-Box is not in proper working order (according to the provisions in section 8.2.4.2) must pay any unpaid or partially paid tolls by means of retroactive payment in accordance with section 7.1. Failure to comply with this provision constitutes a toll evasion offence in accordance with section 10.

9 MONITORING PAYMENT OF THE MANDATORY TOLL

9.1 Toll enforcement officers and their powers

Payment of the distance-related toll is monitored in two ways: by automatic checks and by toll enforcement officers.

Toll enforcement officers are public inspection officers. They are nominated by ASFINAG and are appointed and sworn in to the job by the local district administrative authorities. The law gives these toll enforcement officers powers of authority and powers to enforce administrative acts.

In order to monitor the correct payment of tolls, toll enforcement officers are authorized, among other things, to use clearly visible and audible signals to request drivers to stop; to stop drivers; to determine the identity of the driver and the registered owner; to inspect the vehicle, especially the vehicle registration documents, evidence for the allocation of the vehicle to a toll rate group (especially the vehicle logbook and the vehicle declaration), the GO-Box or another on-board unit, the tachograph, the odometer, and the control unit in accordance with Regulation (EEC) No. 3821/85, most recently amended by Regulation (EC) No. 432/2004 and, when driving in a vehicle carrying trade plates in accordance with section 2, evidence of the service weight of the vehicle (in particular a copy of the vehicle logbook) and evidence in accordance with section 5.2.3; and to verbally request the apprehended driver to pay the substitute toll.



Illustration 24

Moreover, in order to monitor the correct payment of tolls and to conduct traffic surveys, toll enforcement officers are authorized to use automatic traffic diversion equipment to divert traffic to toll inspection areas. Toll inspection areas are currently situated at the following locations: A1 Eberstalzell, A1 Haag, A1 Walserberg, A2 Arnoldstein (on the entry side and on the exit side), A2 Arnwiesen, A2 Haimburg, A2 Ilztal, A6 Kittsee (on the exit side), A4 Bruck/Leitha (travelling towards Vienna), A4 near Nickelsdorf (on the exit side), A4 Gols (travelling towards Vienna and travelling towards Nickelsdorf), A4 Zurndorf (travelling towards Vienna), A8 Kematen, A8 Suben, A9 Schoberpaß, A9 Straß, A10 Hoher Göll, A10 Kellerberg, A11 near Rosegg, A11 Karawanken Tunnel (on the exit side), A12 – inspection bay Roppener Tunnel Ostportal (km 125,80, travelling towards Bregenz), A12 – inspection bay Zirl Ost, A12 junction Wörgl-Ost (in both directions), A14 Hörbranz (on the entry side and on the exit side), A14 Nüziders, S4 Pöttsching (travelling towards Wr. Neustadt), S3 – inspection point Göllersdorf (travelling towards Stockerau), the Bings "Kettenanlegeplatz" (a bay where drivers can attach snow chains to the tyres on their vehicles) on the S16 (travelling towards Innsbruck), S31 Hirm Nord (travelling towards Eisenstadt), S31 Hirm Süd (travelling towards Mattersburg), and S37 near Maria Saal.

Additionally, toll enforcement officers may also monitor the correct payment of tolls and conduct traffic surveys at border crossings and junctions.

If no substitute toll is paid and if prosecution or execution of a sentence appear obviously impossible or very difficult, the toll enforcement officers are authorized in accordance with section 27 BStMG to request provision of a provisional security deposit or, if the stipulated provisional security deposit is not provided, to request in accordance with section 28 BStMG that the trip be interrupted and prevent its continuation by taking suitable preventative measures (e.g. confiscation of vehicle documents and keys, clamping of the vehicle, parking it in a suitable place and other similar measures).

Provisional security deposits may be provided in cash (euros) or using an authorized means of payment (appendix 2).

9.2 Toll enforcement officers' identification cards

The identification card for toll enforcement officers, which confirms their official status and must be carried at all times while on duty and shown to the person concerned on request, is the size of a cheque card, is printed on both sides, and contains the following information in particular: photograph, name, and duty number of the toll enforcement officer (see illustration 25).



Illustration 25

9.3 Toll enforcement officers' vehicles

The toll enforcement officers' vehicles are public security force enforcement vehicles that comply with the section section 20(1)(4) lit.a of the Motor Vehicle Act 1967. These vehicles are silver-grey operational vehicles that are equipped with flashing blue lights and a siren. Furthermore, the enforcement vehicles are marked with the following words: 'ASFINAG', 'Mautaufsicht' (toll enforcement), and 'Service- und Kontrolldienst der ASFINAG' (ASFINAG customer service and toll enforcement unit). See illustration 26 for details.



Illustration 26

10 TOLL EVASION

10.1 Penalties for toll evasion

It is prohibited to drive a vehicle that is liable for the toll within the meaning of Tolling Regulations Part B on the toll road network without correctly paying the distance-related toll. In accordance with section 20(2) BStMG, drivers who violate this prohibition are in breach of an administrative rule, which is punishable by the local district administrative authorities by imposing a fine of **€ 300.00** and **€ 3,000.00**.

If the driver of a vehicle that is liable for the toll is apprehended on the toll road network and found not to have a GO-Box or another authorized on-board unit in the vehicle, he or she must leave the toll road network immediately at the next possible exit.

Should the registered owner not provide evidence of the legitimacy of the requested EURO emission class in due time in accordance with the tolling regulations, the provisional allocation to the declared toll rate group will expire retroactively (*ex tunc*) in line with section 9 subsection 11 BStMG. In that case the vehicle is assigned to the toll rate group with the highest tariff retroactively. As per section 20 subsection 3 BStMG, registered owners who do not provide evidence for the allocation of the vehicle's declared EURO emission class in due time and thereby cause the payment of incorrect distance-related tolls for the use of toll road sections, are in breach of an administrative rule, which is punishable by the local district administrative authorities by imposing a fine of € 300.00 and € 3,000.00.

10.2 Non-imposition of a penalty

A penalty is not imposed if the driver pays a substitute toll, which is defined below. A substitute toll, which is paid in due time and in proper form, cannot be reclaimed.

10.3 Substitute toll

10.3.1 Method of payment

10.3.1.1 Apprehension by toll enforcement officers

If the driver of the vehicle is apprehended by toll enforcement officers, the toll must be paid retroactively if the conditions in section 7.1 are met. If the driver refuses to pay the toll retroactively or if the conditions in section 7.1 are not fulfilled, the toll enforcement officer is authorized to verbally request that the driver pay the substitute toll. The substitute toll must be paid immediately on request. Both the retroactive payment of the toll and the payment of the substitute toll may be made either in cash (euros) or using an authorized means of payment (appendix 2). The driver will then be given confirmation of payment containing a list of the toll road sections concerned.

10.3.1.2 Retroactive summons procedure

If a violation is detected by toll enforcement officers during the course of their work or if the incorrect payment of the toll was detected through automatic checks without the driver being apprehended in person, the registered owner(s) may receive a written request to pay the substitute toll.

This written request will provide details of the substitute toll to be paid, an identification number (ID No.), and details of a bank account.

The substitute toll must be transferred to the account indicated in the written request and must include the identification number (ID No.) given thereon. The obligation to pay the substitute toll is met when the substitute toll has been credited to the given account within four weeks of issuing the request and as long as the transfer order contains the complete and correct identification number, which must be written in such a way that it can be automatically read by a machine.

The substitute toll may not be paid in instalments. If instalments are received, they will be credited to the payer's account minus a processing fee of € 15.00 (including 20 % VAT). The same applies to late payments, payments that do not include the correct identification number (ID no.), or any payments made to any account other than the one indicated on the copy of the request to pay the substitute toll. In the event of overpayment by less than € 5.00, no money will be credited to the payer's account (otherwise the entire amount will be credited to the payer's account).

10.3.2 Substitute toll rate

The substitute toll rates (including 20 % VAT) for the incorrect payment of the distance-related toll are given below:

| REASON FOR SUBSTITUTE TOLL | SUBSTITUTE TOLL RATE |
|--|----------------------|
| Evidence for the requested EURO emission class incorrect or not provided by the deadline | EUR 240,00 |

| | |
|--|-------------------|
| Complete non-payment of the toll | EUR 240,00 |
| <p>Partial payment of the toll</p> <p style="text-align: center;"><u>1st case</u> Use of the wrong category (number of axles)</p> <p style="text-align: center;"><u>2nd case</u> Data discrepancy</p> <p>a) the registration number attached to the vehicle is not the same as the registration number given in the vehicle declaration (toll rate-related vehicle registration number violation) or</p> <p>b) the GO-Box identification number of the GO-Box in the vehicle is not the same as the GO-Box identification number in the vehicle declaration</p> | EUR 120,00 |

If multiple offences coincide, each of which is the separate partial payment of the toll (e.g. if a partial payment of the toll in accordance with the 1st case coincides with partial payment of the toll in accordance with the 2nd case), only one demand is sent for the substitute toll in the period relevant to the offences.

10.3.3 Initiation of administrative penal proceedings

If a driver is apprehended and requested to pay a substitute toll or if following a written request, a substitute toll is not paid, is paid in part, or not paid on time, administrative penal proceedings shall be initiated.

11 VIOLATION OF THE OBLIGATION TO STOP

Drivers who, contrary to section 18(2) BStMG, do not stop when instructed to do so by a toll enforcement officer are in breach of an administrative rule in accordance with section 21 BStMG and shall be fined up to **€ 3,000.00**.

12 PLACE OF JURISDICTION AND APPLICABLE LAW

The exclusive place of jurisdiction for all claims against ASFINAG under civil law arising out of these Tolling Regulations and/or the use of the toll road network shall be the court that has jurisdiction as regards such matters for the first district in Vienna. Only Austrian law applies, excluding the conflict of laws rules of private international law.

13 COMPETENCE AND CUSTOMER SERVICE

ASFINAG has entrusted ASFINAG Maut Service GmbH with the operation of the toll system and the collection of the toll on behalf of and for the account of ASFINAG. ASFINAG Maut Service GmbH is the company to contact for all procedural questions relating to the distance-related toll.

ASFINAG Maut Service GmbH

Am Europlatz 1

A-1120 Wien

AUSTRIA

Tel.: 0800 400 12 400 (free of charge when calling from Austria, Germany, or Switzerland)

Tel.: +43 (1) 95 51 266 (not free of charge when calling from all other countries)

Fax: +43 (1) 95 51 277

E-Mail: info@asfinag.at / <http://www.asfinag.at>

In so far as the persons involved do not have recourse to the courts of law or administrative courts, complaints regarding violations of the powers of toll enforcement officers or similar complaints may be directed either by post or by e-mail to ASFINAG Maut Service GmbH.

PART C: INTEROPERABILITY

In order to pay the toll in Austria, customers may use other on-board units (OBUs) in accordance with section 7 BStMG as long as these OBUs are authorized in accordance with the provisions below.

In order to use the authorized OBUs listed below, the provisions of Tolling Regulations Part B shall apply unless provisions are made in the sections that follow for special cases and/or deviations.

1 THE AUTHORISATION OF ON-BOARD UNITS USED FOR THE SWISS LSVA TOLL SYSTEM

1.1 General remarks

The Eidgenössische Zollverwaltung, Oberzolldirektion, Bern, (hereinafter also referred to as 'OZD') on the one hand and ASFINAG, represented by ASFINAG Maut Service GmbH (hereinafter also referred to as 'ASFINAG'), on the other provide a service to customers that allows customers of both toll systems to use the Swiss on-board unit to pay tolls in both Switzerland/Liechtenstein and in the Republic of Austria (hereinafter referred to as 'service'). The provision of this service does not affect the toll jurisdiction of either state.

Payment of the obligatory toll charges is still handled by the relevant toll collector (dual contract interoperability).

The following Swiss on-board units are authorized for the payment of tolls in Austria in accordance with section 7 BStMG

- Tripon
- Emotach

The on-board unit can only be used to pay tolls in conjunction with the post-pay procedure (for details on the methods and means of payment that are accepted for this procedure, see appendix 2 of the Tolling Regulations). Toll payment according to the pre-pay procedure is not possible.

The simultaneous use of several on-board units that are authorized in Austria for electronic toll payment can lead to multiple payments of the toll and is, therefore, impermissible. Multiple payments of the toll resulting from the simultaneous use of several on-board units shall not be refunded.

1.2 Provisions relating to the on-board unit

On-board units may only be obtained from and returned to the OZD in accordance with the conditions governing the Swiss LSVA toll system. They must be installed and kept operable in accordance with the standards of the LSVA toll system (see www.zoll.admin.ch for details). All questions regarding the on-board unit should be directed to the OZD. ASFINAG cannot maintain, repair, or exchange on-board units.

1.3 Registration

1.3.1. Registration procedure

Before the on-board unit is used to pay tolls in Austria for the first time, the vehicle that is liable for the toll must be registered. The relevant registration forms, which are available on the INTERNET at www.go-maut.at or from the ASFINAG SERVICE CENTER, must be used for registration.

The person registering with the system will be informed in writing by ASFINAG whether the registration has been accepted by ASFINAG and the OZD. If the registration is accepted, the registered owner will receive a chip card from the OZD within ten days. This card can be used to activate the on-board unit in Austria. It must be inserted into the on-board unit before the unit is used in Austria. The on-board unit indicates whether the unit is ready for use in Austria by displaying the codes '1001' or '1101' in the 'Gerät' (OBU) data field in the 'INFO/Fixe Daten/Vertrag' (Info/Fixed data/Contract) menu.

It is the sole responsibility of the customer to activate the on-board unit and to use the on-board unit properly in Austria.

The relevant registration forms, which are available on the INTERNET at www.go-maut.at or from the ASFINAG SERVICE CENTER, must be used when changing customer data.

In those cases where the swiss on board unit is used and a correct toll collection in Austria can not be ensured (in particular in cases where vehicles have transferable license plates) ASFINAG will exercise the right of refusal.

1.3.2. Declaration of the EURO emission class and changing data

Because the EURO emission class is not stored in the on-board unit and because the on-board unit is permanently installed and cannot be presented at a GO point of sale, documents that are required as evidence may only be submitted in advance. To this end, the provision of a valid e-mail address or other contact address is absolutely essential.

On the calendar day following conclusion of the document verification process (see section 5.2 of Tolling Regulations Part B), the proven EURO emission class will be entered in all toll gantries. Once this has occurred, this EURO emission class becomes relevant for the tolls to be paid. The claim to the billing of the toll rate for the proven EURO emission class begins the moment the EURO emission class is correctly entered in the relevant toll gantry.

Once the document verification process has been concluded, the valid vehicle declaration will be sent to the customer either per e-mail or by post. The vehicle declaration can also be obtained free of charge from a GO point of sale or in the SelfCare Portal at any time.

If any data changes, the documents required as evidence of the EURO emission class must also be sent to ASFINAG for verification in accordance with section 5.2.3 of Tolling Regulations Part B. Existing customers must send ASFINAG the relevant documents that are required as evidence in accordance with section 5.2 of Tolling Regulations Part B.

1.4 Data transfer

By registering with the system, the customer authorises the OZD and ASFINAG to save and exchange data relating to the customer and the vehicle that is liable for the toll and that is required for use of the on-board unit.

In order to ensure that tolls are paid correctly in Austria, ASFINAG and the OZD exchange the following data:

- business partner number
- LSVA master number
- vehicle registration number and country
- Personal Account Number (PAN)
- on-board unit identification number (OBU-ID)

1.5 The driver's obligations

1.5.1. The correct installation and operation of the on-board unit and the setting of the category in the on-board unit

The correct installation and operation of the on-board unit and the setting of the category are based on the relevant rules of operation for the on-board unit in use. For this reason, the on-board unit must be installed and kept operable in accordance with these standards.

Before beginning the journey, the driver must indicate on the on-board unit whether a trailer is attached to the vehicle. The declaration that a trailer is attached to the vehicle automatically triggers toll collection according to the rates in category 4.

1.5.2. Checking that the on-board unit is in working order

Once he or she has registered with the system, the vehicle driver must check before the start of every journey whether the on-board unit is working properly and whether toll payment in Austria is possible.

If the on-board unit cannot be used to pay tolls in Austria, the customer is obliged to use an Austrian GO-Box in accordance with the provisions of Tolling Regulations Part B. An Austrian GO-Box can be obtained at any GO point of sale. Please note that once he or she has switched over to the Austrian GO-Box, the driver must retroactively pay any tolls accrued in accordance with section 7 of Tolling Regulations Part B. This is a very important point because failure to do so (i.e. failure to pay accrued tolls after switching to a GO-Box) can constitute a toll evasion offence in accordance with section 10 of Tolling Regulations Part B.

1.6 Signals emitted by the on-board unit

When the vehicle passes a toll collection point, the 'short' acoustic signal emitted by the on-board unit indicates that the toll has been paid.

If the toll has not been correctly paid, either a 'long' acoustic signal (e.g. the on-board unit has been deactivated or the transaction has failed) is emitted or no acoustic signal is generated (no transaction made, e.g. because of a technical error). In these cases, the driver is obliged to pay the toll retroactively in accordance with section 7 of Tolling Regulations Part B. However, the on-board unit must not be presented at a GO point of sale. Instead the relevant on-board unit identification number for Austria or the vehicle registration number and the country in which the vehicle was registered must be provided. If the driver fails to do so, this can constitute a toll evasion offence (see section 10 of Tolling Regulations Part B).

1.7 Deregistering from the system

Customers can deregister from the toll system at any time. However, deregistration must take the written form only. The letter of deregistration must be sent to:

ASFINAG Maut Service GmbH
z.H. ASFINAG Service Center
Am Europlatz 1
1120 Wien
Austria

ASFINAG will then deactivate the on-board unit. Once this has happened, the on-board unit can no longer be used to pay tolls in Austria. The deactivation of the on-board unit is indicated by the sounding of a 'long' acoustic signal when the vehicle passes a toll collection point in Austria. Within ten days of deactivation, the OZD will send the registered owner a chip card by post. The registered owner is obliged to insert this chip card into the OBU immediately to reverse activation of the on-board unit. This will stop the unit from generating a 'long' signal when the vehicle passes a toll collection point in Austria.

2 DUAL CONTRACT INTEROPERABILITY WITH GERMANY ('TOLL2GO')

2.1 General remarks

Toll Collect GmbH (hereinafter also referred to as 'Toll Collect') on the one hand and ASFINAG, represented by ASFINAG Maut Service GmbH (hereinafter also referred to as 'ASFINAG'), on the other provide a service to customers that allows customers of both toll systems to use the German on-board unit (hereinafter referred to as 'TC OBU') to pay tolls in both the Federal Republic of Germany and in the Republic of Austria (hereinafter referred to as 'Toll2GO service'). The provision of the Toll2GO service does not affect the toll jurisdiction of either the Federal Republic of Germany or the Republic of Austria.

Payment of obligatory toll charges in Germany is still handled by Toll Collect and payment of obligatory toll charges in Austria is still handled by ASFINAG (dual contract interoperability).

2.2 Requirements for using the service in Austria

The applicant must be registered as a Toll Collect user and this registration must be active. He or she must also have a functioning TC OBU. This means that the TC OBU must have been provided by an existing Toll Collect service partner and correctly installed in the vehicle by the same in accordance with the relevant Toll Collect regulations before or at the latest by the time the application is submitted.

The TC OBU can only be used in Austria to pay tolls in conjunction with the post-pay procedure using the means of payment listed in appendix 2. The TC OBU cannot be used in conjunction with the pre-pay procedure.

In order to avail of this service, TC OBU users must register separately and correctly with ASFINAG (see section 2.3 for details).

In the following cases in particular, the TC OBU cannot be used to pay tolls in Austria:

- vehicles with vehicle registration numbers containing Cyrillic characters or other special characters;
- vehicles with an active Swiss on-board unit that is being used to pay tolls in Austria;
- vehicles with transferable license plates;

- vehicles with vehicle registration numbers issued in Austria before 2 January 1990 (i.e. vehicle license plate numbers with white characters on a black background);
- vehicles with metallized windscreens;
- in other cases where it is not possible to ensure that the toll is collected correctly.

In these cases, ASFINAG will make use of its right to refusal.

The simultaneous use of several on-board units that are authorized in Austria for electronic payment of the toll can lead to multiple payments of the toll and is, therefore, impermissible. Multiple payments of the toll as a result of such simultaneous use of several on-board units shall not be refunded.

2.3 Registration

2.3.1. Registering for the first time

Customers who have not yet registered for the Austrian toll system may, if they wish, conclude an initial contract with ASFINAG regarding the use of the TC OBU instead of using an Austrian GO-Box. If they decide to conclude such a contract, they do not need to acquire an Austrian GO-Box. A non-refundable processing fee of € 5 (incl. 20 % VAT) per activated TC OBU and/or per TC OBU that has been cleared for use must be paid to access the system (to register with the toll system).

In order to use the TC OBU in Austria, the conditions outlined below must be met.

2.3.1.1 Registration procedure

Before the correctly installed TC OBU is used to pay Austrian tolls for the first time, the vehicle that is liable for the toll must be registered with the truck toll system in Austria.

Customers must register electronically as follows using the SelfCare Portal:

Customers can register electronically using the www.go-maut.at website. During the registration process, the customer must provide the following information, which will be saved by ASFINAG and used for the purpose of toll collection:

- Toll Collect user number
- country in which the vehicle was registered
- vehicle registration number
- base category
- EURO emission class
- title
- name
- street
- house number
- post code
- town/city
- country of residence
- e-mail address
- language

- telephone number
- fax number
- card company
- card number (and possibly also the relevant card security code (CSC))
- valid until.

In order to use the TC OBU, the customer must accept Toll Collect's 'OBU-Einbuchung in Österreich' (OBU registration in Austria) conditions. The customer can accept these conditions on the SelfCare Portal. If the customer does not accept these conditions, he or she will not be able to use the TC OBU. In this case, the customer must use an Austrian GO-Box to pay the toll. Once the customer has entered the required data, ASFINAG will transfer the following data to

Toll Collect to complete the next stage of the registration process:

- Personal Account Number
- vehicle registration number and country where the vehicle was registered
- base category
- EURO emission class
- on-board unit identification number (OBU-ID)
- Toll Collect user number.

On the basis of the data transferred by ASFINAG, Toll Collect will check whether the conditions for using the TC OBU to pay tolls in Austria are met.

If the conditions are met, Toll Collect will initiate activation and clearance for use. Activation and clearance for use is an automatic process during which all relevant contractual data is entered in the TC OBU.

Following activation by Toll Collect, the vehicle registration numbers of those vehicles that have been cleared for use by Toll Collect for the Toll2GO service will be transferred to ASFINAG. The customer will be informed both in an e-mail from ASFINAG and in the SelfCare Portal of the fact that he or she can now use the TC OBU to pay tolls in Austria.

The fact that the OBU has been activated and cleared for use is also indicated on the TC OBU's display (for more information, please refer to the Toll Collect document 'Fahrzeuggerät Bedienungsanleitung' (On-board unit operating manual)).

If Toll Collect finds that the conditions for using the TC OBU to pay tolls in Austria are not met, the customer will be informed by ASFINAG both in an e-mail and in the SelfCare Portal of the fact that the TC OBU cannot (at present) be used to pay tolls in Austria.

2.3.2. Switching from an Austrian GO-Box to the TC OBU

Customers that have already registered their vehicle for the toll system in Austria also have the option of paying the toll correctly using a TC OBU rather than the Austrian GO-Box.

In this case, the customer is obliged to return the Austrian GO-Box (see section 2.3.2.2) once the TC OBU has been activated and cleared for use. In this case, a processing fee does not have to be paid in order to activate/clear a TC OBU for use.

This presupposes that all of the conditions outlined below are met.

2.3.2.1 Registration procedure

Before the correctly installed TC OBU is used to pay Austrian tolls for the first time, the vehicle that is liable for the toll must be registered with the toll system in Austria.

Customers must register electronically using the SelfCare Portal on the www.go-maut.at website. In the SelfCare Portal, the customer will find a list of vehicles that can in principle be used with the TC OBU. Once the customer has entered his/her access data for the SelfCare Portal, he/she can select the vehicles listed in the SelfCare Portal for which he/she would like to use to TC OBU for toll payment.

In order to use the TC OBU, the customer must accept Toll Collect's 'OBU-Einbuchung in Österreich' (OBU registration in Austria) conditions. The customer can accept these conditions on the SelfCare Portal. If the customer does not accept the conditions, he or she will not be able to use the TC OBU. In this case, the customer must use an Austrian GO-Box to pay the toll.

The customer is shown the data (vehicle registration number, country where the vehicle was registered, base category, and EURO emission class) for the vehicle registration number selected by the customer. Once the data has been entered, the customer cannot change the data (with the exception of the base category) himself/herself. For more information on the EURO emission class, please refer to section 2.3.3.

During the registration process, the customer can also change the means of payment used for the post-pay procedure or the type of contract (only from pre-pay to post-pay) (see also section 2.6).

On the basis of the data transferred by ASFINAG, Toll Collect will check whether the conditions for using the TC OBU to pay tolls in Austria are met.

For information on the subsequent stages of the verification, registration, and activation process, please refer to section 2.3.1.1 a).

2.3.2.2 Obligation to return the GO-Box

Once the TC OBU has been activated and cleared for use by Toll Collect, the customer is obliged to return the Austrian GO-Box to any GO point of sale. The customer will be informed of the obligation to return the GO-Box by two acoustic signals emitted by the TC OBU and four acoustic signals emitted by the Austrian GO-Box (see also section 2.12.3). If the customer does not comply with this obligation to return the GO-Box, ASFINAG reserves the right to deactivate the German on-board unit for payment of the toll in Austria too. Once this happens, the German on-board unit can only be re-activated by returning the GO-Box or by paying a non-refundable administrative fee of € 60 at any GO point of sale.

2.3.3. Declaration of the relevant EURO emission class

If the TC OBU is used for toll payment in Austria, all relevant contractual data shall be entered in the TC OBU in the course of activation and clearance for use. This means that for those cases where it is relevant for toll payment in Austria, only the EURO emission class for which evidence has been provided and which has been entered in the system for Austria will also be stored on the TC OBU.

As far as the EURO emission class is concerned, the following points must be observed:

a) Evidence of the EURO emission class has not yet been provided (e.g. in the case of registration for the first time)

It is important to determine whether the EURO emission class that is to be entered in the TC OBU is a EURO emission class for which evidence has to be submitted (i.e. EURO IV or better) or a EURO emission class for which no evidence is required (i.e. EURO I to III).

If the EURO emission class in question requires the submission of evidence, evidence of the EURO emission class must be provided before registration in accordance with section 5.2 of

Tolling Regulations Part B. Otherwise a EURO emission class for which no evidence is required will be entered during the registration process. It is not possible to make an advance declaration at a GO point of sale.

In the case of a EURO emission class that requires the submission of evidence, Toll Collect can only be asked to enter the proven EURO emission class in the TC OBU for payment of the toll in Austria after ASFINAG has verified the submitted evidence.

It is only the positive verification of evidence and the actual entry of the proven EURO emission class into the TC OBU by Toll Collect that justifies the claim to the billing of the toll rate allocated to the relevant toll rate group.

b) Evidence of the EURO emission class has already been provided (e.g. switchover from the Austrian GO-Box to the TC OBU)

During activation and clearance for use, existing contractual data, data that has been provided by the customer, and the EURO emission class for which evidence has most recently been provided for Austria and entered in the system will be entered in the TC OBU.

ASFINAG will instruct Toll Collect to enter data that is relevant to the contract and the proven EURO emission class in the TC OBU.

For those cases where a different EURO emission class has to be entered, please refer to section c) below.

It is only the actual entry of the proven EURO emission class in the TC OBU by Toll Collect that justifies the claim to the billing of the toll rate allocated to the relevant toll rate group.

c) Changing the EURO emission class

New evidence of a EURO emission class only has to be submitted in accordance with section 5.2 of Tolling Regulations Part B if the EURO emission class that has already been entered in the TC OBU has to be changed.

ASFINAG shall check the documents submitted as evidence.

Until such time as relevant documents are submitted as evidence to ASFINAG, tolls shall be paid on the basis of the EURO emission class that is already entered (and still stored) in the TC OBU. Once the evidence has been verified, ASFINAG will instruct Toll Collect to enter the (new) proven EURO emission class in the TC OBU.

This means that in the case of a EURO emission class for which evidence has to be submitted, ASFINAG can only instruct Toll Collect to enter the proven EURO emission class in the TC OBU after the evidence has been verified.

It is only the positive verification of evidence and the actual entry of the proven EURO emission class in the TC OBU by Toll Collect that justifies the claim to the billing of the toll rate allocated to the relevant toll rate group.

2.3.4. Vehicle declaration

Following successful registration (i.e. once Toll Collect has activated the TC OBU and cleared it for use), the customer shall receive a vehicle declaration in accordance with section 5.2.1 of Tolling Regulations Part B.

Instead of the GO-Box identification number, the valid on-board unit identification number for Austria will be printed on the vehicle declaration.

If the stored vehicle data is changed in accordance with section 2.6, the original vehicle declaration will remain valid until such time as a new vehicle declaration is issued.

All vehicle declarations will be sent to the customer at the e-mail address provided by the customer. Moreover, the vehicle declaration can be obtained free of charge from a GO point of sale or the SelfCare Portal.

2.4 Right to refusal

Neither ASFINAG nor Toll Collect are obliged to approve use of the TC OBU for a specific vehicle. In fact, ASFINAG and Toll Collect have the right to refuse use either during the registration process or at a later date. If use is refused, the TC OBU cannot be used for toll payment in Austria. The right to assert claims against ASFINAG resulting from this refusal is expressly excluded.

2.5 The storage and exchange of data

When a customer registers, he or she expressly authorises Toll Collect and ASFINAG to exchange the data needed to allow the TC OBU to be used for toll payment in Austria. The following data is included in the exchange of information:

- general customer data such as the Toll Collect user number;
- technical data relating to the vehicle and the TC OBU insofar as the exchange of data is necessary for activation, clearance for use, and deactivation in accordance with sections 2.3.1 and 2.3.2;
- data needed for toll payment in Austria:
 - deactivation and re-activation of the TC OBU (deactivation data is only exchanged insofar as a deactivation and/or re-activation affects payment of the toll in Austria);
- statistical data for the purpose of quality measurement and quality analysis of the TC OBU:
 - total number of successful MTRs
 - individual data sets relating to retroactive billing (LSID, timestamp)
 - individual data relating to tolls that were not collected (LSID, timestamp).

If a customer, for whatever reason, would like to revoke his/her authorisation to exchange data, he or she must inform both ASFINAG and Toll Collect of this revocation in writing and must provide the vehicle registration number and personal account number (PAN) affected by the revocation in accordance with section 5.6.1 of Tolling Regulations Part B. Once the revocation has been received, ASFINAG will deactivate the TC OBU for toll payment in Austria and Toll Collect will deactivate the Toll2GO service for the customer's relevant vehicle registration numbers. Once the TC OBU has been deactivated for Austria, tolls must be paid using the Austrian GO-Box.

Please note that for the period between ASFINAG's receipt of the revocation and the actual deactivation by Toll Collect, the TC OBU will emit four brief acoustic signals whenever it passes a toll collection point. The TC OBU will only stop emitting acoustic signals once Toll Collect has completed the technical deactivation of the Toll2Go service.

2.6 Data changes

In derogation of section 5.6.2 of Tolling Regulations Part B, the following provisions apply to data changes:

a) Changing vehicle data

Changes must be sent to ASFINAG either via the SelfCare Portal or in writing.
It is not possible to make data changes directly at a GO point of sale.

b) Changing customer data

Customer data can only be changed in writing.
It is not possible to make customer data changes directly at a GO point of sale or in the SelfCare Portal.

c) Changing the means of payment

The means of payment is the only data change that can be made directly at a GO point of sale.
The means of payment can also be changed in the SelfCare Portal or in writing. Please refer to appendix 2.

Data changes that are submitted to ASFINAG in written form must be sent to the following address:

ASFINAG Maut Service GmbH
z.H. ASFINAG Service Center
Am Europlatz 1
1120 Wien
Austria

On the basis of the changes made known by the customer, ASFINAG will instruct Toll Collect to make the relevant data changes to the TC OBU.

Data changes that are made known to Toll Collect only are not binding for ASFINAG. Customers should note that not making relevant data changes known constitutes a toll evasion offence in accordance with section 10. ASFINAG will make every effort to enter data changes about which it subsequently finds out (especially changes to vehicle registration numbers). However, such changes will not have any effect on breaches of administrative rule that have already been committed.

2.7 The sale or rental of vehicles

The provisions in section 5.6.4.2 of Tolling Regulations Part B apply accordingly to the rental of vehicles.

If a registered owner sells his/her vehicle, for which a TC OBU has been activated and cleared for use, he or she is obliged to inform ASFINAG of this fact in writing. If he or she does not do so, the registered owner shall assume sole responsibility for the billing and payment of future Austrian toll transactions. The act of informing ASFINAG of the sale of the vehicle is considered a written deregistration of the TC OBU and means that this on-board unit can no longer be used for toll payment in Austria (for more information, please refer to section 2.10 'Deregistering the TC OBU').

The person who buys the vehicle is obliged to register with the toll system before using the Austrian toll road network for the first time.

2.8 Provisions relating to the TC OBU

Toll Collect GmbH is the sole contact for matters relating to the TC OBU:

Toll Collect GmbH
Postfach 11 03 29
10833 Berlin
Germany

The relevant Toll Collect provisions shall apply to the installation, exchange, and return of the TC OBU. If the TC OBU is used to pay tolls in Austria, the driver must make sure that Toll Collect's conditions regarding installation and use are observed. In particular, the driver must make sure that the area above the DSRC module as well as an area 190 mm from the driver's side and 70 mm from the front-seat passenger are kept clear.

For this reason, all claims relating to the TC OBU should be addressed to Toll Collect, especially those claims relating to the provision of maintenance, repair, and exchange services. These services are provided either directly by Toll Collect or by a Toll Collect service partner. In the event of theft, loss, and deactivation, section 5.7.3 of Tolling Regulations Part B shall apply accordingly, whereby in this case, no administrative fee is payable to ASFINAG.

Generally speaking, because the TC OBU is securely installed in the vehicle, it cannot be removed by either ASFINAG or the customer. In those cases where, in accordance with the provisions of Tolling Regulations Part B, the on-board unit has to be presented (in particular at the GO points of sale), customers using a TC OBU must provide the on-board unit identification number that is valid for Austria, the vehicle registration number, and the country where the vehicle was registered.

Both ASFINAG and Toll Collect are entitled to deactivate the TC OBU in the event of technical faults or if they discover irregularities in the collection of tolls. The TC OBU will be deactivated should certain technical error patterns arise (e.g. an accumulation of instances where tolls could not be correctly collected, incomplete transaction data etc.). If the TC OBU is deactivated, the driver will be notified of this fact by the sounding of four acoustic signals.

2.9 GO points of sale

Staffed GO points of sale are available to customers using the TC OBU for the following services in particular:

- the retroactive payment of tolls;
- the return of Austrian GO-Boxes;
- the changing of the means of payment used for the post-pay procedure;
- the issuing of Austrian GO-Boxes;
- the conclusion of rental contracts;
- information about the status of the TC OBU;
- the issuing of vehicle declarations;
- the payment of administrative fees.

Customers using TC OBUs cannot use GO vending machines.

2.10 Deregistering the TC OBU

One or more TC OBUs can be deregistered for toll payment in Austria in writing at any time. The letter of deregistration must be sent to the following address:

ASFINAG Maut Service GmbH
z.H. ASFINAG Service Center
Am Europlatz 1
1120 Wien
Austria

Customers can also deregister their TC OBUs via the SelfCare Portal.

Once ASFINAG has received the letter of deregistration, ASFINAG will immediately deactivate the TC OBU for toll payment in Austria. ASFINAG shall inform the customer by e-mail about the completion of the deregistration process. From this point on, toll in Austria must be paid using an Austrian GO-Box.

ASFINAG shall inform Toll Collect about the deregistration. Toll Collect shall immediately initiate the necessary deactivation of the Toll2GO service on the TC OBU. Please note that for the period between ASFINAG's receipt of the revocation and the actual deactivation by Toll Collect, the TC OBU will emit four brief acoustic signals whenever it passes a toll collection point. The TC OBU will only stop emitting acoustic signals once Toll Collect has completed the technical deactivation of the service.

Customers should note that Toll Collect is also entitled to exclude the TC OBU from being used for toll payment in Austria. The customer must make sure in good time that tolls can be paid correctly in Austria, if necessary using an Austrian GO-Box. Customers should note that they are obliged to pay toll retroactively in accordance with section 7 of Tolling Regulations Part B.

As soon as Toll Collect informs ASFINAG that a TC OBU has been excluded, ASFINAG will inform the customer by e-mail and via the SelfCare Portal.

ASFINAG is not obliged to check whether Toll Collect's decision to exclude the TC OBU is legitimate and is not responsible for doing so.

2.11 Retroactive toll payment

In cases where tolls are not paid correctly, the customer must pay the toll retroactively in accordance with section 7 of Tolling Regulations Part B. Both when making retroactive payment at a GO point of sale or to a toll enforcement officer and when making central retroactive payment, the customer must provide the on-board unit identification number that is valid for Austria, the vehicle registration number, and the country where the vehicle was registered.

Section 7 of Tolling Regulations Part B applies with the proviso that it is not possible to obtain information about toll transactions at GO points of sale because the TC OBU is securely installed in the vehicle and cannot, therefore, be presented at a GO point of sale.

For all details on the authorized means of payment, please refer to appendix 2 of the Tolling Regulations.

2.12 The driver's obligations

2.12.1. The correct installation and operation of the TC OBU and setting the category in the TC OBU

The correct installation and operation of the TC OBU and the setting of the category are based on Toll Collect's relevant rules of operation. For this reason, the TC OBU must be installed and kept operable in accordance with Toll Collect's standards.

If a trailer or a road semi-trailer is attached to the vehicle, the vehicle driver must set the vehicle category in the TC OBU in accordance with the Toll Collect document 'Fahrzeuggerät Bedienungsanleitung' (On-board unit operating manual) before using the toll road network. The actual number of axles of the towing vehicle together with the number of axles of the (semi-) trailer, regardless of the maximum gross vehicle weight of the (semi-) trailer, determines the category that is to be set. The declared number of axles can be read on the display of the TC OBU.

2.12.2. Checking that the TC OBU is in working order

Once the TC OBU has been activated and cleared for use, the vehicle driver must check before the start of every journey whether the TC OBU is working properly and whether toll payment in Austria is possible.

For more information on how to do so, please refer to the Toll Collect document 'Fahrzeuggerät Bedienungsanleitung' (On-board unit operating manual).

If toll payment in Austria is not possible with the TC OBU, the customer is obliged to use an Austrian GO-Box in accordance with Tolling Regulations Part B. An Austrian GO-Box can be obtained from any GO point of sale. Please note that once he or she has switched over to the Austrian GO-Box, the driver must make sure that any tolls accrued in accordance with section 2.11 are paid retroactively. This is a very important point because failure to do so (i.e. failure to pay accrued tolls after switching to a GO-Box) can constitute a toll evasion offence in accordance with section 10 of Tolling Regulations Part B.

2.12.3. Acoustic signals emitted by the TC OBU

Vehicle drivers must pay attention to the acoustic signals emitted by the TC OBU while on the move. Should any irregularities occur, the nearest GO point of sale has to be contacted, where an Austrian GO-Box can be obtained and an obligation to make retroactive payment in accordance with section 2.11 of Tolling Regulations Part C can be met .

In accordance with section 8.2.4.3 of Tolling Regulations Part B, the customer must observe the following acoustic signals emitted by the TC OBU, each of which is associated with different obligations:

- **ONE brief acoustic signal (beep)**

This signal means that toll payment is confirmed on the basis of the set category (number of axles) and the EURO emission class stored in the on-board unit.

- **TWO brief acoustic signals (beeps)**

Here too, the sounding of two beeps means that the toll has been paid on the basis of the set category (number of axles) and the EURO emission class stored in the on-board unit. However, two beeps mean that the vehicle driver must go to the nearest GO point of sale immediately, where he/she will be informed of what further (obligatory) action he/she has to take (e.g. information that the GO-Box must be returned).

Please note that a failure to observe this request can lead to the automatic deactivation of the on-board unit for toll payment in Austria.

- **FOUR short acoustic signals (beeps)**

The sounding of four beeps means that the toll was not paid correctly (e.g. four beeps are sounded when the on-board unit has been deactivated or alert the driver to a faulty transaction). In this case, the customer is obliged in accordance with section 2.11 to go to a GO point of sale within 5 hours and 100 kilometres and to retroactively pay the toll for the relevant toll road sections.

- **NO acoustic signal (no beep)**

No beep means that no toll was paid (e.g. when a transaction was not completed because of a technical error). The only time when the customer is not obliged to retroactively pay the toll in accordance with section 7 of Tolling Regulations Part B is when the preconditions of section 8.2.4.3.3 of Tolling Regulations Part B are met.

- **Carrying both a TC OBU and an Austrian on-board unit in the vehicle simultaneously**

If a vehicle contains both the TC OBU and the Austrian GO-Box simultaneously, it is possible that one of these two on-board units might indicate by sounding four beeps that the toll was not paid. The only time when the customer is not obliged to retroactively pay the toll in accordance with section 2.11 is when the toll was correctly paid by the other on-board unit, a fact indicated by the sounding of one or two beeps.

3 THE AUTHORISATION OF ON-BOARD UNITS ACTIVATED FOR THE EASYGO+ SERVICE

3.1 General remarks

Together, the members of the EasyGo toll consortium (which comprises toll operators from Denmark, Norway, Sweden, and Austria) have succeeded in implementing a single-contract interoperability solution for motor vehicles with a maximum gross vehicle weight (GVW) of more than 3.5 t. Hereinafter this service shall be referred to as the 'EasyGo+ service'.

If used properly, the EasyGo+ service allows service users to pay the distance-related toll in Austria and the toll at various points in Denmark, Sweden, and Norway using a single on-board unit (hereinafter referred to as the 'EasyGo+ OBU') that has been activated for the EasyGo+ Service .

Please note that service users can only pay the toll in Austria for motor vehicles with a maximum GVW of more than 3.5 t if the EasyGo+ service has been activated. Please also note that it is not possible to pay the toll in Austria if using the EasyGo Service (regardless of the maximum GVW of the motor vehicle).

For a list of toll (point) operators and for other useful information on the EasyGo and/or EasyGo+ services, please visit www.easygo.com. ASFINAG does not assume any responsibility or liability for the timeliness, correctness, and completeness of the information given on www.easygo.com, which can be amended, supplemented, or removed without prior notice at any time.

3.2 Provisions relating to the on-board unit (hereinafter referred to as the EasyGo+ OBU)

The EasyGo+ OBU can only be obtained from and returned to toll service providers who provide the EasyGo+ service and as long as the EasyGo+ OBU is authorized for toll payment in Austria.

In accordance with section 7 BStMG, the EasyGo+ OBU can currently be authorized for toll payment in Austria by:

- **'BroBizz+',** as long as the EasyGo+ service is used on this OBU and is activated by the toll service provider BroBizz A/S;

Service users must direct all questions regarding the EasyGo+ OBU to their respective toll service providers. For this reason, all claims relating to the EasyGo+ OBU must be addressed to the toll service provider, especially those claims relating to the provision of maintenance, repair, and exchange services.

The EasyGo+ OBU must be operated and kept serviceable in accordance with the instructions of the toll service provider. For instructions on the attachment and operation of the EasyGo+ OBU, please refer to section 3.5.2.

The simultaneous use in a single motor vehicle of several on-board units that are authorized for electronic toll payment in Austria can lead to multiple toll payments. In this case, ASFINAG is not obliged to refund the excess toll payments.

3.3 Registering with and de-registering from the EasyGo+ service

Toll service providers alone are responsible for organising the registration with/de-registration from the EasyGo+ service. In other words, service users must contact their respective toll service providers in order to register with/de-register from the EasyGo+ Service.

Please note that the provision and verification of evidence relating to the EURO emission class when using an EasyGo+ OBU is not ASFINAG's responsibility. Service users are not required to provide additional evidence to ASFINAG. However, ASFINAG has the right to ask the toll service provider to provide the documents that were submitted as evidence and used to determine the EURO emission class (for which evidence must be provided) that has been stored on the EasyGo+ OBU. The toll service provider is obliged to comply with this request. However, when using the EasyGo+ service, service users are obliged to check the vehicle declaration provided by the toll service provider and to carry both this declaration and the relevant evidence (in accordance with Part B, section 5.2.3) in the vehicle at all times in order to ensure that the allocation of a EURO emission class to a toll rate group can be verified at any time.

If—for whatever reason or at whatever time—a service user has used a 'local' Austrian GO-Box or another authorized on-board unit other than the EasyGo+ OBU (e.g. TC OBU, Emotach) to pay the toll in Austria, uses them simultaneously, or intends to use one in the future, the relevant processes and the obligation to provide timely and correct evidence of the EURO emission class in accordance with Part B and Part C (sections 1 and 2) remain unaffected.

3.4 The storage and exchange of data

When a service user uses the EasyGo+ service for toll payment in Austria, he or she expressly authorises ASFINAG and the toll service provider to exchange, store, and process the data needed to allow the EasyGo+ OBU

- a) to be used for toll payment in Austria and
- b) to penalise any infringements of the ban on using the toll road network without correct toll payment.

3.4.1. Correct toll payment with the EasyGo+ OBU

In order to ensure that the EasyGo+ OBU can be used for toll payment in Austria, ASFINAG stores, processes, and exchanges the following data in particular:

- vehicle-specific data
 - vehicle registration number and country where the vehicle was registered
 - EURO emission class
 - base category
 - European Vehicle Group
- Personal Account Number (PAN)
- on-board unit identification number (EasyGo+ OBU ID)
- relevant toll service provider
- type of contract (stored by the toll service provider)
- data for the de-activation and re-activation of the EasyGo+ OBU by the toll service provider
- data for toll billing
 - successfully collected tolls
 - unsuccessfully collected tolls
 - retroactively billed and collected tolls
 - toll road section used
 - time the toll road section was used

By using the EasyGo+ service, the service user accepts that ASFINAG stores and processes the data listed above and exchanges this data with the relevant toll service provider for the purpose of toll charging, quality measurement, and quality analysis.

3.4.2. Incorrect toll payment with the EasyGo+ OBU

If the toll is not correctly paid (see in particular Part B, section 10: 'Toll evasion'), the toll service provider sends ASFINAG the data required to send the registered owner a written request to pay the substitute toll or to initiate administrative penal proceedings.

3.5 Obligations

3.5.1. Vehicle declaration

Before using the Austrian network of motorways and expressways, the service user is obliged to check whether:

- the vehicle registration number attached to the vehicle and the country where the vehicle was registered and
- the OBU ID on the EasyGo+ OBU

are the same as those given in the vehicle declaration.

If they are not or if no valid EasyGo+ service contract has been concluded, the service user must refrain from his or her intention to pay the toll using the EasyGo+ OBU. Failure to comply with this provision can constitute a toll evasion offence (see section 10 of Tolling Regulations Part B).

In this case, the service user can pay the toll using the 'local' Austrian GO-Box in accordance with the provisions of Tolling Regulations Part B (see also section 3.8).

Moreover, the service user is obliged to carry the vehicle declaration he/she received from the toll service provider and to show both this declaration and the documents that allow for verification of the allocation of a EURO emission class to a toll rate group (in accordance with Part B, section 5.2.3) to officers in the event of an inspection.

If the service user needs to change any data (especially toll rate-related data), he/she must contact the relevant toll service provider (see also section 3.7).

3.5.2. Installation and operation of the EasyGo+ OBU

The EasyGo+ OBU must be operated and kept serviceable in accordance with the instructions of the toll service provider. The EasyGo+ OBU must be installed in accordance with the instructions of the toll service provider and, when using the Austrian toll road network, in accordance with the regulations for the correct installation of the 'local' Austrian GO-Box (see in particular section 8.1 of Tolling Regulations Part B). Failure to do so can constitute a toll evasion offence (see section 10 of Tolling Regulations Part B).

3.5.3. Declaring and setting the category

Before the start of every journey, the service user must check and set the category. The actual number of axles of the towing vehicle together with the number of axles of the (semi-)trailer—regardless of the maximum gross vehicle weight of the (semi-)trailer—determines the category that is to be set.

The axles of a trailer are not taken into account when setting the number of axles for buses and caravans.

3.5.4. Checking that the EasyGo+ OBU is in working order

The service user must check that the EasyGo+ OBU is in working order before, during, and at the end of every trip. If toll payment in Austria is/was not possible with the EasyGo+ OBU, the service user should use a 'local' Austrian GO-Box (see also section 3.8). **Please note** that if the toll was not correctly paid, the service user must retroactively pay any tolls accrued in accordance with section 3.6. Failure to comply with this obligation can constitute a toll evasion offence in accordance with section 10 of Tolling Regulations Part B.

3.5.5. Acoustic signals emitted by the EasyGo+ OBU

Service users must pay attention to the acoustic signals emitted by the EasyGo+ OBU while on the move. If any irregularities occur, the service user must go to the nearest GO point of sale,

where he or she can obtain a 'local' Austrian GO-Box (see also section 3.8) and comply with the obligation to make retroactive payment (see section 3.6).

In accordance with section 8.2.4.3 of Tolling Regulations Part B, the customer must observe the following acoustic signals emitted by the EasyGo+ OBU, each of which is associated with different obligations on the part of the service user:

- **ONE** brief acoustic signal (beep)
One beep means that toll payment is confirmed on the basis of the set category (number of axles) and the EURO emission class stored in the EasyGo+ OBU.
- **TWO** brief acoustic signals (beeps)
Two beeps means that toll payment is confirmed on the basis of the set category (number of axles) and the EURO emission class stored in the EasyGo+ OBU. The toll service provider will be happy to provide information on any service user obligations.
- **FOUR** short acoustic signals (beeps)
FOUR beeps means that the toll was not correctly paid. In this case, the service user is obliged in accordance with section 3.6 to go to a GO point of sale and to retroactively pay the toll for the relevant toll road sections. He/she should also use a 'local' Austrian GO-Box before continuing the journey on the toll road network (see also section 3.8).
- **NO** acoustic signal (no beep)
No beeps means that no toll was paid. The only time when the customer is not obliged to retroactively pay the toll in accordance with section 3.6 of Tolling Regulations Part C is when the preconditions outlined in section 8.2.4.3.3 of Tolling Regulations Part B are met.

3.6 Retroactive toll payment

In cases where tolls are not correctly paid, the service user must pay the toll retroactively in accordance with section 7 of Tolling Regulations Part B. Failure to do so can constitute a toll evasion offence (see section 10 of Tolling Regulations Part B). The following specific provisions apply when using the EasyGo+ service:

- The EasyGo+ OBU must not be presented at a GO point of sale. Instead, the vehicle declaration must be presented as a means of identification. Alternatively, the vehicle registration number and the country in which the vehicle was registered can be provided.
- It is not possible to obtain information about toll transactions at a GO point of sale.
- If the category used was too low, central retroactive payment can only be made by calling the ASFINAG Service Center by telephone.
- Retroactive payment is made directly to ASFINAG (in other words not via the toll service provider). For all details on the authorized means of payment, please refer to appendix 2 of the Tolling Regulations.
- No provisions are made for retroactive payment in conjunction with the EURO emission class because the toll service provider will already have checked the EURO emission class.

3.7 Responsibilities and services

3.7.1. Toll service providers

As a rule, the service user must always contact his or her toll service provider first. In the following cases, for example, the service user must always contact his or her toll service provider:

- registration with and de-registration from the EasyGo+ service;
- handover and personalisation of an EasyGo+ OBU;
- checking of the EURO emission class;
- the issuing of vehicle declarations;
- payment procedures, especially invoicing and information on invoices;
- data changes, especially vehicle data, service user data, means of payment;
- de-activation and re-activation of the EasyGo+ OBU (e.g. in the event of the loss of the EasyGo+ OBU);
- maintenance, repair, and exchange services relating to the EasyGo+ OBU;
- information regarding the sale or rental of vehicles using the EasyGo+ service.

3.7.2. GO points of sale

GO points of sale are available to users of the EasyGo+ service in the following cases in particular:

- the retroactive payment of tolls (at staffed GO points of sale only);
- the issuing of 'local' Austrian GO-Boxes;
- the return of 'local' Austrian GO-Boxes.

Customers using the EasyGo+ service cannot use GO vending machines.

3.7.3. ASFINAG SERVICE CENTER (ASC)

Service users can call the ASC using one of the following numbers: 0800 400 12 400 (when calling from inside Austria) or +43 1 955 12 66 (when calling from outside Austria). The ASC is on hand to take central retroactive payments in the event of the use of the wrong category (number of axles) and to answer any general questions and issues relating to the Austrian toll system.

3.7.4. Special features

Service users cannot avail of the functions of the SelfCare Portal and GO vending machines or the services they provide. Nor shall ASFINAG Maut Service GmbH provide service users with itemized toll information sheets or collective invoice statements (in accordance with section 6 of Tolling Regulations Part B). The services available depend on the respective toll service provider. The service provider reserves the right to amend the type and scope of these services.

3.8 Using the 'local' Austrian GO-Box

If toll payment in Austria is not possible with the EasyGo+ OBU, the service user is obliged to use a 'local' Austrian GO-Box in accordance with Tolling Regulations Part B. The 'local' Austrian GO-Box can be obtained from any GO point of sale. **Please note** that once he or she has switched over to the 'local' Austrian GO-Box, the service user must retroactively pay any tolls accrued in accordance with section 3.6 of Tolling Regulations Part C or section 7 of Tolling Regulations Part B. This is a very important point because failure to do so (i.e. failure to pay accrued tolls after switching to a GO-Box) can constitute a toll evasion offence in accordance with section 10 of Tolling Regulations Part B.

In the following cases in particular, the toll in Austria must be paid using a 'local' Austrian GO-Box:

- if the EasyGo+ OBU experiences a technical failure;
- if the EasyGo+ OBU is de-activated;
- if the data on the vehicle declaration is not the same as the registration number attached to the vehicle, the country in which the vehicle was registered, and the OBU ID of the EasyGo+ OBU.

Please note that the simultaneous use of several on-board units that are authorized for electronic toll payment in Austria can lead to multiple toll payments. In this case, ASFINAG is not obliged to refund the excess toll payments.

4 THE AUTHORISATION OF ON-BOARD UNITS FOR TOLL PAYMENT IN AUSTRIA WITHIN THE SCOPE OF THE “REGIONAL EUROPEAN ELECTRONIC TOLL SERVICE” (“REETS”)

4.1 General remarks

Directive 2004/52/EC on the interoperability of electronic toll systems in the European Community formed the basis of the REETS-TEN (Regional European Electronic Toll Service - Trans European Network) project. The REETS project aimed at enabling the development of EETS-compliant services in the cross-border collaboration of the regional pilot project.

With this in mind, ASFINAG acts as toll charger in Austria in connection with the rendering of REETS.

If the on-board unit (hereinafter REETS OBU) has been authorized by ASFINAG for toll payment in Austria, it will be made available to the customer (hereinafter service user) by the service provider.

Please note that the customer can only pay the toll in Austria for motor vehicles with a maximum gross vehicle weight (GVW) of more than 3.5 tonnes if the REETS OBU has been authorized for the Austrian toll area.

4.2 Provisions relating to the on-board unit (REETS OBU)

A REETS OBU may only be obtained from and returned to service providers who also offer REETS for the Austrian toll area and if their REETS OBU is authorized for toll payment in Austria.

REETS OBUs that are authorized for toll payment in accordance with section 7 BStMG may, if REETS should be used, be authorized by the service provider for toll payment in Austria.

The service providers authorized for toll payment in Austria are listed in appendix 2, point 3.1.2.5.

The sole contact person for the service provider in connection with the REETS OBU is the respective service provider of the service user. All claims regarding the REETS OBU are therefore to be brought against the service provider, especially in relation to the rendering of maintenance, repair and replacement services.

The REETS OBU must be operated and kept serviceable in accordance with the instructions of the service provider. Particular reference is made to point 4.5.2 with regard to the installation and operation of the REETS OBU in the Austrian toll area.

4.3 Registration with and de-registration from REETS

Registration with and de-registration from REETS falls solely within the remit of the respective service provider and is to be arranged between the service provider and the service user.

Please note that ASFINAG is not responsible for providing and validating proof in connection with the EURO emission class when using a REETS OBU. There is no need for the service user to render ASFINAG additional proof. However, ASFINAG has the right to request from the service provider those documents that were submitted as evidence and used to determine the EURO emission class that was stored on the REETS OBU. The service provider is obliged to comply with this request. However, when using REETS, the service user is required to check the vehicle declaration submitted by the service provider and to carry it in the motor vehicle together with the required evidence (in accordance with Part B, point 5.2.3) in order to make it possible to verify the allocation of a EURO emission class to a rate group.

If - for whatever reason or at whatever time - a service user has used, is using or will in future use a "local" Austrian GO-Box or another on-board unit authorized in Austria which is different from the REETS OBU (e.g. TC OBU, Emotach) to pay the toll in Austria, the procedures in this regard and the obligation to render evidence of the EURO emission class on time and in due form in accordance with Part B and Part C (points 1 and 2) remain unaffected.

4.4 The storage and exchange of data

By using REETS for toll payment in Austria, the service user expressly authorises ASFINAG and the service provider to exchange, store and process the data required so that toll payment in Austria

a) can be ensured and performed with the REETS OBU and

b) to penalise any infringements of the ban on using the toll road network without correct toll payment.

4.4.1. Correct toll payment with the REETS OBU

In order to ensure that the REETS OBU can be used for toll payment in Austria, ASFINAG stores, processes and exchanges the following data in particular with the service provider:

- vehicle-specific data
 - vehicle registration number and country of registration
 - EURO emission class
 - base category
 - vehicle type
- Personal Account Number (PAN)
- on-board unit identification number (REETS OBU ID)
- relevant service provider
- data for deactivation and re-activation of the REETS OBU by the service provider
- data for toll billing
 - successfully collected tolls
 - unsuccessfully collected tolls
 - retroactively billed and collected tolls
 - toll road section used
 - time the toll road section was used

By using REETS the service user accepts that ASFINAG stores, processes and if necessary exchanges the data listed above with the relevant service provider for the purpose of toll charging, quality measurement and quality analysis.

4.4.2. Incorrect toll payment with the REETS OBU

If the toll is not correctly paid (see in particular Part B, section 10 “Toll evasion”), the service provider may provide ASFINAG with the data required to send the registered vehicle owner a written request to pay the substitute toll or to initiate administrative penal proceedings.

4.5 Obligations

4.5.1. Vehicle declaration

Before using the Austrian network of motorways and expressways, the service user is obliged to check whether:

- the vehicle registration number attached to the vehicle and the country where the vehicle was registered and
- the OBU ID on the REETS OBU

are the same as those given in the vehicle declaration.

If they are not or no valid REETS contract has been concluded, the service user must refrain from his or her intention to pay the toll using the REETS OBU. Failure to comply with this provision can constitute a toll evasion offence (see section 10 of Tolling Regulations Part B).

In this case, the service user can pay the toll using the “local” Austrian GO-Box in accordance with the Tolling Regulations Part B (see also section 4.8).

Furthermore the service user is also obliged to carry the vehicle declaration provided by the respective service provider and show this declaration as well as the documents that verify the allocation of a EURO emission class to a toll rate group (in accordance with Part B, section 5.2.3) to officers in the event of an inspection.

If the service user needs to change any data (especially toll rate-related data), he/she must contact the relevant service provider (see also section 4.7).

4.5.2. Installation and operation of the REETS OBU

The REETS OBU must be operated and kept serviceable in accordance with the instructions of the service provider. The REETS OBU must be installed in accordance with the instructions of the Service provider and, when using the Austrian toll road network, in accordance with the regulations for the correct installation of the “local” Austrian GO-Box (see in particular section 8.1 of Tolling Regulations Part B). Failure to do so can constitute a toll evasion offence (see section 10 of Tolling Regulations Part B).

4.5.3. Declaring and setting the category

Before the start of every journey, the service user must check and set the category. The actual number of axles of the towing vehicle together with the number of axles of the (semi-)trailer – regardless of the maximum permitted gross weight of the (semi-)trailer – determines the category that is to be set.

The axles of a trailer are not taken into account when setting the number of axles for buses and caravans.

4.5.4. Checking that the REETS OBU is in working order

The service user must check whether the REETS OBU is in working order before, during, and at the end of every trip. If toll payment in Austria is/was not possible with the REETS OBU, the service user should use a “local” Austrian GO-Box (see also section 3.8). Please note that if the toll was not correctly paid, the service user must retroactively pay any tolls accrued in accordance with section 4.6. Failure to comply with this obligation can constitute a toll evasion offence in accordance with section 10 of Tolling Regulations Part B.

4.5.5. Acoustic signals emitted by the REETS OBU

Service users must pay attention to the acoustic signals emitted by the REETS OBU while on the move. If any irregularities occur, the service user must go to the nearest GO point of sale, where a “local” Austrian GO-Box (see also section 4.8) can be obtained and comply with the obligation to make a retroactive payment (see also section 4.6).

In accordance with section 8.2.4.3 of Tolling Regulations Part B, the customer must observe the following acoustic signals emitted by the REETS OBU, each of which is associated with different obligations on the part of the service user:

- **ONE** brief acoustic signal (beep)
One beep means that toll payment is confirmed on the basis of the set category (number of axles) and the EURO emission class stored in the REETS OBU.
- **TWO** brief acoustic signals (beeps)
Two beeps means that toll payment is confirmed on the basis of the set category (number of axles) and the EURO emission class stored in the REETS OBU. The service provider will be happy to provide information on any service user obligations.
- **FOUR** short acoustic signals (beeps)
FOUR beeps means that the toll was not correctly paid. In this case, the service user is obliged in accordance with section 4.6 to go to a GO point of sale and to retroactively pay the toll for the relevant toll road sections. The service provider will give information about any action that the service user is required to take, such as the replacement of the REETS OBU.
- **NO** acoustic signal (no beep)
No beep means that no toll was paid. The only time when the customer is not obliged to retroactively pay the toll in accordance with section 4.6 of Tolling Regulations Part C is when the preconditions outlined in section 8.2.4.3.3 of Tolling Regulations Part B are met. The service provider will give information about any action that the service user is required to take, such as the replacement of the REETS OBU or the correct installation and operation of the REETS OBU.

4.6 Retroactive toll payment

In cases where tolls are not correctly paid, the service user must pay the toll retroactively in accordance with section 7 of Tolling Regulations Part B. Failure to do so can constitute a toll evasion offence (see section 10 of Tolling Regulations Part B). The following specific provisions apply when using REETS:

- The REETS OBU must not be presented at a GO point of sale. Instead, the vehicle declaration must be presented as a means of identification. Alternatively, the vehicle registration number and the country in which the vehicle was registered can be provided.
- It is not possible to obtain information about toll transactions at a GO point of sale.
- Retroactive payment of the toll at a GO point of sale is made only on request and in accordance with the information provided by the service user (in particular toll road sections used but not correctly paid for, number of axles, EURO emission class), as only the service user can determine when and where a toll was not paid.
- If the category used was too low, central retroactive payment can only be made by calling the ASFINAG Service Center by telephone.

- Retroactive payment is made directly to ASFINAG (in other words not via the service provider). For all details on the authorized means of payment, please refer to appendix 2 of the Tolling Regulations.
- No provisions are made for retroactive payment in conjunction with the EURO emission class because the service provider will already have checked the EURO emission class.

4.7 Responsibilities and services

4.7.1. Service provider

As a rule, the service user must always contact his or her service provider first. In the following cases, for example, the service user must always contact his or her service provider:

- registration with and de-registration from REETS
- handover and personalisation of the REETS OBU
- checking of the EURO emission class
- the issuing of vehicle declarations
- payment procedures, especially invoicing and information on invoices
- data changes, especially vehicle data, service user data, means of payment
- de-activation and re-activation of the REETS OBU (e.g. in the event of the loss of the REETS OBU)
- maintenance, repair, and exchange services relating to the REETS OBU
- information regarding the sale or rental of vehicles using REETS

4.7.2. GO points of sale

GO points of sale are available to users of REETS in the following cases in particular:

- the retroactive payment of tolls (at staffed GO points of sale only)
- the issuing of “local” Austrian GO-Boxes;
- the return of “local” Austrian GO-Boxes.

Customers using REETS cannot use GO vending machines.

4.7.3. ASFINAG SERVICE CENTER (ASC)

Service users can call the ASC using one of the following numbers: 0800 400 12 400 (when calling from inside Austria) or +43 1 955 12 66 (when calling from outside Austria). The ASC is on hand to take central retroactive payments in the event of the use of the wrong category (number of axles) and to answer any general questions and issues relating to the Austrian toll system.

4.7.4. Special features

Service users cannot avail themselves of the functions of the SelfCare Portal and GO vending machines or the services they provide. Nor shall ASFINAG Maut Service GmbH provide service users with itemized toll information or collective invoice statements (in accordance with section 6 of Tolling Regulations Part B). The services available depend on the respective service provider. The service provider reserves the right to amend the type and scope of these services.

4.8 Using the 'local' Austrian GO-Box

If toll payment in Austria is not possible with the REETS OBU, the service user is obliged to use a 'local' Austrian GO-Box in accordance with Tolling Regulations Part B. The 'local' Austrian GO-Box can be obtained from any GO point of sale. Please note that once he or she has switched over to the 'local' Austrian GO-Box, the service user must retroactively pay any tolls accrued in accordance with section 4.6 of Tolling Regulations Part C or section 7 of Tolling Regulations Part B. This is a very important point because failure to do so (i.e. failure to pay accrued tolls after switching to a GO-Box) can constitute a toll evasion offence in accordance with section 10 of Tolling Regulations Part B.

In the following cases in particular, the toll in Austria must be paid using a 'local' Austrian GO-Box:

- if the REETS OBU experiences a technical failure;
- if the REETS OBU is de-activated;
- if the data on the vehicle declaration is not the same as the registration number attached to the vehicle, the country in which the vehicle was registered, and the OBU ID of the REETS OBU.

Please note that the simultaneous use of several on-board units that are authorized for electronic toll payment in Austria can lead to multiple toll payments. In this case, ASFINAG is not obliged to refund the excess toll payments.

5 EUROPEAN ELECTRONIC TOLL SERVICE (EETS)

In accordance with the decision of the EU Commission of 6 October 2009 'on the definition of the European Electronic Toll Service (EETS) and its technical elements (2009/750/EC)', the valid versions of both

- the general conditions set out in the EETS domain statement and
- the general contractual conditions for EETS service providers,

shall be published on the ASFINAG website (at www.asfinag.at).

Both of the aforementioned documents—both the published EETS Domain Statement and the general contractual conditions—are considered components of the European Electronic Toll Service.

-- Ends --

APPENDIX 1: VIGNETTE

1 VIGNETTE LAYOUT

1.1 Toll sticker

1.1.1 Annual toll sticker for vehicles up to 3.5 t



1.1.2 Two-month toll sticker for vehicles up to 3.5 t

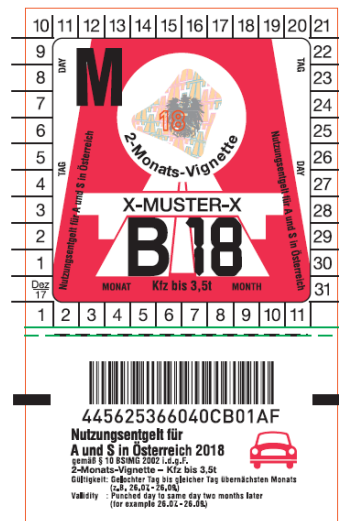
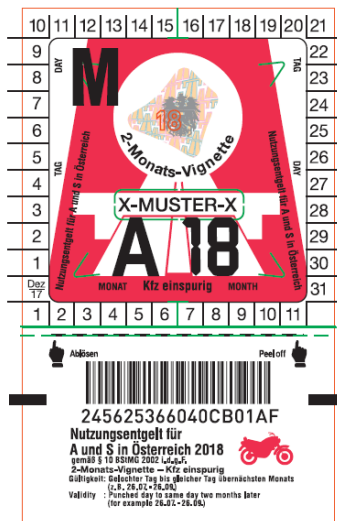

1.1.3 Ten-day toll sticker for vehicles up to 3.5 t



1.2 Digital Vignette for vehicles up to 3.5 t



2 VIGNETTE PRICES

Vignette prices are defined in an Ordinance issued by the Federal Minister of Transport, Innovation and Technology in consent with the Federal Minister of Finance. The vignette prices vary according to the type of vehicle and the duration of use; they include 20 % VAT. The following prices were defined in the Vignette Price Ordinance 2017, BGBl. (Federal Official Gazette) II Nr. 251/2017:

The price of an **annual vignette** amounts to

- **EUR 34.70** for single-track vehicles and
- **EUR 87.30** for twin-track vehicles with a maximum gross vehicle weight of up to 3.5 t.

The price of a **two-month vignette** (valid from 1 December 2017) for the use of toll roads amounts to

- **EUR 13.10** for single-track vehicles and
- **EUR 26.20** for twin-track vehicles with a maximum gross vehicle weight of up to 3.5 t.

The price of a **ten-day toll vignette** (valid from 1 December 2017) for the use of toll roads amounts to

- **EUR 5.20** for single-track vehicles and
- **EUR 9.00** for twin-track vehicles with a maximum gross vehicle weight of up to 3.5 t.

3 OVERVIEW OF SALES OUTLETS

3.1 Sales Outlets for toll stickers

Austria Automobile clubs: ARBÖ, ÖAMTC
„Trafiken“ tobacconist's shops
Petrol stations

Abroad Automobile clubs
Petrol stations

Authorised sales outlets are marked with the toll sticker symbol.

3.2 Obtaining a digital vignette

It is possible to obtain the digital vignette:

- in the ASFINAG **webshop** on www.asfinag.at
- by using the **ASFINAG App** "Unterwegs"
- at (freely accessible) **vending machines**

APPENDIX 2

METHODS AND MEANS OF PAYMENT

1 THE TIME-RELATED TOLL (TOLLING REGULATIONS PART A I)

1.1 Payment at a toll enforcement officer

When apprehended by a toll enforcement officer, drivers may pay the substitute toll using the following methods and means of payment:

| |
|--|
| <p><u>Cash payment</u></p>  |
| <p><u>Debit cards</u></p>   |
| <p><u>Credit cards</u></p>     |
| <p><u>Petrol cards</u></p>        |

1.2 Payment of a digital vignette on the Internet or App

The payment of a digital vignette on the Internet or APP “Unterwegs” is possible with the following methods and means of payment:



1.3 Payment at a vending machine

The payment of a digital vignette at a vending machine is possible with the following methods and means of payment:



2 ROAD SECTION TOLL (TOLLING REGULATIONS Part A II)

2.1 Payment at toll points

The following methods and means of payment are accepted for payment of the section toll at toll points:

| |
|--|
| <p><u>Cash payment</u></p>  |
| <p><u>Debit cards</u></p>   |
| <p><u>Credit cards</u></p>     |
| <p><u>Petrol cards</u></p>        |

Cash payment of section tolls is only permissible in euros.

2.2 Payment of the digital section toll on the Internet and App

The following methods and means of payment for digital section toll are accepted for payment on the Internet and APP “Unterwegs”:

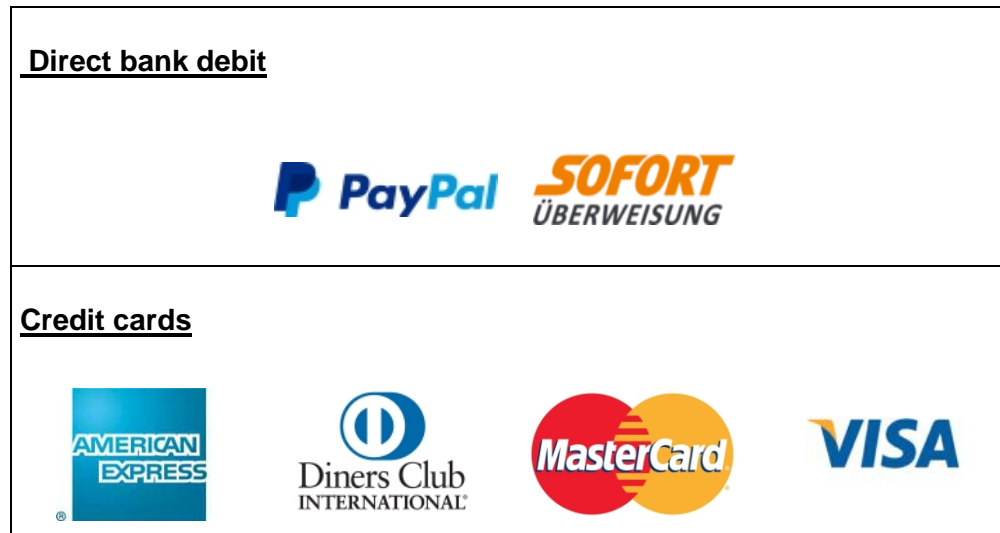

2.3 Payment at a vending machine

The payment of a digital section toll at a vending machine is possible with the following methods and means of payment:

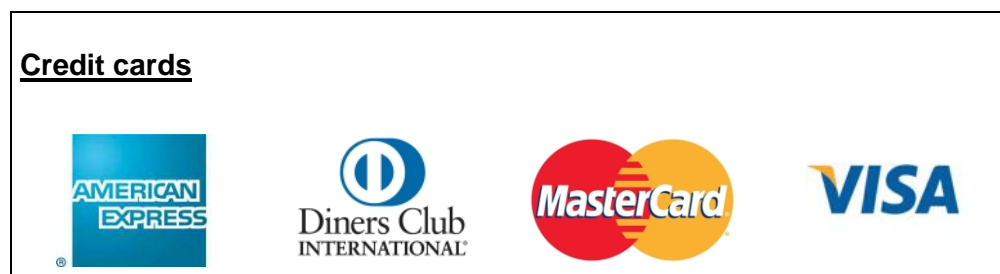

3 THE DISTANCE-RELATED TOLL (TOLLING REGULATIONS PART B and PART C)

3.1 The post-pay procedure

3.1.1 The following means of payment are accepted for the post-pay procedure throughout the sales network:

| | GO points of sale | GO VENDING MACHINES |
|---|-------------------|---------------------|
| <u>Credit cards</u> | | |
|  | OK | — |
|  | OK | — |
|  | OK *) | — |
|  | - | - |
|  | OK *) | — |

*) Only cards issued in Austria (see section 3.4.1. a) of this appendix).







| | GO points of sale | GO VENDING MACHINES |
|--|--|--|
| <p><u>Petrol cards</u></p>             | <p>OK</p> <p>OK</p> <p>OK</p> <p>OK</p> <p>OK</p> <p>-</p> <p>OK</p> <p>OK</p> <p>OK</p> <p>OK</p> <p>OK</p> <p>OK</p> | <p>OK</p> <p>OK</p> <p>OK</p> <p>OK</p> <p>OK</p> <p>-</p> <p>OK</p> <p>OK</p> <p>OK</p> <p>OK</p> <p>OK</p> |

| | GO points of sale | GO VENDING MACHINES |
|---|-------------------|---------------------|
|  | OK | OK |
|  | - | - |
|  | OK | OK |
|  | OK | OK |
|  | OK | OK |
|  | OK | OK |
|  | - | - |
|  | OK | OK |











3.1.2 The following means of payment are accepted by ASFINAG CUSTOMER SERVICE and on the Internet

3.1.2.1 Acceptance in conjunction with GO-Boxes

Only changes in the means of payment and written orders relating to the post-pay procedure are accepted by the ASFINAG CUSTOMER SERVICE and via Internet. Moreover, specific payments outlined in section 3.4.6 can be made via the Internet.

| | Change of the means of payment | | GO-Box orders | Payment via Internet ¹⁾ | |
|---|--------------------------------|------------|---------------|------------------------------------|---------------------------|
| | Internet | In writing | In writing | using a card that can be entered | using a post-pay contract |
| <p><u>Direct payment</u></p>  | - | OK | OK | - | OK |
| <p><u>Credit cards</u></p>  | OK | OK | OK | OK | OK |
|  | OK | OK | OK | OK | OK |
|  | OK | OK | OK | OK | OK |
|  | OK | OK | OK | OK | OK |
|  | OK | OK | OK | OK | OK |

¹⁾ For information on using debit and credit cards to make payments on the Internet, please refer to section 3.4.6 of this appendix.

| | Change of the means of payment | | GO-Box orders | Payment via Internet ¹⁾ | |
|---|--------------------------------|------------|---------------|------------------------------------|---------------------------|
| | Internet | In writing | In writing | using a card that can be entered | using a post-pay contract |
| <u>Petrol cards</u> | | | | | |
|  | OK | OK | OK | OK | OK |
|  | OK | OK | OK | OK | OK |
|  | OK | OK | OK | OK | OK |
|  | OK | OK | OK | OK | OK |
|  | OK | OK | OK | - | OK |
|  | OK | OK | OK | OK | OK |
|  | OK | OK | OK | OK | OK |
|  | OK | OK | OK | OK | OK |
|  | OK | OK | OK | OK | OK |
|  | OK | OK | OK | OK | OK |

¹⁾For information about using petrol cards to make payments on the Internet, please refer to section 3.4.6 of this appendix.

| | Change of the means of payment | | GO-Box orders | Payment via Internet ¹⁾ | |
|---|--------------------------------|------------|---------------|------------------------------------|---------------------------|
| | Internet | In writing | In writing | using a card that can be entered | using a post-pay contract |
| Petrol cards | | | | | |
|  | OK | OK | OK | OK | OK |
|  | OK | OK | OK | OK | OK |
|  | OK | OK | OK | - | OK |
|  | OK | OK | OK | OK | OK |
|  | OK | OK | OK | OK | OK |
|  | OK | OK | OK | OK | OK |
|  | OK | OK | OK | OK | OK |
|  | OK | OK | OK | OK | OK |
|  | OK | OK | OK | OK | OK |







¹⁾For information on using petrol cards to make payments on the Internet, please refer to section 3.4.6 of this appendix.

| | Change of the means of payment | | GO-Box orders | Payment via Internet ¹⁾ | |
|---|--------------------------------|------------|---------------|------------------------------------|---------------------------|
| | Internet | In writing | In writing | using a card that can be entered | using a post-pay contract |
| <p><u>Petrol cards</u></p>  | OK | OK | OK | OK | OK |





¹⁾ For information on using petrol cards to make payments on the Internet, please refer to section 3.4.6 of this appendix.

3.1.2.2 Acceptance in conjunction with TRIPON or Emotach on-board units









Contracts relating to TRIPON or Emotach on-board units may only be concluded by correctly completing the form and posting, faxing, or sending it by e-mail to the ASFINAG CUSTOMER SERVICE or via the SelfCare Portal.

| | Change of the means of payment | | TRIPON or Emotach orders | Payment via Internet ¹⁾ | |
|---|--------------------------------|------------|--------------------------|------------------------------------|---------------------------|
| | Internet | In writing | In writing | using a card that can be entered | using a post-pay contract |
| Direct payment  | - | OK | OK | - | OK |
| Credit cards      | OK | OK | - | OK | OK |
| | OK | OK | - | OK | OK |
| | OK | OK | - | OK | OK |
| | OK | OK | - | OK | OK |



¹⁾ For information on using debit and credit cards to make payments on the Internet, please refer to section 3.4.6 of this appendix.

| | Change of the means of payment | | TRIPON or Emotach orders | Payment via Internet ¹⁾ | |
|---|--------------------------------|------------|--------------------------|------------------------------------|---------------------------|
| | Internet | In writing | In writing | using a card that can be entered | using a post-pay contract |
| <u>Petrol cards</u> | | | | | |
|  DIESEL 24 | OK | OK | OK | OK | OK |
|  | OK | OK | OK | OK | OK |
|  | OK | OK | OK | OK | OK |
|  | OK | OK | OK | OK | OK |
|  | OK | OK | OK | - | OK |
|  | OK | OK | OK | OK | OK |
|  | OK | OK | OK | OK | OK |
|  | OK | OK | OK | OK | OK |
|  | OK | OK | OK | OK | OK |
|  | OK | OK | OK | OK | OK |

¹⁾For information on using petrol cards to make payments on the Internet, please refer to section 3.4.6 of this appendix.

| | Change of the means of payment | | TRIPON or Emotach orders | Payment via Internet ¹⁾ | |
|---|--------------------------------|------------|--------------------------|------------------------------------|---------------------------|
| | Internet | In writing | In writing | using a card that can be entered | using a post-pay contract |
| <u>Petrol cards</u> | | | | | |
|  | OK | OK | OK | OK | OK |
|  | OK | OK | OK | OK | OK |
|  | OK | OK | OK | - | OK |
|  | OK | OK | OK | OK | OK |
|  | OK | OK | OK | OK | OK |
|  | OK | OK | OK | OK | OK |
|  | OK | OK | OK | OK | OK |
|  | OK | OK | OK | OK | OK |







¹⁾ For information on using petrol cards to make payments on the Internet, please refer to section 3.4.6 of this appendix.

| | Change of the means of payment | | TRIPON or Emotach orders | Payment via Internet ¹⁾ | |
|---|--------------------------------|------------|--------------------------|------------------------------------|---------------------------|
| | Internet | In writing | In writing | using a card that can be entered | using a post-pay contract |
| <u>Petrol cards</u> | | | | | |
|  | OK | OK | OK | OK | OK |
|  | OK | OK | OK | OK | OK |

¹⁾ For information on using petrol cards to make payments on the Internet, please refer to section 3.4.6 of this appendix.

3.1.2.3 Acceptance in conjunction with TOLL2GO on-board units

Contracts relating to TOLL2GO on-board units can only be concluded via the SelfCare Portal.

| | Change of the means of payment | | TOLL2GO orders | | Payment via Internet ¹⁾ | |
|---|--------------------------------|------------|----------------------------------|---------------------------|------------------------------------|---------------------------|
| | Internet | In writing | using a card that can be entered | using a post-pay contract | using a card that can be entered | using a post-pay contract |
| Direct payment  | - | OK | - | OK | - | OK |
| Credit cards      | OK | OK | OK | OK | OK | OK |



¹⁾ For information on using debit and credit cards to make payments on the Internet, please refer to section 3.4.6 of this appendix.

| | Change of the means of payment | | TOLL2GO orders | | Payment via Internet ¹⁾ | |
|---|--------------------------------|------------|----------------------------------|---------------------------|------------------------------------|---------------------------|
| | Internet | In writing | using a card that can be entered | using a post-pay contract | using a card that can be entered | using a post-pay contract |
| <u>Petrol cards</u> | | | | | | |
|  | OK | OK | OK | OK | OK | OK |
|  | OK | OK | OK | OK | OK | OK |
|  | OK | OK | OK | OK | OK | OK |
|  | OK | OK | OK | OK | OK | OK |
|  | OK | OK | OK | OK | - | OK |
|  | OK | OK | OK | OK | OK | OK |
|  | OK | OK | OK | OK | OK | OK |
|  | OK | OK | OK | OK | OK | OK |
|  | OK | OK | OK | OK | OK | OK |
|  | OK | OK | OK | OK | OK | OK |

¹⁾ For information on using petrol cards to make payments on the Internet, please refer to section 3.4.6 of this appendix.

| | Change of the means of payment | | TOLL2GO orders | | Payment via Internet ¹⁾ | |
|---|--------------------------------|------------|----------------------------------|---------------------------|------------------------------------|---------------------------|
| | Internet | In writing | using a card that can be entered | using a post-pay contract | using a card that can be entered | using a post-pay contract |
| <u>Petrol cards</u> | | | | | | |
|  | OK | OK | OK | OK | OK | OK |
|  | OK | OK | OK | OK | OK | OK |
|  | OK | OK | OK | OK | - | OK |
|  | OK | OK | OK | OK | - | OK |
|  | OK | OK | OK | OK | OK | OK |
|  | OK | OK | OK | OK | OK | OK |
|  | OK | OK | OK | OK | OK | OK |
|  | OK | OK | OK | OK | OK | OK |

¹⁾For information on using petrol cards to make payments on the Internet, please refer to section 3.4.6 of this appendix.

| | Change of the means of payment | | TOLL2GO orders | | Payment via Internet ¹⁾ | |
|---|--------------------------------|------------|----------------------------------|---------------------------|------------------------------------|---------------------------|
| | Internet | In writing | using a card that can be entered | using a post-pay contract | using a card that can be entered | using a post-pay contract |
| <p><u>Petrol cards</u></p>  | OK | OK | OK | OK | OK | OK |
|  | OK | OK | OK | OK | OK | OK |

¹⁾ For information on using petrol cards to make payments on the Internet, please refer to section 3.4.6 of this appendix.

3.1.2.4 Acceptance in conjunction with the EasyGo+ service



Contracts relating to the EasyGo+ service can only be concluded via one of the EasyGo Toll Service Providers offering the EasyGo+ service.

| | OBU orders at TSP ¹⁾ | Payment at the point of sale | Payment via Internet |
|---|---------------------------------|------------------------------|----------------------|
|  BroBizz A/S | OK | - | - |

1) TSP....Toll Service Provider

3.1.2.5 Acceptance in conjunction with the REETS service

Contracts relating to the REETS service can only be concluded via one of the Toll Service Providers offering the REETS service.

| | Type of the accepted OBU | OBU orders at the TSP ¹⁾ | Payment at the point of sale | Payment via Internet |
|--|----------------------------------|-------------------------------------|------------------------------|----------------------|
|  DKV Euro Service GmbH & Co. KG | OBU-4021-01K | OK | - | - |
|  Telepass S.p.A. | TLPDM03-HE or ETOLL2ST-1HE | OK | - | - |

1) TSP ... Toll Service Provider

3.2 The pre-pay procedure

3.2.1 The following methods and means of payment are accepted for the pre-pay procedure:

| | |
|---|--|
| <p><u>Cash payment</u></p>  <p>Cash payment is only permissible in euros. Exceptions are made at the distribution outlets in Hungary, where payment in Forints is accepted. Five hundred euro (€500) notes are not accepted at GO VENDING MACHINES.</p> | |
| <p><u>Debit cards</u></p>  | |
| <p><u>Credit cards</u></p>  | |
| <p><u>Petrol cards</u></p>  | |







3.2.2 Payment via Internet

For information on other payment options for the pre-pay procedure, please refer to section 3.4.6. The authorised methods and means of payment for the pre-pay procedure are listed in section 3.1.2 in the category 'Payment via Internet' and the column 'Payment using a card that can be entered'.

3.3 Retroactive payment of the toll and substitute toll and provision of security deposits (when apprehended by a toll enforcement officer)

When apprehended by a toll enforcement officer, the following means of payment are accepted for all payments (retroactive payment of the toll and substitute toll and provision of security deposits).

| | Retroactive toll payment | Substitute toll | Security deposits |
|--|--------------------------|-----------------|-------------------|
| <p><u>Cash payment</u></p>  | OK | OK | OK |
| <p><u>Debit cards</u></p>   | OK | OK | OK |
| <p><u>Credit cards</u></p>     | OK | OK | OK |

| | Retroactive toll payment | Substitute toll | Security deposits |
|---|--------------------------|-----------------|-------------------|
| <u>Petrol cards</u> | | | |
|  | OK | OK | - |
|  | OK | OK | - |
|  | OK | OK | - |
|  | OK | OK | - |
|  | OK | OK | - |
|  | OK | OK | - |

3.4 Special issues regarding payment transactions

3.4.1 Special issues regarding payment in the post-pay procedure

a) Payment using credit cards that have been issued abroad (i.e. outside Austria)

Only Mastercard and VISA credit cards with the following issuer codes (i.e. the first four to six digits of the card number) are accepted:

| <u>VISA</u> | <u>Mastercard</u> |
|-------------|-------------------|
| 400302 | 5266xx |
| 410364 | 532953 |
| 410366 | 532954 |
| 410367 | 543315 |
| 410368 | 544271 |
| 422093 | 544990 |
| 422210 | 547318 |
| 422211 | 544895 |
| 423801 | 549252 |
| 427313 | 552171 |
| 427323 | |
| 427798 | |
| 427799 | |
| 431337 | |
| 437898 | |
| 443877 | |
| 448470 | |
| 454818 | |
| 454825 | |
| 454828 | |
| 456848 | |
| 460090 | |
| 466555 | |
| 490473 | |
| 490474 | |
| 498537 | |

This broadly corresponds to VISA and Mastercard credit cards that were issued in Austria.

The limited acceptance of Mastercard, and VISA cards is based on the fact that these international card organisations cannot give ASFINAG payment guarantees.

American Express and Diners Club cards, on the other hand, are accepted as a means of payment for the post-pay procedure regardless of the country in which the cards were issued.

b) Petrol card issuer approval for payment in the post-pay procedure

Like credit card issuers, petrol card issuers must also give ASFINAG payment guarantees and therefore reserve the right to decide which of their customers may be authorised for the post-pay procedure. Authorised customers (card numbers) are put on a so-called 'White List'. While some petrol card issuers approve all valid cards for the post-pay procedure and automatically put card holders on the 'White List', others check the creditworthiness of each individual customer (card number) before approving them for this procedure. Questions regarding approval should be directed to the appropriate petrol card issuer.

c) Concluding post-pay contracts at staffed GO points of sale

All means of payment that are approved for the post-pay procedure in section 3.1.1 can be used to conclude a post-pay contract at staffed GO points of sale. The contract is brought about by two actions: the issuing of the GO-Box and the payment of the processing fee for system access.

d) Concluding post-pay contracts at un-staffed GO points of sale (GO VENDING MACHINES)

Post-pay contracts can also be concluded at un-staffed GO points of sale (i.e. at GO VENDING MACHINES). All approved means of payment listed in section 3.1.1 can be used for this purpose.

These cards can also be used to change a means of payment or to change the type of contract from pre-pay to post-pay for issued GO-Boxes at un-staffed GO points of sale. In other words, if a post-pay contract was concluded and a specific card was indicated and accepted as the means of payment, only the cards listed above can be used to switch to one of these cards in the post-pay procedure at an un-staffed GO point of sale.

e) Concluding post-pay contracts in writing

ASFINAG Maut Service GmbH accepts written orders for GO-Boxes or other authorised on-board units for the post-pay procedure, whereby an indication of the desired method or means of payment must be provided together with the other information at the time the order is placed. A written order for a GO-Box for which payment will be made using a petrol card must be sent to the card company.

Regardless of the means of payment used, written orders for a TRIPON or Emotach on-board unit must be sent directly to ASFINAG (either via the SelfCare Portal or the relevant forms; for more information, please refer to section 1.3 of Tolling Regulations Part C).

f) Deactivating GO-Boxes or other authorised on-board units for the post-pay procedure

If a card company no longer provides a payment guarantee, the GO-Box or other authorised on-board unit must be deactivated and the user is no longer permitted to use the toll road network. If the toll road network is used in conjunction with a deactivated GO-Box or other authorised on-board unit, no toll transactions are made and no tolls are collected (see also section 10 of Tolling Regulations Part B). The driver will be alerted to this fact by an acoustic signal. The driver must go to the nearest GO point of sale, use a valid means of payment to reverse the deactivation of his/her GO-Box or other authorised on-board unit, and pay the tolls that have accrued since deactivation in accordance with the provisions of section 7 of Tolling Regulations Part B. Failure to comply with this provision constitutes a toll evasion offence (see section 10 of Tolling Regulations Part B).

If a petrol card issuer adds a card to its 'black list', this card will be blocked for the post-pay procedure.

If payment is made using credit cards, the GO-Box or other authorised on-board unit is deactivated if the card issuer rejects the payment transaction. This happens in particular when

- a credit limit has been exceeded,
- the credit card company's bills have not been paid by the card holder,
- the card has been cancelled as a result of theft/loss,
- the card or the account no longer exists.

g) Direct payment to ASFINAG via GO Direkt

GO Direkt allows customers with post-pay contracts to pay their tolls directly to ASFINAG. To this end, customers receive an invoice from ASFINAG.

Since 1 July 2009, ASFINAG has been entitled to offer GO Direkt customers an annual welcome and loyalty bonus of 0.3% of the toll charges accrued and paid over the course of a billing period of twelve months at the end of the billing period. Starting on 1 July 2009, the billing period used as a basis for the calculation of the annual welcome and loyalty bonus shall be the previous twelve months, starting on the day the contract was concluded. A welcome and loyalty bonus will only be awarded if the contractual relationship still exists with the GO Direkt customer on the last day of the twelve-month period (appointed date) and has existed for the entire duration of that period. This means that for existing customers, the welcome and loyalty bonus will be paid out for the first time on 1 July 2010 (appointed date). For new customers, on the other hand, the appointed date shall be determined by the day and year in which the contract was concluded. The bonus will be awarded as follows: ASFINAG will deduct the relevant bonus amount from the first invoice to be sent after the appointed date, whereby the amount of the bonus awarded will be indicated on the invoice.

3.4.2 Exceptions to the authorisation of petrol cards

If the cards issued by a petrol card issuer are authorised as a means of payment for the pre-pay and post-pay procedures, all valid cards that have not been blocked are accepted for payment.

In exceptional cases, petrol card issuers have agreed specific limitations with ASFINAG. For example, the following cards may not be authorised:

- cards that were issued in a specific country
- cards with specific issuer code (the issuer code is made up of the first four to six digits in the card number)

Card holders can obtain information on exact provisions directly from the issuer of their petrol card.

3.4.3 Methods and means of payment for the administrative fee for LOST GO-Boxes

The administrative fee for LOST GO-Boxes can be paid at GO points of sale using the methods and means of payment that are valid for the pre-pay procedure. The only exception to this provision is the EuroShell card, which cannot be used to pay the administrative fee for the GO-Box.

In addition, in the case of post-pay contracts involving GO-Boxes that have been deactivated, but not as a result of a blocking of the means of payment, it is possible to pay the administrative fee at GO points of sale using the means of payment registered for the respective post-pay contract. This means that a corresponding means of payment must not be presented at GO points of sale.

3.4.4 Settling accounts for several vehicles using one card

If payment is made using Maestro or credit cards, accounts can be settled for several vehicles (GO-Boxes) using one card regardless of the payment procedure chosen (pre-pay or post-pay procedure).

The rules vary for payment with petrol cards. Some petrol card issuers only permit accounts to be settled for one vehicle per card; others for several vehicles. Card holders can obtain information on exact provisions directly from the issuer of their petrol card.

3.4.5 Retroactive payment and retroactive billing of the toll at a GO point of sale

The methods and means of payment that are valid for the pre-pay procedure (see section 3.2 of this appendix) can be used for retroactive payment and retroactive billing of tolls in accordance with section 7 of Tolling Regulations Part B at GO points of sale.

Restrictions may apply to the retroactive payment and retroactive billing of tolls at GO VENDING MACHINES (see Tolling Regulations Part C).

In addition, in the case of post-pay contracts involving GO-Boxes that have been deactivated, but not as a result of the blocking of the means of payment, it is possible to make retroactive payment at GO points of sale using the means of payment registered for the contract. This means that a corresponding means of payment must not be presented at GO points of sale.

3.4.6 Payment via the Internet

The means of payment listed in the category 'Payment via Internet' in section 3.1.2 can be used to make payments via the SelfCare Portal.

- For the means of payment marked 'OK' in the 'Payment using a post-pay contract' column, the means of payment already entered in the system is used to make payment in the post-pay procedure, as long as this means of payment has not been blocked.
- Means of payment that are marked 'OK' in the 'Payment using a card that can be entered' column can be used as a means of payment as long as the customer provides the card number and the expiry date (and the card security code for credit cards) provided that such transactions are authorised by the card issuer.

The means of payment listed above are non-binding and are for information purposes only. If methods or means of payment are rejected despite being listed as valid means of payment, this could be the result of conditions imposed by the card issuer, e.g. a limit on the sum that can be paid in this kind of transaction. For detailed information on the provisions that apply, card holders are requested to contact the issuer of their card directly.

Central retroactive payment

Under the conditions specified in section 7.2 of Tolling Regulations Part B, customers who have set the wrong category or toll rate group for their vehicles (i.e. a category or toll rate group that is too low) can pay the non-paid toll retroactively via the SelfCare Portal.

APPENDIX 3a: APPLICATION FOR EXEMPTION – time-related toll (vignette)

info@asfinag.at

Fax: +43/ 1 955 12 77

APPLICATION NUMBER: xxxxxxxxxxxxxxxx (will be provided by ASFINAG)

APPLICATION

in accordance with section 5(2) BStMG in conjunction with section 1.3.3.2.2 of Tolling Regulations Part A I regarding temporary exemption from the mandatory toll

I/we herewith apply for a temporary exemption from the mandatory toll in view of the following circumstances “.....” and provide the following true and accurate information:

1. REASON FOR AND DURATION OF THE TOLL EXEMPTION

Date of the single trip:
 Time of the trip: to
 Route (junctions):
 Details of freight:

2. INFORMATION ON THE VEHICLE

Nationality/vehicle registration number: /
 Vehicle type:

3. INFORMATION ON THE REGISTERED OWNER

Name (company name)/address: /
 Contact person:
 Tel./Fax/e-mail: / /

4. INFORMATION ON THE AID ORGANISATION

Name/address: /
 Contact person:
 Tel./Fax/e-mail: / /
 Client for the aid transport (first name and surname/company name and address):

The fully completed and signed application form (original) containing the issued application number must be carried in the vehicle for the duration of the trip that is exempt from the mandatory toll and must be presented on request as evidence of exemption approval. Upon leaving the vehicle, the driver must ensure that the issued exemption application form is placed inside the windscreen in such a way that the entitlement of use (especially the reason for and duration of the toll exemption and the vehicle registration number) can easily be seen and inspected from outside the vehicle.

.....
 (signature of the registered owner)

.....
 (signature of the aid organisations/client)

[Location], on

**APPENDIX 3b - APPLICATION FOR EXEMPTION
for vehicles with a max. GVW of more than 3.5 t**

APPLICATION NUMBER: xxxxxxxxxxxxxxxx (will be provided by ASFINAG)

APPLICATION

in accordance with section 5(2) BStMG in conjunction with section 3.3.2. of Tolling Regulations Part B regarding temporary exemption from the mandatory toll

I/we herewith apply for a temporary exemption from the mandatory toll in view of the following circumstances "....." and provide the following true and accurate information:

1. REASON FOR AND DURATION OF THE TOLL EXEMPTION

Date of the single trip:
 Time of the trip: to
 Route (junctions):
 Details of freight:

2. INFORMATION ON THE VEHICLE

Nationality/vehicle registration number: /
 Type of vehicle/number of axles: /
 GO-Box number for the post-pay procedure (where applicable):

3. INFORMATION ON THE REGISTERED OWNER

First name and surname (company name)/address: /
 Contact person:
 Tel./Fax/e-mail: / /

4. INFORMATION ON THE AID ORGANISATION

Name/address: /
 Contact person:
 Tel./Fax/e-mail: / /
 Client for the aid transport (first name and surname/company name and address):

The fully completed and signed application form (original) containing the issued application number must be carried in the vehicle for the duration of the trip that is exempt from the mandatory toll and must be presented on request as evidence of exemption approval. Exemption from the toll requires that the GO-Box used for the pre-pay procedure is deactivated by the user for the duration of the trip that is exempt from the mandatory toll (either by removing the GO-Box from the vehicle or by properly attaching the shield cover). If the GO-Box for pre-pay procedures is not deactivated, a toll transaction or toll charging process will automatically be completed. If this happens, the collected tolls will not be refunded.

.....
(signature of the registered owner)

.....
(signature of the aid organisation/client)

[Location], on

APPENDIX 3c: APPLICATION FOR EXEMPTION – section toll

info@asfinag.at

Fax: +43/ 1 955 12 77

APPLICATION NUMBER: xxxxxxxxxxxxxxxx (will be provided by ASFINAG)

APPLICATION

in accordance with section 5(2) BStMG in conjunction with section 2.3.2 of Tolling Regulations Part All regarding temporary exemption from the mandatory toll

I/we herewith apply for a temporary exemption from the mandatory toll in view of the following circumstances “.....” and provide the following true and accurate information:

1. REASON FOR AND DURATION OF THE TOLL EXEMPTION

Date of the single trip
 Time of the trip: to
 Route: (please mark with an X) single / return
 Toll points (please mark with an X): A13/ S16/ A10 / A11 / A9
 Details of freight:

2. INFORMATION ON THE VEHICLE

Nationality/vehicle registration number: /
 Vehicle type:

3. INFORMATION ON THE REGISTERED OWNER

Name (company name)/address: /
 Contact person:
 Tel./Fax/e-mail: /

4. INFORMATION ON THE AID ORGANISATION

Name/address: /
 Contact person:
 Tel./Fax/e-mail: /
 Client for the aid transport (first name and surname/company name and address):

The fully completed and signed application form (original) containing the issued application number must be handed over at the relevant toll point. If a return journey is to be made, a copy of the original application form must be made and handed over at the toll point on the return journey.

.....
(signature of the registered owner)

.....
(signature of the aid organisations/client)

[Location], on

APPENDIX 3d: APPLICATION FOR A RESIDENT'S CARD FOR THE A13

| | |
|--|-------|
| Applicant | |
| Name: | |
| Address: | |
| Data of the vehicle registration: (Applicant must be the registered owner!) | |
| Registration number: | |
| Resident's Card | |
| <input type="checkbox"/> Car <input type="checkbox"/> Motorcycle <input type="checkbox"/> EUR 40.50 (20% VAT incl.) without vignette credit (no possession of an annual vignette) <input type="checkbox"/> EUR 0.00 with a vignette credit (verified possession of an annual vignette) | |
| Requirements | |
| <p>Residents living in one of the following townships (principal residence required):</p> <p>Ellbögen, Gries am Brenner, Gschnitz, Matrei am Brenner, Mühlbachl, Navis, Obernberg am Brenner, Patsch, Pfons, Schmirn, Steinach am Brenner, Trins, and Vals im Wipptal, Schönberg, Mieders, Fulpmes, Telfes, and Neustift im Stubaital</p> <p>Furthermore it will be checked whether all requirements are met in accordance with the current tolling regulations.</p> | |
| Declaration | |
| <p>By signing this application, I hereby declare that the above-mentioned vehicle is for private use only and is not used for commercial purposes.</p> <p>I also hereby acknowledge that use of the resident's card for commercial purposes, for other unauthorised purposes, or the provision of incorrect data will not only result in the immediate confiscation of the resident's card, but will also require the payment of the toll accrued for the use of the toll road for the single trip.</p> <p>The right to assert all claims resulting from an unjustified use of the resident's card is expressly reserved.</p> <p>Signature Place, Date:</p> <p><small>of the applicant</small></p> | |
| Necessary documents: | |
| <ul style="list-style-type: none"> - Copy of the vehicle registration document - Copy of a confirmation of the principal residence (e.g. registration card), if the above-mentioned township is not stated in the vehicle's registration document - Provision of a valid lower section (allonge) in the original resp. product-ID of a valid annual vignette for the same license plate number | |
| Internal completion note | |
| Checked by supervisor: | Date: |
| Double-checked by official: | Date: |

| Road | Toll road section from | Toll road section to | EURO 0 Cat 2 | | | | | | EURO 0 Cat 3 | | | | | | EURO 0 Cat 4 | | | | | |
|------|----------------------------|----------------------------|--------------|--------|--------|-------|--------|--------|--------------|--------|--------|-------|--------|--------|--------------|--------|--------|-------|--------|--------|
| | | | Unit Price | | | | | | Unit Price | | | | | | Unit Price | | | | | |
| | | | Day | | | Night | | | Day | | | Night | | | Day | | | Night | | |
| Sum | Air | Noise | Sum | Air | Noise | Sum | Air | Noise | Sum | Air | Noise | Sum | Air | Noise | Sum | Air | Noise | | | |
| A01- | Wien Auhof | Preßbaum | 3,11 | 0,5572 | 0,0098 | 3,11 | 0,5572 | 0,0153 | 4,36 | 0,7801 | 0,0224 | 4,37 | 0,7801 | 0,0352 | 6,25 | 0,8915 | 0,0283 | 6,27 | 0,8915 | 0,0444 |
| A01- | Preßbaum | KN Steinhäusl | 1,75 | 0,3149 | 0,0055 | 1,76 | 0,3149 | 0,0087 | 2,46 | 0,4408 | 0,0127 | 2,47 | 0,4408 | 0,0199 | 3,53 | 0,5038 | 0,0160 | 3,54 | 0,5038 | 0,0251 |
| A01- | KN Steinhäusl | Altlangbach | 1,03 | 0,1851 | 0,0032 | 1,03 | 0,1851 | 0,0051 | 1,45 | 0,2592 | 0,0075 | 1,45 | 0,2592 | 0,0117 | 2,08 | 0,2962 | 0,0094 | 2,08 | 0,2962 | 0,0148 |
| A01- | Altlangbach | St. Christoph | 1,23 | 0,2208 | 0,0039 | 1,23 | 0,2208 | 0,0061 | 1,73 | 0,3091 | 0,0089 | 1,73 | 0,3091 | 0,0140 | 2,48 | 0,3532 | 0,0112 | 2,48 | 0,3532 | 0,0176 |
| A01- | St. Christoph | Böheimkirchen | 1,48 | 0,2648 | 0,0046 | 1,48 | 0,2648 | 0,0073 | 2,07 | 0,3707 | 0,0107 | 2,08 | 0,3707 | 0,0167 | 2,97 | 0,4236 | 0,0134 | 2,98 | 0,4236 | 0,0211 |
| A01- | Böheimkirchen | KN St. Pölten | 1,44 | 0,2590 | 0,0045 | 1,45 | 0,2590 | 0,0071 | 2,02 | 0,3626 | 0,0104 | 2,03 | 0,3626 | 0,0164 | 2,91 | 0,4144 | 0,0131 | 2,91 | 0,4144 | 0,0207 |
| A01- | KN St. Pölten | St. Pölten Süd | 1,02 | 0,1837 | 0,0032 | 1,03 | 0,1837 | 0,0051 | 1,44 | 0,2572 | 0,0074 | 1,44 | 0,2572 | 0,0116 | 2,06 | 0,2940 | 0,0093 | 2,07 | 0,2940 | 0,0147 |
| A01- | St. Pölten Süd | Loosdorf | 3,55 | 0,6371 | 0,0111 | 3,56 | 0,6371 | 0,0175 | 4,98 | 0,8920 | 0,0256 | 5,00 | 0,8920 | 0,0403 | 7,15 | 1,0194 | 0,0323 | 7,16 | 1,0194 | 0,0508 |
| A01- | Loosdorf | Melk | 1,30 | 0,2334 | 0,0041 | 1,30 | 0,2334 | 0,0064 | 1,82 | 0,3268 | 0,0094 | 1,83 | 0,3268 | 0,0148 | 2,62 | 0,3735 | 0,0118 | 2,63 | 0,3735 | 0,0186 |
| A01- | Melk | Pöchlarn | 2,31 | 0,4138 | 0,0072 | 2,31 | 0,4138 | 0,0114 | 3,24 | 0,5794 | 0,0167 | 3,24 | 0,5794 | 0,0262 | 4,64 | 0,6621 | 0,0210 | 4,65 | 0,6621 | 0,0330 |
| A01- | Pöchlarn | Ybbs Wieselburg | 2,13 | 0,3819 | 0,0067 | 2,13 | 0,3819 | 0,0105 | 2,99 | 0,5346 | 0,0154 | 2,99 | 0,5346 | 0,0242 | 4,28 | 0,6110 | 0,0194 | 4,29 | 0,6110 | 0,0305 |
| A01- | Ybbs Wieselburg | Amstetten Ost | 1,91 | 0,3432 | 0,0060 | 1,92 | 0,3432 | 0,0094 | 2,68 | 0,4804 | 0,0138 | 2,69 | 0,4804 | 0,0217 | 3,85 | 0,5491 | 0,0174 | 3,86 | 0,5491 | 0,0274 |
| A01- | Amstetten Ost | Amstetten West | 3,01 | 0,5398 | 0,0094 | 3,01 | 0,5398 | 0,0148 | 4,22 | 0,7557 | 0,0217 | 4,23 | 0,7557 | 0,0341 | 6,05 | 0,8636 | 0,0274 | 6,07 | 0,8636 | 0,0430 |
| A01- | Amstetten West | Oed | 2,11 | 0,3790 | 0,0066 | 2,12 | 0,3790 | 0,0104 | 2,96 | 0,5305 | 0,0153 | 2,97 | 0,5305 | 0,0240 | 4,25 | 0,6063 | 0,0192 | 4,26 | 0,6063 | 0,0302 |
| A01- | Oed | Haag | 2,28 | 0,4090 | 0,0072 | 2,28 | 0,4090 | 0,0112 | 3,20 | 0,5726 | 0,0165 | 3,21 | 0,5726 | 0,0259 | 4,59 | 0,6544 | 0,0208 | 4,60 | 0,6544 | 0,0326 |
| A01- | Haag | St. Valentin | 2,03 | 0,3642 | 0,0064 | 2,03 | 0,3642 | 0,0100 | 2,85 | 0,5099 | 0,0147 | 2,86 | 0,5099 | 0,0230 | 4,09 | 0,5827 | 0,0185 | 4,10 | 0,5827 | 0,0290 |
| A01- | St. Valentin | Enns Steyr | 0,86 | 0,1544 | 0,0027 | 0,86 | 0,1544 | 0,0042 | 1,21 | 0,2162 | 0,0062 | 1,21 | 0,2162 | 0,0098 | 1,73 | 0,2470 | 0,0078 | 1,74 | 0,2470 | 0,0123 |
| A01- | Enns Steyr | Enns West | 0,67 | 0,1198 | 0,0021 | 0,67 | 0,1198 | 0,0033 | 0,94 | 0,1677 | 0,0048 | 0,94 | 0,1677 | 0,0076 | 1,34 | 0,1916 | 0,0061 | 1,35 | 0,1916 | 0,0096 |
| A01- | Enns West | Asten St Florian | 0,52 | 0,0930 | 0,0016 | 0,52 | 0,0930 | 0,0026 | 0,73 | 0,1302 | 0,0037 | 0,73 | 0,1302 | 0,0059 | 1,04 | 0,1488 | 0,0047 | 1,05 | 0,1488 | 0,0074 |
| A01- | Asten St Florian | KN Linz | 1,98 | 0,3562 | 0,0062 | 1,99 | 0,3562 | 0,0098 | 2,79 | 0,4986 | 0,0143 | 2,79 | 0,4986 | 0,0225 | 3,99 | 0,5699 | 0,0181 | 4,01 | 0,5699 | 0,0284 |
| A01- | KN Linz | Ansfelden | 0,33 | 0,0600 | 0,0011 | 0,34 | 0,0600 | 0,0017 | 0,47 | 0,0841 | 0,0024 | 0,47 | 0,0841 | 0,0038 | 0,67 | 0,0961 | 0,0030 | 0,68 | 0,0961 | 0,0048 |
| A01- | Ansfelden | Traun | 0,74 | 0,1329 | 0,0023 | 0,74 | 0,1329 | 0,0037 | 1,04 | 0,1860 | 0,0053 | 1,04 | 0,1860 | 0,0084 | 1,49 | 0,2126 | 0,0067 | 1,49 | 0,2126 | 0,0106 |
| A01- | Traun | KN A1/A25 Passau Wels | 0,35 | 0,0625 | 0,0011 | 0,35 | 0,0625 | 0,0017 | 0,49 | 0,0875 | 0,0025 | 0,49 | 0,0875 | 0,0040 | 0,70 | 0,1000 | 0,0032 | 0,70 | 0,1000 | 0,0050 |
| A01- | KN A1/A25 Passau Wels | Allhaming | 1,61 | 0,2883 | 0,0050 | 1,61 | 0,2883 | 0,0079 | 2,25 | 0,4036 | 0,0116 | 2,26 | 0,4036 | 0,0182 | 3,23 | 0,4612 | 0,0146 | 3,24 | 0,4612 | 0,0230 |
| A01- | Allhaming | Sattledt | 2,68 | 0,4810 | 0,0084 | 2,69 | 0,4810 | 0,0132 | 3,76 | 0,6733 | 0,0194 | 3,77 | 0,6733 | 0,0304 | 5,39 | 0,7695 | 0,0244 | 5,41 | 0,7695 | 0,0384 |
| A01- | Sattledt | KN Voralpenkreuz | 0,34 | 0,0605 | 0,0011 | 0,34 | 0,0605 | 0,0017 | 0,47 | 0,0847 | 0,0024 | 0,47 | 0,0847 | 0,0038 | 0,68 | 0,0968 | 0,0031 | 0,68 | 0,0968 | 0,0048 |
| A01- | KN Voralpenkreuz | Eberstalzell | 0,97 | 0,1741 | 0,0030 | 0,97 | 0,1741 | 0,0048 | 1,36 | 0,2438 | 0,0070 | 1,37 | 0,2438 | 0,0110 | 1,95 | 0,2786 | 0,0088 | 1,96 | 0,2786 | 0,0139 |
| A01- | Eberstalzell | Vorchdorf | 1,46 | 0,2626 | 0,0046 | 1,47 | 0,2626 | 0,0072 | 2,05 | 0,3676 | 0,0106 | 2,06 | 0,3676 | 0,0166 | 2,94 | 0,4201 | 0,0133 | 2,95 | 0,4201 | 0,0209 |
| A01- | Vorchdorf | Laakirchen Ost | 1,28 | 0,2300 | 0,0040 | 1,28 | 0,2300 | 0,0063 | 1,80 | 0,3221 | 0,0093 | 1,80 | 0,3221 | 0,0146 | 2,58 | 0,3681 | 0,0117 | 2,59 | 0,3681 | 0,0183 |
| A01- | Laakirchen Ost | Laakirchen West | 0,81 | 0,1448 | 0,0025 | 0,81 | 0,1448 | 0,0040 | 1,13 | 0,2027 | 0,0058 | 1,14 | 0,2027 | 0,0092 | 1,62 | 0,2317 | 0,0073 | 1,63 | 0,2317 | 0,0115 |
| A01- | Laakirchen West | Regau | 1,58 | 0,2838 | 0,0050 | 1,58 | 0,2838 | 0,0078 | 2,22 | 0,3974 | 0,0114 | 2,23 | 0,3974 | 0,0180 | 3,18 | 0,4541 | 0,0144 | 3,19 | 0,4541 | 0,0226 |
| A01- | Regau | Schörfling | 2,08 | 0,3730 | 0,0065 | 2,08 | 0,3730 | 0,0103 | 2,92 | 0,5221 | 0,0150 | 2,92 | 0,5221 | 0,0236 | 4,18 | 0,5967 | 0,0189 | 4,19 | 0,5967 | 0,0297 |
| A01- | Schörfling | Seewalchen | 0,32 | 0,0578 | 0,0010 | 0,32 | 0,0578 | 0,0016 | 0,45 | 0,0809 | 0,0023 | 0,45 | 0,0809 | 0,0037 | 0,65 | 0,0925 | 0,0029 | 0,65 | 0,0925 | 0,0046 |
| A01- | Seewalchen | St. Georgen | 1,88 | 0,3381 | 0,0059 | 1,89 | 0,3381 | 0,0093 | 2,64 | 0,4733 | 0,0136 | 2,65 | 0,4733 | 0,0214 | 3,79 | 0,5409 | 0,0172 | 3,80 | 0,5409 | 0,0270 |
| A01- | St. Georgen | Oberwang | 2,51 | 0,4508 | 0,0079 | 2,52 | 0,4508 | 0,0124 | 3,52 | 0,6311 | 0,0181 | 3,53 | 0,6311 | 0,0285 | 5,06 | 0,7213 | 0,0229 | 5,07 | 0,7213 | 0,0360 |
| A01- | Oberwang | Mondsee | 2,31 | 0,4149 | 0,0073 | 2,32 | 0,4149 | 0,0114 | 3,24 | 0,5809 | 0,0167 | 3,25 | 0,5809 | 0,0262 | 4,65 | 0,6639 | 0,0211 | 4,67 | 0,6639 | 0,0331 |
| A01- | Mondsee | Thalgau | 2,13 | 0,3825 | 0,0067 | 2,14 | 0,3825 | 0,0105 | 2,99 | 0,5355 | 0,0154 | 3,00 | 0,5355 | 0,0242 | 4,29 | 0,6120 | 0,0194 | 4,30 | 0,6120 | 0,0305 |
| A01- | Thalgau | Wallersee | 1,62 | 0,2915 | 0,0051 | 1,63 | 0,2915 | 0,0080 | 2,28 | 0,4081 | 0,0117 | 2,29 | 0,4081 | 0,0184 | 3,27 | 0,4664 | 0,0148 | 3,28 | 0,4664 | 0,0232 |
| A01- | Wallersee | Salzburg Nord | 1,57 | 0,2822 | 0,0049 | 1,58 | 0,2822 | 0,0078 | 2,21 | 0,3950 | 0,0114 | 2,21 | 0,3950 | 0,0178 | 3,16 | 0,4515 | 0,0143 | 3,17 | 0,4515 | 0,0225 |
| A01- | Salzburg Nord | Salzburg Bergheim-West | 0,35 | 0,0636 | 0,0011 | 0,36 | 0,0636 | 0,0017 | 0,50 | 0,0890 | 0,0026 | 0,50 | 0,0890 | 0,0040 | 0,71 | 0,1018 | 0,0032 | 0,72 | 0,1018 | 0,0051 |
| A01- | Salzburg Bergheim-West | Messe | 0,17 | 0,0304 | 0,0005 | 0,17 | 0,0304 | 0,0008 | 0,24 | 0,0426 | 0,0012 | 0,24 | 0,0426 | 0,0019 | 0,34 | 0,0487 | 0,0015 | 0,34 | 0,0487 | 0,0024 |
| A01- | Messe | Salzburg Mitte Freilassing | 0,23 | 0,0405 | 0,0007 | 0,23 | 0,0405 | 0,0011 | 0,32 | 0,0567 | 0,0016 | 0,32 | 0,0567 | 0,0026 | 0,45 | 0,0648 | 0,0021 | 0,46 | 0,0648 | 0,0032 |
| A01- | Salzburg Mitte Freilassing | Kleßheim | 0,28 | 0,0497 | 0,0009 | 0,28 | 0,0497 | 0,0014 | 0,39 | 0,0696 | 0,0020 | 0,39 | 0,0696 | 0,0031 | 0,56 | 0,0796 | 0,0025 | 0,56 | 0,0796 | 0,0040 |
| A01- | Kleßheim | Siezenheim | 0,38 | 0,0689 | 0,0012 | 0,38 | 0,0689 | 0,0019 | 0,54 | 0,0965 | 0,0028 | 0,54 | 0,0965 | 0,0044 | 0,77 | 0,1103 | 0,0035 | 0,78 | 0,1103 | 0,0055 |
| A01- | Siezenheim | Flughafen | 0,19 | 0,0346 | 0,0006 | 0,19 | 0,0346 | 0,0010 | 0,27 | 0,0485 | 0,0014 | 0,27 | 0,0485 | 0,0022 | 0,39 | 0,0554 | 0,0018 | 0,39 | 0,0554 | 0,0028 |
| A01- | Flughafen | Wals Salzburg West | 0,24 | 0,0424 | 0,0007 | 0,24 | 0,0424 | 0,0012 | 0,33 | 0,0593 | 0,0017 | 0,33 | 0,0593 | 0,0027 | 0,48 | 0,0678 | 0,0021 | 0,48 | 0,0678 | 0,0034 |
| A01- | Wals Salzburg West | KN Salzburg | 0,35 | 0,0634 | 0,0011 | 0,35 | 0,0634 | 0,0017 | 0,50 | 0,0888 | 0,0026 | 0,50 | 0,0888 | 0,0040 | 0,71 | 0,1014 | 0,0032 | 0,71 | 0,1014 | 0,0051 |
| A01- | KN Salzburg | Staatsgrenze Walsberg | 0,60 | 0,1077 | 0,0019 | 0,60 | 0,1077 | 0,0030 | 0,84 | 0,1508 | 0,0043 | 0,84 | 0,1508 | 0,0068 | 1,21 | 0,1724 | 0,0055 | 1,21 | 0,1724 | 0,0086 |
| A02- | KN Wien Inzersdorf | KN Vösendorf | 0,75 | 0,1348 | 0,0024 | 0,75 | 0,1348 | 0,0037 | 1,05 | 0,1887 | 0,0054 | 1,06 | 0,1887 | 0,0085 | 1,51 | 0,2157 | 0,0068 | 1,52 | 0,2157 | 0,0108 |
| A02- | KN Vösendorf | Mödling | 0,51 | 0,0916 | 0,0016 | 0,51 | 0,0916 | 0,0025 | 0,72 | 0,1283 | 0,0037 | 0,72 | 0,1283 | 0,0058 | 1,03 | 0,1466 | | | | |

| | | | | | | | | | | | | | | | | | | | | |
|------|----------------------------|----------------------------|------|--------|--------|------|--------|--------|------|--------|--------|------|--------|--------|------|--------|--------|------|--------|--------|
| A02- | Ilz Fürstenfeld | Sinabelkirchen | 2,50 | 0,4493 | 0,0079 | 2,51 | 0,4493 | 0,0124 | 3,51 | 0,6290 | 0,0181 | 3,52 | 0,6290 | 0,0284 | 5,04 | 0,7189 | 0,0228 | 5,05 | 0,7189 | 0,0358 |
| A02- | Sinabelkirchen | Gleisdorf Süd | 1,65 | 0,2960 | 0,0052 | 1,65 | 0,2960 | 0,0081 | 2,31 | 0,4144 | 0,0119 | 2,32 | 0,4144 | 0,0187 | 3,32 | 0,4736 | 0,0150 | 3,33 | 0,4736 | 0,0236 |
| A02- | Gleisdorf Süd | Gleisdorf West | 0,72 | 0,1285 | 0,0022 | 0,72 | 0,1285 | 0,0035 | 1,00 | 0,1799 | 0,0052 | 1,01 | 0,1799 | 0,0081 | 1,44 | 0,2056 | 0,0065 | 1,44 | 0,2056 | 0,0102 |
| A02- | Gleisdorf West | Laßnitzhöhe | 1,88 | 0,3366 | 0,0059 | 1,88 | 0,3366 | 0,0093 | 2,63 | 0,4713 | 0,0135 | 2,64 | 0,4713 | 0,0213 | 3,78 | 0,5386 | 0,0171 | 3,79 | 0,5386 | 0,0268 |
| A02- | Laßnitzhöhe | KN Graz Ost | 2,35 | 0,4212 | 0,0074 | 2,35 | 0,4212 | 0,0116 | 3,29 | 0,5896 | 0,0170 | 3,30 | 0,5896 | 0,0266 | 4,72 | 0,6739 | 0,0214 | 4,74 | 0,6739 | 0,0336 |
| A02- | KN Graz Ost | Graz Feldkirchen Flughafen | 0,84 | 0,1515 | 0,0027 | 0,85 | 0,1515 | 0,0042 | 1,18 | 0,2121 | 0,0061 | 1,19 | 0,2121 | 0,0096 | 1,70 | 0,2424 | 0,0077 | 1,70 | 0,2424 | 0,0121 |
| A02- | Graz Feldkirchen Flughafen | KN Graz West | 0,57 | 0,1014 | 0,0018 | 0,57 | 0,1014 | 0,0028 | 0,79 | 0,1420 | 0,0041 | 0,80 | 0,1420 | 0,0064 | 1,14 | 0,1623 | 0,0051 | 1,14 | 0,1623 | 0,0081 |
| A02- | KN Graz West | Unterpremstätten | 0,68 | 0,1220 | 0,0021 | 0,68 | 0,1220 | 0,0034 | 0,95 | 0,1707 | 0,0049 | 0,96 | 0,1707 | 0,0077 | 1,37 | 0,1951 | 0,0062 | 1,37 | 0,1951 | 0,0097 |
| A02- | Unterpremstätten | Lieboch | 1,06 | 0,1894 | 0,0033 | 1,06 | 0,1894 | 0,0052 | 1,48 | 0,2652 | 0,0076 | 1,49 | 0,2652 | 0,0120 | 2,12 | 0,3030 | 0,0096 | 2,13 | 0,3030 | 0,0151 |
| A02- | Lieboch | Mooskirchen | 1,46 | 0,2612 | 0,0046 | 1,46 | 0,2612 | 0,0072 | 2,04 | 0,3656 | 0,0105 | 2,05 | 0,3656 | 0,0165 | 2,93 | 0,4179 | 0,0133 | 2,94 | 0,4179 | 0,0208 |
| A02- | Mooskirchen | Steinberg | 1,51 | 0,2703 | 0,0047 | 1,51 | 0,2703 | 0,0074 | 2,11 | 0,3784 | 0,0109 | 2,12 | 0,3784 | 0,0171 | 3,03 | 0,4324 | 0,0137 | 3,04 | 0,4324 | 0,0216 |
| A02- | Steinberg | Modriach | 3,76 | 0,6756 | 0,0118 | 3,77 | 0,6756 | 0,0186 | 5,28 | 0,9458 | 0,0272 | 5,30 | 0,9458 | 0,0427 | 7,58 | 1,0810 | 0,0343 | 7,60 | 1,0810 | 0,0539 |
| A022 | KN Graz Ost | Puchwerk | 0,16 | 0,0283 | 0,0005 | 0,16 | 0,0283 | 0,0008 | 0,22 | 0,0396 | 0,0011 | 0,22 | 0,0396 | 0,0018 | 0,32 | 0,0453 | 0,0014 | 0,32 | 0,0453 | 0,0023 |
| A022 | Puchwerk | Graz Raaba | 0,23 | 0,0405 | 0,0007 | 0,23 | 0,0405 | 0,0011 | 0,32 | 0,0567 | 0,0016 | 0,32 | 0,0567 | 0,0026 | 0,45 | 0,0648 | 0,0021 | 0,46 | 0,0648 | 0,0032 |
| A022 | Graz Raaba | Graz Sternäckerweg | 0,33 | 0,0588 | 0,0010 | 0,33 | 0,0588 | 0,0016 | 0,46 | 0,0824 | 0,0024 | 0,46 | 0,0824 | 0,0037 | 0,66 | 0,0941 | 0,0030 | 0,66 | 0,0941 | 0,0047 |
| A02- | Modriach | Packsattel | 1,73 | 0,3112 | 0,0054 | 1,74 | 0,3112 | 0,0086 | 2,43 | 0,4356 | 0,0125 | 2,44 | 0,4356 | 0,0197 | 3,49 | 0,4979 | 0,0158 | 3,50 | 0,4979 | 0,0248 |
| A02- | Packsattel | Bad St. Leonhard | 2,11 | 0,3784 | 0,0066 | 2,11 | 0,3784 | 0,0104 | 2,96 | 0,5297 | 0,0152 | 2,97 | 0,5297 | 0,0239 | 4,24 | 0,6054 | 0,0192 | 4,25 | 0,6054 | 0,0302 |
| A02- | Bad St. Leonhard | Wolfsberg Nord | 2,48 | 0,4446 | 0,0078 | 2,48 | 0,4446 | 0,0122 | 3,48 | 0,6225 | 0,0179 | 3,49 | 0,6225 | 0,0281 | 4,99 | 0,7114 | 0,0226 | 5,00 | 0,7114 | 0,0355 |
| A02- | Wolfsberg Nord | Wolfsberg Süd | 0,70 | 0,1264 | 0,0022 | 0,71 | 0,1264 | 0,0035 | 0,99 | 0,1770 | 0,0051 | 0,99 | 0,1770 | 0,0080 | 1,42 | 0,2022 | 0,0064 | 1,42 | 0,2022 | 0,0101 |
| A02- | Wolfsberg Süd | St. Andrä | 2,07 | 0,3714 | 0,0065 | 2,07 | 0,3714 | 0,0102 | 2,90 | 0,5200 | 0,0149 | 2,91 | 0,5200 | 0,0235 | 4,17 | 0,5942 | 0,0188 | 4,18 | 0,5942 | 0,0296 |
| A02- | St. Andrä | Griffen | 2,01 | 0,3610 | 0,0063 | 2,02 | 0,3610 | 0,0099 | 2,82 | 0,5054 | 0,0145 | 2,83 | 0,5054 | 0,0228 | 4,05 | 0,5776 | 0,0183 | 4,06 | 0,5776 | 0,0288 |
| A02- | Griffen | Völkermarkt Ost | 1,02 | 0,1824 | 0,0032 | 1,02 | 0,1824 | 0,0050 | 1,43 | 0,2553 | 0,0073 | 1,43 | 0,2553 | 0,0115 | 2,05 | 0,2918 | 0,0093 | 2,05 | 0,2918 | 0,0145 |
| A02- | Völkermarkt Ost | Völkermarkt West | 2,35 | 0,4208 | 0,0074 | 2,35 | 0,4208 | 0,0116 | 3,29 | 0,5892 | 0,0169 | 3,30 | 0,5892 | 0,0266 | 4,72 | 0,6733 | 0,0214 | 4,73 | 0,6733 | 0,0336 |
| A02- | Völkermarkt West | Grafenstein | 2,24 | 0,4028 | 0,0070 | 2,25 | 0,4028 | 0,0111 | 3,15 | 0,5640 | 0,0162 | 3,16 | 0,5640 | 0,0255 | 4,52 | 0,6445 | 0,0204 | 4,53 | 0,6445 | 0,0321 |
| A02- | Grafenstein | Klagenfurt Ost | 1,44 | 0,2584 | 0,0045 | 1,44 | 0,2584 | 0,0071 | 2,02 | 0,3618 | 0,0104 | 2,03 | 0,3618 | 0,0163 | 2,90 | 0,4134 | 0,0131 | 2,91 | 0,4134 | 0,0206 |
| A02- | Klagenfurt Ost | Klagenfurt Flughafen | 0,73 | 0,1307 | 0,0023 | 0,73 | 0,1307 | 0,0036 | 1,02 | 0,1830 | 0,0053 | 1,02 | 0,1830 | 0,0083 | 1,47 | 0,2092 | 0,0066 | 1,47 | 0,2092 | 0,0104 |
| A02- | Klagenfurt Flughafen | Klagenfurt Nord | 0,81 | 0,1448 | 0,0025 | 0,81 | 0,1448 | 0,0040 | 1,13 | 0,2027 | 0,0058 | 1,14 | 0,2027 | 0,0092 | 1,62 | 0,2317 | 0,0073 | 1,63 | 0,2317 | 0,0115 |
| A02- | Klagenfurt Nord | Klagenfurt West | 1,40 | 0,2504 | 0,0044 | 1,40 | 0,2504 | 0,0069 | 1,96 | 0,3505 | 0,0101 | 1,96 | 0,3505 | 0,0158 | 2,81 | 0,4006 | 0,0127 | 2,82 | 0,4006 | 0,0200 |
| A02- | Klagenfurt West | Kruppendorf West | 0,56 | 0,0998 | 0,0017 | 0,56 | 0,0998 | 0,0027 | 0,78 | 0,1397 | 0,0040 | 0,78 | 0,1397 | 0,0063 | 1,12 | 0,1597 | 0,0051 | 1,12 | 0,1597 | 0,0080 |
| A02- | Kruppendorf West | Pörschach Ost | 0,67 | 0,1202 | 0,0021 | 0,67 | 0,1202 | 0,0033 | 0,94 | 0,1683 | 0,0048 | 0,94 | 0,1683 | 0,0076 | 1,35 | 0,1923 | 0,0061 | 1,35 | 0,1923 | 0,0096 |
| A02- | Pörschach Ost | Pörschach West | 1,04 | 0,1872 | 0,0033 | 1,04 | 0,1872 | 0,0051 | 1,46 | 0,2620 | 0,0075 | 1,47 | 0,2620 | 0,0118 | 2,10 | 0,2995 | 0,0095 | 2,10 | 0,2995 | 0,0149 |
| A02- | Pörschach West | Velden Ost | 0,77 | 0,1387 | 0,0024 | 0,77 | 0,1387 | 0,0038 | 1,08 | 0,1942 | 0,0056 | 1,09 | 0,1942 | 0,0088 | 1,56 | 0,2219 | 0,0070 | 1,56 | 0,2219 | 0,0111 |
| A02- | Velden Ost | Velden West | 0,83 | 0,1493 | 0,0026 | 0,83 | 0,1493 | 0,0041 | 1,17 | 0,2090 | 0,0060 | 1,17 | 0,2090 | 0,0094 | 1,67 | 0,2389 | 0,0076 | 1,68 | 0,2389 | 0,0119 |
| A02- | Velden West | Wernberg | 1,38 | 0,2468 | 0,0043 | 1,38 | 0,2468 | 0,0068 | 1,93 | 0,3455 | 0,0099 | 1,93 | 0,3455 | 0,0156 | 2,77 | 0,3949 | 0,0125 | 2,78 | 0,3949 | 0,0197 |
| A02- | Wernberg | KN Villach | 0,73 | 0,1312 | 0,0023 | 0,73 | 0,1312 | 0,0036 | 1,03 | 0,1837 | 0,0053 | 1,03 | 0,1837 | 0,0083 | 1,47 | 0,2099 | 0,0067 | 1,48 | 0,2099 | 0,0105 |
| A02- | KN Villach | Villach Faaker See | 0,57 | 0,1020 | 0,0018 | 0,57 | 0,1020 | 0,0028 | 0,80 | 0,1428 | 0,0041 | 0,80 | 0,1428 | 0,0065 | 1,14 | 0,1632 | 0,0052 | 1,15 | 0,1632 | 0,0081 |
| A02- | Villach Faaker See | Villach Warmbad | 1,30 | 0,2330 | 0,0041 | 1,30 | 0,2330 | 0,0064 | 1,82 | 0,3262 | 0,0094 | 1,83 | 0,3262 | 0,0147 | 2,61 | 0,3728 | 0,0118 | 2,62 | 0,3728 | 0,0186 |
| A02- | Villach Warmbad | Hermagor | 2,35 | 0,4224 | 0,0074 | 2,36 | 0,4224 | 0,0116 | 3,30 | 0,5914 | 0,0170 | 3,31 | 0,5914 | 0,0267 | 4,74 | 0,6758 | 0,0214 | 4,75 | 0,6758 | 0,0337 |
| A02- | Hermagor | Arnoldstein | 0,56 | 0,1006 | 0,0018 | 0,56 | 0,1006 | 0,0028 | 0,79 | 0,1408 | 0,0040 | 0,79 | 0,1408 | 0,0064 | 1,13 | 0,1610 | 0,0051 | 1,13 | 0,1610 | 0,0080 |
| A02- | Arnoldstein | Staatsgrenze Arnoldstein | 0,86 | 0,1542 | 0,0027 | 0,86 | 0,1542 | 0,0042 | 1,21 | 0,2159 | 0,0062 | 1,21 | 0,2159 | 0,0098 | 1,73 | 0,2468 | 0,0078 | 1,73 | 0,2468 | 0,0123 |
| A03- | KN Guntramsdorf | Münchendorf/Achau | 0,22 | 0,0400 | 0,0007 | 0,22 | 0,0400 | 0,0011 | 0,31 | 0,0561 | 0,0016 | 0,31 | 0,0561 | 0,0025 | 0,45 | 0,0641 | 0,0020 | 0,45 | 0,0641 | 0,0032 |
| A03- | Münchendorf/Achau | Ebreichsdorf Nord | 0,94 | 0,1686 | 0,0029 | 0,94 | 0,1686 | 0,0046 | 1,32 | 0,2360 | 0,0068 | 1,32 | 0,2360 | 0,0107 | 1,89 | 0,2697 | 0,0086 | 1,90 | 0,2697 | 0,0134 |
| A03- | Ebreichsdorf Nord | Ebreichsdorf West | 0,77 | 0,1376 | 0,0024 | 0,77 | 0,1376 | 0,0038 | 1,08 | 0,1926 | 0,0055 | 1,08 | 0,1926 | 0,0087 | 1,54 | 0,2202 | 0,0070 | 1,55 | 0,2202 | 0,0110 |
| A03- | Ebreichsdorf West | Pottendorf | 1,01 | 0,1805 | 0,0032 | 1,01 | 0,1805 | 0,0050 | 1,41 | 0,2527 | 0,0073 | 1,42 | 0,2527 | 0,0114 | 2,02 | 0,2888 | 0,0092 | 2,03 | 0,2888 | 0,0144 |
| A03- | Pottendorf | Hornstein | 1,65 | 0,2964 | 0,0052 | 1,65 | 0,2964 | 0,0082 | 2,32 | 0,4150 | 0,0119 | 2,32 | 0,4150 | 0,0187 | 3,32 | 0,4742 | 0,0150 | 3,33 | 0,4742 | 0,0236 |
| A03- | Hornstein | Müllendorf | 1,08 | 0,1942 | 0,0034 | 1,08 | 0,1942 | 0,0053 | 1,52 | 0,2719 | 0,0078 | 1,52 | 0,2719 | 0,0123 | 2,18 | 0,3108 | 0,0099 | 2,18 | 0,3108 | 0,0155 |
| A03- | Müllendorf | KN Eisenstadt | 0,90 | 0,1624 | 0,0028 | 0,91 | 0,1624 | 0,0045 | 1,27 | 0,2273 | 0,0065 | 1,27 | 0,2273 | 0,0103 | 1,82 | 0,2598 | 0,0082 | 1,83 | 0,2598 | 0,0129 |
| A031 | KN Eisenstadt | Siegersdorf | 0,71 | 0,1280 | 0,0022 | 0,71 | 0,1280 | 0,0035 | 1,00 | 0,1792 | 0,0052 | 1,00 | 0,1792 | 0,0081 | 1,44 | 0,2048 | 0,0065 | 1,44 | 0,2048 | 0,0102 |
| A041 | Stadionbrücke | KN Wien Prater | 0,13 | 0,0235 | 0,0004 | 0,13 | 0,0235 | 0,0006 | 0,18 | 0,0329 | 0,0009 | 0,18 | 0,0329 | 0,0015 | 0,26 | 0,0376 | 0,0012 | 0,26 | 0,0376 | 0,0019 |
| A04- | KN Wien Prater | Alt-Simmering | 0,29 | 0,0512 | 0,0009 | 0,29 | 0,0512 | 0,0014 | 0,40 | 0,0717 | 0,0021 | 0,40 | 0,0717 | 0,0032 | 0,57 | 0,0820 | 0,0026 | 0,58 | 0,0820 | 0,0041 |
| A04- | Alt-Simmering | Wien 7. Haidequerstraße | 0,22 | 0,0387 | 0,0007 | 0,22 | 0,0387 | 0,0011 | 0,30 | 0,0542 | 0,0016 | 0,30 | 0,0542 | 0,0024 | 0,43 | 0,0619 | 0,0020 | 0,44 | 0,0619 | 0,0031 |
| A04- | Wien 7. Haidequerstraße | Wien Simmeringer Haide | 0,40 | 0,0723 | 0,0013 | 0,40 | 0,0723 | 0,0020 | 0,57 | 0,1012 | 0,0029 | 0,57 | 0,1012 | 0,0046 | 0,81 | 0,1156 | 0,0037 | 0,81 | 0,1156 | 0,0058 |
| A04- | Wien Simmeringer Haide | KN Schwechat | 0,81 | 0,1456 | 0,0025 | 0,81 | 0,1456 | 0,0040 | 1,14 | 0,2038 | 0,0059 | 1,14 | 0,2038 | 0,0092 | 1,63 | 0,2330 | 0,0074 | 1,64 | 0,2330 | 0,0116 |
| A04- | KN Schwechat | Flughafen Wien Schwechat | 1,17 | 0,2103 | 0,0037 | 1,17 | 0,2103 | 0,0058 | 1,64 | 0,2944 | 0,0085 | 1,65 | 0,2944 | 0,0133 | 2,36 | 0,3365 | 0,0107 | 2,37 | 0,3365 | 0,0168 |
| A04- | Flughafen Wien Schwechat | Fischamend | 1,31 | 0,2355 | 0,0041 | 1,31 | 0,2355 | 0,0065 | 1,84 | 0,3297 | 0,0095 | 1,85 | 0,3297 | 0,0149 | 2,64 | 0,3768 | 0,0120 | 2,65 | 0,3768 | 0,0188 |
| A04- | Fischamend | Bruck/Leitha West | 2,88 | 0,5164 | 0,0090 | 2,88 | 0,5164 | 0,0142 | 4,04 | 0,7230 | 0,0208 | 4,05 | 0,7230 | 0,0327 | 5,79 | 0,8263 | 0,0262 | 5,81 | 0,8263 | 0,0412 |
| A04- | Bruck/Leitha West | Bruck/Leitha Ost | 0,96 | 0,1715 | 0,0030 | 0,96 | 0,1715 | 0,0047 | 1,34 | 0,2401 | 0,0069 | 1 | | | | | | | | |

| | | | | | | | | | | | | | | | | | | | | |
|------|----------------------------------|----------------------------------|-------|--------|--------|-------|--------|--------|-------|--------|--------|-------|--------|--------|-------|--------|--------|-------|--------|--------|
| A05- | Großkrut | Poysdorf Nord | 1,53 | 0,2741 | 0,0048 | 1,53 | 0,2741 | 0,0075 | 2,14 | 0,3838 | 0,0110 | 2,15 | 0,3838 | 0,0173 | 3,07 | 0,4386 | 0,0139 | 3,08 | 0,4386 | 0,0219 |
| A06- | KN Bruckneudorf | Potzneusiedl | 1,94 | 0,3472 | 0,0061 | 1,94 | 0,3472 | 0,0095 | 2,71 | 0,4861 | 0,0140 | 2,72 | 0,4861 | 0,0220 | 3,89 | 0,5556 | 0,0176 | 3,90 | 0,5556 | 0,0277 |
| A06- | Potzneusiedl | Gattendorf | 0,84 | 0,1507 | 0,0026 | 0,84 | 0,1507 | 0,0041 | 1,18 | 0,2110 | 0,0061 | 1,18 | 0,2110 | 0,0095 | 1,69 | 0,2412 | 0,0076 | 1,69 | 0,2412 | 0,0120 |
| A06- | Gattendorf | Kittsee | 1,40 | 0,2521 | 0,0044 | 1,41 | 0,2521 | 0,0069 | 1,97 | 0,3529 | 0,0101 | 1,98 | 0,3529 | 0,0159 | 2,83 | 0,4033 | 0,0128 | 2,83 | 0,4033 | 0,0201 |
| A06- | Kittsee | Staatsgrenze Kittsee | 0,71 | 0,1280 | 0,0022 | 0,71 | 0,1280 | 0,0035 | 1,00 | 0,1793 | 0,0052 | 1,00 | 0,1793 | 0,0081 | 1,44 | 0,2049 | 0,0065 | 1,44 | 0,2049 | 0,0102 |
| A07- | KN Linz | Linz Franzosenhausweg | 0,50 | 0,0903 | 0,0016 | 0,50 | 0,0903 | 0,0025 | 0,71 | 0,1264 | 0,0036 | 0,71 | 0,1264 | 0,0057 | 1,01 | 0,1445 | 0,0046 | 1,02 | 0,1445 | 0,0072 |
| A07- | Linz Franzosenhausweg | Linz Salzburger Straße Neue Welt | 0,44 | 0,0788 | 0,0014 | 0,44 | 0,0788 | 0,0022 | 0,62 | 0,1104 | 0,0032 | 0,62 | 0,1104 | 0,0050 | 0,88 | 0,1261 | 0,0040 | 0,89 | 0,1261 | 0,0063 |
| A07- | Linz Salzburger Straße Neue Welt | Muldenstraße Bindermichl | 0,30 | 0,0547 | 0,0010 | 0,31 | 0,0547 | 0,0015 | 0,43 | 0,0766 | 0,0022 | 0,43 | 0,0766 | 0,0035 | 0,61 | 0,0876 | 0,0028 | 0,62 | 0,0876 | 0,0044 |
| A07- | Muldenstraße Bindermichl | Leonding Linz Zentrum | 0,15 | 0,0266 | 0,0005 | 0,15 | 0,0266 | 0,0007 | 0,21 | 0,0372 | 0,0011 | 0,21 | 0,0372 | 0,0017 | 0,30 | 0,0425 | 0,0013 | 0,30 | 0,0425 | 0,0021 |
| A07- | Leonding Linz Zentrum | Linz Wiener Straße | 0,21 | 0,0374 | 0,0007 | 0,21 | 0,0374 | 0,0010 | 0,29 | 0,0523 | 0,0015 | 0,29 | 0,0523 | 0,0024 | 0,42 | 0,0598 | 0,0019 | 0,42 | 0,0598 | 0,0030 |
| A07- | Linz Wiener Straße | Linz VOEST | 0,19 | 0,0347 | 0,0006 | 0,19 | 0,0347 | 0,0010 | 0,27 | 0,0486 | 0,0014 | 0,27 | 0,0486 | 0,0022 | 0,39 | 0,0556 | 0,0018 | 0,39 | 0,0556 | 0,0028 |
| A07- | Linz VOEST | Linz Industriezeile | 0,15 | 0,0272 | 0,0005 | 0,15 | 0,0272 | 0,0007 | 0,21 | 0,0381 | 0,0011 | 0,21 | 0,0381 | 0,0017 | 0,31 | 0,0436 | 0,0014 | 0,31 | 0,0436 | 0,0022 |
| A07- | Linz Industriezeile | Linz Prinz Eugenstraße | 0,24 | 0,0432 | 0,0008 | 0,24 | 0,0432 | 0,0012 | 0,34 | 0,0605 | 0,0017 | 0,34 | 0,0605 | 0,0027 | 0,49 | 0,0692 | 0,0022 | 0,49 | 0,0692 | 0,0034 |
| A07- | Linz Prinz Eugenstraße | Linz Hafenstraße | 0,45 | 0,0809 | 0,0014 | 0,45 | 0,0809 | 0,0022 | 0,63 | 0,1133 | 0,0033 | 0,63 | 0,1133 | 0,0051 | 0,91 | 0,1295 | 0,0041 | 0,91 | 0,1295 | 0,0065 |
| A07- | Linz Hafenstraße | Linz Urfa hr | 0,18 | 0,0318 | 0,0006 | 0,18 | 0,0318 | 0,0009 | 0,25 | 0,0445 | 0,0013 | 0,25 | 0,0445 | 0,0020 | 0,36 | 0,0509 | 0,0016 | 0,36 | 0,0509 | 0,0025 |
| A07- | Linz Urfa hr | Linz Dornach | 0,43 | 0,0770 | 0,0013 | 0,43 | 0,0770 | 0,0021 | 0,60 | 0,1078 | 0,0031 | 0,60 | 0,1078 | 0,0049 | 0,86 | 0,1232 | 0,0039 | 0,87 | 0,1232 | 0,0061 |
| A07- | Linz Dornach | Treffling | 0,94 | 0,1694 | 0,0030 | 0,95 | 0,1694 | 0,0047 | 1,32 | 0,2371 | 0,0068 | 1,33 | 0,2371 | 0,0107 | 1,90 | 0,2710 | 0,0086 | 1,90 | 0,2710 | 0,0135 |
| A07- | Treffling | Gallneukirchen | 0,71 | 0,1276 | 0,0022 | 0,71 | 0,1276 | 0,0035 | 1,00 | 0,1786 | 0,0051 | 1,00 | 0,1786 | 0,0081 | 1,43 | 0,2042 | 0,0065 | 1,44 | 0,2042 | 0,0102 |
| A07- | Gallneukirchen | Engerwitzdorf | 0,63 | 0,1137 | 0,0020 | 0,63 | 0,1137 | 0,0031 | 0,89 | 0,1592 | 0,0046 | 0,89 | 0,1592 | 0,0072 | 1,28 | 0,1819 | 0,0058 | 1,28 | 0,1819 | 0,0091 |
| A07- | Engerwitzdorf | Unterweikersdorf | 0,81 | 0,1458 | 0,0026 | 0,81 | 0,1458 | 0,0040 | 1,14 | 0,2041 | 0,0059 | 1,14 | 0,2041 | 0,0092 | 1,63 | 0,2332 | 0,0074 | 1,64 | 0,2332 | 0,0116 |
| A08- | KN Voralpenkreuz | Wels West | 2,49 | 0,4471 | 0,0078 | 2,50 | 0,4471 | 0,0123 | 3,50 | 0,6260 | 0,0180 | 3,51 | 0,6260 | 0,0283 | 5,02 | 0,7154 | 0,0227 | 5,03 | 0,7154 | 0,0357 |
| A08- | Wels West | KN Wels | 0,88 | 0,1577 | 0,0028 | 0,88 | 0,1577 | 0,0043 | 1,23 | 0,2208 | 0,0063 | 1,24 | 0,2208 | 0,0100 | 1,77 | 0,2523 | 0,0080 | 1,77 | 0,2523 | 0,0126 |
| A08- | KN Wels | Pichl/Bad Schallerbach | 0,97 | 0,1735 | 0,0030 | 0,97 | 0,1735 | 0,0048 | 1,36 | 0,2429 | 0,0070 | 1,36 | 0,2429 | 0,0110 | 1,95 | 0,2776 | 0,0088 | 1,95 | 0,2776 | 0,0138 |
| A08- | Pichl/Bad Schallerbach | Meggenhofen Gallspace | 2,44 | 0,4384 | 0,0077 | 2,45 | 0,4384 | 0,0121 | 3,43 | 0,6138 | 0,0176 | 3,44 | 0,6138 | 0,0277 | 4,92 | 0,7015 | 0,0223 | 4,93 | 0,7015 | 0,0350 |
| A08- | Meggenhofen Gallspace | Haag am Hausruck | 2,66 | 0,4778 | 0,0084 | 2,67 | 0,4778 | 0,0131 | 3,74 | 0,6690 | 0,0192 | 3,75 | 0,6690 | 0,0302 | 5,36 | 0,7645 | 0,0243 | 5,37 | 0,7645 | 0,0381 |
| A08- | Haag am Hausruck | Ried im Innkreis | 2,43 | 0,4361 | 0,0076 | 2,43 | 0,4361 | 0,0120 | 3,41 | 0,6105 | 0,0176 | 3,42 | 0,6105 | 0,0276 | 4,89 | 0,6977 | 0,0221 | 4,90 | 0,6977 | 0,0348 |
| A08- | Ried im Innkreis | Ort im Innkreis | 2,61 | 0,4680 | 0,0082 | 2,61 | 0,4680 | 0,0129 | 3,66 | 0,6553 | 0,0188 | 3,67 | 0,6553 | 0,0296 | 5,25 | 0,7489 | 0,0238 | 5,26 | 0,7489 | 0,0373 |
| A08- | Ort im Innkreis | Schärding Suben | 1,97 | 0,3533 | 0,0062 | 1,97 | 0,3533 | 0,0097 | 2,76 | 0,4946 | 0,0142 | 2,77 | 0,4946 | 0,0223 | 3,96 | 0,5652 | 0,0179 | 3,97 | 0,5652 | 0,0282 |
| A08- | Schärding Suben | Staatsgrenze Suben | 0,50 | 0,0893 | 0,0016 | 0,50 | 0,0893 | 0,0025 | 0,70 | 0,1250 | 0,0036 | 0,70 | 0,1250 | 0,0056 | 1,00 | 0,1428 | 0,0045 | 1,00 | 0,1428 | 0,0071 |
| A09- | KN Voralpenkreuz | Ried im Traunkreis | 1,23 | 0,2200 | 0,0039 | 1,23 | 0,2200 | 0,0061 | 1,72 | 0,3081 | 0,0089 | 1,73 | 0,3081 | 0,0139 | 2,47 | 0,3521 | 0,0112 | 2,47 | 0,3521 | 0,0175 |
| A09- | Ried im Traunkreis | Inzersdorf Kirchdorf | 2,30 | 0,4128 | 0,0072 | 2,30 | 0,4128 | 0,0114 | 3,23 | 0,5779 | 0,0166 | 3,24 | 0,5779 | 0,0261 | 4,63 | 0,6604 | 0,0209 | 4,64 | 0,6604 | 0,0329 |
| A09- | Inzersdorf Kirchdorf | Klaus | 2,80 | 0,5028 | 0,0088 | 2,81 | 0,5028 | 0,0138 | 3,93 | 0,7039 | 0,0202 | 3,94 | 0,7039 | 0,0318 | 5,64 | 0,8045 | 0,0255 | 5,65 | 0,8045 | 0,0401 |
| A09- | Klaus | St. Pankratz | 1,78 | 0,3196 | 0,0056 | 1,78 | 0,3196 | 0,0088 | 2,50 | 0,4474 | 0,0129 | 2,51 | 0,4474 | 0,0202 | 3,58 | 0,5114 | 0,0162 | 3,59 | 0,5114 | 0,0255 |
| A09- | St. Pankratz | Roßleiten Windischgarsten | 2,48 | 0,4459 | 0,0078 | 2,49 | 0,4459 | 0,0123 | 3,49 | 0,6243 | 0,0179 | 3,50 | 0,6243 | 0,0282 | 5,00 | 0,7135 | 0,0226 | 5,01 | 0,7135 | 0,0356 |
| A09- | Roßleiten Windischgarsten | Gleinkerau | 1,17 | 0,2096 | 0,0037 | 1,17 | 0,2096 | 0,0058 | 1,64 | 0,2934 | 0,0084 | 1,64 | 0,2934 | 0,0133 | 2,35 | 0,3354 | 0,0106 | 2,36 | 0,3354 | 0,0167 |
| A09- | Gleinkerau | Spital am Pyhrn | 0,88 | 0,1580 | 0,0028 | 0,88 | 0,1580 | 0,0043 | 1,24 | 0,2212 | 0,0064 | 1,24 | 0,2212 | 0,0100 | 1,77 | 0,2528 | 0,0080 | 1,78 | 0,2528 | 0,0126 |
| A09- | Spital am Pyhrn | Ardning / Admont | 4,53 | 0,4022 | 0,0070 | 4,54 | 0,4022 | 0,0111 | 6,35 | 0,5631 | 0,0162 | 6,36 | 0,5631 | 0,0254 | 9,33 | 0,6436 | 0,0204 | 9,34 | 0,6436 | 0,0321 |
| A09- | Ardning / Admont | Liezen | 0,51 | 0,0917 | 0,0016 | 0,51 | 0,0917 | 0,0025 | 0,72 | 0,1284 | 0,0037 | 0,72 | 0,1284 | 0,0058 | 1,03 | 0,1467 | 0,0047 | 1,03 | 0,1467 | 0,0073 |
| A09- | Liezen | Rottenmann | 1,07 | 0,1916 | 0,0034 | 1,07 | 0,1916 | 0,0053 | 1,50 | 0,2682 | 0,0077 | 1,50 | 0,2682 | 0,0121 | 2,15 | 0,3065 | 0,0097 | 2,15 | 0,3065 | 0,0153 |
| A09- | Rottenmann | Trieben | 2,66 | 0,4776 | 0,0084 | 2,67 | 0,4776 | 0,0131 | 3,73 | 0,6686 | 0,0192 | 3,74 | 0,6686 | 0,0302 | 5,36 | 0,7641 | 0,0242 | 5,37 | 0,7641 | 0,0381 |
| A09- | Trieben | Treglwang | 2,16 | 0,3883 | 0,0068 | 2,17 | 0,3883 | 0,0107 | 3,04 | 0,5436 | 0,0156 | 3,04 | 0,5436 | 0,0246 | 4,36 | 0,6212 | 0,0197 | 4,37 | 0,6212 | 0,0310 |
| A09- | Treglwang | Kalwang | 2,91 | 0,5218 | 0,0091 | 2,91 | 0,5218 | 0,0143 | 4,08 | 0,7305 | 0,0210 | 4,09 | 0,7305 | 0,0330 | 5,85 | 0,8349 | 0,0265 | 5,87 | 0,8349 | 0,0416 |
| A09- | Kalwang | Mautern | 1,35 | 0,2430 | 0,0043 | 1,36 | 0,2430 | 0,0067 | 1,90 | 0,3401 | 0,0098 | 1,90 | 0,3401 | 0,0154 | 2,73 | 0,3887 | 0,0123 | 2,73 | 0,3887 | 0,0194 |
| A09- | Mautern | Kammern | 1,52 | 0,2733 | 0,0048 | 1,53 | 0,2733 | 0,0075 | 2,14 | 0,3826 | 0,0110 | 2,14 | 0,3826 | 0,0173 | 3,07 | 0,4373 | 0,0139 | 3,07 | 0,4373 | 0,0218 |
| A09- | Kammern | Traboch | 1,59 | 0,2858 | 0,0050 | 1,60 | 0,2858 | 0,0079 | 2,23 | 0,4001 | 0,0115 | 2,24 | 0,4001 | 0,0181 | 3,21 | 0,4572 | 0,0145 | 3,21 | 0,4572 | 0,0228 |
| A09- | Traboch | Terminal St. Michael | 0,31 | 0,0561 | 0,0010 | 0,31 | 0,0561 | 0,0015 | 0,44 | 0,0786 | 0,0023 | 0,44 | 0,0786 | 0,0035 | 0,63 | 0,0898 | 0,0028 | 0,63 | 0,0898 | 0,0045 |
| A09- | Terminal St. Michael | KN St. Michael | 0,59 | 0,1052 | 0,0018 | 0,59 | 0,1052 | 0,0029 | 0,82 | 0,1473 | 0,0042 | 0,82 | 0,1473 | 0,0067 | 1,18 | 0,1683 | 0,0053 | 1,18 | 0,1683 | 0,0084 |
| A09- | KN St. Michael | Übelbach | 11,04 | 0,9797 | 0,0171 | 11,05 | 0,9797 | 0,0289 | 15,48 | 1,3716 | 0,0394 | 15,50 | 1,3716 | 0,0620 | 22,72 | 1,5676 | 0,0497 | 22,74 | 1,5676 | 0,0781 |
| A09- | Übelbach | KN Peggau Deutschfeistritz | 1,81 | 0,3240 | 0,0057 | 1,81 | 0,3240 | 0,0089 | 2,53 | 0,4537 | 0,0130 | 2,54 | 0,4537 | 0,0205 | 3,63 | 0,5185 | 0,0164 | 3,64 | 0,5185 | 0,0258 |
| A09- | KN Peggau Deutschfeistritz | Gratkorn Nord | 0,86 | 0,1535 | 0,0027 | 0,86 | 0,1535 | 0,0042 | 1,20 | 0,2149 | 0,0062 | 1,20 | 0,2149 | 0,0097 | 1,72 | 0,2456 | 0,0078 | 1,73 | 0,2456 | 0,0122 |
| A09- | Gratkorn Nord | Gratkorn Süd | 0,94 | 0,1686 | 0,0030 | 0,94 | 0,1686 | 0,0046 | 1,32 | 0,2360 | 0,0068 | 1,32 | 0,2360 | 0,0107 | 1,89 | 0,2698 | 0,0086 | 1,90 | 0,2698 | |

| | | | | | | | | | | | | | | | | | | | | |
|------|--|---|-------|--------|--------|-------|--------|--------|-------|--------|--------|-------|--------|--------|-------|--------|--------|-------|--------|--------|
| A10- | Hallein | Kuchl | 1,30 | 0,2342 | 0,0041 | 1,31 | 0,2342 | 0,0064 | 1,83 | 0,3278 | 0,0094 | 1,84 | 0,3278 | 0,0148 | 2,63 | 0,3747 | 0,0119 | 2,63 | 0,3747 | 0,0187 |
| A10- | Kuchl | Golling / Abtenau | 1,31 | 0,2354 | 0,0041 | 1,31 | 0,2354 | 0,0065 | 1,84 | 0,3296 | 0,0095 | 1,85 | 0,3296 | 0,0149 | 2,64 | 0,3766 | 0,0119 | 2,65 | 0,3766 | 0,0188 |
| A10- | Golling / Abtenau | Paß Lueg | 1,37 | 0,2456 | 0,0043 | 1,37 | 0,2456 | 0,0068 | 1,92 | 0,3439 | 0,0099 | 1,93 | 0,3439 | 0,0155 | 2,76 | 0,3930 | 0,0125 | 2,76 | 0,3930 | 0,0196 |
| A10- | Paß Lueg | Werfen | 1,95 | 0,3499 | 0,0061 | 1,95 | 0,3499 | 0,0096 | 2,94 | 0,4898 | 0,0141 | 2,74 | 0,4898 | 0,0221 | 3,92 | 0,5598 | 0,0178 | 3,93 | 0,5598 | 0,0279 |
| A10- | Werfen | Pfarrwerfen / Werfen | 0,25 | 0,0456 | 0,0008 | 0,25 | 0,0456 | 0,0013 | 0,36 | 0,0638 | 0,0018 | 0,36 | 0,0638 | 0,0029 | 0,51 | 0,0730 | 0,0023 | 0,51 | 0,0730 | 0,0036 |
| A10- | Pfarrwerfen / Werfen | KN Pongau | 0,55 | 0,0990 | 0,0017 | 0,55 | 0,0990 | 0,0027 | 0,77 | 0,1385 | 0,0040 | 0,78 | 0,1385 | 0,0063 | 1,11 | 0,1583 | 0,0050 | 1,11 | 0,1583 | 0,0079 |
| A101 | KN Pongau | Bischofshofen Mühlbach a. Hochkönig | 0,82 | 0,1472 | 0,0026 | 0,82 | 0,1472 | 0,0040 | 1,15 | 0,2061 | 0,0059 | 1,15 | 0,2061 | 0,0093 | 1,65 | 0,2355 | 0,0075 | 1,66 | 0,2355 | 0,0117 |
| A10- | KN Pongau | Lammertal Hütttau | 2,24 | 0,4025 | 0,0070 | 2,25 | 0,4025 | 0,0111 | 3,15 | 0,5635 | 0,0162 | 3,16 | 0,5635 | 0,0255 | 4,51 | 0,6440 | 0,0204 | 4,53 | 0,6440 | 0,0321 |
| A10- | Lammertal Hütttau | F. Verbindung GH Eben | 0,58 | 0,1036 | 0,0018 | 0,58 | 0,1036 | 0,0028 | 0,81 | 0,1450 | 0,0042 | 0,81 | 0,1450 | 0,0066 | 1,16 | 0,1658 | 0,0053 | 1,17 | 0,1658 | 0,0083 |
| A10- | F. Verbindung GH Eben | Eben | 0,27 | 0,0480 | 0,0008 | 0,27 | 0,0480 | 0,0013 | 0,38 | 0,0672 | 0,0019 | 0,38 | 0,0672 | 0,0030 | 0,54 | 0,0768 | 0,0024 | 0,54 | 0,0768 | 0,0038 |
| A10- | Eben | Radstadt Altenmarkt Graz | 0,59 | 0,1066 | 0,0019 | 0,60 | 0,1066 | 0,0029 | 0,83 | 0,1492 | 0,0043 | 0,84 | 0,1492 | 0,0067 | 1,20 | 0,1706 | 0,0054 | 1,20 | 0,1706 | 0,0085 |
| A10- | Radstadt Altenmarkt Graz | Flachau | 0,83 | 0,1491 | 0,0026 | 0,83 | 0,1491 | 0,0041 | 1,17 | 0,2087 | 0,0060 | 1,17 | 0,2087 | 0,0094 | 1,67 | 0,2385 | 0,0076 | 1,68 | 0,2385 | 0,0119 |
| A10- | Flachau | Flachauwinkel | 3,05 | 0,2908 | 0,0051 | 3,05 | 0,2908 | 0,0080 | 4,27 | 0,4071 | 0,0117 | 4,28 | 0,4071 | 0,0184 | 6,26 | 0,4653 | 0,0148 | 6,27 | 0,4653 | 0,0232 |
| A10- | Flachauwinkel | Zederhaus | 7,69 | 0,7328 | 0,0128 | 7,69 | 0,7328 | 0,0202 | 10,77 | 1,0260 | 0,0295 | 10,79 | 1,0260 | 0,0464 | 15,78 | 1,1725 | 0,0372 | 15,80 | 1,1725 | 0,0584 |
| A10- | Zederhaus | St. Michael/Lungau | 5,07 | 0,4835 | 0,0085 | 5,08 | 0,4835 | 0,0133 | 7,11 | 0,6769 | 0,0195 | 7,12 | 0,6769 | 0,0306 | 10,41 | 0,7736 | 0,0245 | 10,43 | 0,7736 | 0,0386 |
| A10- | St. Michael/Lungau | Rennweg Katschberg | 3,72 | 0,3545 | 0,0062 | 3,72 | 0,3545 | 0,0097 | 5,21 | 0,4963 | 0,0143 | 5,22 | 0,4963 | 0,0224 | 7,63 | 0,5672 | 0,0180 | 7,65 | 0,5672 | 0,0283 |
| A102 | Seeboden | KN Spittal Millstätter See | 0,43 | 0,0776 | 0,0014 | 0,43 | 0,0776 | 0,0021 | 0,61 | 0,1086 | 0,0031 | 0,61 | 0,1086 | 0,0049 | 0,87 | 0,1242 | 0,0039 | 0,87 | 0,1242 | 0,0062 |
| A102 | KN Spittal Millstätter See | Lendorf | 0,93 | 0,1674 | 0,0029 | 0,93 | 0,1674 | 0,0046 | 1,31 | 0,2344 | 0,0067 | 1,31 | 0,2344 | 0,0106 | 1,88 | 0,2678 | 0,0085 | 1,88 | 0,2678 | 0,0134 |
| A10- | Rennweg Katschberg | Gmünd Maltatal | 3,77 | 0,6774 | 0,0119 | 3,78 | 0,6774 | 0,0186 | 5,30 | 0,9483 | 0,0273 | 5,31 | 0,9483 | 0,0428 | 7,60 | 1,0838 | 0,0344 | 7,62 | 1,0838 | 0,0540 |
| A10- | Gmünd Maltatal | KN Spittal Millstätter See | 2,15 | 0,3855 | 0,0067 | 2,15 | 0,3855 | 0,0106 | 3,01 | 0,5397 | 0,0155 | 3,02 | 0,5397 | 0,0244 | 4,32 | 0,6168 | 0,0196 | 4,34 | 0,6168 | 0,0307 |
| A10- | KN Spittal Millstätter See | Spittal Ost | 1,63 | 0,2920 | 0,0051 | 1,63 | 0,2920 | 0,0080 | 2,28 | 0,4088 | 0,0118 | 2,29 | 0,4088 | 0,0185 | 3,28 | 0,4672 | 0,0148 | 3,28 | 0,4672 | 0,0233 |
| A10- | Spittal Ost | Paternion Feistritz | 2,81 | 0,5043 | 0,0088 | 2,82 | 0,5043 | 0,0139 | 3,94 | 0,7060 | 0,0203 | 3,95 | 0,7060 | 0,0319 | 5,66 | 0,8068 | 0,0256 | 5,67 | 0,8068 | 0,0402 |
| A10- | Paternion Feistritz | Villach West | 3,03 | 0,5435 | 0,0095 | 3,03 | 0,5435 | 0,0149 | 4,25 | 0,7609 | 0,0219 | 4,26 | 0,7609 | 0,0344 | 6,10 | 0,8696 | 0,0276 | 6,11 | 0,8696 | 0,0433 |
| A10- | Villach West | Villach Ossiacher See | 1,31 | 0,2350 | 0,0041 | 1,31 | 0,2350 | 0,0065 | 1,84 | 0,3289 | 0,0095 | 1,84 | 0,3289 | 0,0149 | 2,64 | 0,3759 | 0,0119 | 2,64 | 0,3759 | 0,0187 |
| A10- | Villach Ossiacher See | KN Villach | 1,02 | 0,1836 | 0,0032 | 1,02 | 0,1836 | 0,0050 | 1,44 | 0,2570 | 0,0074 | 1,44 | 0,2570 | 0,0116 | 2,06 | 0,2938 | 0,0093 | 2,06 | 0,2938 | 0,0146 |
| A11- | KN Villach | St. Niklas Faakersee | 0,73 | 0,1314 | 0,0023 | 0,73 | 0,1314 | 0,0036 | 1,03 | 0,1840 | 0,0053 | 1,03 | 0,1840 | 0,0083 | 1,47 | 0,2102 | 0,0067 | 1,48 | 0,2102 | 0,0105 |
| A11- | St. Niklas Faakersee | St. Jakob/Rosental | 1,84 | 0,3300 | 0,0058 | 1,84 | 0,3300 | 0,0091 | 2,58 | 0,4621 | 0,0133 | 2,59 | 0,4621 | 0,0209 | 3,70 | 0,5281 | 0,0167 | 3,71 | 0,5281 | 0,0263 |
| A11- | St. Jakob/Rosental | Staatsgrenze Karawankentunnel | 16,10 | 0,3883 | 0,0068 | 16,11 | 0,3883 | 0,0107 | 22,55 | 0,5436 | 0,0156 | 22,56 | 0,5436 | 0,0246 | 33,63 | 0,6212 | 0,0197 | 33,64 | 0,6212 | 0,0310 |
| A12- | Staatsgrenze Kufstein | Kufstein Nord | 0,36 | 0,0000 | 0,0000 | 0,36 | 0,0000 | 0,0000 | 0,51 | 0,0000 | 0,0000 | 0,51 | 0,0000 | 0,0000 | 0,76 | 0,0000 | 0,0000 | 0,76 | 0,0000 | 0,0000 |
| A12- | Kufstein Nord | Kufstein Süd | 0,93 | 0,0000 | 0,0000 | 0,93 | 0,0000 | 0,0000 | 1,31 | 0,0000 | 0,0000 | 1,31 | 0,0000 | 0,0000 | 1,96 | 0,0000 | 0,0000 | 1,96 | 0,0000 | 0,0000 |
| A12- | Kufstein Süd | Kirchbichl Langkampfen | 1,27 | 0,0000 | 0,0000 | 1,27 | 0,0000 | 0,0000 | 1,78 | 0,0000 | 0,0000 | 1,78 | 0,0000 | 0,0000 | 2,68 | 0,0000 | 0,0000 | 2,68 | 0,0000 | 0,0000 |
| A12- | Kirchbichl Langkampfen | Wörgl Ost St.Johann i. T. Brixental | 1,25 | 0,0000 | 0,0000 | 1,25 | 0,0000 | 0,0000 | 1,75 | 0,0000 | 0,0000 | 1,75 | 0,0000 | 0,0000 | 2,62 | 0,0000 | 0,0000 | 2,62 | 0,0000 | 0,0000 |
| A12- | Wörgl Ost St.Johann i. T. Brixental | Wörgl West | 0,66 | 0,0000 | 0,0000 | 0,66 | 0,0000 | 0,0000 | 0,92 | 0,0000 | 0,0000 | 0,92 | 0,0000 | 0,0000 | 1,38 | 0,0000 | 0,0000 | 1,38 | 0,0000 | 0,0000 |
| A12- | Wörgl West | Kramsach Rattenberg Brixlegg | 2,80 | 0,0000 | 0,0000 | 2,80 | 0,0000 | 0,0000 | 3,92 | 0,0000 | 0,0000 | 3,92 | 0,0000 | 0,0000 | 5,88 | 0,0000 | 0,0000 | 5,88 | 0,0000 | 0,0000 |
| A12- | Kramsach Rattenberg Brixlegg | Wiesing Achensee Zillertal | 1,72 | 0,0000 | 0,0000 | 1,72 | 0,0000 | 0,0000 | 2,40 | 0,0000 | 0,0000 | 2,40 | 0,0000 | 0,0000 | 3,61 | 0,0000 | 0,0000 | 3,61 | 0,0000 | 0,0000 |
| A12- | Wiesing Achensee Zillertal | Jenbach | 0,68 | 0,0000 | 0,0000 | 0,68 | 0,0000 | 0,0000 | 0,95 | 0,0000 | 0,0000 | 0,95 | 0,0000 | 0,0000 | 1,43 | 0,0000 | 0,0000 | 1,43 | 0,0000 | 0,0000 |
| A12- | Jenbach | Schwaz | 1,50 | 0,0000 | 0,0000 | 1,50 | 0,0000 | 0,0000 | 2,10 | 0,0000 | 0,0000 | 2,10 | 0,0000 | 0,0000 | 3,15 | 0,0000 | 0,0000 | 3,15 | 0,0000 | 0,0000 |
| A12- | Schwaz | Vomp | 0,86 | 0,0000 | 0,0000 | 0,86 | 0,0000 | 0,0000 | 1,20 | 0,0000 | 0,0000 | 1,20 | 0,0000 | 0,0000 | 1,80 | 0,0000 | 0,0000 | 1,80 | 0,0000 | 0,0000 |
| A12- | Vomp | Wattens | 1,77 | 0,0000 | 0,0000 | 1,77 | 0,0000 | 0,0000 | 2,47 | 0,0000 | 0,0000 | 2,47 | 0,0000 | 0,0000 | 3,71 | 0,0000 | 0,0000 | 3,71 | 0,0000 | 0,0000 |
| A12- | Wattens | Hall/Tirol Mitte | 1,57 | 0,0000 | 0,0000 | 1,57 | 0,0000 | 0,0000 | 2,19 | 0,0000 | 0,0000 | 2,19 | 0,0000 | 0,0000 | 3,29 | 0,0000 | 0,0000 | 3,29 | 0,0000 | 0,0000 |
| A12- | Hall/Tirol Mitte | Hall/Tirol West | 0,63 | 0,0000 | 0,0000 | 0,63 | 0,0000 | 0,0000 | 0,88 | 0,0000 | 0,0000 | 0,88 | 0,0000 | 0,0000 | 1,32 | 0,0000 | 0,0000 | 1,32 | 0,0000 | 0,0000 |
| A12- | Hall/Tirol West | A12 Innsbruck Ost | 0,70 | 0,0000 | 0,0000 | 0,70 | 0,0000 | 0,0000 | 0,97 | 0,0000 | 0,0000 | 0,97 | 0,0000 | 0,0000 | 1,46 | 0,0000 | 0,0000 | 1,46 | 0,0000 | 0,0000 |
| A12- | A12 Innsbruck Ost | Innsbruck Mitte | 0,48 | 0,0226 | 0,0004 | 0,48 | 0,0226 | 0,0006 | 0,67 | 0,0317 | 0,0009 | 0,67 | 0,0317 | 0,0014 | 0,99 | 0,0362 | 0,0011 | 0,99 | 0,0362 | 0,0018 |
| A12- | Innsbruck Mitte | A12 Innsbruck West | 0,71 | 0,1280 | 0,0022 | 0,71 | 0,1280 | 0,0035 | 1,00 | 0,1792 | 0,0052 | 1,00 | 0,1792 | 0,0081 | 1,44 | 0,2048 | 0,0065 | 1,44 | 0,2048 | 0,0102 |
| A12- | A12 Innsbruck West | Innsbruck Kranebitten | 0,93 | 0,1678 | 0,0029 | 0,94 | 0,1678 | 0,0046 | 1,31 | 0,2349 | 0,0068 | 1,32 | 0,2349 | 0,0106 | 1,88 | 0,2684 | 0,0085 | 1,89 | 0,2684 | 0,0134 |
| A12- | Innsbruck Kranebitten | Zirl Ost Garmisch Seefeld | 1,08 | 0,1947 | 0,0034 | 1,09 | 0,1947 | 0,0054 | 1,52 | 0,2726 | 0,0078 | 1,53 | 0,2726 | 0,0123 | 2,18 | 0,3115 | 0,0099 | 2,19 | 0,3115 | 0,0155 |
| A12- | Zirl Ost Garmisch Seefeld | Zirl West | 0,68 | 0,1218 | 0,0021 | 0,68 | 0,1218 | 0,0033 | 0,95 | 0,1705 | 0,0049 | 0,95 | 0,1705 | 0,0077 | 1,37 | 0,1949 | 0,0062 | 1,37 | 0,1949 | 0,0097 |
| A12- | Zirl West | Petttau | 1,22 | 0,2181 | 0,0038 | 1,22 | 0,2181 | 0,0060 | 1,71 | 0,3054 | 0,0088 | 1,71 | 0,3054 | 0,0138 | 2,45 | 0,3490 | 0,0111 | 2,45 | 0,3490 | 0,0174 |
| A12- | Petttau | Telfs Ost | 1,23 | 0,2205 | 0,0039 | 1,23 | 0,2205 | 0,0061 | 1,72 | 0,3087 | 0,0089 | 1,73 | 0,3087 | 0,0139 | 2,47 | 0,3528 | 0,0112 | 2,48 | 0,3528 | 0,0176 |
| A12- | Telfs Ost | Telfs West | 0,60 | 0,1077 | 0,0019 | 0,60 | 0,1077 | 0,0030 | 0,84 | 0,1508 | 0,0043 | 0,84 | 0,1508 | 0,0068 | 1,21 | 0,1723 | 0,0055 | 1,21 | 0,1723 | 0,0086 |
| A12- | Telfs West | Mötz Reutte | 1,94 | 0,3480 | 0,0061 | 1,94 | 0,3480 | 0,0096 | 2,72 | 0,4872 | 0,0140 | 2,73 | 0,4872 | 0,0220 | 3,90 | 0,5568 | 0,0177 | 3,91 | 0,5568 | 0,0278 |
| A12- | Mötz Reutte | Haiming Ötztal | 2,26 | 0,4048 | 0,0071 | 2,26 | 0,4048 | 0,0111 | 3,16 | 0,5667 | 0,0163 | 3,17 | 0,5667 | 0,0256 | 4,54 | 0,6477 | 0,0205 | 4,55 | 0,6477 | 0,0323 |
| A12- | Haiming Ötztal | Imst | 1,80 | 0,3222 | 0,0056 | 1,80 | 0,3222 | 0,0089 | 2,52 | 0,4511 | 0,0130 | 2,53 | 0,4511 | 0,0204 | 3,61 | 0,5156 | 0,0164 | 3,62 | 0,5156 | 0,0257 |
| A12- | Imst | Imst Au | 0,30 | 0,0546 | 0,0010 | 0,30 | 0,0546 | 0,0015 | 0,43 | 0,0764 | 0,0022 | 0,43 | 0,0764 | 0,0035 | 0,61 | 0,0873 | 0,0028 | 0,61 | 0,0873 | 0,0044 |
| A12- | Imst Au | Mils | 0,65 | 0,1172 | 0,0021 | 0,65 | 0,1172 | 0,0032 | 0,92 | 0,1641 | 0,0047 | 0,92 | 0,1641 | 0,0074 | 1,31 | 0,1875 | 0,0059 | 1,32 | 0,1875 | 0,0093 |
| A12- | Mils | Mils Schönwies | 1,05 | 0,1888 | 0,0033 | 1,05 | 0,1888 | 0,0052 | 1,48 | 0,2643 | 0,0076 | 1,48 | 0,2643 | 0,0119 | 2,12 | 0,3021 | 0,0096 | 2,12 | | |

| | | | | | | | | | | | | | | | | | | | | |
|------|------------------------------------|------------------------------------|------|--------|--------|------|--------|--------|------|--------|--------|------|--------|--------|------|--------|--------|------|--------|--------|
| A14- | Staatsgrenze Hörbranz | Hörbranz Lochau | 0,28 | 0,0504 | 0,0009 | 0,28 | 0,0504 | 0,0014 | 0,39 | 0,0706 | 0,0020 | 0,40 | 0,0706 | 0,0032 | 0,57 | 0,0807 | 0,0026 | 0,57 | 0,0807 | 0,0040 |
| A14- | Hörbranz Lochau | KN Bregenz | 1,73 | 0,3100 | 0,0054 | 1,73 | 0,3100 | 0,0085 | 2,42 | 0,4339 | 0,0125 | 2,43 | 0,4339 | 0,0196 | 3,48 | 0,4959 | 0,0157 | 3,49 | 0,4959 | 0,0247 |
| A14- | KN Bregenz | Lauterach Wolfurt | 0,09 | 0,0156 | 0,0003 | 0,09 | 0,0156 | 0,0004 | 0,12 | 0,0218 | 0,0006 | 0,12 | 0,0218 | 0,0010 | 0,17 | 0,0249 | 0,0008 | 0,17 | 0,0249 | 0,0012 |
| A14- | Lauterach Wolfurt | Wolfurt Lauterach | 0,77 | 0,1379 | 0,0024 | 0,77 | 0,1379 | 0,0038 | 1,08 | 0,1931 | 0,0056 | 1,08 | 0,1931 | 0,0087 | 1,55 | 0,2207 | 0,0070 | 1,55 | 0,2207 | 0,0110 |
| A14- | Wolfurt Lauterach | Dornbirn Nord Bregenzerwald | 0,30 | 0,0534 | 0,0009 | 0,30 | 0,0534 | 0,0015 | 0,42 | 0,0747 | 0,0021 | 0,42 | 0,0747 | 0,0034 | 0,60 | 0,0854 | 0,0027 | 0,60 | 0,0854 | 0,0043 |
| A14- | Dornbirn Nord Bregenzerwald | Dornbirn Süd Lustenau | 0,83 | 0,1491 | 0,0026 | 0,83 | 0,1491 | 0,0041 | 1,17 | 0,2087 | 0,0060 | 1,17 | 0,2087 | 0,0094 | 1,67 | 0,2385 | 0,0076 | 1,68 | 0,2385 | 0,0119 |
| A14- | Dornbirn Süd Lustenau | Hohenems | 1,17 | 0,2098 | 0,0037 | 1,17 | 0,2098 | 0,0058 | 1,64 | 0,2937 | 0,0084 | 1,64 | 0,2937 | 0,0133 | 2,35 | 0,3356 | 0,0106 | 2,36 | 0,3356 | 0,0167 |
| A14- | Hohenems | Altach Götzis | 0,76 | 0,1368 | 0,0024 | 0,76 | 0,1368 | 0,0038 | 1,07 | 0,1915 | 0,0055 | 1,07 | 0,1915 | 0,0087 | 1,53 | 0,2188 | 0,0069 | 1,54 | 0,2188 | 0,0109 |
| A14- | Altach Götzis | Götzis | 0,58 | 0,1043 | 0,0018 | 0,58 | 0,1043 | 0,0029 | 0,82 | 0,1460 | 0,0042 | 0,82 | 0,1460 | 0,0066 | 1,17 | 0,1668 | 0,0053 | 1,17 | 0,1668 | 0,0083 |
| A14- | Götzis | Klaus Koblach | 0,50 | 0,0906 | 0,0016 | 0,51 | 0,0906 | 0,0025 | 0,71 | 0,1268 | 0,0036 | 0,71 | 0,1268 | 0,0057 | 1,02 | 0,1449 | 0,0046 | 1,02 | 0,1449 | 0,0072 |
| A14- | Klaus Koblach | Rankweil | 0,89 | 0,1592 | 0,0028 | 0,89 | 0,1592 | 0,0044 | 1,24 | 0,2228 | 0,0064 | 1,25 | 0,2228 | 0,0101 | 1,79 | 0,2547 | 0,0081 | 1,79 | 0,2547 | 0,0127 |
| A14- | Rankweil | Feldkirch Frastanz | 1,26 | 0,2267 | 0,0040 | 1,27 | 0,2267 | 0,0062 | 1,77 | 0,3174 | 0,0091 | 1,78 | 0,3174 | 0,0143 | 2,54 | 0,3628 | 0,0115 | 2,55 | 0,3628 | 0,0181 |
| A14- | Feldkirch Frastanz | Nenzing Bludesch | 2,00 | 0,3585 | 0,0063 | 2,00 | 0,3585 | 0,0099 | 2,80 | 0,5019 | 0,0144 | 2,81 | 0,5019 | 0,0227 | 4,02 | 0,5736 | 0,0182 | 4,03 | 0,5736 | 0,0286 |
| A14- | Nenzing Bludesch | Bludenz Nüziders | 1,48 | 0,2662 | 0,0047 | 1,49 | 0,2662 | 0,0073 | 2,08 | 0,3726 | 0,0107 | 2,09 | 0,3726 | 0,0168 | 2,99 | 0,4259 | 0,0135 | 2,99 | 0,4259 | 0,0212 |
| A14- | Bludenz Nüziders | Brandnertal | 0,21 | 0,0370 | 0,0006 | 0,21 | 0,0370 | 0,0010 | 0,29 | 0,0519 | 0,0015 | 0,29 | 0,0519 | 0,0023 | 0,42 | 0,0593 | 0,0019 | 0,42 | 0,0593 | 0,0030 |
| A14- | Brandnertal | Bludenz Bürs | 0,34 | 0,0618 | 0,0011 | 0,35 | 0,0618 | 0,0017 | 0,48 | 0,0865 | 0,0025 | 0,48 | 0,0865 | 0,0039 | 0,69 | 0,0989 | 0,0031 | 0,69 | 0,0989 | 0,0049 |
| A14- | Bludenz Bürs | Bludenz Montafon | 0,49 | 0,0876 | 0,0015 | 0,49 | 0,0876 | 0,0024 | 0,68 | 0,1226 | 0,0035 | 0,69 | 0,1226 | 0,0055 | 0,98 | 0,1402 | 0,0044 | 0,99 | 0,1402 | 0,0070 |
| A141 | KN Bregenz | Bregenz Citytunnel | 0,45 | 0,0802 | 0,0014 | 0,45 | 0,0802 | 0,0022 | 0,63 | 0,1123 | 0,0032 | 0,63 | 0,1123 | 0,0051 | 0,90 | 0,1284 | 0,0041 | 0,90 | 0,1284 | 0,0064 |
| A21- | KN Steinhäusl | Hochstraß | 0,74 | 0,1324 | 0,0023 | 0,74 | 0,1324 | 0,0036 | 1,03 | 0,1853 | 0,0053 | 1,04 | 0,1853 | 0,0084 | 1,48 | 0,2118 | 0,0067 | 1,49 | 0,2118 | 0,0106 |
| A21- | Hochstraß | Alland | 2,58 | 0,4624 | 0,0081 | 2,58 | 0,4624 | 0,0127 | 3,62 | 0,6474 | 0,0186 | 3,63 | 0,6474 | 0,0292 | 5,19 | 0,7399 | 0,0235 | 5,20 | 0,7399 | 0,0369 |
| A21- | Alland | Mayerling | 0,52 | 0,0939 | 0,0016 | 0,52 | 0,0939 | 0,0026 | 0,73 | 0,1314 | 0,0038 | 0,74 | 0,1314 | 0,0059 | 1,05 | 0,1502 | 0,0048 | 1,06 | 0,1502 | 0,0075 |
| A21- | Mayerling | Heiligenkreuz | 1,21 | 0,2175 | 0,0038 | 1,21 | 0,2175 | 0,0060 | 1,70 | 0,3045 | 0,0088 | 1,71 | 0,3045 | 0,0138 | 2,44 | 0,3480 | 0,0110 | 2,45 | 0,3480 | 0,0173 |
| A21- | Heiligenkreuz | Heiligenbrühl | 0,68 | 0,1212 | 0,0021 | 0,68 | 0,1212 | 0,0033 | 0,95 | 0,1697 | 0,0049 | 0,95 | 0,1697 | 0,0077 | 1,36 | 0,1940 | 0,0062 | 1,36 | 0,1940 | 0,0097 |
| A21- | Hinterbrühl | Gießhübl | 1,27 | 0,2274 | 0,0040 | 1,27 | 0,2274 | 0,0063 | 1,78 | 0,3184 | 0,0092 | 1,78 | 0,3184 | 0,0144 | 2,55 | 0,3638 | 0,0115 | 2,56 | 0,3638 | 0,0181 |
| A21- | Gießhübl | Brunn/Gebirge | 1,06 | 0,1903 | 0,0033 | 1,06 | 0,1903 | 0,0052 | 1,49 | 0,2664 | 0,0077 | 1,49 | 0,2664 | 0,0120 | 2,13 | 0,3044 | 0,0097 | 2,14 | 0,3044 | 0,0152 |
| A21- | Brunn/Gebirge | KN Vösendorf | 0,47 | 0,0846 | 0,0015 | 0,47 | 0,0846 | 0,0023 | 0,66 | 0,1185 | 0,0034 | 0,66 | 0,1185 | 0,0054 | 0,95 | 0,1354 | 0,0043 | 0,95 | 0,1354 | 0,0068 |
| A22- | KN Wien Kaisermühlen | Kaisermühlen | 0,37 | 0,0669 | 0,0012 | 0,37 | 0,0669 | 0,0018 | 0,52 | 0,0936 | 0,0027 | 0,52 | 0,0936 | 0,0042 | 0,75 | 0,1070 | 0,0034 | 0,75 | 0,1070 | 0,0053 |
| A22- | Kaisermühlen | Reichsbrücke | 0,31 | 0,0554 | 0,0010 | 0,31 | 0,0554 | 0,0015 | 0,43 | 0,0776 | 0,0022 | 0,43 | 0,0776 | 0,0035 | 0,62 | 0,0887 | 0,0028 | 0,62 | 0,0887 | 0,0044 |
| A22- | Reichsbrücke | Kagran Vienna International Center | 0,12 | 0,0214 | 0,0004 | 0,12 | 0,0214 | 0,0006 | 0,17 | 0,0299 | 0,0009 | 0,17 | 0,0299 | 0,0014 | 0,24 | 0,0342 | 0,0011 | 0,24 | 0,0342 | 0,0017 |
| A22- | Kagran Vienna International Center | Brigittenauebrücke | 0,19 | 0,0342 | 0,0006 | 0,19 | 0,0342 | 0,0009 | 0,27 | 0,0479 | 0,0014 | 0,27 | 0,0479 | 0,0022 | 0,38 | 0,0547 | 0,0017 | 0,38 | 0,0547 | 0,0027 |
| A22- | Brigittenauebrücke | Floridsdorferbrücke | 0,31 | 0,0552 | 0,0010 | 0,31 | 0,0552 | 0,0015 | 0,43 | 0,0773 | 0,0022 | 0,43 | 0,0773 | 0,0035 | 0,62 | 0,0883 | 0,0028 | 0,62 | 0,0883 | 0,0044 |
| A22- | Floridsdorferbrücke | KN Gürtel Nordbrücke | 0,20 | 0,0352 | 0,0006 | 0,20 | 0,0352 | 0,0010 | 0,28 | 0,0493 | 0,0014 | 0,28 | 0,0493 | 0,0022 | 0,39 | 0,0563 | 0,0018 | 0,40 | 0,0563 | 0,0028 |
| A22- | KN Gürtel Nordbrücke | Strebersdorf | 0,67 | 0,1203 | 0,0021 | 0,67 | 0,1203 | 0,0033 | 0,94 | 0,1684 | 0,0048 | 0,94 | 0,1684 | 0,0076 | 1,35 | 0,1925 | 0,0061 | 1,35 | 0,1925 | 0,0096 |
| A221 | Wien Nordbrücke | KN Gürtel Nordbrücke | 0,20 | 0,0355 | 0,0006 | 0,20 | 0,0355 | 0,0010 | 0,28 | 0,0497 | 0,0014 | 0,28 | 0,0497 | 0,0022 | 0,40 | 0,0568 | 0,0018 | 0,40 | 0,0568 | 0,0028 |
| A221 | KN Gürtel Nordbrücke | Wien Pragerstraße | 0,21 | 0,0382 | 0,0007 | 0,21 | 0,0382 | 0,0010 | 0,30 | 0,0535 | 0,0015 | 0,30 | 0,0535 | 0,0024 | 0,43 | 0,0611 | 0,0019 | 0,43 | 0,0611 | 0,0030 |
| A221 | Wien Pragerstraße | Wien Neujedlersdorf | 0,09 | 0,0167 | 0,0003 | 0,09 | 0,0167 | 0,0005 | 0,13 | 0,0234 | 0,0007 | 0,13 | 0,0234 | 0,0011 | 0,19 | 0,0268 | 0,0008 | 0,19 | 0,0268 | 0,0013 |
| A221 | Wien Neujedlersdorf | Brünnerstr/Shuttlewortstraße | 0,24 | 0,0424 | 0,0007 | 0,24 | 0,0424 | 0,0012 | 0,33 | 0,0594 | 0,0017 | 0,33 | 0,0594 | 0,0027 | 0,48 | 0,0678 | 0,0022 | 0,48 | 0,0678 | 0,0034 |
| A22- | Strebersdorf | Korneuburg Ost | 1,35 | 0,2424 | 0,0042 | 1,35 | 0,2424 | 0,0067 | 1,90 | 0,3394 | 0,0098 | 1,90 | 0,3394 | 0,0153 | 2,72 | 0,3878 | 0,0123 | 2,73 | 0,3878 | 0,0193 |
| A222 | Strebersdorf | Wien Vohburggasse | 0,17 | 0,0301 | 0,0005 | 0,17 | 0,0301 | 0,0008 | 0,24 | 0,0422 | 0,0012 | 0,24 | 0,0422 | 0,0019 | 0,34 | 0,0482 | 0,0015 | 0,34 | 0,0482 | 0,0024 |
| A22- | Korneuburg Ost | KN Korneuburg | 0,87 | 0,1564 | 0,0027 | 0,87 | 0,1564 | 0,0043 | 1,22 | 0,2190 | 0,0063 | 1,23 | 0,2190 | 0,0099 | 1,75 | 0,2503 | 0,0079 | 1,76 | 0,2503 | 0,0125 |
| A22- | KN Korneuburg | Stockerau Ost | 1,27 | 0,2276 | 0,0040 | 1,27 | 0,2276 | 0,0063 | 1,78 | 0,3186 | 0,0092 | 1,78 | 0,3186 | 0,0144 | 2,55 | 0,3642 | 0,0116 | 2,56 | 0,3642 | 0,0182 |
| A22- | Stockerau Ost | Stockerau Mitte | 0,51 | 0,0908 | 0,0016 | 0,51 | 0,0908 | 0,0025 | 0,71 | 0,1271 | 0,0037 | 0,71 | 0,1271 | 0,0057 | 1,02 | 0,1452 | 0,0046 | 1,02 | 0,1452 | 0,0072 |
| A22- | Stockerau Mitte | KN Stockerau/West | 0,43 | 0,0771 | 0,0013 | 0,43 | 0,0771 | 0,0021 | 0,60 | 0,1079 | 0,0031 | 0,60 | 0,1079 | 0,0049 | 0,86 | 0,1233 | 0,0039 | 0,87 | 0,1233 | 0,0061 |
| A23- | Altmannsdorferstraße | KN Wien Inzersdorf | 0,38 | 0,0674 | 0,0012 | 0,38 | 0,0674 | 0,0019 | 0,53 | 0,0944 | 0,0027 | 0,53 | 0,0944 | 0,0043 | 0,76 | 0,1079 | 0,0034 | 0,76 | 0,1079 | 0,0054 |
| A23- | KN Wien Inzersdorf | Favoriten | 0,95 | 0,1701 | 0,0030 | 0,95 | 0,1701 | 0,0047 | 1,33 | 0,2381 | 0,0068 | 1,33 | 0,2381 | 0,0108 | 1,91 | 0,2721 | 0,0086 | 1,91 | 0,2721 | 0,0136 |
| A23- | Favoriten | KN Gürtel Landstraßer Hauptstraße | 0,59 | 0,1065 | 0,0019 | 0,59 | 0,1065 | 0,0029 | 0,83 | 0,1491 | 0,0043 | 0,84 | 0,1491 | 0,0067 | 1,19 | 0,1704 | 0,0054 | 1,20 | 0,1704 | 0,0085 |
| A23- | KN Gürtel Landstraßer Hauptstraße | St. Marx | 0,23 | 0,0404 | 0,0007 | 0,23 | 0,0404 | 0,0011 | 0,32 | 0,0566 | 0,0016 | 0,32 | 0,0566 | 0,0026 | 0,45 | 0,0647 | 0,0021 | 0,45 | 0,0647 | 0,0032 |
| A23- | St. Marx | KN Wien Prater | 0,19 | 0,0343 | 0,0006 | 0,19 | 0,0343 | 0,0009 | 0,27 | 0,0480 | 0,0014 | 0,27 | 0,0480 | 0,0022 | 0,38 | 0,0549 | 0,0017 | 0,39 | 0,0549 | 0,0027 |
| A23- | KN Wien Prater | Handelskai | 0,42 | 0,0762 | 0,0013 | 0,43 | 0,0762 | 0,0021 | 0,60 | 0,1067 | 0,0031 | 0,60 | 0,1067 | 0,0048 | 0,85 | 0,1219 | 0,0039 | 0,86 | 0,1219 | 0,0061 |
| A23- | Handelskai | KN Wien Kaisermühlen | 0,19 | 0,0348 | 0,0006 | 0,19 | 0,0348 | 0,0010 | 0,27 | 0,0488 | 0,0014 | 0,27 | 0,0488 | 0,0022 | 0,39 | 0,0557 | 0,0018 | 0,39 | 0,0557 | 0,0028 |
| A23- | KN Wien Kaisermühlen | Groß Enzersdorf Stadlau | 0,53 | 0,0956 | 0,0017 | 0,53 | 0,0956 | 0,0026 | 0,75 | 0,1338 | 0,0038 | 0,75 | 0,1338 | 0,0060 | 1,07 | 0,1530 | 0,0049 | 1,08 | 0,1530 | 0,0076 |
| A23- | Groß Enzersdorf Stadlau | Hirschstetten | 0,30 | 0,0536 | 0,0009 | 0,30 | 0,0536 | 0,0015 | 0,42 | 0,0750 | 0,0022 | 0,42 | 0,0750 | 0,0034 | 0,60 | 0,0858 | 0,0027 | 0,60 | 0,0858 | 0,0043 |
| A233 | KN Gürtel Landstraßer Hauptstraße | Wien Gürtel | 0,17 | 0,0313 | 0,0005 | 0,17 | 0,0313 | 0,0009 | 0,24 | 0,0438 | 0,0013 | 0,25 | 0,0438 | 0,0020 | 0,35 | 0,0500 | 0,0016 | 0,35 | 0,0500 | 0,0025 |
| A25- | KN A1/A25 Passau Wels | Weißkirchen | 1,96 | 0,3526 | 0,0062 | 1,97 | 0,3526 | 0,0097 | 2,76 | 0,4936 | 0,0142 | 2,76 | 0,4936 | 0,0223 | 3,95 | 0,5642 | 0,0179 | 3,97 | 0,5642 | 0,0281 |
| A25- | Weißkirchen | Marchtrenk Wels Ost | 0,70 | 0,1256 | 0,0022 | 0,70 | 0,1256 | 0,0035 | 0,98 | 0,1759 | 0,0051 | 0,99 | 0,1759 | 0,0079 | 1,41 | 0,2010 | 0,0064 | 1,41 | 0,2010 | 0,0100 |
| A25- | Marchtrenk Wels Ost | ÖBB Terminal Wels | 0,19 | 0,0338 | 0,0006 | 0,19 | 0,0338 | 0,0009 | 0,26 | 0,0473 | 0,0014 | 0,26 | 0,0473 | 0,0021 | 0,38 | 0,0541 | 0,0017 | 0,38 | 0,0541 | 0,0027 |

| | | | | | | | | | | | | | | | | | | | | |
|------|-----------------------------------|-----------------------------------|------|--------|--------|------|--------|--------|------|--------|--------|------|--------|--------|------|--------|--------|------|--------|--------|
| S01- | Seyring | KN Eibesbrunn | 0,92 | 0,1649 | 0,0029 | 0,92 | 0,1649 | 0,0045 | 1,29 | 0,2308 | 0,0066 | 1,29 | 0,2308 | 0,0104 | 1,85 | 0,2638 | 0,0084 | 1,85 | 0,2638 | 0,0131 |
| S01- | KN Eibesbrunn | Hagenbrunn | 0,72 | 0,1298 | 0,0023 | 0,72 | 0,1298 | 0,0036 | 1,01 | 0,1817 | 0,0052 | 1,02 | 0,1817 | 0,0082 | 1,46 | 0,2077 | 0,0066 | 1,46 | 0,2077 | 0,0104 |
| S01- | Hagenbrunn | Korneuburg Nord | 1,55 | 0,2777 | 0,0049 | 1,55 | 0,2777 | 0,0076 | 2,17 | 0,3888 | 0,0112 | 2,18 | 0,3888 | 0,0176 | 3,11 | 0,4443 | 0,0141 | 3,12 | 0,4443 | 0,0221 |
| S01- | Korneuburg Nord | Korneuburg West | 0,63 | 0,1126 | 0,0020 | 0,63 | 0,1126 | 0,0031 | 0,88 | 0,1577 | 0,0045 | 0,88 | 0,1577 | 0,0071 | 1,26 | 0,1802 | 0,0057 | 1,27 | 0,1802 | 0,0090 |
| S01- | Korneuburg West | KN Korneuburg | 0,20 | 0,0359 | 0,0006 | 0,20 | 0,0359 | 0,0010 | 0,28 | 0,0503 | 0,0014 | 0,28 | 0,0503 | 0,0023 | 0,40 | 0,0575 | 0,0018 | 0,40 | 0,0575 | 0,0029 |
| S02- | Hirschstetten | Gewerbepark Stadlau | 0,22 | 0,0386 | 0,0007 | 0,22 | 0,0386 | 0,0011 | 0,30 | 0,0540 | 0,0016 | 0,30 | 0,0540 | 0,0024 | 0,43 | 0,0618 | 0,0020 | 0,43 | 0,0618 | 0,0031 |
| S02- | Gewerbepark Stadlau | Breitenleer Straße | 0,12 | 0,0214 | 0,0004 | 0,12 | 0,0214 | 0,0006 | 0,17 | 0,0300 | 0,0009 | 0,17 | 0,0300 | 0,0014 | 0,24 | 0,0342 | 0,0011 | 0,24 | 0,0342 | 0,0017 |
| S02- | Breitenleer Straße | Rautenweg | 0,20 | 0,0355 | 0,0006 | 0,20 | 0,0355 | 0,0010 | 0,28 | 0,0497 | 0,0014 | 0,28 | 0,0497 | 0,0022 | 0,40 | 0,0568 | 0,0018 | 0,40 | 0,0568 | 0,0028 |
| S02- | Rautenweg | Hermann Gebauer Straße | 0,22 | 0,0390 | 0,0007 | 0,22 | 0,0390 | 0,0011 | 0,31 | 0,0547 | 0,0016 | 0,31 | 0,0547 | 0,0025 | 0,44 | 0,0625 | 0,0020 | 0,44 | 0,0625 | 0,0031 |
| S02- | Hermann Gebauer Straße | Angerner Straße | 0,79 | 0,1413 | 0,0025 | 0,79 | 0,1413 | 0,0039 | 1,10 | 0,1978 | 0,0057 | 1,11 | 0,1978 | 0,0089 | 1,58 | 0,2260 | 0,0072 | 1,59 | 0,2260 | 0,0113 |
| S03- | KN Stockerau/West | Stockerau Nord | 0,22 | 0,0399 | 0,0007 | 0,22 | 0,0399 | 0,0011 | 0,31 | 0,0559 | 0,0016 | 0,31 | 0,0559 | 0,0025 | 0,45 | 0,0639 | 0,0020 | 0,45 | 0,0639 | 0,0032 |
| S03- | Stockerau Nord | Sierndorf | 1,20 | 0,2146 | 0,0038 | 1,20 | 0,2146 | 0,0059 | 1,68 | 0,3004 | 0,0086 | 1,68 | 0,3004 | 0,0136 | 2,41 | 0,3433 | 0,0109 | 2,41 | 0,3433 | 0,0171 |
| S03- | Sierndorf | Obermallebarn | 0,80 | 0,1441 | 0,0025 | 0,80 | 0,1441 | 0,0040 | 1,13 | 0,2017 | 0,0058 | 1,13 | 0,2017 | 0,0091 | 1,62 | 0,2305 | 0,0073 | 1,62 | 0,2305 | 0,0115 |
| S03- | Obermallebarn | Göllersdorf | 1,06 | 0,1902 | 0,0033 | 1,06 | 0,1902 | 0,0052 | 1,49 | 0,2663 | 0,0077 | 1,49 | 0,2663 | 0,0120 | 2,13 | 0,3044 | 0,0097 | 2,14 | 0,3044 | 0,0152 |
| S03- | Göllersdorf | Großstelzendorf | 0,42 | 0,0762 | 0,0013 | 0,43 | 0,0762 | 0,0021 | 0,60 | 0,1067 | 0,0031 | 0,60 | 0,1067 | 0,0048 | 0,85 | 0,1219 | 0,0039 | 0,86 | 0,1219 | 0,0061 |
| S03- | Großstelzendorf | Hollabrunn Süd | 1,02 | 0,1832 | 0,0032 | 1,02 | 0,1832 | 0,0050 | 1,43 | 0,2565 | 0,0074 | 1,44 | 0,2565 | 0,0116 | 2,06 | 0,2932 | 0,0093 | 2,06 | 0,2932 | 0,0146 |
| S04- | KN Mattersburg | Sigleß | 0,53 | 0,0947 | 0,0017 | 0,53 | 0,0947 | 0,0026 | 0,74 | 0,1326 | 0,0038 | 0,74 | 0,1326 | 0,0060 | 1,06 | 0,1516 | 0,0048 | 1,07 | 0,1516 | 0,0076 |
| S04- | Sigleß | Bad Sauerbrunn | 1,23 | 0,2213 | 0,0039 | 1,24 | 0,2213 | 0,0061 | 1,73 | 0,3098 | 0,0089 | 1,74 | 0,3098 | 0,0140 | 2,48 | 0,3541 | 0,0112 | 2,49 | 0,3541 | 0,0177 |
| S04- | Bad Sauerbrunn | Neudörfel | 0,52 | 0,0930 | 0,0016 | 0,52 | 0,0930 | 0,0026 | 0,73 | 0,1302 | 0,0037 | 0,73 | 0,1302 | 0,0059 | 1,04 | 0,1488 | 0,0047 | 1,05 | 0,1488 | 0,0074 |
| S04- | Neudörfel | Wr. Neustadt Ost | 0,54 | 0,0974 | 0,0017 | 0,54 | 0,0974 | 0,0027 | 0,76 | 0,1363 | 0,0039 | 0,76 | 0,1363 | 0,0062 | 1,09 | 0,1558 | 0,0049 | 1,09 | 0,1558 | 0,0078 |
| S04- | Wr. Neustadt Ost | Katzelsdorf | 0,25 | 0,0456 | 0,0008 | 0,25 | 0,0456 | 0,0013 | 0,36 | 0,0638 | 0,0018 | 0,36 | 0,0638 | 0,0029 | 0,51 | 0,0730 | 0,0023 | 0,51 | 0,0730 | 0,0036 |
| S04- | Katzelsdorf | Lanzenkirchen | 0,21 | 0,0382 | 0,0007 | 0,21 | 0,0382 | 0,0010 | 0,30 | 0,0534 | 0,0015 | 0,30 | 0,0534 | 0,0024 | 0,43 | 0,0611 | 0,0019 | 0,43 | 0,0611 | 0,0030 |
| S04- | Lanzenkirchen | Wr. Neustadt Süd | 0,19 | 0,0338 | 0,0006 | 0,19 | 0,0338 | 0,0009 | 0,26 | 0,0474 | 0,0014 | 0,27 | 0,0474 | 0,0021 | 0,38 | 0,0541 | 0,0017 | 0,38 | 0,0541 | 0,0027 |
| S04- | Wr. Neustadt Süd | KN Wr. Neustadt | 0,31 | 0,0560 | 0,0010 | 0,31 | 0,0560 | 0,0015 | 0,44 | 0,0784 | 0,0023 | 0,44 | 0,0784 | 0,0035 | 0,63 | 0,0896 | 0,0028 | 0,63 | 0,0896 | 0,0045 |
| S05- | KN Stockerau/West | Tulln | 2,15 | 0,3864 | 0,0068 | 2,16 | 0,3864 | 0,0106 | 3,02 | 0,5410 | 0,0156 | 3,03 | 0,5410 | 0,0244 | 4,33 | 0,6182 | 0,0196 | 4,35 | 0,6182 | 0,0308 |
| S05- | Tulln | Königsbrunn / Wagram | 2,70 | 0,4840 | 0,0085 | 2,70 | 0,4840 | 0,0133 | 3,78 | 0,6776 | 0,0195 | 3,79 | 0,6776 | 0,0306 | 5,43 | 0,7744 | 0,0246 | 5,44 | 0,7744 | 0,0386 |
| S05- | Königsbrunn / Wagram | Kirchberg/Wagram | 0,72 | 0,1290 | 0,0023 | 0,72 | 0,1290 | 0,0035 | 1,01 | 0,1806 | 0,0052 | 1,01 | 0,1806 | 0,0082 | 1,45 | 0,2064 | 0,0065 | 1,45 | 0,2064 | 0,0103 |
| S05- | Kirchberg/Wagram | Fels / Wagram | 0,54 | 0,0966 | 0,0017 | 0,54 | 0,0966 | 0,0027 | 0,76 | 0,1353 | 0,0039 | 0,76 | 0,1353 | 0,0061 | 1,08 | 0,1546 | 0,0049 | 1,09 | 0,1546 | 0,0077 |
| S05- | Fels / Wagram | Grafenwörth | 1,24 | 0,2225 | 0,0039 | 1,24 | 0,2225 | 0,0061 | 1,74 | 0,3115 | 0,0090 | 1,74 | 0,3115 | 0,0141 | 2,50 | 0,3560 | 0,0113 | 2,50 | 0,3560 | 0,0177 |
| S05- | Grafenwörth | Jettsdorf | 0,55 | 0,0995 | 0,0017 | 0,56 | 0,0995 | 0,0027 | 0,78 | 0,1393 | 0,0040 | 0,78 | 0,1393 | 0,0063 | 1,12 | 0,1592 | 0,0050 | 1,12 | 0,1592 | 0,0079 |
| S06- | KN Seebebenstein | Neunkirchen | 0,85 | 0,1518 | 0,0027 | 0,85 | 0,1518 | 0,0042 | 1,19 | 0,2125 | 0,0061 | 1,19 | 0,2125 | 0,0096 | 1,70 | 0,2429 | 0,0077 | 1,71 | 0,2429 | 0,0121 |
| S06- | Neunkirchen | Gloggnitz | 2,71 | 0,4868 | 0,0085 | 2,72 | 0,4868 | 0,0134 | 3,81 | 0,6815 | 0,0196 | 3,82 | 0,6815 | 0,0308 | 5,46 | 0,7789 | 0,0247 | 5,47 | 0,7789 | 0,0388 |
| S06- | Gloggnitz | Maria Schutz | 1,73 | 0,3103 | 0,0054 | 1,73 | 0,3103 | 0,0085 | 2,43 | 0,4344 | 0,0125 | 2,43 | 0,4344 | 0,0196 | 3,48 | 0,4964 | 0,0157 | 3,49 | 0,4964 | 0,0247 |
| S06- | Maria Schutz | Spital / Semmering | 1,47 | 0,2634 | 0,0046 | 1,47 | 0,2634 | 0,0072 | 2,06 | 0,3687 | 0,0106 | 2,06 | 0,3687 | 0,0167 | 2,95 | 0,4214 | 0,0134 | 2,96 | 0,4214 | 0,0210 |
| S06- | Spital / Semmering | Mürzzuschlag Ost | 1,23 | 0,2200 | 0,0039 | 1,23 | 0,2200 | 0,0061 | 1,72 | 0,3080 | 0,0089 | 1,72 | 0,3080 | 0,0139 | 2,47 | 0,3520 | 0,0112 | 2,47 | 0,3520 | 0,0175 |
| S06- | Mürzzuschlag Ost | Mariazell, Mürzsteg, Mürzzuschlag | 1,09 | 0,1950 | 0,0034 | 1,09 | 0,1950 | 0,0054 | 1,52 | 0,2731 | 0,0079 | 1,53 | 0,2731 | 0,0123 | 2,19 | 0,3121 | 0,0099 | 2,19 | 0,3121 | 0,0156 |
| S06- | Mariazell, Mürzsteg, Mürzzuschlag | Hönigsberg | 0,78 | 0,1391 | 0,0024 | 0,78 | 0,1391 | 0,0038 | 1,09 | 0,1947 | 0,0056 | 1,09 | 0,1947 | 0,0088 | 1,56 | 0,2225 | 0,0071 | 1,56 | 0,2225 | 0,0111 |
| S06- | Hönigsberg | Langenwang | 0,43 | 0,0769 | 0,0013 | 0,43 | 0,0769 | 0,0021 | 0,60 | 0,1077 | 0,0031 | 0,60 | 0,1077 | 0,0049 | 0,86 | 0,1231 | 0,0039 | 0,87 | 0,1231 | 0,0061 |
| S06- | Langenwang | Krieglach | 0,51 | 0,0914 | 0,0016 | 0,51 | 0,0914 | 0,0025 | 0,71 | 0,1279 | 0,0037 | 0,72 | 0,1279 | 0,0058 | 1,02 | 0,1462 | 0,0046 | 1,03 | 0,1462 | 0,0073 |
| S06- | Krieglach | Mitterdorf | 1,29 | 0,2309 | 0,0040 | 1,29 | 0,2309 | 0,0064 | 1,81 | 0,3233 | 0,0093 | 1,81 | 0,3233 | 0,0146 | 2,59 | 0,3695 | 0,0117 | 2,60 | 0,3695 | 0,0184 |
| S06- | Mitterdorf | Kindberg Ost | 1,31 | 0,2348 | 0,0041 | 1,31 | 0,2348 | 0,0065 | 1,84 | 0,3287 | 0,0095 | 1,84 | 0,3287 | 0,0149 | 2,63 | 0,3757 | 0,0119 | 2,64 | 0,3757 | 0,0187 |
| S06- | Kindberg Ost | Kindberg West | 0,28 | 0,0504 | 0,0009 | 0,28 | 0,0504 | 0,0014 | 0,39 | 0,0706 | 0,0020 | 0,40 | 0,0706 | 0,0032 | 0,57 | 0,0806 | 0,0026 | 0,57 | 0,0806 | 0,0040 |
| S06- | Kindberg West | Kindberg Dörfel | 0,28 | 0,0504 | 0,0009 | 0,28 | 0,0504 | 0,0014 | 0,39 | 0,0705 | 0,0020 | 0,39 | 0,0705 | 0,0032 | 0,56 | 0,0806 | 0,0026 | 0,57 | 0,0806 | 0,0040 |
| S06- | Kindberg Dörfel | Allerheiligen Mürzhofen | 0,63 | 0,1134 | 0,0020 | 0,63 | 0,1134 | 0,0031 | 0,89 | 0,1588 | 0,0046 | 0,89 | 0,1588 | 0,0072 | 1,27 | 0,1815 | 0,0058 | 1,28 | 0,1815 | 0,0090 |
| S06- | Allerheiligen Mürzhofen | St. Marein | 0,95 | 0,1704 | 0,0030 | 0,95 | 0,1704 | 0,0047 | 1,33 | 0,2386 | 0,0069 | 1,34 | 0,2386 | 0,0108 | 1,91 | 0,2726 | 0,0086 | 1,92 | 0,2726 | 0,0136 |
| S06- | St. Marein | Kapfenberg | 0,67 | 0,1208 | 0,0021 | 0,67 | 0,1208 | 0,0033 | 0,94 | 0,1691 | 0,0049 | 0,95 | 0,1691 | 0,0076 | 1,35 | 0,1933 | 0,0061 | 1,36 | 0,1933 | 0,0096 |
| S06- | Kapfenberg | KN Bruck/Mur | 1,26 | 0,2255 | 0,0039 | 1,26 | 0,2255 | 0,0062 | 1,76 | 0,3157 | 0,0091 | 1,77 | 0,3157 | 0,0143 | 2,53 | 0,3608 | 0,0114 | 2,54 | 0,3608 | 0,0180 |
| S06- | KN Bruck/Mur | ASt Bruck/Mur | 1,08 | 0,1934 | 0,0034 | 1,08 | 0,1934 | 0,0053 | 1,51 | 0,2708 | 0,0078 | 1,52 | 0,2708 | 0,0122 | 2,17 | 0,3095 | 0,0098 | 2,18 | 0,3095 | 0,0154 |
| S06- | ASt Bruck/Mur | Niklasdorf | 1,00 | 0,1787 | 0,0031 | 1,00 | 0,1787 | 0,0049 | 1,40 | 0,2502 | 0,0072 | 1,40 | 0,2502 | 0,0113 | 2,00 | 0,2860 | 0,0091 | 2,01 | 0,2860 | 0,0143 |
| S06- | Niklasdorf | Leoben Ost | 1,06 | 0,1906 | 0,0033 | 1,06 | 0,1906 | 0,0052 | 1,49 | 0,2669 | 0,0077 | 1,49 | 0,2669 | 0,0121 | 2,14 | 0,3050 | 0,0097 | 2,14 | 0,3050 | 0,0152 |
| S06- | Leoben Ost | Leoben West | 1,19 | 0,2136 | 0,0037 | 1,19 | 0,2136 | 0,0059 | 1,67 | 0,2990 | 0,0086 | 1,67 | 0,2990 | 0,0135 | 2,40 | 0,3417 | 0,0108 | 2,40 | 0,3417 | |

| | | | | | | | | | | | | | | | | | | | | |
|------|-----------------------------|-----------------------------|------|--------|--------|------|--------|--------|------|--------|--------|------|--------|--------|------|--------|--------|------|--------|--------|
| S31- | Eisenstadt Mitte | KN Eisenstadt | 0,42 | 0,0761 | 0,0013 | 0,42 | 0,0761 | 0,0021 | 0,59 | 0,1065 | 0,0031 | 0,60 | 0,1065 | 0,0048 | 0,85 | 0,1217 | 0,0039 | 0,86 | 0,1217 | 0,0061 |
| S31- | KN Eisenstadt | Wulkaprodersdorf | 0,56 | 0,1013 | 0,0018 | 0,57 | 0,1013 | 0,0028 | 0,79 | 0,1418 | 0,0041 | 0,79 | 0,1418 | 0,0064 | 1,14 | 0,1620 | 0,0051 | 1,14 | 0,1620 | 0,0081 |
| S31- | Wulkaprodersdorf | KN Mattersburg | 1,60 | 0,2875 | 0,0050 | 1,61 | 0,2875 | 0,0079 | 2,25 | 0,4025 | 0,0116 | 2,25 | 0,4025 | 0,0182 | 3,22 | 0,4600 | 0,0146 | 3,23 | 0,4600 | 0,0229 |
| S31- | KN Mattersburg | Forchtenstein | 1,16 | 0,2081 | 0,0036 | 1,16 | 0,2081 | 0,0057 | 1,63 | 0,2914 | 0,0084 | 1,63 | 0,2914 | 0,0132 | 2,33 | 0,3330 | 0,0106 | 2,34 | 0,3330 | 0,0166 |
| S31- | Forchtenstein | Sieggraben | 1,62 | 0,2908 | 0,0051 | 1,62 | 0,2908 | 0,0080 | 2,27 | 0,4071 | 0,0117 | 2,28 | 0,4071 | 0,0184 | 3,26 | 0,4653 | 0,0148 | 3,27 | 0,4653 | 0,0232 |
| S31- | Sieggraben | Weppersdorf/Kobersdorf | 1,95 | 0,3503 | 0,0061 | 1,96 | 0,3503 | 0,0096 | 2,74 | 0,4904 | 0,0141 | 2,75 | 0,4904 | 0,0222 | 3,93 | 0,5605 | 0,0178 | 3,94 | 0,5605 | 0,0279 |
| S31- | Weppersdorf/Kobersdorf | Weppersdorf/Markt St.Martin | 0,40 | 0,0720 | 0,0013 | 0,40 | 0,0720 | 0,0020 | 0,56 | 0,1007 | 0,0029 | 0,56 | 0,1007 | 0,0046 | 0,81 | 0,1151 | 0,0037 | 0,81 | 0,1151 | 0,0057 |
| S31- | Weppersdorf/Markt St.Martin | Neutal | 0,93 | 0,1663 | 0,0029 | 0,93 | 0,1663 | 0,0046 | 1,30 | 0,2328 | 0,0067 | 1,30 | 0,2328 | 0,0105 | 1,87 | 0,2660 | 0,0084 | 1,87 | 0,2660 | 0,0133 |
| S31- | Neutal | Stoob Süd | 0,81 | 0,1453 | 0,0025 | 0,81 | 0,1453 | 0,0040 | 1,14 | 0,2034 | 0,0058 | 1,14 | 0,2034 | 0,0092 | 1,63 | 0,2324 | 0,0074 | 1,63 | 0,2324 | 0,0116 |
| S31- | Stoob Süd | Oberpullendorf | 0,88 | 0,1586 | 0,0028 | 0,89 | 0,1586 | 0,0044 | 1,24 | 0,2220 | 0,0064 | 1,24 | 0,2220 | 0,0100 | 1,78 | 0,2538 | 0,0080 | 1,78 | 0,2538 | 0,0126 |
| S33- | KN St. Pölten | St. Pölten Ost | 0,48 | 0,0861 | 0,0015 | 0,48 | 0,0861 | 0,0024 | 0,67 | 0,1205 | 0,0035 | 0,67 | 0,1205 | 0,0054 | 0,97 | 0,1377 | 0,0044 | 0,97 | 0,1377 | 0,0069 |
| S33- | St. Pölten Ost | St. Pölten Nord | 0,85 | 0,1521 | 0,0027 | 0,85 | 0,1521 | 0,0042 | 1,19 | 0,2130 | 0,0061 | 1,19 | 0,2130 | 0,0096 | 1,71 | 0,2434 | 0,0077 | 1,71 | 0,2434 | 0,0121 |
| S33- | St. Pölten Nord | Herzogenburg Süd | 0,90 | 0,1611 | 0,0028 | 0,90 | 0,1611 | 0,0044 | 1,26 | 0,2255 | 0,0065 | 1,26 | 0,2255 | 0,0102 | 1,81 | 0,2577 | 0,0082 | 1,81 | 0,2577 | 0,0128 |
| S33- | Herzogenburg Süd | Herzogenburg Stadt | 0,48 | 0,0860 | 0,0015 | 0,48 | 0,0860 | 0,0024 | 0,67 | 0,1204 | 0,0035 | 0,67 | 0,1204 | 0,0054 | 0,96 | 0,1376 | 0,0044 | 0,97 | 0,1376 | 0,0069 |
| S33- | Herzogenburg Stadt | Herzogenburg Nord | 0,27 | 0,0477 | 0,0008 | 0,27 | 0,0477 | 0,0013 | 0,37 | 0,0668 | 0,0019 | 0,37 | 0,0668 | 0,0030 | 0,53 | 0,0763 | 0,0024 | 0,54 | 0,0763 | 0,0038 |
| S33- | Herzogenburg Nord | Traismauer Süd | 1,29 | 0,2320 | 0,0041 | 1,30 | 0,2320 | 0,0064 | 1,81 | 0,3249 | 0,0093 | 1,82 | 0,3249 | 0,0147 | 2,60 | 0,3713 | 0,0118 | 2,61 | 0,3713 | 0,0185 |
| S33- | Traismauer Süd | Traismauer Nord | 0,66 | 0,1180 | 0,0021 | 0,66 | 0,1180 | 0,0032 | 0,92 | 0,1652 | 0,0047 | 0,93 | 0,1652 | 0,0075 | 1,32 | 0,1888 | 0,0060 | 1,33 | 0,1888 | 0,0094 |
| S33- | Traismauer Nord | Jettsdorf | 1,11 | 0,1993 | 0,0035 | 1,11 | 0,1993 | 0,0055 | 1,56 | 0,2790 | 0,0080 | 1,56 | 0,2790 | 0,0126 | 2,24 | 0,3188 | 0,0101 | 2,24 | 0,3188 | 0,0159 |
| S35- | KN Bruck/Mur | Pernegg | 1,36 | 0,2436 | 0,0043 | 1,36 | 0,2436 | 0,0067 | 1,90 | 0,3410 | 0,0098 | 1,91 | 0,3410 | 0,0154 | 2,73 | 0,3898 | 0,0124 | 2,74 | 0,3898 | 0,0194 |
| S35- | Pernegg | Mixnitz/Mautstatt | 0,99 | 0,1772 | 0,0031 | 0,99 | 0,1772 | 0,0049 | 1,38 | 0,2480 | 0,0071 | 1,39 | 0,2480 | 0,0112 | 1,99 | 0,2835 | 0,0090 | 1,99 | 0,2835 | 0,0141 |
| S35- | Mixnitz/Mautstatt | Röthelstein | 1,18 | 0,2124 | 0,0037 | 1,19 | 0,2124 | 0,0058 | 1,66 | 0,2974 | 0,0085 | 1,67 | 0,2974 | 0,0134 | 2,38 | 0,3398 | 0,0108 | 2,39 | 0,3398 | 0,0169 |
| S35- | Röthelstein | Laufnitzdorf | 0,57 | 0,1024 | 0,0018 | 0,57 | 0,1024 | 0,0028 | 0,80 | 0,1433 | 0,0041 | 0,80 | 0,1433 | 0,0065 | 1,15 | 0,1638 | 0,0052 | 1,15 | 0,1638 | 0,0082 |
| S35- | Laufnitzdorf | Rothleiten | 0,65 | 0,1164 | 0,0020 | 0,65 | 0,1164 | 0,0032 | 0,91 | 0,1629 | 0,0047 | 0,91 | 0,1629 | 0,0074 | 1,31 | 0,1862 | 0,0059 | 1,31 | 0,1862 | 0,0093 |
| S35- | Rothleiten | Frohnleiten Nord | 0,40 | 0,0725 | 0,0013 | 0,40 | 0,0725 | 0,0020 | 0,57 | 0,1015 | 0,0029 | 0,57 | 0,1015 | 0,0046 | 0,81 | 0,1160 | 0,0037 | 0,82 | 0,1160 | 0,0058 |
| S35- | Frohnleiten Nord | Frohnleiten | 0,19 | 0,0334 | 0,0006 | 0,19 | 0,0334 | 0,0009 | 0,26 | 0,0468 | 0,0013 | 0,26 | 0,0468 | 0,0021 | 0,38 | 0,0535 | 0,0017 | 0,38 | 0,0535 | 0,0027 |
| S35- | Frohnleiten | Badl Peggau | 1,25 | 0,2248 | 0,0039 | 1,26 | 0,2248 | 0,0062 | 1,76 | 0,3147 | 0,0090 | 1,76 | 0,3147 | 0,0142 | 2,52 | 0,3597 | 0,0114 | 2,53 | 0,3597 | 0,0179 |
| S35- | Badl Peggau | Peggau Mitte | 0,42 | 0,0752 | 0,0013 | 0,42 | 0,0752 | 0,0021 | 0,59 | 0,1053 | 0,0030 | 0,59 | 0,1053 | 0,0048 | 0,84 | 0,1203 | 0,0038 | 0,85 | 0,1203 | 0,0060 |
| S35- | Peggau Mitte | KN Peggau Deutschfeistritz | 0,87 | 0,1566 | 0,0027 | 0,87 | 0,1566 | 0,0043 | 1,22 | 0,2192 | 0,0063 | 1,23 | 0,2192 | 0,0099 | 1,76 | 0,2506 | 0,0079 | 1,76 | 0,2506 | 0,0125 |
| S36- | KN St. Michael | St. Stefan ob Leoben | 0,72 | 0,1290 | 0,0023 | 0,72 | 0,1290 | 0,0035 | 1,01 | 0,1806 | 0,0052 | 1,01 | 0,1806 | 0,0082 | 1,45 | 0,2064 | 0,0065 | 1,45 | 0,2064 | 0,0103 |
| S36- | St. Stefan ob Leoben | Kraubath | 0,77 | 0,1386 | 0,0024 | 0,77 | 0,1386 | 0,0038 | 1,08 | 0,1940 | 0,0056 | 1,09 | 0,1940 | 0,0088 | 1,55 | 0,2218 | 0,0070 | 1,56 | 0,2218 | 0,0111 |
| S36- | Kraubath | Feistritz St. Lorenzen | 1,36 | 0,2435 | 0,0043 | 1,36 | 0,2435 | 0,0067 | 1,90 | 0,3409 | 0,0098 | 1,91 | 0,3409 | 0,0154 | 2,73 | 0,3896 | 0,0124 | 2,74 | 0,3896 | 0,0194 |
| S36- | Feistritz St. Lorenzen | Knittelfeld Ost | 1,56 | 0,2795 | 0,0049 | 1,56 | 0,2795 | 0,0077 | 2,18 | 0,3913 | 0,0112 | 2,19 | 0,3913 | 0,0177 | 3,13 | 0,4472 | 0,0142 | 3,14 | 0,4472 | 0,0223 |
| S36- | Knittelfeld Ost | Knittelfeld West | 0,66 | 0,1185 | 0,0021 | 0,66 | 0,1185 | 0,0033 | 0,93 | 0,1659 | 0,0048 | 0,93 | 0,1659 | 0,0075 | 1,33 | 0,1896 | 0,0060 | 1,33 | 0,1896 | 0,0095 |
| S36- | Knittelfeld West | Zeitweg Ost Spielberg | 0,21 | 0,0370 | 0,0006 | 0,21 | 0,0370 | 0,0010 | 0,29 | 0,0518 | 0,0015 | 0,29 | 0,0518 | 0,0023 | 0,42 | 0,0592 | 0,0019 | 0,42 | 0,0592 | 0,0030 |
| S36- | Zeitweg Ost Spielberg | Zeitweg West | 1,34 | 0,2408 | 0,0042 | 1,34 | 0,2408 | 0,0066 | 1,88 | 0,3371 | 0,0097 | 1,89 | 0,3371 | 0,0152 | 2,70 | 0,3853 | 0,0122 | 2,71 | 0,3853 | 0,0192 |
| S36- | Zeitweg West | Judenburg Ost Fohnsdorf | 0,67 | 0,1211 | 0,0021 | 0,68 | 0,1211 | 0,0033 | 0,95 | 0,1695 | 0,0049 | 0,95 | 0,1695 | 0,0077 | 1,36 | 0,1937 | 0,0061 | 1,36 | 0,1937 | 0,0097 |
| S36- | Judenburg Ost Fohnsdorf | Judenburg West | 1,05 | 0,1878 | 0,0033 | 1,05 | 0,1878 | 0,0052 | 1,47 | 0,2630 | 0,0076 | 1,47 | 0,2630 | 0,0119 | 2,11 | 0,3005 | 0,0095 | 2,11 | 0,3005 | 0,0150 |
| S36- | As B317 (prov.) | St. Georgen Ost | 0,11 | 0,0196 | 0,0003 | 0,11 | 0,0196 | 0,0005 | 0,15 | 0,0275 | 0,0008 | 0,15 | 0,0275 | 0,0012 | 0,22 | 0,0314 | 0,0010 | 0,22 | 0,0314 | 0,0016 |
| S36- | St. Georgen Ost | St. Georgen West | 0,20 | 0,0364 | 0,0006 | 0,20 | 0,0364 | 0,0010 | 0,28 | 0,0509 | 0,0015 | 0,29 | 0,0509 | 0,0023 | 0,41 | 0,0582 | 0,0018 | 0,41 | 0,0582 | 0,0029 |
| S37- | St. Veit Nord | St. Veit Mitte / Brückl | 0,63 | 0,1139 | 0,0020 | 0,64 | 0,1139 | 0,0031 | 0,89 | 0,1595 | 0,0046 | 0,89 | 0,1595 | 0,0072 | 1,28 | 0,1823 | 0,0058 | 1,28 | 0,1823 | 0,0091 |
| S37- | St. Veit Mitte / Brückl | St. Veit Süd | 0,54 | 0,0968 | 0,0017 | 0,54 | 0,0968 | 0,0027 | 0,76 | 0,1356 | 0,0039 | 0,76 | 0,1356 | 0,0061 | 1,09 | 0,1549 | 0,0049 | 1,09 | 0,1549 | 0,0077 |
| S37- | St. Veit Süd | St. Veit Industriegebiet | 0,41 | 0,0728 | 0,0013 | 0,41 | 0,0728 | 0,0020 | 0,57 | 0,1019 | 0,0029 | 0,57 | 0,1019 | 0,0046 | 0,82 | 0,1165 | 0,0037 | 0,82 | 0,1165 | 0,0058 |
| S37- | St. Veit Industriegebiet | Maria Saal | 1,42 | 0,2555 | 0,0045 | 1,43 | 0,2555 | 0,0070 | 2,00 | 0,3577 | 0,0103 | 2,00 | 0,3577 | 0,0162 | 2,87 | 0,4088 | 0,0130 | 2,87 | 0,4088 | 0,0204 |
| S37- | Maria Saal | Karnburg | 0,51 | 0,0912 | 0,0016 | 0,51 | 0,0912 | 0,0025 | 0,71 | 0,1277 | 0,0037 | 0,72 | 0,1277 | 0,0058 | 1,02 | 0,1460 | 0,0046 | 1,03 | 0,1460 | 0,0073 |
| S37- | Karnburg | Klagenfurt Nord | 0,44 | 0,0796 | 0,0014 | 0,44 | 0,0796 | 0,0022 | 0,62 | 0,1115 | 0,0032 | 0,62 | 0,1115 | 0,0050 | 0,89 | 0,1274 | 0,0040 | 0,90 | 0,1274 | 0,0064 |
| A01- | Preßbaum | Wien Auhof | 3,11 | 0,5572 | 0,0098 | 3,11 | 0,5572 | 0,0153 | 4,36 | 0,7801 | 0,0224 | 4,37 | 0,7801 | 0,0352 | 6,25 | 0,8915 | 0,0283 | 6,27 | 0,8915 | 0,0444 |
| A01- | KN Steinhäusl | Preßbaum | 1,75 | 0,3149 | 0,0055 | 1,76 | 0,3149 | 0,0087 | 2,46 | 0,4408 | 0,0127 | 2,47 | 0,4408 | 0,0199 | 3,53 | 0,5038 | 0,0160 | 3,54 | 0,5038 | 0,0251 |
| A01- | Alltengbach | KN Steinhäusl | 1,03 | 0,1851 | 0,0032 | 1,03 | 0,1851 | 0,0051 | 1,45 | 0,2592 | 0,0075 | 1,45 | 0,2592 | 0,0117 | 2,08 | 0,2962 | 0,0094 | 2,08 | 0,2962 | 0,0148 |
| A01- | St. Christophen | Alltengbach | 1,23 | 0,2208 | 0,0039 | 1,23 | 0,2208 | 0,0061 | 1,73 | 0,3091 | 0,0089 | 1,73 | 0,3091 | 0,0140 | 2,48 | 0,3532 | 0,0112 | 2,48 | 0,3532 | 0,0176 |
| A01- | Böheimkirchen | St. Christophen | 1,48 | 0,2648 | 0,0046 | 1,48 | 0,2648 | 0,0073 | 2,07 | 0,3707 | 0,0107 | 2,08 | 0,3707 | 0,0167 | 2,97 | 0,4236 | 0,0134 | 2,98 | 0,4236 | 0,0211 |
| A01- | KN St. Pölten | Böheimkirchen | 1,44 | 0,2590 | 0,0045 | 1,45 | 0,2590 | 0,0071 | 2,02 | 0,3626 | 0,0104 | 2,03 | 0,3626 | 0,0164 | 2,91 | 0,4144 | 0,0131 | | | |

| | | | | | | | | | | | | | | | | | | | | |
|------|----------------------------|----------------------------|------|--------|--------|------|--------|--------|------|--------|--------|------|--------|--------|------|--------|--------|------|--------|--------|
| A01- | Laakirchen West | Laakirchen Ost | 0,81 | 0,1448 | 0,0025 | 0,81 | 0,1448 | 0,0040 | 1,13 | 0,2027 | 0,0058 | 1,14 | 0,2027 | 0,0092 | 1,62 | 0,2317 | 0,0073 | 1,63 | 0,2317 | 0,0115 |
| A01- | Regau | Laakirchen West | 1,58 | 0,2838 | 0,0050 | 1,58 | 0,2838 | 0,0078 | 2,22 | 0,3974 | 0,0114 | 2,23 | 0,3974 | 0,0180 | 3,18 | 0,4541 | 0,0144 | 3,19 | 0,4541 | 0,0226 |
| A01- | Schörfling | Regau | 2,08 | 0,3730 | 0,0065 | 2,08 | 0,3730 | 0,0103 | 2,92 | 0,5221 | 0,0150 | 2,92 | 0,5221 | 0,0236 | 4,18 | 0,5967 | 0,0189 | 4,19 | 0,5967 | 0,0297 |
| A01- | Seewalchen | Schörfling | 0,32 | 0,0578 | 0,0010 | 0,32 | 0,0578 | 0,0016 | 0,45 | 0,0809 | 0,0023 | 0,45 | 0,0809 | 0,0037 | 0,65 | 0,0925 | 0,0029 | 0,65 | 0,0925 | 0,0046 |
| A01- | St. Georgen | Seewalchen | 1,88 | 0,3381 | 0,0059 | 1,89 | 0,3381 | 0,0093 | 2,64 | 0,4733 | 0,0136 | 2,65 | 0,4733 | 0,0214 | 3,79 | 0,5409 | 0,0172 | 3,80 | 0,5409 | 0,0270 |
| A01- | Oberwang | St. Georgen | 2,51 | 0,4508 | 0,0079 | 2,52 | 0,4508 | 0,0124 | 3,52 | 0,6311 | 0,0181 | 3,53 | 0,6311 | 0,0285 | 5,06 | 0,7213 | 0,0229 | 5,07 | 0,7213 | 0,0360 |
| A01- | Mondsee | Oberwang | 2,31 | 0,4149 | 0,0073 | 2,32 | 0,4149 | 0,0114 | 3,24 | 0,5809 | 0,0167 | 3,25 | 0,5809 | 0,0262 | 4,65 | 0,6639 | 0,0211 | 4,67 | 0,6639 | 0,0331 |
| A01- | Thalgau | Mondsee | 2,13 | 0,3825 | 0,0067 | 2,14 | 0,3825 | 0,0105 | 2,99 | 0,5355 | 0,0154 | 3,00 | 0,5355 | 0,0242 | 4,29 | 0,6120 | 0,0194 | 4,30 | 0,6120 | 0,0305 |
| A01- | Wallersee | Thalgau | 1,62 | 0,2915 | 0,0051 | 1,63 | 0,2915 | 0,0080 | 2,28 | 0,4081 | 0,0117 | 2,29 | 0,4081 | 0,0184 | 3,27 | 0,4664 | 0,0148 | 3,28 | 0,4664 | 0,0232 |
| A01- | Salzburg Nord | Wallersee | 1,57 | 0,2822 | 0,0049 | 1,58 | 0,2822 | 0,0078 | 2,21 | 0,3950 | 0,0114 | 2,21 | 0,3950 | 0,0178 | 3,16 | 0,4515 | 0,0143 | 3,17 | 0,4515 | 0,0225 |
| A01- | Salzburg Bergheim-West | Salzburg Nord | 0,35 | 0,0636 | 0,0011 | 0,36 | 0,0636 | 0,0017 | 0,50 | 0,0890 | 0,0026 | 0,50 | 0,0890 | 0,0040 | 0,71 | 0,1018 | 0,0032 | 0,72 | 0,1018 | 0,0051 |
| A01- | Messe | Salzburg Bergheim-West | 0,17 | 0,0304 | 0,0005 | 0,17 | 0,0304 | 0,0008 | 0,24 | 0,0426 | 0,0012 | 0,24 | 0,0426 | 0,0019 | 0,34 | 0,0487 | 0,0015 | 0,34 | 0,0487 | 0,0024 |
| A01- | Salzburg Mitte Freilassing | Messe | 0,23 | 0,0405 | 0,0007 | 0,23 | 0,0405 | 0,0011 | 0,32 | 0,0567 | 0,0016 | 0,32 | 0,0567 | 0,0026 | 0,45 | 0,0648 | 0,0021 | 0,46 | 0,0648 | 0,0032 |
| A01- | Kleßheim | Salzburg Mitte Freilassing | 0,28 | 0,0497 | 0,0009 | 0,28 | 0,0497 | 0,0014 | 0,39 | 0,0696 | 0,0020 | 0,39 | 0,0696 | 0,0031 | 0,56 | 0,0796 | 0,0025 | 0,56 | 0,0796 | 0,0040 |
| A01- | Siezenheim | Kleßheim | 0,38 | 0,0689 | 0,0012 | 0,38 | 0,0689 | 0,0019 | 0,54 | 0,0965 | 0,0028 | 0,54 | 0,0965 | 0,0044 | 0,77 | 0,1103 | 0,0035 | 0,78 | 0,1103 | 0,0055 |
| A01- | Flughafen | Siezenheim | 0,19 | 0,0346 | 0,0006 | 0,19 | 0,0346 | 0,0010 | 0,27 | 0,0485 | 0,0014 | 0,27 | 0,0485 | 0,0022 | 0,39 | 0,0554 | 0,0018 | 0,39 | 0,0554 | 0,0028 |
| A01- | Wals Salzburg West | Flughafen | 0,24 | 0,0424 | 0,0007 | 0,24 | 0,0424 | 0,0012 | 0,33 | 0,0593 | 0,0017 | 0,33 | 0,0593 | 0,0027 | 0,48 | 0,0678 | 0,0021 | 0,48 | 0,0678 | 0,0034 |
| A01- | KN Salzburg | Wals Salzburg West | 0,35 | 0,0634 | 0,0011 | 0,35 | 0,0634 | 0,0017 | 0,50 | 0,0888 | 0,0026 | 0,50 | 0,0888 | 0,0040 | 0,71 | 0,1014 | 0,0032 | 0,71 | 0,1014 | 0,0051 |
| A01- | Staatsgrenze Walsberg | KN Salzburg | 0,60 | 0,1077 | 0,0019 | 0,60 | 0,1077 | 0,0030 | 0,84 | 0,1508 | 0,0043 | 0,84 | 0,1508 | 0,0068 | 1,21 | 0,1724 | 0,0055 | 1,21 | 0,1724 | 0,0086 |
| A02- | KN Vösendorf | KN Wien Inzersdorf | 0,75 | 0,1348 | 0,0024 | 0,75 | 0,1348 | 0,0037 | 1,05 | 0,1887 | 0,0054 | 1,06 | 0,1887 | 0,0085 | 1,51 | 0,2157 | 0,0068 | 1,52 | 0,2157 | 0,0108 |
| A02- | Mödling | KN Vösendorf | 0,51 | 0,0916 | 0,0016 | 0,51 | 0,0916 | 0,0025 | 0,72 | 0,1283 | 0,0037 | 0,72 | 0,1283 | 0,0058 | 1,03 | 0,1466 | 0,0047 | 1,03 | 0,1466 | 0,0073 |
| A02- | Wr. Neudorf | Mödling | 0,49 | 0,0874 | 0,0015 | 0,49 | 0,0874 | 0,0024 | 0,68 | 0,1224 | 0,0035 | 0,69 | 0,1224 | 0,0055 | 0,98 | 0,1399 | 0,0044 | 0,98 | 0,1399 | 0,0070 |
| A02- | Wr. Neudorf IZ/Süd | Wr. Neudorf | 0,54 | 0,0962 | 0,0017 | 0,54 | 0,0962 | 0,0026 | 0,75 | 0,1347 | 0,0039 | 0,75 | 0,1347 | 0,0061 | 1,08 | 0,1539 | 0,0049 | 1,08 | 0,1539 | 0,0077 |
| A02- | KN Guntramsdorf | Wr. Neudorf IZ/Süd | 0,78 | 0,1402 | 0,0025 | 0,78 | 0,1402 | 0,0039 | 1,10 | 0,1963 | 0,0056 | 1,10 | 0,1963 | 0,0089 | 1,57 | 0,2244 | 0,0071 | 1,58 | 0,2244 | 0,0112 |
| A02- | Traiskirchen | KN Guntramsdorf | 0,87 | 0,1562 | 0,0027 | 0,87 | 0,1562 | 0,0043 | 1,22 | 0,2186 | 0,0063 | 1,22 | 0,2186 | 0,0099 | 1,75 | 0,2499 | 0,0079 | 1,76 | 0,2499 | 0,0125 |
| A02- | Baden | Traiskirchen | 0,48 | 0,0869 | 0,0015 | 0,49 | 0,0869 | 0,0024 | 0,68 | 0,1217 | 0,0035 | 0,68 | 0,1217 | 0,0055 | 0,97 | 0,1391 | 0,0044 | 0,98 | 0,1391 | 0,0069 |
| A02- | Bad Vöslau | Baden | 0,80 | 0,1428 | 0,0025 | 0,80 | 0,1428 | 0,0039 | 1,12 | 0,1999 | 0,0057 | 1,12 | 0,1999 | 0,0090 | 1,60 | 0,2285 | 0,0072 | 1,61 | 0,2285 | 0,0114 |
| A02- | Kottingbrunn | Bad Vöslau | 0,57 | 0,1031 | 0,0018 | 0,58 | 0,1031 | 0,0028 | 0,81 | 0,1444 | 0,0042 | 0,81 | 0,1444 | 0,0065 | 1,16 | 0,1650 | 0,0052 | 1,16 | 0,1650 | 0,0082 |
| A02- | Leobersdorf | Kottingbrunn | 0,50 | 0,0905 | 0,0016 | 0,51 | 0,0905 | 0,0025 | 0,71 | 0,1267 | 0,0036 | 0,71 | 0,1267 | 0,0057 | 1,01 | 0,1448 | 0,0046 | 1,02 | 0,1448 | 0,0072 |
| A02- | Wöllersdorf | Leobersdorf | 2,01 | 0,3610 | 0,0063 | 2,02 | 0,3610 | 0,0099 | 2,82 | 0,5054 | 0,0145 | 2,83 | 0,5054 | 0,0228 | 4,05 | 0,5776 | 0,0183 | 4,06 | 0,5776 | 0,0288 |
| A02- | Wr. Neustadt West | Wöllersdorf | 1,31 | 0,2345 | 0,0041 | 1,31 | 0,2345 | 0,0064 | 1,83 | 0,3283 | 0,0094 | 1,84 | 0,3283 | 0,0148 | 2,63 | 0,3752 | 0,0119 | 2,64 | 0,3752 | 0,0187 |
| A02- | KN Wr. Neustadt | Wr. Neustadt West | 0,52 | 0,0939 | 0,0016 | 0,52 | 0,0939 | 0,0026 | 0,73 | 0,1314 | 0,0038 | 0,74 | 0,1314 | 0,0059 | 1,05 | 0,1502 | 0,0048 | 1,06 | 0,1502 | 0,0075 |
| A02- | KN Seebenstein | KN Wr. Neustadt | 2,37 | 0,4248 | 0,0074 | 2,37 | 0,4248 | 0,0117 | 3,32 | 0,5947 | 0,0171 | 3,33 | 0,5947 | 0,0269 | 4,76 | 0,6797 | 0,0216 | 4,78 | 0,6797 | 0,0339 |
| A02- | Grimmenstein | KN Seebenstein | 2,02 | 0,3624 | 0,0063 | 2,02 | 0,3624 | 0,0100 | 2,83 | 0,5073 | 0,0146 | 2,84 | 0,5073 | 0,0229 | 4,06 | 0,5798 | 0,0184 | 4,07 | 0,5798 | 0,0289 |
| A02- | Edlitz | Grimmenstein | 0,56 | 0,1003 | 0,0018 | 0,56 | 0,1003 | 0,0028 | 0,78 | 0,1404 | 0,0040 | 0,79 | 0,1404 | 0,0063 | 1,13 | 0,1605 | 0,0051 | 1,13 | 0,1605 | 0,0080 |
| A02- | Krumbach | Edlitz | 1,73 | 0,3098 | 0,0054 | 1,73 | 0,3098 | 0,0085 | 2,42 | 0,4337 | 0,0125 | 2,43 | 0,4337 | 0,0196 | 3,47 | 0,4957 | 0,0157 | 3,48 | 0,4957 | 0,0247 |
| A02- | Zöbern | Krumbach | 0,91 | 0,1635 | 0,0029 | 0,91 | 0,1635 | 0,0045 | 1,28 | 0,2289 | 0,0066 | 1,28 | 0,2289 | 0,0103 | 1,83 | 0,2616 | 0,0083 | 1,84 | 0,2616 | 0,0130 |
| A02- | Aspang | Zöbern | 0,12 | 0,0214 | 0,0004 | 0,12 | 0,0214 | 0,0006 | 0,17 | 0,0299 | 0,0009 | 0,17 | 0,0299 | 0,0014 | 0,24 | 0,0342 | 0,0011 | 0,24 | 0,0342 | 0,0017 |
| A02- | Schäffern | Aspang | 1,44 | 0,2588 | 0,0045 | 1,44 | 0,2588 | 0,0071 | 2,02 | 0,3623 | 0,0104 | 2,03 | 0,3623 | 0,0164 | 2,90 | 0,4140 | 0,0131 | 2,91 | 0,4140 | 0,0206 |
| A02- | Pinggau/Friedberg | Schäffern | 1,72 | 0,3091 | 0,0054 | 1,73 | 0,3091 | 0,0085 | 2,42 | 0,4327 | 0,0124 | 2,42 | 0,4327 | 0,0195 | 3,47 | 0,4945 | 0,0157 | 3,48 | 0,4945 | 0,0246 |
| A02- | Pinkafeld | Pinggau/Friedberg | 1,17 | 0,2094 | 0,0037 | 1,17 | 0,2094 | 0,0058 | 1,64 | 0,2931 | 0,0084 | 1,64 | 0,2931 | 0,0132 | 2,35 | 0,3350 | 0,0106 | 2,35 | 0,3350 | 0,0167 |
| A02- | Lafnitzal/Oberwart | Pinkafeld | 2,43 | 0,4364 | 0,0076 | 2,44 | 0,4364 | 0,0120 | 3,41 | 0,6110 | 0,0176 | 3,42 | 0,6110 | 0,0276 | 4,90 | 0,6983 | 0,0221 | 4,91 | 0,6983 | 0,0348 |
| A02- | Hartberg | Lafnitzal/Oberwart | 0,96 | 0,1723 | 0,0030 | 0,96 | 0,1723 | 0,0047 | 1,35 | 0,2412 | 0,0069 | 1,35 | 0,2412 | 0,0109 | 1,93 | 0,2756 | 0,0087 | 1,94 | 0,2756 | 0,0137 |
| A02- | Sebersdorf/Bad Waltersdorf | Hartberg | 2,43 | 0,4359 | 0,0076 | 2,43 | 0,4359 | 0,0120 | 3,41 | 0,6103 | 0,0175 | 3,42 | 0,6103 | 0,0276 | 4,89 | 0,6975 | 0,0221 | 4,90 | 0,6975 | 0,0348 |
| A02- | Ilz Fürstenfeld | Sebersdorf/Bad Waltersdorf | 2,72 | 0,4888 | 0,0086 | 2,73 | 0,4888 | 0,0134 | 3,82 | 0,6843 | 0,0197 | 3,83 | 0,6843 | 0,0309 | 5,48 | 0,7820 | 0,0248 | 5,50 | 0,7820 | 0,0390 |
| A02- | Sinabelkirchen | Ilz Fürstenfeld | 2,50 | 0,4493 | 0,0079 | 2,51 | 0,4493 | 0,0124 | 3,51 | 0,6290 | 0,0181 | 3,52 | 0,6290 | 0,0284 | 5,04 | 0,7189 | 0,0228 | 5,05 | 0,7189 | 0,0358 |
| A02- | Gleisdorf Süd | Sinabelkirchen | 1,65 | 0,2960 | 0,0052 | 1,65 | 0,2960 | 0,0081 | 2,31 | 0,4144 | 0,0119 | 2,32 | 0,4144 | 0,0187 | 3,32 | 0,4736 | 0,0150 | 3,33 | 0,4736 | 0,0236 |
| A02- | Gleisdorf West | Gleisdorf Süd | 0,72 | 0,1285 | 0,0022 | 0,72 | 0,1285 | 0,0035 | 1,00 | 0,1799 | 0,0052 | 1,01 | 0,1799 | 0,0081 | 1,44 | 0,2056 | 0,0065 | 1,44 | 0,2056 | 0,0102 |
| A02- | Laßnitzhöhe | Gleisdorf West | 1,88 | 0,3366 | 0,0059 | 1,88 | 0,3366 | 0,0093 | 2,63 | 0,4713 | 0,0135 | 2,64 | 0,4713 | 0,0213 | 3,78 | 0,5386 | 0,0171 | 3,79 | 0,5386 | 0,0268 |
| A02- | KN Graz Ost | Laßnitzhöhe | 2,35 | 0,4212 | 0,0074 | 2,35 | 0,4212 | 0,0116 | 3,29 | 0,5896 | 0,0170 | 3,30 | 0,5896 | 0,0266 | 4,72 | 0,6739 | 0,0214 | 4,74 | 0,6739 | 0,0336 |
| A02- | Graz Feldkirchen Flughafen | KN Graz Ost | 0,84 | 0,1515 | 0,0027 | 0,85 | 0,1515 | 0,0042 | 1,18 | 0,2121 | 0,0061 | 1,19 | 0,2121 | 0,0096 | 1,70 | 0,2424 | 0,0077 | 1,70 | 0,2424 | 0,0121 |
| A02- | KN Graz West | Graz Feldkirchen Flughafen | | | | | | | | | | | | | | | | | | |

| | | | | | | | | | | | | | | | | | | | | |
|------|----------------------------------|----------------------------------|------|--------|--------|------|----------|--------|------|--------|--------|------|--------|--------|------|--------|--------|------|--------|--------|
| A02- | Velden West | Velden Ost | 0,83 | 0,1493 | 0,0026 | 0,83 | 0,1493 | 0,0041 | 1,17 | 0,2090 | 0,0060 | 1,17 | 0,2090 | 0,0094 | 1,67 | 0,2389 | 0,0076 | 1,68 | 0,2389 | 0,0119 |
| A02- | Wernberg | Velden West | 1,38 | 0,2468 | 0,0043 | 1,38 | 0,2468 | 0,0068 | 1,93 | 0,3455 | 0,0099 | 1,93 | 0,3455 | 0,0156 | 2,77 | 0,3949 | 0,0125 | 2,78 | 0,3949 | 0,0197 |
| A02- | KN Villach | Wernberg | 0,73 | 0,1312 | 0,0023 | 0,73 | 0,1312 | 0,0036 | 1,03 | 0,1837 | 0,0053 | 1,03 | 0,1837 | 0,0083 | 1,47 | 0,2099 | 0,0067 | 1,48 | 0,2099 | 0,0105 |
| A02- | Villach Faaker See | KN Villach | 0,57 | 0,1020 | 0,0018 | 0,57 | 0,1020 | 0,0028 | 0,80 | 0,1428 | 0,0041 | 0,80 | 0,1428 | 0,0065 | 1,14 | 0,1632 | 0,0052 | 1,15 | 0,1632 | 0,0081 |
| A02- | Villach Warmbad | Villach Faaker See | 1,30 | 0,2330 | 0,0041 | 1,30 | 0,2330 | 0,0064 | 1,82 | 0,3262 | 0,0094 | 1,83 | 0,3262 | 0,0147 | 2,61 | 0,3728 | 0,0118 | 2,62 | 0,3728 | 0,0186 |
| A02- | Hermagor | Villach Warmbad | 2,35 | 0,4224 | 0,0074 | 2,36 | 0,4224 | 0,0116 | 3,30 | 0,5914 | 0,0170 | 3,31 | 0,5914 | 0,0267 | 4,74 | 0,6758 | 0,0214 | 4,75 | 0,6758 | 0,0337 |
| A02- | Arnoldstein | Hermagor | 0,56 | 0,1006 | 0,0018 | 0,56 | 0,1006 | 0,0028 | 0,79 | 0,1408 | 0,0040 | 0,79 | 0,1408 | 0,0064 | 1,13 | 0,1610 | 0,0051 | 1,13 | 0,1610 | 0,0080 |
| A02- | Staatsgrenze Arnoldstein | Arnoldstein | 0,86 | 0,1542 | 0,0027 | 0,86 | 0,1542 | 0,0042 | 1,21 | 0,2159 | 0,0062 | 1,21 | 0,2159 | 0,0098 | 1,73 | 0,2468 | 0,0078 | 1,73 | 0,2468 | 0,0123 |
| A03- | Münchendorf/Achau | KN Guntramsdorf | 0,22 | 0,0400 | 0,0007 | 0,22 | 0,0400 | 0,0011 | 0,31 | 0,0561 | 0,0016 | 0,31 | 0,0561 | 0,0025 | 0,45 | 0,0641 | 0,0020 | 0,45 | 0,0641 | 0,0032 |
| A03- | Ebreichsdorf Nord | Münchendorf/Achau | 0,94 | 0,1686 | 0,0029 | 0,94 | 0,1686 | 0,0046 | 1,32 | 0,2360 | 0,0068 | 1,32 | 0,2360 | 0,0107 | 1,89 | 0,2697 | 0,0086 | 1,90 | 0,2697 | 0,0134 |
| A03- | Ebreichsdorf West | Ebreichsdorf Nord | 0,77 | 0,1376 | 0,0024 | 0,77 | 0,1376 | 0,0038 | 1,08 | 0,1926 | 0,0055 | 1,08 | 0,1926 | 0,0087 | 1,54 | 0,2202 | 0,0070 | 1,55 | 0,2202 | 0,0110 |
| A03- | Pottendorf | Ebreichsdorf West | 1,01 | 0,1805 | 0,0032 | 1,01 | 0,1805 | 0,0050 | 1,41 | 0,2527 | 0,0073 | 1,42 | 0,2527 | 0,0114 | 2,02 | 0,2888 | 0,0092 | 2,03 | 0,2888 | 0,0144 |
| A03- | Hornstein | Pottendorf | 1,65 | 0,2964 | 0,0052 | 1,65 | 0,2964 | 0,0082 | 2,32 | 0,4150 | 0,0119 | 2,32 | 0,4150 | 0,0187 | 3,32 | 0,4742 | 0,0150 | 3,33 | 0,4742 | 0,0236 |
| A03- | Müllendorf | Hornstein | 1,08 | 0,1942 | 0,0034 | 1,08 | 0,1942 | 0,0053 | 1,52 | 0,2719 | 0,0078 | 1,52 | 0,2719 | 0,0123 | 2,18 | 0,3108 | 0,0099 | 2,18 | 0,3108 | 0,0155 |
| A03- | KN Eisenstadt | Müllendorf | 0,90 | 0,1624 | 0,0028 | 0,91 | 0,1624 | 0,0045 | 1,27 | 0,2273 | 0,0065 | 1,27 | 0,2273 | 0,0103 | 1,82 | 0,2598 | 0,0082 | 1,83 | 0,2598 | 0,0129 |
| A031 | Siegendorf | KN Eisenstadt | 0,71 | 0,1280 | 0,0022 | 0,71 | 0,1280 | 0,0035 | 1,00 | 0,1792 | 0,0052 | 1,00 | 0,1792 | 0,0081 | 1,44 | 0,2048 | 0,0065 | 1,44 | 0,2048 | 0,0102 |
| A041 | KN Wien Prater | Stadionbrücke | 0,13 | 0,0235 | 0,0004 | 0,13 | 0,0235 | 0,0006 | 0,18 | 0,0329 | 0,0009 | 0,18 | 0,0329 | 0,0015 | 0,26 | 0,0376 | 0,0012 | 0,26 | 0,0376 | 0,0019 |
| A04- | Wien Simmeringer Haide | KN Wien Prater | 0,90 | 0,1622 | 0,0028 | 0,91 | 0,1622 | 0,0045 | 1,27 | 0,2271 | 0,0065 | 1,27 | 0,2271 | 0,0103 | 1,82 | 0,2595 | 0,0082 | 1,82 | 0,2595 | 0,0129 |
| A04- | KN Schwechat | Wien Simmeringer Haide | 0,81 | 0,1456 | 0,0025 | 0,81 | 0,1456 | 0,0040 | 1,14 | 0,2038 | 0,0059 | 1,14 | 0,2038 | 0,0092 | 1,63 | 0,2330 | 0,0074 | 1,64 | 0,2330 | 0,0116 |
| A04- | Flughafen Wien Schwechat | KN Schwechat | 1,17 | 0,2103 | 0,0037 | 1,17 | 0,2103 | 0,0058 | 1,64 | 0,2944 | 0,0085 | 1,65 | 0,2944 | 0,0133 | 2,36 | 0,3365 | 0,0107 | 2,37 | 0,3365 | 0,0168 |
| A04- | Fischamend | Flughafen Wien Schwechat | 1,31 | 0,2355 | 0,0041 | 1,31 | 0,2355 | 0,0065 | 1,84 | 0,3297 | 0,0095 | 1,85 | 0,3297 | 0,0149 | 2,64 | 0,3768 | 0,0120 | 2,65 | 0,3768 | 0,0188 |
| A04- | Bruck/Leitha West | Fischamend | 2,88 | 0,5164 | 0,0090 | 2,88 | 0,5164 | 0,0142 | 4,04 | 0,7230 | 0,0208 | 4,05 | 0,7230 | 0,0327 | 5,79 | 0,8263 | 0,0262 | 5,81 | 0,8263 | 0,0412 |
| A04- | Bruck/Leitha Ost | Bruck/Leitha West | 0,96 | 0,1715 | 0,0030 | 0,96 | 0,1715 | 0,0047 | 1,34 | 0,2401 | 0,0069 | 1,34 | 0,2401 | 0,0108 | 1,92 | 0,2744 | 0,0087 | 1,93 | 0,2744 | 0,0137 |
| A04- | KN Bruckneudorf | Bruck/Leitha Ost | 0,60 | 0,1070 | 0,0019 | 0,60 | 0,1070 | 0,0029 | 0,84 | 0,1498 | 0,0043 | 0,84 | 0,1498 | 0,0068 | 1,20 | 0,1712 | 0,0054 | 1,20 | 0,1712 | 0,0085 |
| A04- | Parndorf | KN Bruckneudorf | 0,38 | 0,0689 | 0,0012 | 0,38 | 0,0689 | 0,0019 | 0,54 | 0,0964 | 0,0028 | 0,54 | 0,0964 | 0,0044 | 0,77 | 0,1102 | 0,0035 | 0,77 | 0,1102 | 0,0055 |
| A04- | Neusiedl | Parndorf | 0,74 | 0,1332 | 0,0023 | 0,74 | 0,1332 | 0,0037 | 1,04 | 0,1865 | 0,0054 | 1,04 | 0,1865 | 0,0084 | 1,49 | 0,2131 | 0,0068 | 1,50 | 0,2131 | 0,0106 |
| A04- | Neusiedl/Gewerbepark | Neusiedl | 0,17 | 0,0309 | 0,0005 | 0,17 | 0,0309 | 0,0008 | 0,24 | 0,0432 | 0,0012 | 0,24 | 0,0432 | 0,0020 | 0,35 | 0,0494 | 0,0016 | 0,35 | 0,0494 | 0,0025 |
| A04- | Weiden/Gols | Neusiedl/Gewerbepark | 1,54 | 0,2762 | 0,0048 | 1,54 | 0,2762 | 0,0076 | 2,16 | 0,3867 | 0,0111 | 2,17 | 0,3867 | 0,0175 | 3,10 | 0,4420 | 0,0140 | 3,11 | 0,4420 | 0,0220 |
| A04- | Mönchhof | Weiden/Gols | 1,12 | 0,2015 | 0,0035 | 1,12 | 0,2015 | 0,0055 | 1,58 | 0,2821 | 0,0081 | 1,58 | 0,2821 | 0,0127 | 2,26 | 0,3224 | 0,0102 | 2,27 | 0,3224 | 0,0161 |
| A04- | Nickelsdorf | Mönchhof | 1,76 | 0,3157 | 0,0055 | 1,76 | 0,3157 | 0,0087 | 2,47 | 0,4420 | 0,0127 | 2,48 | 0,4420 | 0,0200 | 3,54 | 0,5052 | 0,0160 | 3,55 | 0,5052 | 0,0252 |
| A04- | Staatsgrenze Nickelsdorf | Nickelsdorf | 0,31 | 0,0559 | 0,0010 | 0,31 | 0,0559 | 0,0015 | 0,44 | 0,0783 | 0,0023 | 0,44 | 0,0783 | 0,0035 | 0,63 | 0,0895 | 0,0028 | 0,63 | 0,0895 | 0,0045 |
| A05- | Wolkersdorf Süd | KN Eibesbrunn | 0,61 | 0,1088 | 0,0019 | 0,61 | 0,1088 | 0,0030 | 0,85 | 0,1524 | 0,0044 | 0,85 | 0,1524 | 0,0069 | 1,22 | 0,1741 | 0,0055 | 1,22 | 0,1741 | 0,0087 |
| A05- | Ulrichskirchen | Wolkersdorf Süd | 0,66 | 0,1177 | 0,0021 | 0,66 | 0,1177 | 0,0032 | 0,92 | 0,1648 | 0,0047 | 0,92 | 0,1648 | 0,0074 | 1,32 | 0,1884 | 0,0060 | 1,32 | 0,1884 | 0,0094 |
| A05- | Wolkersdorf Nord | Ulrichskirchen | 0,43 | 0,0769 | 0,0013 | 0,43 | 0,0769 | 0,0021 | 0,60 | 0,1077 | 0,0031 | 0,60 | 0,1077 | 0,0049 | 0,86 | 0,1231 | 0,0039 | 0,87 | 0,1231 | 0,0061 |
| A05- | Hochleithen | Wolkersdorf Nord | 0,77 | 0,1380 | 0,0024 | 0,77 | 0,1380 | 0,0038 | 1,08 | 0,1932 | 0,0056 | 1,08 | 0,1932 | 0,0087 | 1,55 | 0,2208 | 0,0070 | 1,55 | 0,2208 | 0,0110 |
| A05- | Gaweinstal Mitte | Hochleithen | 1,54 | 0,2761 | 0,0048 | 1,54 | 0,2761 | 0,0076 | 2,16 | 0,3865 | 0,0111 | 2,16 | 0,3865 | 0,0175 | 3,10 | 0,4417 | 0,0140 | 3,10 | 0,4417 | 0,0220 |
| A05- | Gaweinstal Nord | Gaweinstal Mitte | 0,41 | 0,0730 | 0,0013 | 0,41 | 0,0730 | 0,0020 | 0,57 | 0,1023 | 0,0029 | 0,57 | 0,1023 | 0,0046 | 0,82 | 0,1169 | 0,0037 | 0,82 | 0,1169 | 0,0058 |
| A05- | Mistelbach Süd | Gaweinstal Nord | 0,70 | 0,1261 | 0,0022 | 0,70 | 0,1261 | 0,0035 | 0,99 | 0,1765 | 0,0051 | 0,99 | 0,1765 | 0,0080 | 1,41 | 0,2017 | 0,0064 | 1,42 | 0,2017 | 0,0101 |
| A05- | Mistelbach Ost / Wilfersdorf | Mistelbach Süd | 1,18 | 0,2116 | 0,0037 | 1,18 | 0,2116 | 0,0058 | 1,65 | 0,2962 | 0,0085 | 1,66 | 0,2962 | 0,0134 | 2,37 | 0,3386 | 0,0107 | 2,38 | 0,3386 | 0,0169 |
| A05- | Poysdorf Süd | Mistelbach Ost / Wilfersdorf | 1,19 | 0,2137 | 0,0037 | 1,19 | 0,2137 | 0,0059 | 1,67 | 0,2992 | 0,0086 | 1,68 | 0,2992 | 0,0135 | 2,40 | 0,3419 | 0,0108 | 2,40 | 0,3419 | 0,0170 |
| A05- | Großkrut | Poysdorf Süd | 1,57 | 0,2818 | 0,0049 | 1,57 | 0,2818 | 0,0077 | 2,20 | 0,3945 | 0,0113 | 2,21 | 0,3945 | 0,0178 | 3,16 | 0,4509 | 0,0143 | 3,17 | 0,4509 | 0,0225 |
| A05- | Poysdorf Nord | Großkrut | 1,53 | 0,2741 | 0,0048 | 1,53 | 0,2741 | 0,0075 | 2,14 | 0,3838 | 0,0110 | 2,15 | 0,3838 | 0,0173 | 3,07 | 0,4386 | 0,0139 | 3,08 | 0,4386 | 0,0219 |
| A06- | Potzneusiedl | KN Bruckneudorf | 1,94 | 0,3472 | 0,0061 | 1,94 | 0,3472 | 0,0095 | 2,71 | 0,4861 | 0,0140 | 2,72 | 0,4861 | 0,0220 | 3,89 | 0,5556 | 0,0176 | 3,90 | 0,5556 | 0,0277 |
| A06- | Gattendorf | Potzneusiedl | 0,84 | 0,1507 | 0,0026 | 0,84 | 0,1507 | 0,0041 | 1,18 | 0,2110 | 0,0061 | 1,18 | 0,2110 | 0,0095 | 1,69 | 0,2412 | 0,0076 | 1,69 | 0,2412 | 0,0120 |
| A06- | Kittsee | Gattendorf | 1,40 | 0,2521 | 0,0044 | 1,41 | 0,2521 | 0,0069 | 1,97 | 0,3529 | 0,0101 | 1,98 | 0,3529 | 0,0159 | 2,83 | 0,4033 | 0,0128 | 2,83 | 0,4033 | 0,0201 |
| A06- | Staatsgrenze Kittsee | Kittsee | 0,71 | 0,1280 | 0,0022 | 0,71 | 0,1280 | 0,0035 | 1,00 | 0,1793 | 0,0052 | 1,00 | 0,1793 | 0,0081 | 1,44 | 0,2049 | 0,0065 | 1,44 | 0,2049 | 0,0102 |
| A07- | Linz Franzosenhausweg | KN Linz | 0,50 | 0,0903 | 0,0016 | 0,50 | 0,0903 | 0,0025 | 0,71 | 0,1264 | 0,0036 | 0,71 | 0,1264 | 0,0057 | 1,01 | 0,1445 | 0,0046 | 1,02 | 0,1445 | 0,0072 |
| A07- | Linz Salzburger Straße Neue Welt | Linz Franzosenhausweg | 0,44 | 0,0788 | 0,0014 | 0,44 | 0,0788 | 0,0022 | 0,62 | 0,1104 | 0,0032 | 0,62 | 0,1104 | 0,0050 | 0,88 | 0,1261 | 0,0040 | 0,89 | 0,1261 | 0,0063 |
| A07- | Muldenstraße Bindermichl | Linz Salzburger Straße Neue Welt | 0,30 | 0,0547 | 0,0010 | 0,31 | 0,0547 | 0,0015 | 0,43 | 0,0766 | 0,0022 | 0,43 | 0,0766 | 0,0035 | 0,61 | 0,0876 | 0,0028 | 0,62 | 0,0876 | 0,0044 |
| A07- | Leonding Linz Zentrum | Muldenstraße Bindermichl | 0,15 | 0,0266 | 0,0005 | 0,15 | 0,0266 | 0,0007 | 0,21 | 0,0372 | 0,0011 | 0,21 | 0,0372 | 0,0017 | 0,30 | 0,0425 | 0,0013 | 0,30 | 0,0425 | 0,0021 |
| A07- | Linz Wiener Straße | Leonding Linz Zentrum | 0,21 | 0,0374 | 0,0007 | 0,21 | 0,0374 | 0,0010 | 0,29 | 0,0523 | 0,0015 | 0,29 | 0,0523 | 0,0024 | 0,42 | 0,0598 | 0,0019 | 0,42 | 0,0598 | 0,0030 |
| A07- | Linz VOEST | Linz Wiener Straße | 0,19 | 0,0347 | 0,0006 | 0,19 | 0,0347 | 0,0010 | 0,27 | 0,0486 | 0,0014 | 0,27 | 0,0486 | 0,0022 | 0,39 | 0,0556 | 0,0018 | 0,39 | 0,0556 | 0,0028 |
| A07- | Linz Industriezeile | Linz VOEST | 0,15 | 0,0272 | 0,0005 | 0,15 | 0,0272 | 0,0007 | 0,21 | 0,0381 | 0,0011 | 0,21 | 0,0381 | 0,0017 | 0,31 | 0,0436 | 0,0014 | 0,31 | 0,0436 | 0,0022 |
| A07- | Linz Prinz Eugenstraße | Linz Industriezeile | 0,24 | 0,0432 | 0,0008 | 0,24 | 0,0432 | 0,0012 | 0,34 | 0,0605 | 0,0017 | 0,34 | 0,0605 | 0,0027 | 0,49 | 0,0692 | 0,0022 | 0,49 | 0,0692 | 0,0034 |
| A07- | Linz Hafensstraße | Linz Prinz Eugenstraße | 0,45 | 0,0809 | 0,0014 | 0,45 | 0,0809 | 0,0022 | 0,63 | 0,1133 | 0,0033 | 0,63 | 0,1133 | 0,0051 | 0,91 | 0,1295 | 0,0041 | 0,91 | 0,1295 | 0,0065 |
| A07- | Linz Urfahr | Linz Hafensstraße | 0,18 | 0,0318 | 0,0006 | 0,18 | 0,0318 | 0,0009 | 0,25 | 0,0445 | 0,0013 | 0,25 | 0,0445 | 0,0020 | 0,36 | 0,0509 | 0,0016 | 0,36 | 0,0509 | 0,0025 |
| A07- | Linz Dornach | Linz Urfahr | 0,43 | 0,0770 | 0,0013 | 0,43 | 0,0770</ | | | | | | | | | | | | | |

| | | | | | | | | | | | | | | | | | | | | |
|------|---|--------------------------------------|-------|--------|--------|-------|--------|--------|-------|--------|--------|-------|--------|--------|-------|--------|--------|-------|--------|--------|
| A08- | Staatsgrenze Suben | Schärding Suben | 0,50 | 0,0893 | 0,0016 | 0,50 | 0,0893 | 0,0025 | 0,70 | 0,1250 | 0,0036 | 0,70 | 0,1250 | 0,0056 | 1,00 | 0,1428 | 0,0045 | 1,00 | 0,1428 | 0,0071 |
| A09- | Ried im Traunkreis | KN Voralpenkreuz | 1,23 | 0,2200 | 0,0039 | 1,23 | 0,2200 | 0,0061 | 1,72 | 0,3081 | 0,0089 | 1,73 | 0,3081 | 0,0139 | 2,47 | 0,3521 | 0,0112 | 2,47 | 0,3521 | 0,0175 |
| A09- | Inzersdorf Kirchdorf | Ried im Traunkreis | 2,30 | 0,4128 | 0,0072 | 2,30 | 0,4128 | 0,0114 | 3,23 | 0,5779 | 0,0166 | 3,24 | 0,5779 | 0,0261 | 4,63 | 0,6604 | 0,0209 | 4,64 | 0,6604 | 0,0329 |
| A09- | Klaus | Inzersdorf Kirchdorf | 2,80 | 0,5028 | 0,0088 | 2,81 | 0,5028 | 0,0138 | 3,93 | 0,7039 | 0,0202 | 3,94 | 0,7039 | 0,0318 | 5,64 | 0,8045 | 0,0255 | 5,65 | 0,8045 | 0,0401 |
| A09- | St. Pankratz | Klaus | 1,78 | 0,3196 | 0,0056 | 1,78 | 0,3196 | 0,0088 | 2,50 | 0,4474 | 0,0129 | 2,51 | 0,4474 | 0,0202 | 3,58 | 0,5114 | 0,0162 | 3,59 | 0,5114 | 0,0255 |
| A09- | Roßleiten Windischgarsten | St. Pankratz | 2,48 | 0,4459 | 0,0078 | 2,49 | 0,4459 | 0,0123 | 3,49 | 0,6243 | 0,0179 | 3,50 | 0,6243 | 0,0282 | 5,00 | 0,7135 | 0,0226 | 5,01 | 0,7135 | 0,0356 |
| A09- | Gleinkerau | Roßleiten Windischgarsten | 1,17 | 0,2096 | 0,0037 | 1,17 | 0,2096 | 0,0058 | 1,64 | 0,2934 | 0,0084 | 1,64 | 0,2934 | 0,0133 | 2,35 | 0,3354 | 0,0106 | 2,36 | 0,3354 | 0,0167 |
| A09- | Spital am Pyhrn | Gleinkerau | 0,88 | 0,1580 | 0,0028 | 0,88 | 0,1580 | 0,0043 | 1,24 | 0,2212 | 0,0064 | 1,24 | 0,2212 | 0,0100 | 1,77 | 0,2528 | 0,0080 | 1,78 | 0,2528 | 0,0126 |
| A09- | Ardning / Admont | Spital am Pyhrn | 4,53 | 0,4022 | 0,0070 | 4,54 | 0,4022 | 0,0111 | 6,35 | 0,5631 | 0,0162 | 6,36 | 0,5631 | 0,0254 | 9,33 | 0,6436 | 0,0204 | 9,34 | 0,6436 | 0,0321 |
| A09- | Liezen | Ardning / Admont | 0,51 | 0,0917 | 0,0016 | 0,51 | 0,0917 | 0,0025 | 0,72 | 0,1284 | 0,0037 | 0,72 | 0,1284 | 0,0058 | 1,03 | 0,1467 | 0,0047 | 1,03 | 0,1467 | 0,0073 |
| A09- | Rottenmann | Liezen | 1,07 | 0,1916 | 0,0034 | 1,07 | 0,1916 | 0,0053 | 1,50 | 0,2682 | 0,0077 | 1,50 | 0,2682 | 0,0121 | 2,15 | 0,3065 | 0,0097 | 2,15 | 0,3065 | 0,0153 |
| A09- | Trieben | Rottenmann | 2,66 | 0,4776 | 0,0084 | 2,67 | 0,4776 | 0,0131 | 3,73 | 0,6686 | 0,0192 | 3,74 | 0,6686 | 0,0302 | 5,36 | 0,7641 | 0,0242 | 5,37 | 0,7641 | 0,0381 |
| A09- | Treglwang | Trieben | 2,16 | 0,3883 | 0,0068 | 2,17 | 0,3883 | 0,0107 | 3,04 | 0,5436 | 0,0156 | 3,04 | 0,5436 | 0,0246 | 4,36 | 0,6212 | 0,0197 | 4,37 | 0,6212 | 0,0310 |
| A09- | Kalwang | Treglwang | 2,91 | 0,5218 | 0,0091 | 2,91 | 0,5218 | 0,0143 | 4,08 | 0,7305 | 0,0210 | 4,09 | 0,7305 | 0,0330 | 5,85 | 0,8349 | 0,0265 | 5,87 | 0,8349 | 0,0416 |
| A09- | Mautern | Kalwang | 1,35 | 0,2430 | 0,0043 | 1,36 | 0,2430 | 0,0067 | 1,90 | 0,3401 | 0,0098 | 1,90 | 0,3401 | 0,0154 | 2,73 | 0,3887 | 0,0123 | 2,73 | 0,3887 | 0,0194 |
| A09- | Kammern | Mautern | 1,52 | 0,2733 | 0,0048 | 1,53 | 0,2733 | 0,0075 | 2,14 | 0,3826 | 0,0110 | 2,14 | 0,3826 | 0,0173 | 3,07 | 0,4373 | 0,0139 | 3,07 | 0,4373 | 0,0218 |
| A09- | Traboch | Kammern | 1,59 | 0,2858 | 0,0050 | 1,60 | 0,2858 | 0,0079 | 2,23 | 0,4001 | 0,0115 | 2,24 | 0,4001 | 0,0181 | 3,21 | 0,4572 | 0,0145 | 3,21 | 0,4572 | 0,0228 |
| A09- | Terminal St. Michael | Traboch | 0,31 | 0,0561 | 0,0010 | 0,31 | 0,0561 | 0,0015 | 0,44 | 0,0786 | 0,0023 | 0,44 | 0,0786 | 0,0035 | 0,63 | 0,0898 | 0,0028 | 0,63 | 0,0898 | 0,0045 |
| A09- | KN St. Michael | Terminal St. Michael | 0,59 | 0,1052 | 0,0018 | 0,59 | 0,1052 | 0,0029 | 0,82 | 0,1473 | 0,0042 | 0,82 | 0,1473 | 0,0067 | 1,18 | 0,1683 | 0,0053 | 1,18 | 0,1683 | 0,0084 |
| A09- | Übelbach | KN St. Michael | 11,04 | 0,9797 | 0,0171 | 11,05 | 0,9797 | 0,0269 | 15,48 | 1,3716 | 0,0394 | 15,50 | 1,3716 | 0,0620 | 22,72 | 1,5676 | 0,0497 | 22,74 | 1,5676 | 0,0781 |
| A09- | KN Peggau Deutschefstritz | Übelbach | 1,81 | 0,3240 | 0,0057 | 1,81 | 0,3240 | 0,0089 | 2,53 | 0,4537 | 0,0130 | 2,54 | 0,4537 | 0,0205 | 3,63 | 0,5185 | 0,0164 | 3,64 | 0,5185 | 0,0258 |
| A09- | Gratkorn Nord | KN Peggau Deutschefstritz | 0,86 | 0,1535 | 0,0027 | 0,86 | 0,1535 | 0,0042 | 1,20 | 0,2149 | 0,0062 | 1,20 | 0,2149 | 0,0097 | 1,72 | 0,2456 | 0,0078 | 1,73 | 0,2456 | 0,0122 |
| A09- | Gratkorn Süd | Gratkorn Nord | 0,94 | 0,1686 | 0,0030 | 0,94 | 0,1686 | 0,0046 | 1,32 | 0,2360 | 0,0068 | 1,32 | 0,2360 | 0,0107 | 1,89 | 0,2698 | 0,0086 | 1,90 | 0,2698 | 0,0134 |
| A09- | Graz Nord | Gratkorn Süd | 0,21 | 0,0374 | 0,0007 | 0,21 | 0,0374 | 0,0010 | 0,29 | 0,0523 | 0,0015 | 0,29 | 0,0523 | 0,0024 | 0,42 | 0,0598 | 0,0019 | 0,42 | 0,0598 | 0,0030 |
| A09- | Graz Webling | Graz Nord | 2,38 | 0,4274 | 0,0075 | 2,39 | 0,4274 | 0,0118 | 3,34 | 0,5983 | 0,0172 | 3,35 | 0,5983 | 0,0270 | 4,79 | 0,6838 | 0,0217 | 4,81 | 0,6838 | 0,0341 |
| A09- | Seiersberg | Graz Webling | 0,63 | 0,1136 | 0,0020 | 0,63 | 0,1136 | 0,0031 | 0,89 | 0,1590 | 0,0046 | 0,89 | 0,1590 | 0,0072 | 1,27 | 0,1818 | 0,0058 | 1,28 | 0,1818 | 0,0091 |
| A09- | KN Graz West | Seiersberg | 0,31 | 0,0556 | 0,0010 | 0,31 | 0,0556 | 0,0015 | 0,43 | 0,0778 | 0,0022 | 0,44 | 0,0778 | 0,0035 | 0,62 | 0,0890 | 0,0028 | 0,63 | 0,0890 | 0,0044 |
| A09- | Schwarzlsee | KN Graz West | 0,31 | 0,0548 | 0,0010 | 0,31 | 0,0548 | 0,0015 | 0,43 | 0,0767 | 0,0022 | 0,43 | 0,0767 | 0,0035 | 0,61 | 0,0877 | 0,0028 | 0,62 | 0,0877 | 0,0044 |
| A09- | Schachenwald / IBC Businesscenter | Schwarzlsee | 0,34 | 0,0613 | 0,0011 | 0,34 | 0,0613 | 0,0017 | 0,48 | 0,0858 | 0,0025 | 0,48 | 0,0858 | 0,0039 | 0,69 | 0,0980 | 0,0031 | 0,69 | 0,0980 | 0,0049 |
| A09- | Kalsdorf | Schachenwald / IBC Businesscenter | 0,35 | 0,0623 | 0,0011 | 0,35 | 0,0623 | 0,0017 | 0,49 | 0,0872 | 0,0025 | 0,49 | 0,0872 | 0,0039 | 0,70 | 0,0997 | 0,0032 | 0,70 | 0,0997 | 0,0050 |
| A09- | Werndorf Terminal | Kalsdorf | 0,87 | 0,1560 | 0,0027 | 0,87 | 0,1560 | 0,0043 | 1,22 | 0,2184 | 0,0063 | 1,22 | 0,2184 | 0,0099 | 1,75 | 0,2496 | 0,0079 | 1,75 | 0,2496 | 0,0124 |
| A09- | Wildon | Werndorf Terminal | 0,97 | 0,1744 | 0,0031 | 0,97 | 0,1744 | 0,0048 | 1,36 | 0,2441 | 0,0070 | 1,37 | 0,2441 | 0,0110 | 1,96 | 0,2790 | 0,0088 | 1,96 | 0,2790 | 0,0139 |
| A09- | Hengsberg | Wildon | 0,47 | 0,0851 | 0,0015 | 0,48 | 0,0851 | 0,0023 | 0,67 | 0,1192 | 0,0034 | 0,67 | 0,1192 | 0,0054 | 0,95 | 0,1362 | 0,0043 | 0,96 | 0,1362 | 0,0068 |
| A09- | Lebring | Hengsberg | 0,84 | 0,1508 | 0,0026 | 0,84 | 0,1508 | 0,0041 | 1,18 | 0,2111 | 0,0061 | 1,18 | 0,2111 | 0,0095 | 1,69 | 0,2413 | 0,0077 | 1,70 | 0,2413 | 0,0120 |
| A09- | Leibnitz | Lebring | 1,45 | 0,2610 | 0,0046 | 1,46 | 0,2610 | 0,0072 | 2,04 | 0,3655 | 0,0105 | 2,05 | 0,3655 | 0,0165 | 2,93 | 0,4177 | 0,0132 | 2,94 | 0,4177 | 0,0208 |
| A09- | Vogau Straß | Leibnitz | 1,78 | 0,3192 | 0,0056 | 1,78 | 0,3192 | 0,0088 | 2,50 | 0,4469 | 0,0128 | 2,50 | 0,4469 | 0,0202 | 3,58 | 0,5108 | 0,0162 | 3,59 | 0,5108 | 0,0255 |
| A09- | Gersdorf | Vogau Straß | 0,86 | 0,1548 | 0,0027 | 0,86 | 0,1548 | 0,0043 | 1,21 | 0,2168 | 0,0062 | 1,21 | 0,2168 | 0,0098 | 1,74 | 0,2477 | 0,0079 | 1,74 | 0,2477 | 0,0123 |
| A09- | Spielfeld | Gersdorf | 0,45 | 0,0816 | 0,0014 | 0,46 | 0,0816 | 0,0022 | 0,64 | 0,1142 | 0,0033 | 0,64 | 0,1142 | 0,0052 | 0,92 | 0,1306 | 0,0041 | 0,92 | 0,1306 | 0,0065 |
| A09- | Staatsgrenze Spielfeld | Spielfeld | 0,41 | 0,0744 | 0,0013 | 0,42 | 0,0744 | 0,0020 | 0,58 | 0,1042 | 0,0030 | 0,58 | 0,1042 | 0,0047 | 0,83 | 0,1190 | 0,0038 | 0,84 | 0,1190 | 0,0059 |
| A10- | Salzburg Süd / Anif | KN Salzburg | 1,68 | 0,3010 | 0,0053 | 1,68 | 0,3010 | 0,0083 | 2,35 | 0,4213 | 0,0121 | 2,36 | 0,4213 | 0,0190 | 3,38 | 0,4815 | 0,0153 | 3,38 | 0,4815 | 0,0240 |
| A10- | Puch Urstein | Salzburg Süd / Anif | 0,57 | 0,1021 | 0,0018 | 0,57 | 0,1021 | 0,0028 | 0,80 | 0,1430 | 0,0041 | 0,80 | 0,1430 | 0,0065 | 1,15 | 0,1634 | 0,0052 | 1,15 | 0,1634 | 0,0081 |
| A10- | Hallein | Puch Urstein | 1,17 | 0,2108 | 0,0037 | 1,18 | 0,2108 | 0,0058 | 1,65 | 0,2952 | 0,0085 | 1,65 | 0,2952 | 0,0133 | 2,36 | 0,3373 | 0,0107 | 2,37 | 0,3373 | 0,0168 |
| A10- | Kuchl | Hallein | 1,30 | 0,2342 | 0,0041 | 1,31 | 0,2342 | 0,0064 | 1,83 | 0,3278 | 0,0094 | 1,84 | 0,3278 | 0,0148 | 2,63 | 0,3747 | 0,0119 | 2,63 | 0,3747 | 0,0187 |
| A10- | Golling / Abtenau | Kuchl | 1,31 | 0,2354 | 0,0041 | 1,31 | 0,2354 | 0,0065 | 1,84 | 0,3296 | 0,0095 | 1,85 | 0,3296 | 0,0149 | 2,64 | 0,3766 | 0,0119 | 2,65 | 0,3766 | 0,0188 |
| A10- | Paß Lueg | Golling / Abtenau | 1,37 | 0,2456 | 0,0043 | 1,37 | 0,2456 | 0,0068 | 1,92 | 0,3439 | 0,0099 | 1,93 | 0,3439 | 0,0155 | 2,76 | 0,3930 | 0,0125 | 2,76 | 0,3930 | 0,0196 |
| A10- | Werfen | Paß Lueg | 1,95 | 0,3499 | 0,0061 | 1,95 | 0,3499 | 0,0096 | 2,74 | 0,4898 | 0,0141 | 2,74 | 0,4898 | 0,0221 | 3,92 | 0,5598 | 0,0178 | 3,93 | 0,5598 | 0,0279 |
| A10- | Pfarrwerfen / Werfen | Werfen | 0,25 | 0,0456 | 0,0008 | 0,25 | 0,0456 | 0,0013 | 0,36 | 0,0638 | 0,0018 | 0,36 | 0,0638 | 0,0029 | 0,51 | 0,0730 | 0,0023 | 0,51 | 0,0730 | 0,0036 |
| A10- | KN Pongau | Pfarrwerfen / Werfen | 0,55 | 0,0990 | 0,0017 | 0,55 | 0,0990 | 0,0027 | 0,77 | 0,1385 | 0,0040 | 0,78 | 0,1385 | 0,0063 | 1,11 | 0,1583 | 0,0050 | 1,11 | 0,1583 | 0,0079 |
| A101 | Bischofshofen Mühlbach a. Hochkönig | KN Pongau | 0,82 | 0,1472 | 0,0026 | 0,82 | 0,1472 | 0,0040 | 1,15 | 0,2061 | 0,0059 | 1,15 | 0,2061 | 0,0093 | 1,65 | 0,2355 | 0,0075 | 1,66 | 0,2355 | 0,0117 |
| A10- | Lammertal Hüttal | KN Pongau | 2,24 | 0,4025 | 0,0070 | 2,25 | 0,4025 | 0,0111 | 3,15 | 0,5635 | 0,0162 | 3,16 | 0,5635 | 0,0255 | 4,51 | 0,6440 | 0,0204 | 4,53 | 0,6440 | 0,0321 |
| A10- | F. Verbindung GH Eben | Lammertal Hüttal | 0,58 | 0,1036 | 0,0018 | 0,58 | 0,1036 | 0,0028 | 0,81 | 0,1450 | 0,0042 | 0,81 | 0,1450 | 0,0066 | 1,16 | 0,1658 | 0,0053 | 1,17 | 0,1658 | 0,008 |

| | | | | | | | | | | | | | | | | | | | | |
|------|-------------------------------------|-------------------------------------|------|--------|--------|------|--------|--------|------|--------|--------|------|--------|--------|-------|--------|--------|-------|--------|--------|
| A12- | Kufstein Nord | Staatsgrenze Kufstein | 0,36 | 0,0000 | 0,0000 | 0,36 | 0,0000 | 0,0000 | 0,51 | 0,0000 | 0,0000 | 0,51 | 0,0000 | 0,0000 | 0,76 | 0,0000 | 0,0000 | 0,76 | 0,0000 | 0,0000 |
| A12- | Kufstein Süd | Kufstein Nord | 0,93 | 0,0000 | 0,0000 | 0,93 | 0,0000 | 0,0000 | 1,31 | 0,0000 | 0,0000 | 1,31 | 0,0000 | 0,0000 | 1,96 | 0,0000 | 0,0000 | 1,96 | 0,0000 | 0,0000 |
| A12- | Kirchbichl Langkampfen | Kufstein Süd | 1,27 | 0,0000 | 0,0000 | 1,27 | 0,0000 | 0,0000 | 1,78 | 0,0000 | 0,0000 | 1,78 | 0,0000 | 0,0000 | 2,68 | 0,0000 | 0,0000 | 2,68 | 0,0000 | 0,0000 |
| A12- | Wörgl Ost St.Johann i. T. Brixental | Kirchbichl Langkampfen | 1,25 | 0,0000 | 0,0000 | 1,25 | 0,0000 | 0,0000 | 1,75 | 0,0000 | 0,0000 | 1,75 | 0,0000 | 0,0000 | 2,62 | 0,0000 | 0,0000 | 2,62 | 0,0000 | 0,0000 |
| A12- | Wörgl West | Wörgl Ost St.Johann i. T. Brixental | 0,66 | 0,0000 | 0,0000 | 0,66 | 0,0000 | 0,0000 | 0,92 | 0,0000 | 0,0000 | 0,92 | 0,0000 | 0,0000 | 1,38 | 0,0000 | 0,0000 | 1,38 | 0,0000 | 0,0000 |
| A12- | Kramsach Rattenberg Brixlegg | Wörgl West | 2,80 | 0,0000 | 0,0000 | 2,80 | 0,0000 | 0,0000 | 3,92 | 0,0000 | 0,0000 | 3,92 | 0,0000 | 0,0000 | 5,88 | 0,0000 | 0,0000 | 5,88 | 0,0000 | 0,0000 |
| A12- | Wiesing Achensee Zillertal | Kramsach Rattenberg Brixlegg | 1,72 | 0,0000 | 0,0000 | 1,72 | 0,0000 | 0,0000 | 2,40 | 0,0000 | 0,0000 | 2,40 | 0,0000 | 0,0000 | 3,61 | 0,0000 | 0,0000 | 3,61 | 0,0000 | 0,0000 |
| A12- | Jenbach | Wiesing Achensee Zillertal | 0,68 | 0,0000 | 0,0000 | 0,68 | 0,0000 | 0,0000 | 0,95 | 0,0000 | 0,0000 | 0,95 | 0,0000 | 0,0000 | 1,43 | 0,0000 | 0,0000 | 1,43 | 0,0000 | 0,0000 |
| A12- | Schwaz | Jenbach | 1,50 | 0,0000 | 0,0000 | 1,50 | 0,0000 | 0,0000 | 2,10 | 0,0000 | 0,0000 | 2,10 | 0,0000 | 0,0000 | 3,15 | 0,0000 | 0,0000 | 3,15 | 0,0000 | 0,0000 |
| A12- | Vomp | Schwaz | 0,86 | 0,0000 | 0,0000 | 0,86 | 0,0000 | 0,0000 | 1,20 | 0,0000 | 0,0000 | 1,20 | 0,0000 | 0,0000 | 1,80 | 0,0000 | 0,0000 | 1,80 | 0,0000 | 0,0000 |
| A12- | Wattens | Vomp | 1,77 | 0,0000 | 0,0000 | 1,77 | 0,0000 | 0,0000 | 2,47 | 0,0000 | 0,0000 | 2,47 | 0,0000 | 0,0000 | 3,71 | 0,0000 | 0,0000 | 3,71 | 0,0000 | 0,0000 |
| A12- | Hall/Tirol Mitte | Wattens | 1,57 | 0,0000 | 0,0000 | 1,57 | 0,0000 | 0,0000 | 2,19 | 0,0000 | 0,0000 | 2,19 | 0,0000 | 0,0000 | 3,29 | 0,0000 | 0,0000 | 3,29 | 0,0000 | 0,0000 |
| A12- | Hall/Tirol West | Hall/Tirol Mitte | 0,63 | 0,0000 | 0,0000 | 0,63 | 0,0000 | 0,0000 | 0,88 | 0,0000 | 0,0000 | 0,88 | 0,0000 | 0,0000 | 1,32 | 0,0000 | 0,0000 | 1,32 | 0,0000 | 0,0000 |
| A12- | A12 Innsbruck Ost | Hall/Tirol West | 0,70 | 0,0000 | 0,0000 | 0,70 | 0,0000 | 0,0000 | 0,97 | 0,0000 | 0,0000 | 0,97 | 0,0000 | 0,0000 | 1,46 | 0,0000 | 0,0000 | 1,46 | 0,0000 | 0,0000 |
| A12- | Innsbruck Mitte | A12 Innsbruck Ost | 0,48 | 0,0226 | 0,0004 | 0,48 | 0,0226 | 0,0006 | 0,67 | 0,0317 | 0,0009 | 0,67 | 0,0317 | 0,0014 | 0,99 | 0,0362 | 0,0011 | 0,99 | 0,0362 | 0,0018 |
| A12- | A12 Innsbruck West | Innsbruck Mitte | 0,71 | 0,1280 | 0,0022 | 0,71 | 0,1280 | 0,0035 | 1,00 | 0,1792 | 0,0052 | 1,00 | 0,1792 | 0,0081 | 1,44 | 0,2048 | 0,0065 | 1,44 | 0,2048 | 0,0102 |
| A12- | Innsbruck Kranebitten | A12 Innsbruck West | 0,93 | 0,1678 | 0,0029 | 0,94 | 0,1678 | 0,0046 | 1,31 | 0,2349 | 0,0068 | 1,32 | 0,2349 | 0,0106 | 1,88 | 0,2684 | 0,0085 | 1,89 | 0,2684 | 0,0134 |
| A12- | Zirl Ost Garmisch Seefeld | Innsbruck Kranebitten | 1,08 | 0,1947 | 0,0034 | 1,09 | 0,1947 | 0,0054 | 1,52 | 0,2726 | 0,0078 | 1,53 | 0,2726 | 0,0123 | 2,18 | 0,3115 | 0,0099 | 2,19 | 0,3115 | 0,0155 |
| A12- | Zirl West | Zirl Ost Garmisch Seefeld | 0,68 | 0,1218 | 0,0021 | 0,68 | 0,1218 | 0,0033 | 0,95 | 0,1705 | 0,0049 | 0,95 | 0,1705 | 0,0077 | 1,37 | 0,1949 | 0,0062 | 1,37 | 0,1949 | 0,0097 |
| A12- | Petttau | Zirl West | 1,22 | 0,2181 | 0,0038 | 1,22 | 0,2181 | 0,0060 | 1,71 | 0,3054 | 0,0088 | 1,71 | 0,3054 | 0,0138 | 2,45 | 0,3490 | 0,0111 | 2,45 | 0,3490 | 0,0174 |
| A12- | Telfs Ost | Petttau | 1,23 | 0,2205 | 0,0039 | 1,23 | 0,2205 | 0,0061 | 1,72 | 0,3087 | 0,0089 | 1,73 | 0,3087 | 0,0139 | 2,47 | 0,3528 | 0,0112 | 2,48 | 0,3528 | 0,0176 |
| A12- | Telfs West | Telfs Ost | 0,60 | 0,1077 | 0,0019 | 0,60 | 0,1077 | 0,0030 | 0,84 | 0,1508 | 0,0043 | 0,84 | 0,1508 | 0,0068 | 1,21 | 0,1723 | 0,0055 | 1,21 | 0,1723 | 0,0086 |
| A12- | Mötz Reutte | Telfs West | 1,94 | 0,3480 | 0,0061 | 1,94 | 0,3480 | 0,0096 | 2,72 | 0,4872 | 0,0140 | 2,73 | 0,4872 | 0,0220 | 3,90 | 0,5568 | 0,0177 | 3,91 | 0,5568 | 0,0278 |
| A12- | Haiming Ötztal | Mötz Reutte | 2,26 | 0,4048 | 0,0071 | 2,26 | 0,4048 | 0,0111 | 3,16 | 0,5667 | 0,0163 | 3,17 | 0,5667 | 0,0256 | 4,54 | 0,6477 | 0,0205 | 4,55 | 0,6477 | 0,0323 |
| A12- | Imst | Haiming Ötztal | 1,80 | 0,3222 | 0,0056 | 1,80 | 0,3222 | 0,0089 | 2,52 | 0,4511 | 0,0130 | 2,53 | 0,4511 | 0,0204 | 3,61 | 0,5156 | 0,0164 | 3,62 | 0,5156 | 0,0257 |
| A12- | Imst Au | Imst | 0,53 | 0,0950 | 0,0017 | 0,53 | 0,0950 | 0,0026 | 0,74 | 0,1331 | 0,0038 | 0,75 | 0,1331 | 0,0060 | 1,07 | 0,1521 | 0,0048 | 1,07 | 0,1521 | 0,0076 |
| A12- | Mils | Imst Au | 0,43 | 0,0767 | 0,0013 | 0,43 | 0,0767 | 0,0021 | 0,60 | 0,1074 | 0,0031 | 0,60 | 0,1074 | 0,0049 | 0,86 | 0,1228 | 0,0039 | 0,86 | 0,1228 | 0,0061 |
| A12- | Mils Schönwies | Mils | 1,05 | 0,1888 | 0,0033 | 1,05 | 0,1888 | 0,0052 | 1,48 | 0,2643 | 0,0076 | 1,48 | 0,2643 | 0,0119 | 2,12 | 0,3021 | 0,0096 | 2,12 | 0,3021 | 0,0151 |
| A12- | KN Oberinntal | Mils Schönwies | 0,93 | 0,1672 | 0,0029 | 0,93 | 0,1672 | 0,0046 | 1,31 | 0,2341 | 0,0067 | 1,31 | 0,2341 | 0,0106 | 1,88 | 0,2675 | 0,0085 | 1,88 | 0,2675 | 0,0133 |
| A12- | Zams | KN Oberinntal | 0,25 | 0,0440 | 0,0008 | 0,25 | 0,0440 | 0,0012 | 0,34 | 0,0616 | 0,0018 | 0,35 | 0,0616 | 0,0028 | 0,49 | 0,0704 | 0,0022 | 0,49 | 0,0704 | 0,0035 |
| A122 | Fließ | KN Oberinntal | 1,74 | 0,3128 | 0,0055 | 1,75 | 0,3128 | 0,0086 | 2,45 | 0,4379 | 0,0126 | 2,45 | 0,4379 | 0,0198 | 3,51 | 0,5005 | 0,0159 | 3,52 | 0,5005 | 0,0249 |
| A13- | A13 Innsbruck Süd | A12 Innsbruck Ost | 2,20 | 0,0000 | 0,0000 | 2,20 | 0,0000 | 0,0000 | 3,08 | 0,0000 | 0,0000 | 3,08 | 0,0000 | 0,0000 | 4,62 | 0,0000 | 0,0000 | 8,50 | 0,0000 | 0,0000 |
| A13- | Zenzenhof | A13 Innsbruck Süd | 0,88 | 0,0000 | 0,0000 | 0,88 | 0,0000 | 0,0000 | 1,23 | 0,0000 | 0,0000 | 1,23 | 0,0000 | 0,0000 | 1,84 | 0,0000 | 0,0000 | 3,68 | 0,0000 | 0,0000 |
| A13- | Igls Patsch | Zenzenhof | 1,62 | 0,0000 | 0,0000 | 1,62 | 0,0000 | 0,0000 | 2,27 | 0,0000 | 0,0000 | 2,27 | 0,0000 | 0,0000 | 3,41 | 0,0000 | 0,0000 | 6,82 | 0,0000 | 0,0000 |
| A13- | Schönberg Stubaital | Igls Patsch | 1,76 | 0,0000 | 0,0000 | 1,76 | 0,0000 | 0,0000 | 2,46 | 0,0000 | 0,0000 | 2,46 | 0,0000 | 0,0000 | 3,69 | 0,0000 | 0,0000 | 7,38 | 0,0000 | 0,0000 |
| A13- | Matrei Steinach | Schönberg Stubaital | 5,54 | 0,0000 | 0,0000 | 5,54 | 0,0000 | 0,0000 | 7,76 | 0,0000 | 0,0000 | 7,76 | 0,0000 | 0,0000 | 11,63 | 0,0000 | 0,0000 | 23,26 | 0,0000 | 0,0000 |
| A13- | Nösslach | Matrei Steinach | 4,46 | 0,0000 | 0,0000 | 4,46 | 0,0000 | 0,0000 | 6,24 | 0,0000 | 0,0000 | 6,24 | 0,0000 | 0,0000 | 9,36 | 0,0000 | 0,0000 | 18,72 | 0,0000 | 0,0000 |
| A13- | Brenner-Nord | Nösslach | 4,00 | 0,0000 | 0,0000 | 4,00 | 0,0000 | 0,0000 | 5,60 | 0,0000 | 0,0000 | 5,60 | 0,0000 | 0,0000 | 8,40 | 0,0000 | 0,0000 | 16,80 | 0,0000 | 0,0000 |
| A13- | Staatsgrenze Brennerpass | Brenner-Nord | 0,79 | 0,0000 | 0,0000 | 0,79 | 0,0000 | 0,0000 | 1,11 | 0,0000 | 0,0000 | 1,11 | 0,0000 | 0,0000 | 1,66 | 0,0000 | 0,0000 | 3,32 | 0,0000 | 0,0000 |
| A131 | A13 Innsbruck Süd | A12 Innsbruck West | 1,43 | 0,0416 | 0,0007 | 1,43 | 0,0416 | 0,0011 | 2,01 | 0,0583 | 0,0017 | 2,01 | 0,0583 | 0,0026 | 2,99 | 0,0666 | 0,0021 | 5,51 | 0,0666 | 0,0033 |
| A14- | Hörbranz Lochau | Staatsgrenze Hörbranz | 0,28 | 0,0504 | 0,0009 | 0,28 | 0,0504 | 0,0014 | 0,39 | 0,0706 | 0,0020 | 0,40 | 0,0706 | 0,0032 | 0,57 | 0,0807 | 0,0026 | 0,57 | 0,0807 | 0,0040 |
| A14- | KN Bregenz | Hörbranz Lochau | 1,73 | 0,3100 | 0,0054 | 1,73 | 0,3100 | 0,0085 | 2,42 | 0,4339 | 0,0125 | 2,43 | 0,4339 | 0,0196 | 3,48 | 0,4959 | 0,0157 | 3,49 | 0,4959 | 0,0247 |
| A14- | Lauterach Wolfurt | KN Bregenz | 0,09 | 0,0156 | 0,0003 | 0,09 | 0,0156 | 0,0004 | 0,12 | 0,0218 | 0,0006 | 0,12 | 0,0218 | 0,0010 | 0,17 | 0,0249 | 0,0008 | 0,17 | 0,0249 | 0,0012 |
| A14- | Wolfurt Lauterach | Lauterach Wolfurt | 0,77 | 0,1379 | 0,0024 | 0,77 | 0,1379 | 0,0038 | 1,08 | 0,1931 | 0,0056 | 1,08 | 0,1931 | 0,0087 | 1,55 | 0,2207 | 0,0070 | 1,55 | 0,2207 | 0,0110 |
| A14- | Dornbirn Nord Bregenzerwald | Wolfurt Lauterach | 0,30 | 0,0534 | 0,0009 | 0,30 | 0,0534 | 0,0015 | 0,42 | 0,0747 | 0,0021 | 0,42 | 0,0747 | 0,0034 | 0,60 | 0,0854 | 0,0027 | 0,60 | 0,0854 | 0,0043 |
| A14- | Dornbirn Süd Lustenau | Dornbirn Nord Bregenzerwald | 0,83 | 0,1491 | 0,0026 | 0,83 | 0,1491 | 0,0041 | 1,17 | 0,2087 | 0,0060 | 1,17 | 0,2087 | 0,0094 | 1,67 | 0,2385 | 0,0076 | 1,68 | 0,2385 | 0,0119 |
| A14- | Hohenems | Dornbirn Süd Lustenau | 1,17 | 0,2098 | 0,0037 | 1,17 | 0,2098 | 0,0058 | 1,64 | 0,2937 | 0,0084 | 1,64 | 0,2937 | 0,0133 | 2,35 | 0,3356 | 0,0106 | 2,36 | 0,3356 | 0,0167 |
| A14- | Altach Götzis | Hohenems | 0,76 | 0,1368 | 0,0024 | 0,76 | 0,1368 | 0,0038 | 1,07 | 0,1915 | 0,0055 | 1,07 | 0,1915 | 0,0087 | 1,53 | 0,2188 | 0,0069 | 1,54 | 0,2188 | 0,0109 |
| A14- | Götzis | Altach Götzis | 0,58 | 0,1043 | 0,0018 | 0,58 | 0,1043 | 0,0029 | 0,82 | 0,1460 | 0,0042 | 0,82 | 0,1460 | 0,0066 | 1,17 | 0,1668 | 0,0053 | 1,17 | 0,1668 | 0,0083 |
| A14- | Klaus Koblach | Götzis | 0,50 | 0,0906 | 0,0016 | 0,51 | 0,0906 | 0,0025 | 0,71 | 0,1268 | 0,0036 | 0,71 | 0,1268 | 0,0057 | 1,02 | 0,1449 | 0,0046 | 1,02 | 0,1449 | 0,0072 |
| A14- | Rankweil | Klaus Koblach | 0,89 | 0,1592 | 0,0028 | 0,89 | 0,1592 | 0,0044 | 1,24 | 0,2228 | 0,0064 | 1,25 | 0,2228 | 0,0101 | 1,79 | 0,2547 | 0,0081 | 1,79 | 0,2547 | 0,0127 |
| A14- | Feldkirch Frastanz | Rankweil | 1,26 | 0,2267 | 0,0040 | 1,27 | 0,2267 | 0,0062 | 1,77 | 0,3174 | 0,0091 | 1,78 | 0,3174 | 0,0143 | 2,54 | 0,3628 | 0,0115 | 2,55 | 0,3628 | 0,0181 |
| A14- | Nenzing Bludesch | Feldkirch Frastanz | 2,00 | 0,3585 | 0,0063 | 2,00 | 0,3585 | 0,0099 | 2,80 | 0,5019 | 0,0144 | 2,81 | 0,5019 | 0,0227 | 4,02 | 0,5736 | 0,0182 | 4,03 | 0,5736 | 0,0286 |
| A14- | Bludenz Nüziders | Nenzing Bludesch | 1,48 | 0,2662 | 0,0047 | 1,49 | 0,2662 | 0,0073 | 2,08 | 0,3726 | 0,0107 | 2,09 | 0,3726 | 0,0168 | 2,99 | 0,4259 | 0,0135 | 2,99 | 0,4259 | 0,0212 |
| A14- | Brandnertal | Bludenz Nüziders | 0,21 | 0,0370 | 0,0006 | 0,21 | 0,0370 | 0,0010 | 0,29 | 0,0519 | 0,0015 | 0,29 | 0,0519 | 0,0023 | 0,42 | 0,0593 | 0,0019 | 0,42 | 0,0593 | 0,0030 |
| A14- | Bludenz Bürs | Brandnertal | 0,34 | 0,0618 | 0,0011 | 0,35 | 0,0618 | 0,0017 | 0,48 | 0,0865 | 0,0025 | 0,48 | 0,0865 | 0,0039 | 0,69 | 0,0989 | 0,0031 | 0,69 | 0,0989 | 0,0049 |
| A14- | Bludenz Montafon | Bludenz Bürs | 0,49 | 0,08 | | | | | | | | | | | | | | | | |

| | | | | | | | | | | | | | | | | | | | | |
|--------|--------------------------------------|--------------------------------------|------|--------|--------|------|--------|--------|------|--------|--------|------|--------|--------|------|--------|--------|------|--------|--------|
| A22- | Strebersdorf | KN Gürtel Nordbrücke | 0,67 | 0,1203 | 0,0021 | 0,67 | 0,1203 | 0,0033 | 0,94 | 0,1684 | 0,0048 | 0,94 | 0,1684 | 0,0076 | 1,35 | 0,1925 | 0,0061 | 1,35 | 0,1925 | 0,0096 |
| A221 | KN Gürtel Nordbrücke | Wien Nordbrücke | 0,20 | 0,0355 | 0,0006 | 0,20 | 0,0355 | 0,0010 | 0,28 | 0,0497 | 0,0014 | 0,28 | 0,0497 | 0,0022 | 0,40 | 0,0568 | 0,0018 | 0,40 | 0,0568 | 0,0028 |
| A221 | Wien Pragerstraße | KN Gürtel Nordbrücke | 0,21 | 0,0382 | 0,0007 | 0,21 | 0,0382 | 0,0011 | 0,30 | 0,0535 | 0,0015 | 0,30 | 0,0535 | 0,0024 | 0,43 | 0,0611 | 0,0019 | 0,43 | 0,0611 | 0,0030 |
| A221 | Wien Neujedlersdorf | Wien Pragerstraße | 0,09 | 0,0167 | 0,0003 | 0,09 | 0,0167 | 0,0005 | 0,13 | 0,0234 | 0,0007 | 0,13 | 0,0234 | 0,0011 | 0,19 | 0,0268 | 0,0008 | 0,19 | 0,0268 | 0,0013 |
| A221 | Brünnerstr/Shuttlewort hstraße | Wien Neujedlersdorf | 0,24 | 0,0424 | 0,0007 | 0,24 | 0,0424 | 0,0012 | 0,33 | 0,0594 | 0,0017 | 0,33 | 0,0594 | 0,0027 | 0,48 | 0,0678 | 0,0022 | 0,48 | 0,0678 | 0,0034 |
| A22- | Korneuburg Ost | Strebersdorf | 1,35 | 0,2424 | 0,0042 | 1,35 | 0,2424 | 0,0067 | 1,90 | 0,3394 | 0,0098 | 1,90 | 0,3394 | 0,0153 | 2,72 | 0,3878 | 0,0123 | 2,72 | 0,3878 | 0,0193 |
| A222 | Wien Vohburggasse | Strebersdorf | 0,17 | 0,0301 | 0,0005 | 0,17 | 0,0301 | 0,0008 | 0,24 | 0,0422 | 0,0012 | 0,24 | 0,0422 | 0,0019 | 0,34 | 0,0482 | 0,0015 | 0,34 | 0,0482 | 0,0024 |
| A22- | KN Korneuburg | Korneuburg Ost | 0,87 | 0,1564 | 0,0027 | 0,87 | 0,1564 | 0,0043 | 1,22 | 0,2190 | 0,0063 | 1,23 | 0,2190 | 0,0099 | 1,75 | 0,2503 | 0,0079 | 1,76 | 0,2503 | 0,0125 |
| A22- | Stockerau Ost | KN Korneuburg | 1,27 | 0,2276 | 0,0040 | 1,27 | 0,2276 | 0,0063 | 1,78 | 0,3186 | 0,0092 | 1,78 | 0,3186 | 0,0144 | 2,55 | 0,3642 | 0,0116 | 2,56 | 0,3642 | 0,0182 |
| A22- | Stockerau Mitte | Stockerau Ost | 0,51 | 0,0908 | 0,0016 | 0,51 | 0,0908 | 0,0025 | 0,71 | 0,1271 | 0,0037 | 0,71 | 0,1271 | 0,0057 | 1,02 | 0,1452 | 0,0046 | 1,02 | 0,1452 | 0,0072 |
| A22- | KN Stockerau/West | Stockerau Mitte | 0,43 | 0,0771 | 0,0013 | 0,43 | 0,0771 | 0,0021 | 0,60 | 0,1079 | 0,0031 | 0,60 | 0,1079 | 0,0049 | 0,86 | 0,1233 | 0,0039 | 0,87 | 0,1233 | 0,0061 |
| A23- | KN Wien Inzersdorf | Altmannsdorferstraße | 0,38 | 0,0674 | 0,0012 | 0,38 | 0,0674 | 0,0019 | 0,53 | 0,0944 | 0,0027 | 0,53 | 0,0944 | 0,0043 | 0,76 | 0,1079 | 0,0034 | 0,76 | 0,1079 | 0,0054 |
| A23- | Favoriten | KN Wien Inzersdorf | 0,95 | 0,1701 | 0,0030 | 0,95 | 0,1701 | 0,0047 | 1,33 | 0,2381 | 0,0068 | 1,33 | 0,2381 | 0,0108 | 1,91 | 0,2721 | 0,0086 | 1,91 | 0,2721 | 0,0136 |
| A23- | KN Gürtel Landstraßer Hauptstraße | Favoriten | 0,59 | 0,1065 | 0,0019 | 0,59 | 0,1065 | 0,0029 | 0,83 | 0,1491 | 0,0043 | 0,84 | 0,1491 | 0,0067 | 1,19 | 0,1704 | 0,0054 | 1,20 | 0,1704 | 0,0085 |
| A23- | St. Marx | KN Gürtel Landstraßer Hauptstraße | 0,23 | 0,0404 | 0,0007 | 0,23 | 0,0404 | 0,0011 | 0,32 | 0,0566 | 0,0016 | 0,32 | 0,0566 | 0,0026 | 0,45 | 0,0647 | 0,0021 | 0,45 | 0,0647 | 0,0032 |
| A23- | KN Wien Prater | St. Marx | 0,19 | 0,0343 | 0,0006 | 0,19 | 0,0343 | 0,0009 | 0,27 | 0,0480 | 0,0014 | 0,27 | 0,0480 | 0,0022 | 0,38 | 0,0549 | 0,0017 | 0,39 | 0,0549 | 0,0027 |
| A23- | Handelskai | KN Wien Prater | 0,42 | 0,0762 | 0,0013 | 0,43 | 0,0762 | 0,0021 | 0,60 | 0,1067 | 0,0031 | 0,60 | 0,1067 | 0,0048 | 0,85 | 0,1219 | 0,0039 | 0,86 | 0,1219 | 0,0061 |
| A23- | KN Wien Kaisermühlen | Handelskai | 0,19 | 0,0348 | 0,0006 | 0,19 | 0,0348 | 0,0010 | 0,27 | 0,0488 | 0,0014 | 0,27 | 0,0488 | 0,0022 | 0,39 | 0,0557 | 0,0018 | 0,39 | 0,0557 | 0,0028 |
| A23- | Groß Enzersdorf Stadlau | KN Wien Kaisermühlen | 0,53 | 0,0956 | 0,0017 | 0,53 | 0,0956 | 0,0026 | 0,75 | 0,1338 | 0,0038 | 0,75 | 0,1338 | 0,0060 | 1,07 | 0,1530 | 0,0049 | 1,08 | 0,1530 | 0,0076 |
| A23- | Hirschstetten | Groß Enzersdorf Stadlau | 0,30 | 0,0536 | 0,0009 | 0,30 | 0,0536 | 0,0015 | 0,42 | 0,0750 | 0,0022 | 0,42 | 0,0750 | 0,0034 | 0,60 | 0,0858 | 0,0027 | 0,60 | 0,0858 | 0,0043 |
| A233 | Wien Gürtel | KN Gürtel Landstraßer Hauptstraße | 0,17 | 0,0313 | 0,0005 | 0,17 | 0,0313 | 0,0009 | 0,24 | 0,0438 | 0,0013 | 0,25 | 0,0438 | 0,0020 | 0,35 | 0,0500 | 0,0016 | 0,35 | 0,0500 | 0,0025 |
| A25- | Weißkirchen | KN A1/A25 Passau Wels | 1,96 | 0,3526 | 0,0062 | 1,97 | 0,3526 | 0,0097 | 2,76 | 0,4936 | 0,0142 | 2,76 | 0,4936 | 0,0223 | 3,95 | 0,5642 | 0,0179 | 3,97 | 0,5642 | 0,0281 |
| A25- | Marchtrenk Wels Ost | Weißkirchen | 0,70 | 0,1256 | 0,0022 | 0,70 | 0,1256 | 0,0035 | 0,98 | 0,1759 | 0,0051 | 0,99 | 0,1759 | 0,0079 | 1,41 | 0,2010 | 0,0064 | 1,41 | 0,2010 | 0,0100 |
| A25- | ÖBB Terminal Wels | Marchtrenk Wels Ost | 0,19 | 0,0338 | 0,0006 | 0,19 | 0,0338 | 0,0009 | 0,26 | 0,0473 | 0,0014 | 0,26 | 0,0473 | 0,0021 | 0,38 | 0,0541 | 0,0017 | 0,38 | 0,0541 | 0,0027 |
| A25- | Wels Nord | ÖBB Terminal Wels | 0,90 | 0,1620 | 0,0028 | 0,90 | 0,1620 | 0,0045 | 1,27 | 0,2269 | 0,0065 | 1,27 | 0,2269 | 0,0102 | 1,82 | 0,2593 | 0,0082 | 1,82 | 0,2593 | 0,0129 |
| A25- | KN Wels | Wels Nord | 0,64 | 0,1153 | 0,0020 | 0,64 | 0,1153 | 0,0032 | 0,90 | 0,1614 | 0,0046 | 0,90 | 0,1614 | 0,0073 | 1,29 | 0,1844 | 0,0059 | 1,30 | 0,1844 | 0,0092 |
| S01- | Vorarlberger Allee | KN Vösendorf | 0,48 | 0,0855 | 0,0015 | 0,48 | 0,0855 | 0,0024 | 0,67 | 0,1197 | 0,0034 | 0,67 | 0,1197 | 0,0054 | 0,96 | 0,1368 | 0,0043 | 0,96 | 0,1368 | 0,0068 |
| S01- | Laxenburger Str. | Vorarlberger Allee | 0,25 | 0,0449 | 0,0008 | 0,25 | 0,0449 | 0,0012 | 0,35 | 0,0628 | 0,0018 | 0,35 | 0,0628 | 0,0028 | 0,50 | 0,0718 | 0,0023 | 0,50 | 0,0718 | 0,0036 |
| S01- | Güterzentrum Wien Süd | Laxenburger Str. | 0,31 | 0,0556 | 0,0010 | 0,31 | 0,0556 | 0,0015 | 0,43 | 0,0779 | 0,0022 | 0,44 | 0,0779 | 0,0035 | 0,62 | 0,0890 | 0,0028 | 0,63 | 0,0890 | 0,0044 |
| S01- | Rothneusiedl | Güterzentrum Wien Süd | 0,20 | 0,0362 | 0,0006 | 0,20 | 0,0362 | 0,0010 | 0,28 | 0,0506 | 0,0015 | 0,28 | 0,0506 | 0,0023 | 0,41 | 0,0579 | 0,0018 | 0,41 | 0,0579 | 0,0029 |
| S01- | KN Rustenfeld | Rothneusiedl | 0,47 | 0,0846 | 0,0015 | 0,47 | 0,0846 | 0,0023 | 0,66 | 0,1184 | 0,0034 | 0,66 | 0,1184 | 0,0054 | 0,95 | 0,1354 | 0,0043 | 0,95 | 0,1354 | 0,0067 |
| S01- | Rannersdorf | KN Rustenfeld | 0,66 | 0,1187 | 0,0021 | 0,66 | 0,1187 | 0,0033 | 0,93 | 0,1662 | 0,0048 | 0,93 | 0,1662 | 0,0075 | 1,33 | 0,1900 | 0,0060 | 1,34 | 0,1900 | 0,0095 |
| S011 | Leopoldsdorf (B16) | KN Rustenfeld | 0,29 | 0,0526 | 0,0009 | 0,29 | 0,0526 | 0,0014 | 0,41 | 0,0736 | 0,0021 | 0,41 | 0,0736 | 0,0033 | 0,59 | 0,0842 | 0,0027 | 0,59 | 0,0842 | 0,0042 |
| S01- | Schwechat Süd | Rannersdorf | 0,52 | 0,0928 | 0,0016 | 0,52 | 0,0928 | 0,0026 | 0,73 | 0,1299 | 0,0037 | 0,73 | 0,1299 | 0,0059 | 1,04 | 0,1484 | 0,0047 | 1,04 | 0,1484 | 0,0074 |
| S01- | Schwechat Ost | Schwechat Süd | 0,30 | 0,0531 | 0,0009 | 0,30 | 0,0531 | 0,0015 | 0,42 | 0,0744 | 0,0021 | 0,42 | 0,0744 | 0,0034 | 0,60 | 0,0850 | 0,0027 | 0,60 | 0,0850 | 0,0042 |
| S01- | Mannswörth | Schwechat Ost | 0,31 | 0,0562 | 0,0010 | 0,31 | 0,0562 | 0,0015 | 0,44 | 0,0787 | 0,0023 | 0,44 | 0,0787 | 0,0036 | 0,63 | 0,0900 | 0,0029 | 0,63 | 0,0900 | 0,0045 |
| S01- | KN Schwechat | Mannswörth | 0,12 | 0,0211 | 0,0004 | 0,12 | 0,0211 | 0,0006 | 0,16 | 0,0295 | 0,0008 | 0,17 | 0,0295 | 0,0013 | 0,24 | 0,0337 | 0,0011 | 0,24 | 0,0337 | 0,0017 |
| S01- | Seyring | Angerner Straße | 1,10 | 0,1971 | 0,0034 | 1,10 | 0,1971 | 0,0054 | 1,54 | 0,2759 | 0,0079 | 1,55 | 0,2759 | 0,0125 | 2,21 | 0,3153 | 0,0100 | 2,22 | 0,3153 | 0,0157 |
| S01- | KN Eibesbrunn | Seyring | 0,92 | 0,1649 | 0,0029 | 0,92 | 0,1649 | 0,0045 | 1,29 | 0,2308 | 0,0066 | 1,29 | 0,2308 | 0,0104 | 1,85 | 0,2638 | 0,0084 | 1,85 | 0,2638 | 0,0131 |
| S01- | Hagenbrunn | KN Eibesbrunn | 0,72 | 0,1298 | 0,0023 | 0,72 | 0,1298 | 0,0036 | 1,01 | 0,1817 | 0,0052 | 1,02 | 0,1817 | 0,0082 | 1,46 | 0,2077 | 0,0066 | 1,46 | 0,2077 | 0,0104 |
| S01- | Korneuburg Nord | Hagenbrunn | 1,55 | 0,2777 | 0,0049 | 1,55 | 0,2777 | 0,0076 | 2,17 | 0,3888 | 0,0112 | 2,18 | 0,3888 | 0,0176 | 3,11 | 0,4443 | 0,0141 | 3,12 | 0,4443 | 0,0221 |
| S01- | Korneuburg West | Korneuburg Nord | 0,63 | 0,1126 | 0,0020 | 0,63 | 0,1126 | 0,0031 | 0,88 | 0,1577 | 0,0045 | 0,88 | 0,1577 | 0,0071 | 1,26 | 0,1802 | 0,0057 | 1,27 | 0,1802 | 0,0090 |
| S01- | KN Korneuburg | Korneuburg West | 0,20 | 0,0359 | 0,0006 | 0,20 | 0,0359 | 0,0010 | 0,28 | 0,0503 | 0,0014 | 0,28 | 0,0503 | 0,0023 | 0,40 | 0,0575 | 0,0018 | 0,40 | 0,0575 | 0,0029 |
| S02- | Gewerbepark Stadlau | Hirschstetten | 0,22 | 0,0386 | 0,0007 | 0,22 | 0,0386 | 0,0011 | 0,30 | 0,0540 | 0,0016 | 0,30 | 0,0540 | 0,0024 | 0,43 | 0,0618 | 0,0020 | 0,43 | 0,0618 | 0,0031 |
| S02- | Breitenleer Straße | Gewerbepark Stadlau | 0,12 | 0,0214 | 0,0004 | 0,12 | 0,0214 | 0,0006 | 0,17 | 0,0300 | 0,0009 | 0,17 | 0,0300 | 0,0014 | 0,24 | 0,0342 | 0,0011 | 0,24 | 0,0342 | 0,0017 |
| S02- | Rautenweg | Breitenleer Straße | 0,20 | 0,0355 | 0,0006 | 0,20 | 0,0355 | 0,0010 | 0,28 | 0,0497 | 0,0014 | 0,28 | 0,0497 | 0,0022 | 0,40 | 0,0568 | 0,0018 | 0,40 | 0,0568 | 0,0028 |
| S02- | Hermann Gebauer Straße | Rautenweg | 0,22 | 0,0390 | 0,0007 | 0,22 | 0,0390 | 0,0011 | 0,31 | 0,0547 | 0,0016 | 0,31 | 0,0547 | 0,0025 | 0,44 | 0,0625 | 0,0020 | 0,44 | 0,0625 | 0,0031 |
| S02- | Angerner Straße | Hermann Gebauer Straße | 0,79 | 0,1413 | 0,0025 | 0,79 | 0,1413 | 0,0039 | 1,10 | 0,1978 | 0,0057 | 1,11 | 0,1978 | 0,0089 | 1,58 | 0,2260 | 0,0072 | 1,59 | 0,2260 | 0,0113 |
| S03- | Stockerau Nord | KN Stockerau/West | 0,22 | 0,0399 | 0,0007 | 0,22 | 0,0399 | 0,0011 | 0,31 | 0,0559 | 0,0016 | 0,31 | 0,0559 | 0,0025 | 0,45 | 0,0639 | 0,0020 | 0,45 | 0,0639 | 0,0032 |
| S03- | Sierndorf | Stockerau Nord | 1,20 | 0,2146 | 0,0038 | 1,20 | 0,2146 | 0,0059 | 1,68 | 0,3004 | 0,0086 | 1,68 | 0,3004 | 0,0136 | 2,41 | 0,3433 | 0,0109 | 2,41 | 0,3433 | 0,0171 |
| S03- | Obermallebarn | Sierndorf | 0,80 | 0,1441 | 0,0025 | 0,80 | 0,1441 | 0,0040 | 1,13 | 0,2017 | 0,0058 | 1,13 | 0,2017 | 0,0091 | 1,62 | 0,2305 | 0,0073 | 1,62 | 0,2305 | 0,0115 |
| S03- | Göllersdorf | Obermallebarn | 1,06 | 0,1902 | 0,0033 | 1,06 | 0,1902 | 0,0052 | 1,49 | 0,2663 | 0,0077 | 1,49 | 0,2663 | 0,0120 | 2,13 | 0,3044 | 0,0097 | 2,14 | 0,3044 | 0,0152 |
| S03- | Großstelzendorf | Göllersdorf | 0,42 | 0,0762 | 0,0013 | 0,43 | 0,0762 | 0,0021 | 0,60 | 0,1067 | 0,0031 | 0,60 | 0,1067 | 0,0048 | 0,85 | 0,1219 | 0,0039 | 0,86 | 0,1219 | 0,0061 |
| S03- | Hollabrunn Süd | Großstelzendorf | 1,02 | 0,1832 | 0,0032 | 1,02 | 0,1832 | 0,0050 | 1,43 | 0,2565 | 0,0074 | 1,44 | 0,2565 | 0,0116 | 2,06 | 0,2932 | 0,0093 | 2,06 | 0,2932 | 0,0146 |
| S04- | Sigleß | KN Mattersburg | 0,53 | 0,0947 | 0,0017 | 0,53 | 0,0947 | 0,0026 | 0,74 | 0,1326 | 0,0038 | 0,74 | 0,1326 | 0,0060 | 1,06 | 0,1516 | 0,0048 | 1,07 | 0,1516 | 0,0076 |
| S04- | Bad Sauerbrunn | Sigleß | 1,23 | 0,2213 | 0,0039 | 1,24 | 0,2213 | 0,0061 | 1,73 | 0,3098 | 0,0089 | 1,74 | 0,3098 | 0,0140 | 2,48 | 0,3541 | 0,0112 | 2,49 | 0,3541 | 0,0177 |
| S04-</ | | | | | | | | | | | | | | | | | | | | |

| | | | | | | | | | | | | | | | | | | | | |
|------|-----------------------------------|-----------------------------------|------|--------|--------|------|--------|--------|-------|--------|--------|-------|--------|--------|-------|--------|--------|-------|--------|--------|
| S06- | Gloggnitz | Neunkirchen | 2,71 | 0,4868 | 0,0085 | 2,72 | 0,4868 | 0,0134 | 3,81 | 0,6815 | 0,0196 | 3,82 | 0,6815 | 0,0308 | 5,46 | 0,7789 | 0,0247 | 5,47 | 0,7789 | 0,0388 |
| S06- | Maria Schutz | Gloggnitz | 1,73 | 0,3103 | 0,0054 | 1,73 | 0,3103 | 0,0085 | 2,43 | 0,4344 | 0,0125 | 2,43 | 0,4344 | 0,0196 | 3,48 | 0,4964 | 0,0157 | 3,49 | 0,4964 | 0,0247 |
| S06- | Spital / Semmering | Maria Schutz | 1,47 | 0,2634 | 0,0046 | 1,47 | 0,2634 | 0,0072 | 2,06 | 0,3687 | 0,0106 | 2,06 | 0,3687 | 0,0167 | 2,95 | 0,4214 | 0,0134 | 2,96 | 0,4214 | 0,0210 |
| S06- | Mürzzuschlag Ost | Spital / Semmering | 1,23 | 0,2200 | 0,0039 | 1,23 | 0,2200 | 0,0061 | 1,72 | 0,3080 | 0,0089 | 1,72 | 0,3080 | 0,0139 | 2,47 | 0,3520 | 0,0112 | 2,47 | 0,3520 | 0,0175 |
| S06- | Mariazell, Mürzsteg, Mürzzuschlag | Mürzzuschlag Ost | 1,09 | 0,1950 | 0,0034 | 1,09 | 0,1950 | 0,0054 | 1,52 | 0,2731 | 0,0079 | 1,53 | 0,2731 | 0,0123 | 2,19 | 0,3121 | 0,0099 | 2,19 | 0,3121 | 0,0156 |
| S06- | Hönigsberg | Mariazell, Mürzsteg, Mürzzuschlag | 0,78 | 0,1391 | 0,0024 | 0,78 | 0,1391 | 0,0038 | 1,09 | 0,1947 | 0,0056 | 1,09 | 0,1947 | 0,0088 | 1,56 | 0,2225 | 0,0071 | 1,56 | 0,2225 | 0,0111 |
| S06- | Langenwang | Hönigsberg | 0,43 | 0,0769 | 0,0013 | 0,43 | 0,0769 | 0,0021 | 0,60 | 0,1077 | 0,0031 | 0,60 | 0,1077 | 0,0049 | 0,86 | 0,1231 | 0,0039 | 0,87 | 0,1231 | 0,0061 |
| S06- | Krieglach | Langenwang | 0,51 | 0,0914 | 0,0016 | 0,51 | 0,0914 | 0,0025 | 0,71 | 0,1279 | 0,0037 | 0,72 | 0,1279 | 0,0058 | 1,02 | 0,1462 | 0,0046 | 1,03 | 0,1462 | 0,0073 |
| S06- | Mitterdorf | Krieglach | 1,29 | 0,2309 | 0,0040 | 1,29 | 0,2309 | 0,0064 | 1,81 | 0,3233 | 0,0093 | 1,81 | 0,3233 | 0,0146 | 2,59 | 0,3695 | 0,0117 | 2,60 | 0,3695 | 0,0184 |
| S06- | Kindberg Ost | Mitterdorf | 1,31 | 0,2348 | 0,0041 | 1,31 | 0,2348 | 0,0065 | 1,84 | 0,3287 | 0,0095 | 1,84 | 0,3287 | 0,0149 | 2,63 | 0,3757 | 0,0119 | 2,64 | 0,3757 | 0,0187 |
| S06- | Kindberg West | Kindberg Ost | 0,28 | 0,0504 | 0,0009 | 0,28 | 0,0504 | 0,0014 | 0,39 | 0,0706 | 0,0020 | 0,40 | 0,0706 | 0,0032 | 0,57 | 0,0806 | 0,0026 | 0,57 | 0,0806 | 0,0040 |
| S06- | Kindberg Dörfel | Kindberg West | 0,28 | 0,0504 | 0,0009 | 0,28 | 0,0504 | 0,0014 | 0,39 | 0,0705 | 0,0020 | 0,39 | 0,0705 | 0,0032 | 0,56 | 0,0806 | 0,0026 | 0,57 | 0,0806 | 0,0040 |
| S06- | Allerheiligen Mürzhofen | Kindberg Dörfel | 0,63 | 0,1134 | 0,0020 | 0,63 | 0,1134 | 0,0031 | 0,89 | 0,1588 | 0,0046 | 0,89 | 0,1588 | 0,0072 | 1,27 | 0,1815 | 0,0058 | 1,28 | 0,1815 | 0,0090 |
| S06- | St. Marein | Allerheiligen Mürzhofen | 0,95 | 0,1704 | 0,0030 | 0,95 | 0,1704 | 0,0047 | 1,33 | 0,2386 | 0,0069 | 1,34 | 0,2386 | 0,0108 | 1,91 | 0,2726 | 0,0086 | 1,92 | 0,2726 | 0,0136 |
| S06- | Kapfenberg | St. Marein | 0,67 | 0,1208 | 0,0021 | 0,67 | 0,1208 | 0,0033 | 0,94 | 0,1691 | 0,0049 | 0,95 | 0,1691 | 0,0076 | 1,35 | 0,1933 | 0,0061 | 1,36 | 0,1933 | 0,0096 |
| S06- | KN Bruck/Mur | Kapfenberg | 1,26 | 0,2255 | 0,0039 | 1,26 | 0,2255 | 0,0062 | 1,76 | 0,3157 | 0,0091 | 1,77 | 0,3157 | 0,0143 | 2,53 | 0,3608 | 0,0114 | 2,54 | 0,3608 | 0,0180 |
| S06- | ASt Bruck/Mur | KN Bruck/Mur | 1,08 | 0,1934 | 0,0034 | 1,08 | 0,1934 | 0,0053 | 1,51 | 0,2708 | 0,0078 | 1,52 | 0,2708 | 0,0122 | 2,17 | 0,3095 | 0,0098 | 2,18 | 0,3095 | 0,0154 |
| S06- | Niklasdorf | ASt Bruck/Mur | 1,00 | 0,1787 | 0,0031 | 1,00 | 0,1787 | 0,0049 | 1,40 | 0,2502 | 0,0072 | 1,40 | 0,2502 | 0,0113 | 2,00 | 0,2860 | 0,0091 | 2,01 | 0,2860 | 0,0143 |
| S06- | Leoben Ost | Niklasdorf | 1,06 | 0,1906 | 0,0033 | 1,06 | 0,1906 | 0,0052 | 1,49 | 0,2669 | 0,0077 | 1,49 | 0,2669 | 0,0121 | 2,14 | 0,3050 | 0,0097 | 2,14 | 0,3050 | 0,0152 |
| S06- | Leoben West | Leoben Ost | 1,19 | 0,2136 | 0,0037 | 1,19 | 0,2136 | 0,0059 | 1,67 | 0,2990 | 0,0086 | 1,67 | 0,2990 | 0,0135 | 2,40 | 0,3417 | 0,0108 | 2,40 | 0,3417 | 0,0170 |
| S06- | KN St. Michael | Leoben West | 1,47 | 0,2644 | 0,0046 | 1,48 | 0,2644 | 0,0073 | 2,07 | 0,3701 | 0,0106 | 2,07 | 0,3701 | 0,0167 | 2,97 | 0,4230 | 0,0134 | 2,97 | 0,4230 | 0,0211 |
| S10- | Neumarkt | Unterweirdersdorf | 1,49 | 0,2679 | 0,0047 | 1,50 | 0,2679 | 0,0074 | 2,09 | 0,3750 | 0,0108 | 2,10 | 0,3750 | 0,0169 | 3,00 | 0,4286 | 0,0136 | 3,01 | 0,4286 | 0,0214 |
| S10- | Kefermarkt | Neumarkt | 0,86 | 0,1538 | 0,0027 | 0,86 | 0,1538 | 0,0042 | 1,20 | 0,2154 | 0,0062 | 1,21 | 0,2154 | 0,0097 | 1,73 | 0,2461 | 0,0078 | 1,73 | 0,2461 | 0,0123 |
| S10- | Freistadt / Süd | Kefermarkt | 0,92 | 0,1655 | 0,0029 | 0,92 | 0,1655 | 0,0046 | 1,29 | 0,2317 | 0,0067 | 1,30 | 0,2317 | 0,0105 | 1,86 | 0,2648 | 0,0084 | 1,86 | 0,2648 | 0,0132 |
| S10- | Grünbach Sandl | Freistadt / Süd | 0,98 | 0,1750 | 0,0031 | 0,98 | 0,1750 | 0,0048 | 1,37 | 0,2451 | 0,0070 | 1,37 | 0,2451 | 0,0111 | 1,96 | 0,2801 | 0,0089 | 1,97 | 0,2801 | 0,0140 |
| S10- | Freistadt / Nord | Grünbach Sandl | 0,27 | 0,0481 | 0,0008 | 0,27 | 0,0481 | 0,0013 | 0,38 | 0,0673 | 0,0019 | 0,38 | 0,0673 | 0,0030 | 0,54 | 0,0769 | 0,0024 | 0,54 | 0,0769 | 0,0038 |
| S16- | Landeck West | Zams | 1,14 | 0,2046 | 0,0036 | 1,14 | 0,2046 | 0,0056 | 1,60 | 0,2864 | 0,0082 | 1,60 | 0,2864 | 0,0129 | 2,29 | 0,3274 | 0,0104 | 2,30 | 0,3274 | 0,0163 |
| S16- | Pians | Landeck West | 0,73 | 0,1310 | 0,0023 | 0,73 | 0,1310 | 0,0036 | 1,02 | 0,1835 | 0,0053 | 1,03 | 0,1835 | 0,0083 | 1,47 | 0,2097 | 0,0067 | 1,47 | 0,2097 | 0,0105 |
| S16- | Flirsch | Pians | 1,45 | 0,2597 | 0,0045 | 1,45 | 0,2597 | 0,0071 | 2,03 | 0,3636 | 0,0105 | 2,04 | 0,3636 | 0,0164 | 2,91 | 0,4156 | 0,0132 | 2,92 | 0,4156 | 0,0207 |
| S16- | Schnann am Arlberg | Flirsch | 0,91 | 0,1630 | 0,0029 | 0,91 | 0,1630 | 0,0045 | 1,27 | 0,2283 | 0,0066 | 1,28 | 0,2283 | 0,0103 | 1,83 | 0,2609 | 0,0083 | 1,83 | 0,2609 | 0,0130 |
| S16- | Pettneu | Schnann am Arlberg | 0,66 | 0,1185 | 0,0021 | 0,66 | 0,1185 | 0,0033 | 0,93 | 0,1659 | 0,0048 | 0,93 | 0,1659 | 0,0075 | 1,33 | 0,1896 | 0,0060 | 1,33 | 0,1896 | 0,0095 |
| S16- | St. Anton/Arlberg | Pettneu | 0,37 | 0,0660 | 0,0012 | 0,37 | 0,0660 | 0,0018 | 0,52 | 0,0924 | 0,0027 | 0,52 | 0,0924 | 0,0042 | 0,74 | 0,1056 | 0,0033 | 0,74 | 0,1056 | 0,0053 |
| S16- | Langen/Arlberg | St. Anton/Arlberg | 8,43 | 0,6421 | 0,0112 | 8,43 | 0,6421 | 0,0177 | 11,81 | 0,8990 | 0,0258 | 11,82 | 0,8990 | 0,0406 | 17,39 | 1,0274 | 0,0326 | 17,41 | 1,0274 | 0,0512 |
| S16- | Wald/Arlberg | Langen/Arlberg | 1,17 | 0,2103 | 0,0037 | 1,17 | 0,2103 | 0,0058 | 1,64 | 0,2944 | 0,0085 | 1,65 | 0,2944 | 0,0133 | 2,36 | 0,3365 | 0,0107 | 2,37 | 0,3365 | 0,0168 |
| S16- | Dalaas | Wald/Arlberg | 1,34 | 0,2396 | 0,0042 | 1,34 | 0,2396 | 0,0066 | 1,87 | 0,3354 | 0,0096 | 1,88 | 0,3354 | 0,0152 | 2,69 | 0,3833 | 0,0122 | 2,69 | 0,3833 | 0,0191 |
| S16- | Braz Ost | Dalaas | 0,76 | 0,1358 | 0,0024 | 0,76 | 0,1358 | 0,0037 | 1,06 | 0,1901 | 0,0055 | 1,06 | 0,1901 | 0,0086 | 1,52 | 0,2173 | 0,0069 | 1,53 | 0,2173 | 0,0108 |
| S16- | Braz West | Braz Ost | 0,59 | 0,1060 | 0,0019 | 0,59 | 0,1060 | 0,0029 | 0,83 | 0,1483 | 0,0043 | 0,83 | 0,1483 | 0,0067 | 1,19 | 0,1695 | 0,0054 | 1,19 | 0,1695 | 0,0085 |
| S16- | Bings | Braz West | 0,80 | 0,1436 | 0,0025 | 0,80 | 0,1436 | 0,0039 | 1,12 | 0,2010 | 0,0058 | 1,13 | 0,2010 | 0,0091 | 1,61 | 0,2297 | 0,0073 | 1,61 | 0,2297 | 0,0114 |
| S16- | Bludenz Montafon | Bings | 0,38 | 0,0680 | 0,0012 | 0,38 | 0,0680 | 0,0019 | 0,53 | 0,0951 | 0,0027 | 0,53 | 0,0951 | 0,0043 | 0,76 | 0,1087 | 0,0034 | 0,76 | 0,1087 | 0,0054 |
| S31- | Eisenstadt Süd | Eisenstadt Ost | 0,69 | 0,1232 | 0,0022 | 0,69 | 0,1232 | 0,0034 | 0,96 | 0,1724 | 0,0050 | 0,97 | 0,1724 | 0,0078 | 1,38 | 0,1971 | 0,0063 | 1,39 | 0,1971 | 0,0098 |
| S31- | Eisenstadt Mitte | Eisenstadt Süd | 0,26 | 0,0461 | 0,0008 | 0,26 | 0,0461 | 0,0013 | 0,36 | 0,0646 | 0,0019 | 0,36 | 0,0646 | 0,0029 | 0,52 | 0,0738 | 0,0023 | 0,52 | 0,0738 | 0,0037 |
| S31- | KN Eisenstadt | Eisenstadt Mitte | 0,42 | 0,0761 | 0,0013 | 0,42 | 0,0761 | 0,0021 | 0,59 | 0,1065 | 0,0031 | 0,60 | 0,1065 | 0,0048 | 0,85 | 0,1217 | 0,0039 | 0,86 | 0,1217 | 0,0061 |
| S31- | Wulkaprodersdorf | KN Eisenstadt | 0,56 | 0,1013 | 0,0018 | 0,57 | 0,1013 | 0,0028 | 0,79 | 0,1418 | 0,0041 | 0,79 | 0,1418 | 0,0064 | 1,14 | 0,1620 | 0,0051 | 1,14 | 0,1620 | 0,0081 |
| S31- | KN Mattersburg | Wulkaprodersdorf | 1,60 | 0,2875 | 0,0050 | 1,61 | 0,2875 | 0,0079 | 2,25 | 0,4025 | 0,0116 | 2,25 | 0,4025 | 0,0182 | 3,22 | 0,4600 | 0,0146 | 3,23 | 0,4600 | 0,0229 |
| S31- | Forchtenstein | KN Mattersburg | 1,16 | 0,2081 | 0,0036 | 1,16 | 0,2081 | 0,0057 | 1,63 | 0,2914 | 0,0084 | 1,63 | 0,2914 | 0,0132 | 2,33 | 0,3330 | 0,0106 | 2,34 | 0,3330 | 0,0166 |
| S31- | Sieggraben | Forchtenstein | 1,62 | 0,2908 | 0,0051 | 1,62 | 0,2908 | 0,0080 | 2,27 | 0,4071 | 0,0117 | 2,28 | 0,4071 | 0,0184 | 3,26 | 0,4653 | 0,0148 | 3,27 | 0,4653 | 0,0232 |
| S31- | Weppersdorf/Kobersdorf | Sieggraben | 1,95 | 0,3503 | 0,0061 | 1,96 | 0,3503 | 0,0096 | 2,74 | 0,4904 | 0,0141 | 2,75 | 0,4904 | 0,0222 | 3,93 | 0,5605 | 0,0178 | 3,94 | 0,5605 | 0,0279 |
| S31- | Weppersdorf/Markt St.Martin | Weppersdorf/Kobersdorf | 0,40 | 0,0720 | 0,0013 | 0,40 | 0,0720 | 0,0020 | 0,56 | 0,1007 | 0,0029 | 0,56 | 0,1007 | 0,0046 | 0,81 | 0,1151 | 0,0037 | 0,81 | 0,1151 | 0,0057 |
| S31- | Neutal | Weppersdorf/Markt St.Martin | 0,93 | 0,1663 | 0,0029 | 0,93 | 0,1663 | 0,0046 | 1,30 | 0,2328 | 0,0067 | 1,30 | 0,2328 | 0,0105 | 1,87 | 0,2660 | 0,0084 | 1,87 | 0,2660 | 0,0133 |
| S31- | Stoob Süd | Neutal | 0,81 | 0,1453 | 0,0025 | 0,81 | 0,1453 | 0,0040 | 1,14 | 0,2034 | 0,0058 | 1,14 | 0,2034 | 0,0092 | 1,63 | 0,2324 | 0,0074 | 1,63 | 0,2324 | 0,0116 |
| S31- | Oberpullendorf | Stoob Süd | 0,88 | 0,1586 | 0,0028 | 0,89 | 0,1586 | 0,0044 | 1,24 | 0,2220 | 0,0064 | 1,24 | 0,2220 | 0,0100 | 1,78 | 0,2538 | 0,0080 | 1,78 | 0,2538 | 0,0126 |
| S33- | St. Pölten Ost | KN St. Pölten | 0,48 | 0,0861 | 0,0015 | 0,48 | 0,0861 | 0,0024 | 0,67 | 0,1205 | 0,0035 | 0,67 | 0,1205 | 0,0054 | 0,97 | 0,1377 | 0,0044 | 0,97 | 0,1377 | 0,0069 |
| S33- | St. Pölten Nord | St. Pölten Ost | 0,85 | 0,1521 | 0,0027 | 0,85 | 0,1521 | 0,0042 | 1,19 | 0,2130 | 0,0061 | 1,19 | 0,2130 | 0,0096 | 1,71 | 0,2434 | 0,0077 | 1,71 | 0,2434 | 0,0121 |
| S33- | Herzogenburg Süd | St. Pölten Nord | 0,90 | 0,1611 | 0,0028 | 0,90 | 0,1611 | 0,0044 | 1,26 | 0,2255 | 0,0065 | 1,26 | 0,2255 | 0,0102 | 1,81 | 0,2577 | 0,0082 | 1,81 | 0,2577 | 0,0128 |
| S33- | Herzogenburg Stadt | Herzogenburg Süd | 0,48 | 0,0860 | 0,0015 | 0,48 | 0,0860 | 0,0024 | 0,67 | 0,1204 | 0,0035 | 0,67 | 0,1204 | 0,0054 | 0,96 | 0,1376 | 0,0044 | 0,97 | 0,1376 | 0,0069 |
| S33- | Herzogenburg Nord | Herzogenburg Stadt | 0,27 | 0,0477 | 0,0008 | 0,27 | 0,0477 | 0,0013 | 0,37 | 0,0668 | 0,0019 | 0,37 | 0,0668 | 0,0030 | 0,53 | 0,0763 | 0,0024 | 0,54 | 0,0763 | 0,0038 |
| S33- | Traismauer Süd | Herzogenburg Nord | 1,29 | 0,2320 | 0,0041 | 1,30 | 0,2320 | 0,0064 | 1, | | | | | | | | | | | |

| | | | | | | | | | | | | | | | | | | | | |
|------|--------------------------|--------------------------|------|--------|--------|------|--------|--------|------|--------|--------|------|--------|--------|------|--------|--------|------|--------|--------|
| S36- | Zeltweg Ost Spielberg | Knittelfeld West | 0,21 | 0,0370 | 0,0006 | 0,21 | 0,0370 | 0,0010 | 0,29 | 0,0518 | 0,0015 | 0,29 | 0,0518 | 0,0023 | 0,42 | 0,0592 | 0,0019 | 0,42 | 0,0592 | 0,0030 |
| S36- | Zeltweg West | Zeltweg Ost Spielberg | 1,34 | 0,2408 | 0,0042 | 1,34 | 0,2408 | 0,0066 | 1,88 | 0,3371 | 0,0097 | 1,89 | 0,3371 | 0,0152 | 2,70 | 0,3853 | 0,0122 | 2,71 | 0,3853 | 0,0192 |
| S36- | Judenburg Ost Fohnsdorf | Zeltweg West | 0,67 | 0,1211 | 0,0021 | 0,68 | 0,1211 | 0,0033 | 0,95 | 0,1695 | 0,0049 | 0,95 | 0,1695 | 0,0077 | 1,36 | 0,1937 | 0,0061 | 1,36 | 0,1937 | 0,0097 |
| S36- | Judenburg West | Judenburg Ost Fohnsdorf | 1,05 | 0,1878 | 0,0033 | 1,05 | 0,1878 | 0,0052 | 1,47 | 0,2630 | 0,0076 | 1,47 | 0,2630 | 0,0119 | 2,11 | 0,3005 | 0,0095 | 2,11 | 0,3005 | 0,0150 |
| S36- | St. Georgen Ost | As B317 (prov.) | 0,11 | 0,0196 | 0,0003 | 0,11 | 0,0196 | 0,0005 | 0,15 | 0,0275 | 0,0008 | 0,15 | 0,0275 | 0,0012 | 0,22 | 0,0314 | 0,0010 | 0,22 | 0,0314 | 0,0016 |
| S36- | St. Georgen West | St. Georgen Ost | 0,20 | 0,0364 | 0,0006 | 0,20 | 0,0364 | 0,0010 | 0,28 | 0,0509 | 0,0015 | 0,29 | 0,0509 | 0,0023 | 0,41 | 0,0582 | 0,0018 | 0,41 | 0,0582 | 0,0029 |
| S37- | St. Veit Mitte / Brückl | St. Veit Nord | 0,63 | 0,1139 | 0,0020 | 0,64 | 0,1139 | 0,0031 | 0,89 | 0,1595 | 0,0046 | 0,89 | 0,1595 | 0,0072 | 1,28 | 0,1823 | 0,0058 | 1,28 | 0,1823 | 0,0091 |
| S37- | St. Veit Süd | St. Veit Mitte / Brückl | 0,54 | 0,0968 | 0,0017 | 0,54 | 0,0968 | 0,0027 | 0,76 | 0,1356 | 0,0039 | 0,76 | 0,1356 | 0,0061 | 1,09 | 0,1549 | 0,0049 | 1,09 | 0,1549 | 0,0077 |
| S37- | St. Veit Industriegebiet | St. Veit Süd | 0,41 | 0,0728 | 0,0013 | 0,41 | 0,0728 | 0,0020 | 0,57 | 0,1019 | 0,0029 | 0,57 | 0,1019 | 0,0046 | 0,82 | 0,1165 | 0,0037 | 0,82 | 0,1165 | 0,0058 |
| S37- | Maria Saal | St. Veit Industriegebiet | 1,42 | 0,2555 | 0,0045 | 1,43 | 0,2555 | 0,0070 | 2,00 | 0,3577 | 0,0103 | 2,00 | 0,3577 | 0,0162 | 2,87 | 0,4088 | 0,0130 | 2,87 | 0,4088 | 0,0204 |
| S37- | Karnburg | Maria Saal | 0,51 | 0,0912 | 0,0016 | 0,51 | 0,0912 | 0,0025 | 0,71 | 0,1277 | 0,0037 | 0,72 | 0,1277 | 0,0058 | 1,02 | 0,1460 | 0,0046 | 1,03 | 0,1460 | 0,0073 |
| S37- | Klagenfurt Nord | Karnburg | 0,44 | 0,0796 | 0,0014 | 0,44 | 0,0796 | 0,0022 | 0,62 | 0,1115 | 0,0032 | 0,62 | 0,1115 | 0,0050 | 0,89 | 0,1274 | 0,0040 | 0,90 | 0,1274 | 0,0064 |

| Road | Toll road section from | Toll road section to | EURO I Cat 2 | | | | | | EURO I Cat 3 | | | | | | EURO I Cat 4 | | | | | |
|------|----------------------------|----------------------------|--------------|--------|--------|-------|--------|--------|--------------|--------|--------|-------|--------|--------|--------------|--------|--------|-------|--------|--------|
| | | | Unit Price | | | | | | Unit Price | | | | | | Unit Price | | | | | |
| | | | Day | | | Night | | | Day | | | Night | | | Day | | | Night | | |
| | | | Sum | Air | Noise | Sum | Air | Noise | Sum | Air | Noise | Sum | Air | Noise | Sum | Air | Noise | Sum | Air | Noise |
| A01- | Wien Auhof | Preßbaum | 3,11 | 0,5572 | 0,0098 | 3,11 | 0,5572 | 0,0153 | 4,36 | 0,7801 | 0,0224 | 4,37 | 0,7801 | 0,0352 | 6,25 | 0,8915 | 0,0283 | 6,27 | 0,8915 | 0,0444 |
| A01- | Preßbaum | KN Steinhäusl | 1,75 | 0,3149 | 0,0055 | 1,76 | 0,3149 | 0,0087 | 2,46 | 0,4408 | 0,0127 | 2,47 | 0,4408 | 0,0199 | 3,53 | 0,5038 | 0,0160 | 3,54 | 0,5038 | 0,0251 |
| A01- | KN Steinhäusl | Altengbach | 1,03 | 0,1851 | 0,0032 | 1,03 | 0,1851 | 0,0051 | 1,45 | 0,2592 | 0,0075 | 1,45 | 0,2592 | 0,0117 | 2,08 | 0,2962 | 0,0094 | 2,08 | 0,2962 | 0,0148 |
| A01- | Altengbach | St. Christophen | 1,23 | 0,2208 | 0,0039 | 1,23 | 0,2208 | 0,0061 | 1,73 | 0,3091 | 0,0089 | 1,73 | 0,3091 | 0,0140 | 2,48 | 0,3532 | 0,0112 | 2,48 | 0,3532 | 0,0176 |
| A01- | St. Christophen | Böheimkirchen | 1,48 | 0,2648 | 0,0046 | 1,48 | 0,2648 | 0,0073 | 2,07 | 0,3707 | 0,0107 | 2,08 | 0,3707 | 0,0167 | 2,97 | 0,4236 | 0,0134 | 2,98 | 0,4236 | 0,0211 |
| A01- | Böheimkirchen | KN St. Pölten | 1,44 | 0,2590 | 0,0045 | 1,45 | 0,2590 | 0,0071 | 2,02 | 0,3626 | 0,0104 | 2,03 | 0,3626 | 0,0164 | 2,91 | 0,4144 | 0,0131 | 2,91 | 0,4144 | 0,0207 |
| A01- | KN St. Pölten | St. Pölten Süd | 1,02 | 0,1837 | 0,0032 | 1,03 | 0,1837 | 0,0051 | 1,44 | 0,2572 | 0,0074 | 1,44 | 0,2572 | 0,0116 | 2,06 | 0,2940 | 0,0093 | 2,07 | 0,2940 | 0,0147 |
| A01- | St. Pölten Süd | Loosdorf | 3,55 | 0,6371 | 0,0111 | 3,56 | 0,6371 | 0,0175 | 4,98 | 0,8920 | 0,0256 | 5,00 | 0,8920 | 0,0403 | 7,15 | 1,0194 | 0,0323 | 7,16 | 1,0194 | 0,0508 |
| A01- | Loosdorf | Melk | 1,30 | 0,2334 | 0,0041 | 1,30 | 0,2334 | 0,0064 | 1,82 | 0,3268 | 0,0094 | 1,83 | 0,3268 | 0,0148 | 2,62 | 0,3735 | 0,0118 | 2,63 | 0,3735 | 0,0186 |
| A01- | Melk | Pöchlarn | 2,31 | 0,4138 | 0,0072 | 2,31 | 0,4138 | 0,0114 | 3,24 | 0,5794 | 0,0167 | 3,24 | 0,5794 | 0,0262 | 4,64 | 0,6621 | 0,0210 | 4,65 | 0,6621 | 0,0330 |
| A01- | Pöchlarn | Ybbs Wieselburg | 2,13 | 0,3819 | 0,0067 | 2,13 | 0,3819 | 0,0105 | 2,99 | 0,5346 | 0,0154 | 2,99 | 0,5346 | 0,0242 | 4,28 | 0,6110 | 0,0194 | 4,29 | 0,6110 | 0,0305 |
| A01- | Ybbs Wieselburg | Amstetten Ost | 1,91 | 0,3432 | 0,0060 | 1,92 | 0,3432 | 0,0094 | 2,68 | 0,4804 | 0,0138 | 2,69 | 0,4804 | 0,0217 | 3,85 | 0,5491 | 0,0174 | 3,86 | 0,5491 | 0,0274 |
| A01- | Amstetten Ost | Amstetten West | 3,01 | 0,5398 | 0,0094 | 3,01 | 0,5398 | 0,0148 | 4,22 | 0,7557 | 0,0217 | 4,23 | 0,7557 | 0,0341 | 6,05 | 0,8636 | 0,0274 | 6,07 | 0,8636 | 0,0430 |
| A01- | Amstetten West | Oed | 2,11 | 0,3790 | 0,0066 | 2,12 | 0,3790 | 0,0104 | 2,96 | 0,5305 | 0,0153 | 2,97 | 0,5305 | 0,0240 | 4,25 | 0,6063 | 0,0192 | 4,26 | 0,6063 | 0,0302 |
| A01- | Oed | Haag | 2,28 | 0,4090 | 0,0072 | 2,28 | 0,4090 | 0,0112 | 3,20 | 0,5726 | 0,0165 | 3,21 | 0,5726 | 0,0259 | 4,59 | 0,6544 | 0,0208 | 4,60 | 0,6544 | 0,0326 |
| A01- | Haag | St. Valentin | 2,03 | 0,3642 | 0,0064 | 2,03 | 0,3642 | 0,0100 | 2,85 | 0,5099 | 0,0147 | 2,86 | 0,5099 | 0,0230 | 4,09 | 0,5827 | 0,0185 | 4,10 | 0,5827 | 0,0290 |
| A01- | St. Valentin | Enns Steyr | 0,86 | 0,1544 | 0,0027 | 0,86 | 0,1544 | 0,0042 | 1,21 | 0,2162 | 0,0062 | 1,21 | 0,2162 | 0,0098 | 1,73 | 0,2470 | 0,0078 | 1,74 | 0,2470 | 0,0123 |
| A01- | Enns Steyr | Enns West | 0,67 | 0,1198 | 0,0021 | 0,67 | 0,1198 | 0,0033 | 0,94 | 0,1677 | 0,0048 | 0,94 | 0,1677 | 0,0076 | 1,34 | 0,1916 | 0,0061 | 1,35 | 0,1916 | 0,0096 |
| A01- | Enns West | Asten St Florian | 0,52 | 0,0930 | 0,0016 | 0,52 | 0,0930 | 0,0026 | 0,73 | 0,1302 | 0,0037 | 0,73 | 0,1302 | 0,0059 | 1,04 | 0,1488 | 0,0047 | 1,05 | 0,1488 | 0,0074 |
| A01- | Asten St Florian | KN Linz | 1,98 | 0,3562 | 0,0098 | 1,99 | 0,3562 | 0,0098 | 2,78 | 0,4986 | 0,0143 | 2,79 | 0,4986 | 0,0225 | 3,99 | 0,5699 | 0,0181 | 4,01 | 0,5699 | 0,0284 |
| A01- | KN Linz | Ansfelden | 0,33 | 0,0600 | 0,0011 | 0,34 | 0,0600 | 0,0017 | 0,47 | 0,0841 | 0,0024 | 0,47 | 0,0841 | 0,0038 | 0,67 | 0,0961 | 0,0030 | 0,68 | 0,0961 | 0,0048 |
| A01- | Ansfelden | Traun | 0,74 | 0,1329 | 0,0023 | 0,74 | 0,1329 | 0,0037 | 1,04 | 0,1860 | 0,0053 | 1,04 | 0,1860 | 0,0084 | 1,49 | 0,2126 | 0,0067 | 1,49 | 0,2126 | 0,0106 |
| A01- | Traun | KN A1/A25 Passau Wels | 0,35 | 0,0625 | 0,0011 | 0,35 | 0,0625 | 0,0017 | 0,49 | 0,0875 | 0,0025 | 0,49 | 0,0875 | 0,0040 | 0,70 | 0,1000 | 0,0032 | 0,70 | 0,1000 | 0,0050 |
| A01- | KN A1/A25 Passau Wels | Allhaming | 1,61 | 0,2883 | 0,0050 | 1,61 | 0,2883 | 0,0079 | 2,25 | 0,4036 | 0,0116 | 2,26 | 0,4036 | 0,0182 | 3,23 | 0,4612 | 0,0146 | 3,24 | 0,4612 | 0,0230 |
| A01- | Allhaming | Sattledt | 2,68 | 0,4810 | 0,0084 | 2,69 | 0,4810 | 0,0132 | 3,76 | 0,6733 | 0,0194 | 3,77 | 0,6733 | 0,0304 | 5,39 | 0,7695 | 0,0244 | 5,41 | 0,7695 | 0,0384 |
| A01- | Sattledt | KN Voralpenkreuz | 0,34 | 0,0605 | 0,0011 | 0,34 | 0,0605 | 0,0017 | 0,47 | 0,0847 | 0,0024 | 0,47 | 0,0847 | 0,0038 | 0,68 | 0,0968 | 0,0031 | 0,68 | 0,0968 | 0,0048 |
| A01- | KN Voralpenkreuz | Eberstalzell | 0,97 | 0,1741 | 0,0030 | 0,97 | 0,1741 | 0,0048 | 1,36 | 0,2438 | 0,0070 | 1,37 | 0,2438 | 0,0110 | 1,95 | 0,2786 | 0,0088 | 1,96 | 0,2786 | 0,0139 |
| A01- | Eberstalzell | Vorchdorf | 1,46 | 0,2626 | 0,0046 | 1,47 | 0,2626 | 0,0072 | 2,05 | 0,3676 | 0,0106 | 2,06 | 0,3676 | 0,0166 | 2,94 | 0,4201 | 0,0133 | 2,95 | 0,4201 | 0,0209 |
| A01- | Vorchdorf | Laakirchen Ost | 1,28 | 0,2300 | 0,0040 | 1,28 | 0,2300 | 0,0063 | 1,80 | 0,3221 | 0,0093 | 1,80 | 0,3221 | 0,0146 | 2,58 | 0,3681 | 0,0117 | 2,59 | 0,3681 | 0,0183 |
| A01- | Laakirchen Ost | Laakirchen West | 0,81 | 0,1448 | 0,0025 | 0,81 | 0,1448 | 0,0040 | 1,13 | 0,2027 | 0,0058 | 1,14 | 0,2027 | 0,0092 | 1,62 | 0,2317 | 0,0073 | 1,63 | 0,2317 | 0,0115 |
| A01- | Laakirchen West | Regau | 1,58 | 0,2838 | 0,0050 | 1,58 | 0,2838 | 0,0078 | 2,22 | 0,3974 | 0,0114 | 2,23 | 0,3974 | 0,0180 | 3,18 | 0,4541 | 0,0144 | 3,19 | 0,4541 | 0,0226 |
| A01- | Regau | Schörfling | 2,08 | 0,3730 | 0,0065 | 2,08 | 0,3730 | 0,0103 | 2,92 | 0,5221 | 0,0150 | 2,92 | 0,5221 | 0,0236 | 4,18 | 0,5967 | 0,0189 | 4,19 | 0,5967 | 0,0297 |
| A01- | Schörfling | Seewalchen | 0,32 | 0,0578 | 0,0010 | 0,32 | 0,0578 | 0,0016 | 0,45 | 0,0809 | 0,0023 | 0,45 | 0,0809 | 0,0037 | 0,65 | 0,0925 | 0,0029 | 0,65 | 0,0925 | 0,0046 |
| A01- | Seewalchen | St. Georgen | 1,88 | 0,3381 | 0,0059 | 1,89 | 0,3381 | 0,0093 | 2,64 | 0,4733 | 0,0136 | 2,65 | 0,4733 | 0,0214 | 3,79 | 0,5409 | 0,0172 | 3,80 | 0,5409 | 0,0270 |
| A01- | St. Georgen | Oberwang | 2,51 | 0,4508 | 0,0079 | 2,52 | 0,4508 | 0,0124 | 3,52 | 0,6311 | 0,0181 | 3,53 | 0,6311 | 0,0285 | 5,06 | 0,7213 | 0,0229 | 5,07 | 0,7213 | 0,0360 |
| A01- | Oberwang | Mondsee | 2,31 | 0,4149 | 0,0073 | 2,32 | 0,4149 | 0,0114 | 3,24 | 0,5809 | 0,0167 | 3,25 | 0,5809 | 0,0262 | 4,65 | 0,6639 | 0,0211 | 4,67 | 0,6639 | 0,0331 |
| A01- | Mondsee | Thalgau | 2,13 | 0,3825 | 0,0067 | 2,14 | 0,3825 | 0,0105 | 2,99 | 0,5355 | 0,0154 | 3,00 | 0,5355 | 0,0242 | 4,29 | 0,6120 | 0,0194 | 4,30 | 0,6120 | 0,0305 |
| A01- | Thalgau | Wallersee | 1,62 | 0,2915 | 0,0051 | 1,63 | 0,2915 | 0,0080 | 2,28 | 0,4081 | 0,0117 | 2,29 | 0,4081 | 0,0184 | 3,27 | 0,4664 | 0,0148 | 3,28 | 0,4664 | 0,0232 |
| A01- | Wallersee | Salzburg Nord | 1,57 | 0,2822 | 0,0049 | 1,58 | 0,2822 | 0,0078 | 2,21 | 0,3950 | 0,0114 | 2,21 | 0,3950 | 0,0178 | 3,16 | 0,4515 | 0,0143 | 3,17 | 0,4515 | 0,0225 |
| A01- | Salzburg Nord | Salzburg Bergheim-West | 0,35 | 0,0636 | 0,0011 | 0,36 | 0,0636 | 0,0017 | 0,50 | 0,0890 | 0,0026 | 0,50 | 0,0890 | 0,0040 | 0,71 | 0,1018 | 0,0032 | 0,72 | 0,1018 | 0,0051 |
| A01- | Salzburg Bergheim-West | Messe | 0,17 | 0,0304 | 0,0005 | 0,17 | 0,0304 | 0,0008 | 0,24 | 0,0426 | 0,0012 | 0,24 | 0,0426 | 0,0019 | 0,34 | 0,0487 | 0,0015 | 0,34 | 0,0487 | 0,0024 |
| A01- | Messe | Salzburg Mitte Freilassing | 0,23 | 0,0405 | 0,0007 | 0,23 | 0,0405 | 0,0011 | 0,32 | 0,0567 | 0,0016 | 0,32 | 0,0567 | 0,0026 | 0,45 | 0,0648 | 0,0021 | 0,46 | 0,0648 | 0,0032 |
| A01- | Salzburg Mitte Freilassing | Kleßheim | 0,28 | 0,0497 | 0,0009 | 0,28 | 0,0497 | 0,0014 | 0,39 | 0,0696 | 0,0020 | 0,39 | 0,0696 | 0,0031 | 0,56 | 0,0796 | 0,0025 | 0,56 | 0,0796 | 0,0040 |
| A01- | Kleßheim | Siezenheim | 0,38 | 0,0689 | 0,0012 | 0,38 | 0,0689 | 0,0019 | 0,54 | 0,0965 | 0,0028 | 0,54 | 0,0965 | 0,0044 | 0,77 | 0,1103 | 0,0035 | 0,78 | 0,1103 | 0,0055 |
| A01- | Siezenheim | Flughafen | 0,19 | 0,0346 | 0,0006 | 0,19 | 0,0346 | 0,0010 | 0,27 | 0,0485 | 0,0014 | 0,27 | 0,0485 | 0,0022 | 0,39 | 0,0554 | 0,0018 | 0,39 | 0,0554 | 0,0028 |
| A01- | Flughafen | Wals Salzburg West | 0,24 | 0,0424 | 0,0007 | 0,24 | 0,0424 | 0,0012 | 0,33 | 0,0593 | 0,0017 | 0,33 | 0,0593 | 0,0027 | 0,48 | 0,0678 | 0,0021 | 0,48 | 0,0678 | 0,0034 |
| A01- | Wals Salzburg West | KN Salzburg | 0,35 | 0,0634 | 0,0011 | 0,35 | 0,0634 | 0,0017 | 0,50 | 0,0888 | 0,0026 | 0,50 | 0,0888 | 0,0040 | 0,71 | 0,1014 | 0,0032 | 0,71 | 0,1014 | 0,0051 |
| A01- | KN Salzburg | Staatsgrenze Walsberg | 0,60 | 0,1077 | 0,0019 | 0,60 | 0,1077 | 0,0030 | 0,84 | 0,1508 | 0,0043 | 0,84 | 0,1508 | 0,0068 | 1,21 | 0,1724 | 0,0055 | 1,21 | 0,1724 | 0,0086 |
| A02- | KN Wien Inzersdorf | KN Vösendorf | 0,75 | 0,1348 | 0,0024 | 0,75 | 0,1348 | 0,0037 | 1,05 | 0,1887 | 0,0054 | 1,06 | 0,1887 | 0,0085 | 1,51 | 0,2157 | 0,0068 | 1,52 | 0,2157 | 0,0108 |
| A02- | KN Vösendorf | Mödling | 0,51 | 0,0916 | 0,0016 | 0,51 | 0,0916 | 0,0025 | 0,72 | 0,1283 | 0,0037 | 0,72 | 0,1283 | 0,0058 | 1,03 | 0,1466 | 0,0047 | 1,03 | 0,1466 | 0,0073 |
| A02- | Mödling | Wr. Neudorf | 0,49 | 0,0874 | 0,0015 | 0,49 | 0,0874 | 0,0024 | 0,68 | 0,1224 | 0,0035 | 0,69 | 0,1224 | 0,0055 | 0,98 | 0,1399 | 0,0044 | 0,98 | 0,1399 | 0,0070 |
| A02- | Wr. Neudorf | Wr. Neudorf IZ/Süd | 0,54 | 0,0962 | 0,0017 | 0,54 | 0,0962 | 0,0026 | 0,75 | 0,1347 | 0,0039 | 0,75 | 0,1347 | 0,0061 | 1,08 | 0,1539 | 0,0049 | 1,08 | 0,1539 | 0,0077 |
| A02- | Wr. Neudorf IZ/Süd | KN Guntramsdorf | 0,78 | 0,1402 | 0,0025 | 0,78 | 0,1402 | 0,0039 | 1,10 | 0,1963 | 0,0056 | 1,10 | 0,1963 | 0,0089 | 1,57 | 0,2244 | 0,0071 | 1,58 | 0,2244 | 0,0112 |
| A02- | KN Guntramsdorf | Traiskirchen | 0,87 | 0,1562 | 0,0027 | 0,87 | 0,1562 | 0,0043 | 1,22 | 0,2186 | 0,0063 | 1,22 | 0,2186 | 0,0099 | 1,75 | 0,2499 | 0,0079 | 1,76 | 0,2499 | 0,0125 |
| A02- | Traiskirchen | Baden | 0,48 | 0,0869 | 0,0015 | 0,49 | 0,0869 | 0 | | | | | | | | | | | | |

| | | | | | | | | | | | | | | | | | | | | |
|------|----------------------------|---------------------------------------|------|--------|--------|------|--------|--------|------|--------|--------|------|--------|--------|------|--------|--------|------|--------|--------|
| A02- | Ilz Fürstenfeld | Sinabelkirchen | 2,50 | 0,4493 | 0,0079 | 2,51 | 0,4493 | 0,0124 | 3,51 | 0,6290 | 0,0181 | 3,52 | 0,6290 | 0,0284 | 5,04 | 0,7189 | 0,0228 | 5,05 | 0,7189 | 0,0358 |
| A02- | Sinabelkirchen | Gleisdorf Süd | 1,65 | 0,2960 | 0,0052 | 1,65 | 0,2960 | 0,0081 | 2,31 | 0,4144 | 0,0119 | 2,32 | 0,4144 | 0,0187 | 3,32 | 0,4736 | 0,0150 | 3,33 | 0,4736 | 0,0236 |
| A02- | Gleisdorf Süd | Gleisdorf West | 0,72 | 0,1285 | 0,0022 | 0,72 | 0,1285 | 0,0035 | 1,00 | 0,1799 | 0,0052 | 1,01 | 0,1799 | 0,0081 | 1,44 | 0,2056 | 0,0065 | 1,44 | 0,2056 | 0,0102 |
| A02- | Gleisdorf West | Laßnitzhöhe | 1,88 | 0,3366 | 0,0059 | 1,88 | 0,3366 | 0,0093 | 2,63 | 0,4713 | 0,0135 | 2,64 | 0,4713 | 0,0213 | 3,78 | 0,5386 | 0,0171 | 3,79 | 0,5386 | 0,0268 |
| A02- | Laßnitzhöhe | KN Graz Ost | 2,35 | 0,4212 | 0,0074 | 2,35 | 0,4212 | 0,0116 | 3,29 | 0,5896 | 0,0170 | 3,30 | 0,5896 | 0,0266 | 4,72 | 0,6739 | 0,0214 | 4,74 | 0,6739 | 0,0336 |
| A02- | KN Graz Ost | Graz Feldkirchen Flughafen | 0,84 | 0,1515 | 0,0027 | 0,85 | 0,1515 | 0,0042 | 1,18 | 0,2121 | 0,0061 | 1,19 | 0,2121 | 0,0096 | 1,70 | 0,2424 | 0,0077 | 1,70 | 0,2424 | 0,0121 |
| A02- | Graz Feldkirchen Flughafen | KN Graz West | 0,57 | 0,1014 | 0,0018 | 0,57 | 0,1014 | 0,0028 | 0,79 | 0,1420 | 0,0041 | 0,80 | 0,1420 | 0,0064 | 1,14 | 0,1623 | 0,0051 | 1,14 | 0,1623 | 0,0081 |
| A02- | KN Graz West | Unterpremstätten | 0,68 | 0,1220 | 0,0021 | 0,68 | 0,1220 | 0,0034 | 0,95 | 0,1707 | 0,0049 | 0,96 | 0,1707 | 0,0077 | 1,37 | 0,1951 | 0,0062 | 1,37 | 0,1951 | 0,0097 |
| A02- | Unterpremstätten | Lieboch | 1,06 | 0,1894 | 0,0033 | 1,06 | 0,1894 | 0,0052 | 1,48 | 0,2652 | 0,0076 | 1,49 | 0,2652 | 0,0120 | 2,12 | 0,3030 | 0,0096 | 2,13 | 0,3030 | 0,0151 |
| A02- | Lieboch | Mooskirchen | 1,46 | 0,2612 | 0,0046 | 1,46 | 0,2612 | 0,0072 | 2,04 | 0,3656 | 0,0105 | 2,05 | 0,3656 | 0,0165 | 2,93 | 0,4179 | 0,0133 | 2,94 | 0,4179 | 0,0208 |
| A02- | Mooskirchen | Steinberg | 1,51 | 0,2703 | 0,0047 | 1,51 | 0,2703 | 0,0074 | 2,11 | 0,3784 | 0,0109 | 2,12 | 0,3784 | 0,0171 | 3,03 | 0,4324 | 0,0137 | 3,04 | 0,4324 | 0,0216 |
| A02- | Steinberg | Modriach | 3,76 | 0,6756 | 0,0118 | 3,77 | 0,6756 | 0,0186 | 5,28 | 0,9458 | 0,0272 | 5,30 | 0,9458 | 0,0427 | 7,58 | 1,0810 | 0,0343 | 7,60 | 1,0810 | 0,0539 |
| A022 | KN Graz Ost | Puchwerk | 0,16 | 0,0283 | 0,0005 | 0,16 | 0,0283 | 0,0008 | 0,22 | 0,0396 | 0,0011 | 0,22 | 0,0396 | 0,0018 | 0,32 | 0,0453 | 0,0014 | 0,32 | 0,0453 | 0,0023 |
| A022 | Puchwerk | Graz Raaba | 0,23 | 0,0405 | 0,0007 | 0,23 | 0,0405 | 0,0011 | 0,32 | 0,0567 | 0,0016 | 0,32 | 0,0567 | 0,0026 | 0,45 | 0,0648 | 0,0021 | 0,46 | 0,0648 | 0,0032 |
| A022 | Graz Raaba | Graz Sternäckerweg | 0,33 | 0,0588 | 0,0010 | 0,33 | 0,0588 | 0,0016 | 0,46 | 0,0824 | 0,0024 | 0,46 | 0,0824 | 0,0037 | 0,66 | 0,0941 | 0,0030 | 0,66 | 0,0941 | 0,0047 |
| A02- | Modriach | Packsattel | 1,73 | 0,3112 | 0,0054 | 1,74 | 0,3112 | 0,0086 | 2,43 | 0,4356 | 0,0125 | 2,44 | 0,4356 | 0,0197 | 3,49 | 0,4979 | 0,0158 | 3,50 | 0,4979 | 0,0248 |
| A02- | Packsattel | Bad St. Leonhard | 2,11 | 0,3784 | 0,0066 | 2,11 | 0,3784 | 0,0104 | 2,96 | 0,5297 | 0,0152 | 2,97 | 0,5297 | 0,0239 | 4,24 | 0,6054 | 0,0192 | 4,25 | 0,6054 | 0,0302 |
| A02- | Bad St. Leonhard | Wolfsberg Nord | 2,48 | 0,4446 | 0,0078 | 2,48 | 0,4446 | 0,0122 | 3,48 | 0,6225 | 0,0179 | 3,49 | 0,6225 | 0,0281 | 4,99 | 0,7114 | 0,0226 | 5,00 | 0,7114 | 0,0355 |
| A02- | Wolfsberg Nord | Wolfsberg Süd | 0,70 | 0,1264 | 0,0022 | 0,71 | 0,1264 | 0,0035 | 0,99 | 0,1770 | 0,0051 | 0,99 | 0,1770 | 0,0080 | 1,42 | 0,2022 | 0,0064 | 1,42 | 0,2022 | 0,0101 |
| A02- | Wolfsberg Süd | St. Andrä | 2,07 | 0,3714 | 0,0065 | 2,07 | 0,3714 | 0,0102 | 2,90 | 0,5200 | 0,0149 | 2,91 | 0,5200 | 0,0235 | 4,17 | 0,5942 | 0,0188 | 4,18 | 0,5942 | 0,0296 |
| A02- | St. Andrä | Griffen | 2,01 | 0,3610 | 0,0063 | 2,02 | 0,3610 | 0,0099 | 2,82 | 0,5054 | 0,0145 | 2,83 | 0,5054 | 0,0228 | 4,05 | 0,5776 | 0,0183 | 4,06 | 0,5776 | 0,0288 |
| A02- | Griffen | Völkermarkt Ost | 1,02 | 0,1824 | 0,0032 | 1,02 | 0,1824 | 0,0050 | 1,43 | 0,2553 | 0,0073 | 1,43 | 0,2553 | 0,0115 | 2,05 | 0,2918 | 0,0093 | 2,05 | 0,2918 | 0,0145 |
| A02- | Völkermarkt Ost | Völkermarkt West | 2,35 | 0,4208 | 0,0074 | 2,35 | 0,4208 | 0,0116 | 3,29 | 0,5892 | 0,0169 | 3,30 | 0,5892 | 0,0266 | 4,72 | 0,6733 | 0,0214 | 4,73 | 0,6733 | 0,0336 |
| A02- | Völkermarkt West | Grafenstein | 2,24 | 0,4028 | 0,0070 | 2,25 | 0,4028 | 0,0111 | 3,15 | 0,5640 | 0,0162 | 3,16 | 0,5640 | 0,0255 | 4,52 | 0,6445 | 0,0204 | 4,53 | 0,6445 | 0,0321 |
| A02- | Grafenstein | Klagenfurt Ost | 1,44 | 0,2584 | 0,0045 | 1,44 | 0,2584 | 0,0071 | 2,02 | 0,3618 | 0,0104 | 2,03 | 0,3618 | 0,0163 | 2,90 | 0,4134 | 0,0131 | 2,91 | 0,4134 | 0,0206 |
| A02- | Klagenfurt Ost | Klagenfurt Flughafen | 0,73 | 0,1307 | 0,0023 | 0,73 | 0,1307 | 0,0036 | 1,02 | 0,1830 | 0,0053 | 1,02 | 0,1830 | 0,0083 | 1,47 | 0,2092 | 0,0066 | 1,47 | 0,2092 | 0,0104 |
| A02- | Klagenfurt Flughafen | Klagenfurt Nord | 0,81 | 0,1448 | 0,0025 | 0,81 | 0,1448 | 0,0040 | 1,13 | 0,2027 | 0,0058 | 1,14 | 0,2027 | 0,0092 | 1,62 | 0,2317 | 0,0073 | 1,63 | 0,2317 | 0,0115 |
| A02- | Klagenfurt Nord | Klagenfurt West | 1,40 | 0,2504 | 0,0044 | 1,40 | 0,2504 | 0,0069 | 1,96 | 0,3505 | 0,0101 | 1,96 | 0,3505 | 0,0158 | 2,81 | 0,4006 | 0,0127 | 2,82 | 0,4006 | 0,0200 |
| A02- | Klagenfurt West | Kruppendorf West | 0,56 | 0,0998 | 0,0017 | 0,56 | 0,0998 | 0,0027 | 0,78 | 0,1397 | 0,0040 | 0,78 | 0,1397 | 0,0063 | 1,12 | 0,1597 | 0,0051 | 1,12 | 0,1597 | 0,0080 |
| A02- | Kruppendorf West | Pörschach Ost | 0,67 | 0,1202 | 0,0021 | 0,67 | 0,1202 | 0,0033 | 0,94 | 0,1683 | 0,0048 | 0,94 | 0,1683 | 0,0076 | 1,35 | 0,1923 | 0,0061 | 1,35 | 0,1923 | 0,0096 |
| A02- | Pörschach Ost | Pörschach West | 1,04 | 0,1872 | 0,0033 | 1,04 | 0,1872 | 0,0051 | 1,46 | 0,2620 | 0,0075 | 1,47 | 0,2620 | 0,0118 | 2,10 | 0,2995 | 0,0095 | 2,10 | 0,2995 | 0,0149 |
| A02- | Pörschach West | Velden Ost | 0,77 | 0,1387 | 0,0024 | 0,77 | 0,1387 | 0,0038 | 1,08 | 0,1942 | 0,0056 | 1,09 | 0,1942 | 0,0088 | 1,56 | 0,2219 | 0,0070 | 1,56 | 0,2219 | 0,0111 |
| A02- | Velden Ost | Velden West | 0,83 | 0,1493 | 0,0026 | 0,83 | 0,1493 | 0,0041 | 1,17 | 0,2090 | 0,0060 | 1,17 | 0,2090 | 0,0094 | 1,67 | 0,2389 | 0,0076 | 1,68 | 0,2389 | 0,0119 |
| A02- | Velden West | Wernberg | 1,38 | 0,2468 | 0,0043 | 1,38 | 0,2468 | 0,0068 | 1,93 | 0,3455 | 0,0099 | 1,93 | 0,3455 | 0,0156 | 2,77 | 0,3949 | 0,0125 | 2,78 | 0,3949 | 0,0197 |
| A02- | Wernberg | KN Villach | 0,73 | 0,1312 | 0,0023 | 0,73 | 0,1312 | 0,0036 | 1,03 | 0,1837 | 0,0053 | 1,03 | 0,1837 | 0,0083 | 1,47 | 0,2099 | 0,0067 | 1,48 | 0,2099 | 0,0105 |
| A02- | KN Villach | Villach Faaker See | 0,57 | 0,1020 | 0,0018 | 0,57 | 0,1020 | 0,0028 | 0,80 | 0,1428 | 0,0041 | 0,80 | 0,1428 | 0,0065 | 1,14 | 0,1632 | 0,0052 | 1,15 | 0,1632 | 0,0081 |
| A02- | Villach Faaker See | Villach Warmbad | 1,30 | 0,2330 | 0,0041 | 1,30 | 0,2330 | 0,0064 | 1,82 | 0,3262 | 0,0094 | 1,83 | 0,3262 | 0,0147 | 2,61 | 0,3728 | 0,0118 | 2,62 | 0,3728 | 0,0186 |
| A02- | Villach Warmbad | Hermagor | 2,35 | 0,4224 | 0,0074 | 2,36 | 0,4224 | 0,0116 | 3,30 | 0,5914 | 0,0170 | 3,31 | 0,5914 | 0,0267 | 4,74 | 0,6758 | 0,0214 | 4,75 | 0,6758 | 0,0337 |
| A02- | Hermagor | Arnoldstein | 0,56 | 0,1006 | 0,0018 | 0,56 | 0,1006 | 0,0028 | 0,79 | 0,1408 | 0,0040 | 0,79 | 0,1408 | 0,0064 | 1,13 | 0,1610 | 0,0051 | 1,13 | 0,1610 | 0,0080 |
| A02- | Arnoldstein | Staatsgrenze Arnoldstein | 0,86 | 0,1542 | 0,0027 | 0,86 | 0,1542 | 0,0042 | 1,21 | 0,2159 | 0,0062 | 1,21 | 0,2159 | 0,0098 | 1,73 | 0,2468 | 0,0078 | 1,73 | 0,2468 | 0,0123 |
| A03- | KN Guntramsdorf | Münchendorf/Achau | 0,22 | 0,0400 | 0,0007 | 0,22 | 0,0400 | 0,0011 | 0,31 | 0,0561 | 0,0016 | 0,31 | 0,0561 | 0,0025 | 0,45 | 0,0641 | 0,0020 | 0,45 | 0,0641 | 0,0032 |
| A03- | Münchendorf/Achau | Ebreichsdorf Nord | 0,94 | 0,1686 | 0,0029 | 0,94 | 0,1686 | 0,0046 | 1,32 | 0,2360 | 0,0068 | 1,32 | 0,2360 | 0,0107 | 1,89 | 0,2697 | 0,0086 | 1,90 | 0,2697 | 0,0134 |
| A03- | Ebreichsdorf Nord | Ebreichsdorf West | 0,77 | 0,1376 | 0,0024 | 0,77 | 0,1376 | 0,0038 | 1,08 | 0,1926 | 0,0055 | 1,08 | 0,1926 | 0,0087 | 1,54 | 0,2202 | 0,0070 | 1,55 | 0,2202 | 0,0110 |
| A03- | Ebreichsdorf West | Pottendorf | 1,01 | 0,1805 | 0,0032 | 1,01 | 0,1805 | 0,0050 | 1,41 | 0,2527 | 0,0073 | 1,42 | 0,2527 | 0,0114 | 2,02 | 0,2888 | 0,0092 | 2,03 | 0,2888 | 0,0144 |
| A03- | Pottendorf | Hornstein | 1,65 | 0,2964 | 0,0052 | 1,65 | 0,2964 | 0,0082 | 2,32 | 0,4150 | 0,0119 | 2,32 | 0,4150 | 0,0187 | 3,32 | 0,4742 | 0,0150 | 3,33 | 0,4742 | 0,0236 |
| A03- | Hornstein | Müllendorf | 1,08 | 0,1942 | 0,0034 | 1,08 | 0,1942 | 0,0053 | 1,52 | 0,2719 | 0,0078 | 1,52 | 0,2719 | 0,0123 | 2,18 | 0,3108 | 0,0099 | 2,18 | 0,3108 | 0,0155 |
| A03- | Müllendorf | KN Eisenstadt | 0,90 | 0,1624 | 0,0028 | 0,91 | 0,1624 | 0,0045 | 1,27 | 0,2273 | 0,0065 | 1,27 | 0,2273 | 0,0103 | 1,82 | 0,2598 | 0,0082 | 1,83 | 0,2598 | 0,0129 |
| A031 | KN Eisenstadt | Siegersdorf | 0,71 | 0,1280 | 0,0022 | 0,71 | 0,1280 | 0,0035 | 1,00 | 0,1792 | 0,0052 | 1,00 | 0,1792 | 0,0081 | 1,44 | 0,2048 | 0,0065 | 1,44 | 0,2048 | 0,0102 |
| A041 | Stadionbrücke | KN Wien Prater | 0,13 | 0,0235 | 0,0004 | 0,13 | 0,0235 | 0,0006 | 0,18 | 0,0329 | 0,0009 | 0,18 | 0,0329 | 0,0015 | 0,26 | 0,0376 | 0,0012 | 0,26 | 0,0376 | 0,0019 |
| A04- | KN Wien Prater | Alt-Simmering Wien 7. Haidequerstraße | 0,29 | 0,0512 | 0,0009 | 0,29 | 0,0512 | 0,0014 | 0,40 | 0,0717 | 0,0021 | 0,40 | 0,0717 | 0,0032 | 0,57 | 0,0820 | 0,0026 | 0,58 | 0,0820 | 0,0041 |
| A04- | Alt-Simmering | Wien 7. Haidequerstraße | 0,22 | 0,0387 | 0,0007 | 0,22 | 0,0387 | 0,0011 | 0,30 | 0,0542 | 0,0016 | 0,30 | 0,0542 | 0,0024 | 0,43 | 0,0619 | 0,0020 | 0,44 | 0,0619 | 0,0031 |
| A04- | Wien 7. Haidequerstraße | Wien Simmeringer Haide | 0,40 | 0,0723 | 0,0013 | 0,40 | 0,0723 | 0,0020 | 0,57 | 0,1012 | 0,0029 | 0,57 | 0,1012 | 0,0046 | 0,81 | 0,1156 | 0,0037 | 0,81 | 0,1156 | 0,0058 |
| A04- | Wien Simmeringer Haide | KN Schwechat | 0,81 | 0,1456 | 0,0025 | 0,81 | 0,1456 | 0,0040 | 1,14 | 0,2038 | 0,0059 | 1,14 | 0,2038 | 0,0092 | 1,63 | 0,2330 | 0,0074 | 1,64 | 0,2330 | 0,0116 |
| A04- | KN Schwechat | Flughafen Wien Schwechat | 1,17 | 0,2103 | 0,0037 | 1,17 | 0,2103 | 0,0058 | 1,64 | 0,2944 | 0,0085 | 1,65 | 0,2944 | 0,0133 | 2,36 | 0,3365 | 0,0107 | 2,37 | 0,3365 | 0,0168 |
| A04- | Flughafen Wien Schwechat | Fischamend | 1,31 | 0,2355 | 0,0041 | 1,31 | 0,2355 | 0,0065 | 1,84 | 0,3297 | 0,0095 | 1,85 | 0,3297 | 0,0149 | 2,64 | 0,3768 | 0,0120 | 2,65 | 0,3768 | 0,0188 |
| A04- | Fischamend | Bruck/Leitha West | 2,88 | 0,5164 | 0,0090 | 2,88 | 0,5164 | 0,0142 | 4,04 | 0,7230 | 0,0208 | 4,05 | 0,7230 | 0,0327 | 5,79 | 0,8263 | 0,0262 | 5,81 | 0,8263 | 0,0412 |
| A04- | Bruck/Leitha West | Bruck/Leitha Ost | 0,96 | 0,1715 | 0,0030 | 0,96 | 0,1715 | 0,0047 | 1,34 | 0,2401 | 0,006 | | | | | | | | | |

| | | | | | | | | | | | | | | | | | | | | |
|------|----------------------------------|----------------------------------|-------|--------|--------|-------|--------|--------|-------|--------|--------|-------|--------|--------|-------|--------|--------|-------|--------|--------|
| A05- | Großkrut | Poysdorf Nord | 1,53 | 0,2741 | 0,0048 | 1,53 | 0,2741 | 0,0075 | 2,14 | 0,3838 | 0,0110 | 2,15 | 0,3838 | 0,0173 | 3,07 | 0,4386 | 0,0139 | 3,08 | 0,4386 | 0,0219 |
| A06- | KN Bruckneudorf | Potzneusiedl | 1,94 | 0,3472 | 0,0061 | 1,94 | 0,3472 | 0,0095 | 2,71 | 0,4861 | 0,0140 | 2,72 | 0,4861 | 0,0220 | 3,89 | 0,5556 | 0,0176 | 3,90 | 0,5556 | 0,0277 |
| A06- | Potzneusiedl | Gattendorf | 0,84 | 0,1507 | 0,0026 | 0,84 | 0,1507 | 0,0041 | 1,18 | 0,2110 | 0,0061 | 1,18 | 0,2110 | 0,0095 | 1,69 | 0,2412 | 0,0076 | 1,69 | 0,2412 | 0,0120 |
| A06- | Gattendorf | Kittsee | 1,40 | 0,2521 | 0,0044 | 1,41 | 0,2521 | 0,0069 | 1,97 | 0,3529 | 0,0101 | 1,98 | 0,3529 | 0,0159 | 2,83 | 0,4033 | 0,0128 | 2,83 | 0,4033 | 0,0201 |
| A06- | Kittsee | Staatsgrenze Kittsee | 0,71 | 0,1280 | 0,0022 | 0,71 | 0,1280 | 0,0035 | 1,00 | 0,1793 | 0,0052 | 1,00 | 0,1793 | 0,0081 | 1,44 | 0,2049 | 0,0065 | 1,44 | 0,2049 | 0,0102 |
| A07- | KN Linz | Linz Franzosenhausweg | 0,50 | 0,0903 | 0,0016 | 0,50 | 0,0903 | 0,0025 | 0,71 | 0,1264 | 0,0036 | 0,71 | 0,1264 | 0,0057 | 1,01 | 0,1445 | 0,0046 | 1,02 | 0,1445 | 0,0072 |
| A07- | Linz Franzosenhausweg | Linz Salzburger Straße Neue Welt | 0,44 | 0,0788 | 0,0014 | 0,44 | 0,0788 | 0,0022 | 0,62 | 0,1104 | 0,0032 | 0,62 | 0,1104 | 0,0050 | 0,88 | 0,1261 | 0,0040 | 0,89 | 0,1261 | 0,0063 |
| A07- | Linz Salzburger Straße Neue Welt | Muldenstraße Bindermichl | 0,30 | 0,0547 | 0,0010 | 0,31 | 0,0547 | 0,0015 | 0,43 | 0,0766 | 0,0022 | 0,43 | 0,0766 | 0,0035 | 0,61 | 0,0876 | 0,0028 | 0,62 | 0,0876 | 0,0044 |
| A07- | Muldenstraße Bindermichl | Leonding Linz Zentrum | 0,15 | 0,0266 | 0,0005 | 0,15 | 0,0266 | 0,0007 | 0,21 | 0,0372 | 0,0011 | 0,21 | 0,0372 | 0,0017 | 0,30 | 0,0425 | 0,0013 | 0,30 | 0,0425 | 0,0021 |
| A07- | Leonding Linz Zentrum | Linz Wiener Straße | 0,21 | 0,0374 | 0,0007 | 0,21 | 0,0374 | 0,0010 | 0,29 | 0,0523 | 0,0015 | 0,29 | 0,0523 | 0,0024 | 0,42 | 0,0598 | 0,0019 | 0,42 | 0,0598 | 0,0030 |
| A07- | Linz Wiener Straße | Linz VOEST | 0,19 | 0,0347 | 0,0006 | 0,19 | 0,0347 | 0,0010 | 0,27 | 0,0486 | 0,0014 | 0,27 | 0,0486 | 0,0022 | 0,39 | 0,0556 | 0,0018 | 0,39 | 0,0556 | 0,0028 |
| A07- | Linz VOEST | Linz Industriezeile | 0,15 | 0,0272 | 0,0005 | 0,15 | 0,0272 | 0,0007 | 0,21 | 0,0381 | 0,0011 | 0,21 | 0,0381 | 0,0017 | 0,31 | 0,0436 | 0,0014 | 0,31 | 0,0436 | 0,0022 |
| A07- | Linz Industriezeile | Linz Prinz Eugenstraße | 0,24 | 0,0432 | 0,0008 | 0,24 | 0,0432 | 0,0012 | 0,34 | 0,0605 | 0,0017 | 0,34 | 0,0605 | 0,0027 | 0,49 | 0,0692 | 0,0022 | 0,49 | 0,0692 | 0,0034 |
| A07- | Linz Prinz Eugenstraße | Linz Hafenstraße | 0,45 | 0,0809 | 0,0014 | 0,45 | 0,0809 | 0,0022 | 0,63 | 0,1133 | 0,0033 | 0,63 | 0,1133 | 0,0051 | 0,91 | 0,1295 | 0,0041 | 0,91 | 0,1295 | 0,0065 |
| A07- | Linz Hafenstraße | Linz Urfa hr | 0,18 | 0,0318 | 0,0006 | 0,18 | 0,0318 | 0,0009 | 0,25 | 0,0445 | 0,0013 | 0,25 | 0,0445 | 0,0020 | 0,36 | 0,0509 | 0,0016 | 0,36 | 0,0509 | 0,0025 |
| A07- | Linz Urfa hr | Linz Dornach | 0,43 | 0,0770 | 0,0013 | 0,43 | 0,0770 | 0,0021 | 0,60 | 0,1078 | 0,0031 | 0,60 | 0,1078 | 0,0049 | 0,86 | 0,1232 | 0,0039 | 0,87 | 0,1232 | 0,0061 |
| A07- | Linz Dornach | Treffling | 0,94 | 0,1694 | 0,0030 | 0,95 | 0,1694 | 0,0047 | 1,32 | 0,2371 | 0,0068 | 1,33 | 0,2371 | 0,0107 | 1,90 | 0,2710 | 0,0086 | 1,90 | 0,2710 | 0,0135 |
| A07- | Treffling | Gallneukirchen | 0,71 | 0,1276 | 0,0022 | 0,71 | 0,1276 | 0,0035 | 1,00 | 0,1786 | 0,0051 | 1,00 | 0,1786 | 0,0081 | 1,43 | 0,2042 | 0,0065 | 1,44 | 0,2042 | 0,0102 |
| A07- | Gallneukirchen | Engerwitzdorf | 0,63 | 0,1137 | 0,0020 | 0,63 | 0,1137 | 0,0031 | 0,89 | 0,1592 | 0,0046 | 0,89 | 0,1592 | 0,0072 | 1,28 | 0,1819 | 0,0058 | 1,28 | 0,1819 | 0,0091 |
| A07- | Engerwitzdorf | Unterweikersdorf | 0,81 | 0,1458 | 0,0026 | 0,81 | 0,1458 | 0,0040 | 1,14 | 0,2041 | 0,0059 | 1,14 | 0,2041 | 0,0092 | 1,63 | 0,2332 | 0,0074 | 1,64 | 0,2332 | 0,0116 |
| A08- | KN Voralpenkreuz | Wels West | 2,49 | 0,4471 | 0,0078 | 2,50 | 0,4471 | 0,0123 | 3,50 | 0,6260 | 0,0180 | 3,51 | 0,6260 | 0,0283 | 5,02 | 0,7154 | 0,0227 | 5,03 | 0,7154 | 0,0357 |
| A08- | Wels West | KN Wels | 0,88 | 0,1577 | 0,0028 | 0,88 | 0,1577 | 0,0043 | 1,23 | 0,2208 | 0,0063 | 1,24 | 0,2208 | 0,0100 | 1,77 | 0,2523 | 0,0080 | 1,77 | 0,2523 | 0,0126 |
| A08- | KN Wels | Pichl/Bad Schallerbach | 0,97 | 0,1735 | 0,0030 | 0,97 | 0,1735 | 0,0048 | 1,36 | 0,2429 | 0,0070 | 1,36 | 0,2429 | 0,0110 | 1,95 | 0,2776 | 0,0088 | 1,95 | 0,2776 | 0,0138 |
| A08- | Pichl/Bad Schallerbach | Meggenhofen Gallspace | 2,44 | 0,4384 | 0,0077 | 2,45 | 0,4384 | 0,0121 | 3,43 | 0,6138 | 0,0176 | 3,44 | 0,6138 | 0,0277 | 4,92 | 0,7015 | 0,0223 | 4,93 | 0,7015 | 0,0350 |
| A08- | Meggenhofen Gallspace | Haag am Hausruck | 2,66 | 0,4778 | 0,0084 | 2,67 | 0,4778 | 0,0131 | 3,74 | 0,6690 | 0,0192 | 3,75 | 0,6690 | 0,0302 | 5,36 | 0,7645 | 0,0243 | 5,37 | 0,7645 | 0,0381 |
| A08- | Haag am Hausruck | Ried im Innkreis | 2,43 | 0,4361 | 0,0076 | 2,43 | 0,4361 | 0,0120 | 3,41 | 0,6105 | 0,0176 | 3,42 | 0,6105 | 0,0276 | 4,89 | 0,6977 | 0,0221 | 4,90 | 0,6977 | 0,0348 |
| A08- | Ried im Innkreis | Ort im Innkreis | 2,61 | 0,4680 | 0,0082 | 2,61 | 0,4680 | 0,0129 | 3,66 | 0,6553 | 0,0188 | 3,67 | 0,6553 | 0,0296 | 5,25 | 0,7489 | 0,0238 | 5,26 | 0,7489 | 0,0373 |
| A08- | Ort im Innkreis | Schärding Suben | 1,97 | 0,3533 | 0,0062 | 1,97 | 0,3533 | 0,0097 | 2,76 | 0,4946 | 0,0142 | 2,77 | 0,4946 | 0,0223 | 3,96 | 0,5652 | 0,0179 | 3,97 | 0,5652 | 0,0282 |
| A08- | Schärding Suben | Staatsgrenze Suben | 0,50 | 0,0893 | 0,0016 | 0,50 | 0,0893 | 0,0025 | 0,70 | 0,1250 | 0,0036 | 0,70 | 0,1250 | 0,0056 | 1,00 | 0,1428 | 0,0045 | 1,00 | 0,1428 | 0,0071 |
| A09- | KN Voralpenkreuz | Ried im Traunkreis | 1,23 | 0,2200 | 0,0039 | 1,23 | 0,2200 | 0,0061 | 1,72 | 0,3081 | 0,0089 | 1,73 | 0,3081 | 0,0139 | 2,47 | 0,3521 | 0,0112 | 2,47 | 0,3521 | 0,0175 |
| A09- | Ried im Traunkreis | Inzersdorf Kirchdorf | 2,30 | 0,4128 | 0,0072 | 2,30 | 0,4128 | 0,0114 | 3,23 | 0,5779 | 0,0166 | 3,24 | 0,5779 | 0,0261 | 4,63 | 0,6604 | 0,0209 | 4,64 | 0,6604 | 0,0329 |
| A09- | Inzersdorf Kirchdorf | Klaus | 2,80 | 0,5028 | 0,0088 | 2,81 | 0,5028 | 0,0138 | 3,93 | 0,7039 | 0,0202 | 3,94 | 0,7039 | 0,0318 | 5,64 | 0,8045 | 0,0255 | 5,65 | 0,8045 | 0,0401 |
| A09- | Klaus | St. Pankratz | 1,78 | 0,3196 | 0,0056 | 1,78 | 0,3196 | 0,0088 | 2,50 | 0,4474 | 0,0129 | 2,51 | 0,4474 | 0,0202 | 3,58 | 0,5114 | 0,0162 | 3,59 | 0,5114 | 0,0255 |
| A09- | St. Pankratz | Roßleiten Windischgarsten | 2,48 | 0,4459 | 0,0078 | 2,49 | 0,4459 | 0,0123 | 3,49 | 0,6243 | 0,0179 | 3,50 | 0,6243 | 0,0282 | 5,00 | 0,7135 | 0,0226 | 5,01 | 0,7135 | 0,0356 |
| A09- | Roßleiten Windischgarsten | Gleinkerau | 1,17 | 0,2096 | 0,0037 | 1,17 | 0,2096 | 0,0058 | 1,64 | 0,2934 | 0,0084 | 1,64 | 0,2934 | 0,0133 | 2,35 | 0,3354 | 0,0106 | 2,36 | 0,3354 | 0,0167 |
| A09- | Gleinkerau | Spital am Pyhrn | 0,88 | 0,1580 | 0,0028 | 0,88 | 0,1580 | 0,0043 | 1,24 | 0,2212 | 0,0064 | 1,24 | 0,2212 | 0,0100 | 1,77 | 0,2528 | 0,0080 | 1,78 | 0,2528 | 0,0126 |
| A09- | Spital am Pyhrn | Ardning / Admont | 4,53 | 0,4022 | 0,0070 | 4,54 | 0,4022 | 0,0111 | 6,35 | 0,5631 | 0,0162 | 6,36 | 0,5631 | 0,0254 | 9,33 | 0,6436 | 0,0204 | 9,34 | 0,6436 | 0,0321 |
| A09- | Ardning / Admont | Liezen | 0,51 | 0,0917 | 0,0016 | 0,51 | 0,0917 | 0,0025 | 0,72 | 0,1284 | 0,0037 | 0,72 | 0,1284 | 0,0058 | 1,03 | 0,1467 | 0,0047 | 1,03 | 0,1467 | 0,0073 |
| A09- | Liezen | Rottenmann | 1,07 | 0,1916 | 0,0034 | 1,07 | 0,1916 | 0,0053 | 1,50 | 0,2682 | 0,0077 | 1,50 | 0,2682 | 0,0121 | 2,15 | 0,3065 | 0,0097 | 2,15 | 0,3065 | 0,0153 |
| A09- | Rottenmann | Trieben | 2,66 | 0,4776 | 0,0084 | 2,67 | 0,4776 | 0,0131 | 3,73 | 0,6686 | 0,0192 | 3,74 | 0,6686 | 0,0302 | 5,36 | 0,7641 | 0,0242 | 5,37 | 0,7641 | 0,0381 |
| A09- | Trieben | Treglwang | 2,16 | 0,3883 | 0,0068 | 2,17 | 0,3883 | 0,0107 | 3,04 | 0,5436 | 0,0156 | 3,04 | 0,5436 | 0,0246 | 4,36 | 0,6212 | 0,0197 | 4,37 | 0,6212 | 0,0310 |
| A09- | Treglwang | Kalwang | 2,91 | 0,5218 | 0,0091 | 2,91 | 0,5218 | 0,0143 | 4,08 | 0,7305 | 0,0210 | 4,09 | 0,7305 | 0,0330 | 5,85 | 0,8349 | 0,0265 | 5,87 | 0,8349 | 0,0416 |
| A09- | Kalwang | Mautern | 1,35 | 0,2430 | 0,0043 | 1,36 | 0,2430 | 0,0067 | 1,90 | 0,3401 | 0,0098 | 1,90 | 0,3401 | 0,0154 | 2,73 | 0,3887 | 0,0123 | 2,73 | 0,3887 | 0,0194 |
| A09- | Mautern | Kammern | 1,52 | 0,2733 | 0,0048 | 1,53 | 0,2733 | 0,0075 | 2,14 | 0,3826 | 0,0110 | 2,14 | 0,3826 | 0,0173 | 3,07 | 0,4373 | 0,0139 | 3,07 | 0,4373 | 0,0218 |
| A09- | Kammern | Traboch | 1,59 | 0,2858 | 0,0050 | 1,60 | 0,2858 | 0,0079 | 2,23 | 0,4001 | 0,0115 | 2,24 | 0,4001 | 0,0181 | 3,21 | 0,4572 | 0,0145 | 3,21 | 0,4572 | 0,0228 |
| A09- | Traboch | Terminal St. Michael | 0,31 | 0,0561 | 0,0010 | 0,31 | 0,0561 | 0,0015 | 0,44 | 0,0786 | 0,0023 | 0,44 | 0,0786 | 0,0035 | 0,63 | 0,0898 | 0,0028 | 0,63 | 0,0898 | 0,0045 |
| A09- | Terminal St. Michael | KN St. Michael | 0,59 | 0,1052 | 0,0018 | 0,59 | 0,1052 | 0,0029 | 0,82 | 0,1473 | 0,0042 | 0,82 | 0,1473 | 0,0067 | 1,18 | 0,1683 | 0,0053 | 1,18 | 0,1683 | 0,0084 |
| A09- | KN St. Michael | Übelbach | 11,04 | 0,9797 | 0,0171 | 11,05 | 0,9797 | 0,0289 | 15,48 | 1,3716 | 0,0394 | 15,50 | 1,3716 | 0,0620 | 22,72 | 1,5676 | 0,0497 | 22,74 | 1,5676 | 0,0781 |
| A09- | Übelbach | KN Peggau Deutschfeistritz | 1,81 | 0,3240 | 0,0057 | 1,81 | 0,3240 | 0,0089 | 2,53 | 0,4537 | 0,0130 | 2,54 | 0,4537 | 0,0205 | 3,63 | 0,5185 | 0,0164 | 3,64 | 0,5185 | 0,0258 |
| A09- | KN Peggau Deutschfeistritz | Gratkorn Nord | 0,86 | 0,1535 | 0,0027 | 0,86 | 0,1535 | 0,0042 | 1,20 | 0,2149 | 0,0062 | 1,20 | 0,2149 | 0,0097 | 1,72 | 0,2456 | 0,0078 | 1,73 | 0,2456 | 0,0122 |
| A09- | Gratkorn Nord | Gratkorn Süd | 0,94 | 0,1686 | 0,0030 | 0,94 | 0,1686 | 0,0046 | 1,32 | 0,2360 | 0,0068 | 1,32 | 0,2360 | 0,0107 | 1,89 | 0,2698 | 0,0086 | 1,90 | 0,2698 | |

| | | | | | | | | | | | | | | | | | | | | |
|------|--|---|-------|--------|--------|-------|--------|--------|-------|--------|--------|-------|--------|--------|-------|--------|--------|-------|--------|--------|
| A10- | Hallein | Kuchl | 1,30 | 0,2342 | 0,0041 | 1,31 | 0,2342 | 0,0064 | 1,83 | 0,3278 | 0,0094 | 1,84 | 0,3278 | 0,0148 | 2,63 | 0,3747 | 0,0119 | 2,63 | 0,3747 | 0,0187 |
| A10- | Kuchl | Golling / Abtenau | 1,31 | 0,2354 | 0,0041 | 1,31 | 0,2354 | 0,0065 | 1,84 | 0,3296 | 0,0095 | 1,85 | 0,3296 | 0,0149 | 2,64 | 0,3766 | 0,0119 | 2,65 | 0,3766 | 0,0188 |
| A10- | Golling / Abtenau | Paß Lueg | 1,37 | 0,2456 | 0,0043 | 1,37 | 0,2456 | 0,0068 | 1,92 | 0,3439 | 0,0099 | 1,93 | 0,3439 | 0,0155 | 2,76 | 0,3930 | 0,0125 | 2,76 | 0,3930 | 0,0196 |
| A10- | Paß Lueg | Werfen | 1,95 | 0,3499 | 0,0061 | 1,95 | 0,3499 | 0,0096 | 2,94 | 0,4898 | 0,0141 | 2,74 | 0,4898 | 0,0221 | 3,92 | 0,5598 | 0,0178 | 3,93 | 0,5598 | 0,0279 |
| A10- | Werfen | Pfarrwerfen / Werfen | 0,25 | 0,0456 | 0,0008 | 0,25 | 0,0456 | 0,0013 | 0,36 | 0,0638 | 0,0018 | 0,36 | 0,0638 | 0,0029 | 0,51 | 0,0730 | 0,0023 | 0,51 | 0,0730 | 0,0036 |
| A10- | Pfarrwerfen / Werfen | KN Pongau | 0,55 | 0,0990 | 0,0017 | 0,55 | 0,0990 | 0,0027 | 0,77 | 0,1385 | 0,0040 | 0,78 | 0,1385 | 0,0063 | 1,11 | 0,1583 | 0,0050 | 1,11 | 0,1583 | 0,0079 |
| A101 | KN Pongau | Bischofshofen Mühlbach a. Hochkönig | 0,82 | 0,1472 | 0,0026 | 0,82 | 0,1472 | 0,0040 | 1,15 | 0,2061 | 0,0059 | 1,15 | 0,2061 | 0,0093 | 1,65 | 0,2355 | 0,0075 | 1,66 | 0,2355 | 0,0117 |
| A10- | KN Pongau | Lammertal Hütttau | 2,24 | 0,4025 | 0,0070 | 2,25 | 0,4025 | 0,0111 | 3,15 | 0,5635 | 0,0162 | 3,16 | 0,5635 | 0,0255 | 4,51 | 0,6440 | 0,0204 | 4,53 | 0,6440 | 0,0321 |
| A10- | Lammertal Hütttau | F. Verbindung GH Eben | 0,58 | 0,1036 | 0,0018 | 0,58 | 0,1036 | 0,0028 | 0,81 | 0,1450 | 0,0042 | 0,81 | 0,1450 | 0,0066 | 1,16 | 0,1658 | 0,0053 | 1,17 | 0,1658 | 0,0083 |
| A10- | F. Verbindung GH Eben | Eben | 0,27 | 0,0480 | 0,0008 | 0,27 | 0,0480 | 0,0013 | 0,38 | 0,0672 | 0,0019 | 0,38 | 0,0672 | 0,0030 | 0,54 | 0,0768 | 0,0024 | 0,54 | 0,0768 | 0,0038 |
| A10- | Eben | Radstadt Altenmarkt Graz | 0,59 | 0,1066 | 0,0019 | 0,60 | 0,1066 | 0,0029 | 0,83 | 0,1492 | 0,0043 | 0,84 | 0,1492 | 0,0067 | 1,20 | 0,1706 | 0,0054 | 1,20 | 0,1706 | 0,0085 |
| A10- | Radstadt Altenmarkt Graz | Flachau | 0,83 | 0,1491 | 0,0026 | 0,83 | 0,1491 | 0,0041 | 1,17 | 0,2087 | 0,0060 | 1,17 | 0,2087 | 0,0094 | 1,67 | 0,2385 | 0,0076 | 1,68 | 0,2385 | 0,0119 |
| A10- | Flachau | Flachauwinkel | 3,05 | 0,2908 | 0,0051 | 3,05 | 0,2908 | 0,0080 | 4,27 | 0,4071 | 0,0117 | 4,28 | 0,4071 | 0,0184 | 6,26 | 0,4653 | 0,0148 | 6,27 | 0,4653 | 0,0232 |
| A10- | Flachauwinkel | Zederhaus | 7,69 | 0,7328 | 0,0128 | 7,69 | 0,7328 | 0,0202 | 10,77 | 1,0260 | 0,0295 | 10,79 | 1,0260 | 0,0464 | 15,78 | 1,1725 | 0,0372 | 15,80 | 1,1725 | 0,0584 |
| A10- | Zederhaus | St. Michael/Lungau | 5,07 | 0,4835 | 0,0085 | 5,08 | 0,4835 | 0,0133 | 7,11 | 0,6769 | 0,0195 | 7,12 | 0,6769 | 0,0306 | 10,41 | 0,7736 | 0,0245 | 10,43 | 0,7736 | 0,0386 |
| A10- | St. Michael/Lungau | Rennweg Katschberg | 3,72 | 0,3545 | 0,0062 | 3,72 | 0,3545 | 0,0097 | 5,21 | 0,4963 | 0,0143 | 5,22 | 0,4963 | 0,0224 | 7,63 | 0,5672 | 0,0180 | 7,65 | 0,5672 | 0,0283 |
| A102 | Seeboden | KN Spittal Millstätter See | 0,43 | 0,0776 | 0,0014 | 0,43 | 0,0776 | 0,0021 | 0,61 | 0,1086 | 0,0031 | 0,61 | 0,1086 | 0,0049 | 0,87 | 0,1242 | 0,0039 | 0,87 | 0,1242 | 0,0062 |
| A102 | KN Spittal Millstätter See | Lendorf | 0,93 | 0,1674 | 0,0029 | 0,93 | 0,1674 | 0,0046 | 1,31 | 0,2344 | 0,0067 | 1,31 | 0,2344 | 0,0106 | 1,88 | 0,2678 | 0,0085 | 1,88 | 0,2678 | 0,0134 |
| A10- | Rennweg Katschberg | Gmünd Maltatal | 3,77 | 0,6774 | 0,0119 | 3,78 | 0,6774 | 0,0186 | 5,30 | 0,9483 | 0,0273 | 5,31 | 0,9483 | 0,0428 | 7,60 | 1,0838 | 0,0344 | 7,62 | 1,0838 | 0,0540 |
| A10- | Gmünd Maltatal | KN Spittal Millstätter See | 2,15 | 0,3855 | 0,0067 | 2,15 | 0,3855 | 0,0106 | 3,01 | 0,5397 | 0,0155 | 3,02 | 0,5397 | 0,0244 | 4,32 | 0,6168 | 0,0196 | 4,34 | 0,6168 | 0,0307 |
| A10- | KN Spittal Millstätter See | Spittal Ost | 1,63 | 0,2920 | 0,0051 | 1,63 | 0,2920 | 0,0080 | 2,28 | 0,4088 | 0,0118 | 2,29 | 0,4088 | 0,0185 | 3,28 | 0,4672 | 0,0148 | 3,28 | 0,4672 | 0,0233 |
| A10- | Spittal Ost | Paternion Feistritz | 2,81 | 0,5043 | 0,0088 | 2,82 | 0,5043 | 0,0139 | 3,94 | 0,7060 | 0,0203 | 3,95 | 0,7060 | 0,0319 | 5,66 | 0,8068 | 0,0256 | 5,67 | 0,8068 | 0,0402 |
| A10- | Paternion Feistritz | Villach West | 3,03 | 0,5435 | 0,0095 | 3,03 | 0,5435 | 0,0149 | 4,25 | 0,7609 | 0,0219 | 4,26 | 0,7609 | 0,0344 | 6,10 | 0,8696 | 0,0276 | 6,11 | 0,8696 | 0,0433 |
| A10- | Villach West | Villach Ossiacher See | 1,31 | 0,2350 | 0,0041 | 1,31 | 0,2350 | 0,0065 | 1,84 | 0,3289 | 0,0095 | 1,84 | 0,3289 | 0,0149 | 2,64 | 0,3759 | 0,0119 | 2,64 | 0,3759 | 0,0187 |
| A10- | Villach Ossiacher See | KN Villach | 1,02 | 0,1836 | 0,0032 | 1,02 | 0,1836 | 0,0050 | 1,44 | 0,2570 | 0,0074 | 1,44 | 0,2570 | 0,0116 | 2,06 | 0,2938 | 0,0093 | 2,06 | 0,2938 | 0,0146 |
| A11- | KN Villach | St. Niklas Faakersee | 0,73 | 0,1314 | 0,0023 | 0,73 | 0,1314 | 0,0036 | 1,03 | 0,1840 | 0,0053 | 1,03 | 0,1840 | 0,0083 | 1,47 | 0,2102 | 0,0067 | 1,48 | 0,2102 | 0,0105 |
| A11- | St. Niklas Faakersee | St. Jakob/Rosental | 1,84 | 0,3300 | 0,0058 | 1,84 | 0,3300 | 0,0091 | 2,58 | 0,4621 | 0,0133 | 2,59 | 0,4621 | 0,0209 | 3,70 | 0,5281 | 0,0167 | 3,71 | 0,5281 | 0,0263 |
| A11- | St. Jakob/Rosental | Staatsgrenze Karawankentunnel | 16,10 | 0,3883 | 0,0068 | 16,11 | 0,3883 | 0,0107 | 22,55 | 0,5436 | 0,0156 | 22,56 | 0,5436 | 0,0246 | 33,63 | 0,6212 | 0,0197 | 33,64 | 0,6212 | 0,0310 |
| A12- | Staatsgrenze Kufstein | Kufstein Nord | 0,36 | 0,0000 | 0,0000 | 0,36 | 0,0000 | 0,0000 | 0,51 | 0,0000 | 0,0000 | 0,51 | 0,0000 | 0,0000 | 0,76 | 0,0000 | 0,0000 | 0,76 | 0,0000 | 0,0000 |
| A12- | Kufstein Nord | Kufstein Süd | 0,93 | 0,0000 | 0,0000 | 0,93 | 0,0000 | 0,0000 | 1,31 | 0,0000 | 0,0000 | 1,31 | 0,0000 | 0,0000 | 1,96 | 0,0000 | 0,0000 | 1,96 | 0,0000 | 0,0000 |
| A12- | Kufstein Süd | Kirchbichl Langkampfen | 1,27 | 0,0000 | 0,0000 | 1,27 | 0,0000 | 0,0000 | 1,78 | 0,0000 | 0,0000 | 1,78 | 0,0000 | 0,0000 | 2,68 | 0,0000 | 0,0000 | 2,68 | 0,0000 | 0,0000 |
| A12- | Kirchbichl Langkampfen | Wörgl Ost St.Johann i. T. Brixental | 1,25 | 0,0000 | 0,0000 | 1,25 | 0,0000 | 0,0000 | 1,75 | 0,0000 | 0,0000 | 1,75 | 0,0000 | 0,0000 | 2,62 | 0,0000 | 0,0000 | 2,62 | 0,0000 | 0,0000 |
| A12- | Wörgl Ost St.Johann i. T. Brixental | Wörgl West | 0,66 | 0,0000 | 0,0000 | 0,66 | 0,0000 | 0,0000 | 0,92 | 0,0000 | 0,0000 | 0,92 | 0,0000 | 0,0000 | 1,38 | 0,0000 | 0,0000 | 1,38 | 0,0000 | 0,0000 |
| A12- | Wörgl West | Kramsach Rattenberg Brixlegg | 2,80 | 0,0000 | 0,0000 | 2,80 | 0,0000 | 0,0000 | 3,92 | 0,0000 | 0,0000 | 3,92 | 0,0000 | 0,0000 | 5,88 | 0,0000 | 0,0000 | 5,88 | 0,0000 | 0,0000 |
| A12- | Kramsach Rattenberg Brixlegg | Wiesing Achensee Zillertal | 1,72 | 0,0000 | 0,0000 | 1,72 | 0,0000 | 0,0000 | 2,40 | 0,0000 | 0,0000 | 2,40 | 0,0000 | 0,0000 | 3,61 | 0,0000 | 0,0000 | 3,61 | 0,0000 | 0,0000 |
| A12- | Wiesing Achensee Zillertal | Jenbach | 0,68 | 0,0000 | 0,0000 | 0,68 | 0,0000 | 0,0000 | 0,95 | 0,0000 | 0,0000 | 0,95 | 0,0000 | 0,0000 | 1,43 | 0,0000 | 0,0000 | 1,43 | 0,0000 | 0,0000 |
| A12- | Jenbach | Schwaz | 1,50 | 0,0000 | 0,0000 | 1,50 | 0,0000 | 0,0000 | 2,10 | 0,0000 | 0,0000 | 2,10 | 0,0000 | 0,0000 | 3,15 | 0,0000 | 0,0000 | 3,15 | 0,0000 | 0,0000 |
| A12- | Schwaz | Vomp | 0,86 | 0,0000 | 0,0000 | 0,86 | 0,0000 | 0,0000 | 1,20 | 0,0000 | 0,0000 | 1,20 | 0,0000 | 0,0000 | 1,80 | 0,0000 | 0,0000 | 1,80 | 0,0000 | 0,0000 |
| A12- | Vomp | Wattens | 1,77 | 0,0000 | 0,0000 | 1,77 | 0,0000 | 0,0000 | 2,47 | 0,0000 | 0,0000 | 2,47 | 0,0000 | 0,0000 | 3,71 | 0,0000 | 0,0000 | 3,71 | 0,0000 | 0,0000 |
| A12- | Wattens | Hall/Tirol Mitte | 1,57 | 0,0000 | 0,0000 | 1,57 | 0,0000 | 0,0000 | 2,19 | 0,0000 | 0,0000 | 2,19 | 0,0000 | 0,0000 | 3,29 | 0,0000 | 0,0000 | 3,29 | 0,0000 | 0,0000 |
| A12- | Hall/Tirol Mitte | Hall/Tirol West | 0,63 | 0,0000 | 0,0000 | 0,63 | 0,0000 | 0,0000 | 0,88 | 0,0000 | 0,0000 | 0,88 | 0,0000 | 0,0000 | 1,32 | 0,0000 | 0,0000 | 1,32 | 0,0000 | 0,0000 |
| A12- | Hall/Tirol West | A12 Innsbruck Ost | 0,70 | 0,0000 | 0,0000 | 0,70 | 0,0000 | 0,0000 | 0,97 | 0,0000 | 0,0000 | 0,97 | 0,0000 | 0,0000 | 1,46 | 0,0000 | 0,0000 | 1,46 | 0,0000 | 0,0000 |
| A12- | A12 Innsbruck Ost | Innsbruck Mitte | 0,48 | 0,0226 | 0,0004 | 0,48 | 0,0226 | 0,0006 | 0,67 | 0,0317 | 0,0009 | 0,67 | 0,0317 | 0,0014 | 0,99 | 0,0362 | 0,0011 | 0,99 | 0,0362 | 0,0018 |
| A12- | Innsbruck Mitte | A12 Innsbruck West | 0,71 | 0,1280 | 0,0022 | 0,71 | 0,1280 | 0,0035 | 1,00 | 0,1792 | 0,0052 | 1,00 | 0,1792 | 0,0081 | 1,44 | 0,2048 | 0,0065 | 1,44 | 0,2048 | 0,0102 |
| A12- | A12 Innsbruck West | Innsbruck Kranebitten | 0,93 | 0,1678 | 0,0029 | 0,94 | 0,1678 | 0,0046 | 1,31 | 0,2349 | 0,0068 | 1,32 | 0,2349 | 0,0106 | 1,88 | 0,2684 | 0,0085 | 1,89 | 0,2684 | 0,0134 |
| A12- | Innsbruck Kranebitten | Zirl Ost Garmisch Seefeld | 1,08 | 0,1947 | 0,0034 | 1,09 | 0,1947 | 0,0054 | 1,52 | 0,2726 | 0,0078 | 1,53 | 0,2726 | 0,0123 | 2,18 | 0,3115 | 0,0099 | 2,19 | 0,3115 | 0,0155 |
| A12- | Zirl Ost Garmisch Seefeld | Zirl West | 0,68 | 0,1218 | 0,0021 | 0,68 | 0,1218 | 0,0033 | 0,95 | 0,1705 | 0,0049 | 0,95 | 0,1705 | 0,0077 | 1,37 | 0,1949 | 0,0062 | 1,37 | 0,1949 | 0,0097 |
| A12- | Zirl West | Petttau | 1,22 | 0,2181 | 0,0038 | 1,22 | 0,2181 | 0,0060 | 1,71 | 0,3054 | 0,0088 | 1,71 | 0,3054 | 0,0138 | 2,45 | 0,3490 | 0,0111 | 2,45 | 0,3490 | 0,0174 |
| A12- | Petttau | Telfs Ost | 1,23 | 0,2205 | 0,0039 | 1,23 | 0,2205 | 0,0061 | 1,72 | 0,3087 | 0,0089 | 1,73 | 0,3087 | 0,0139 | 2,47 | 0,3528 | 0,0112 | 2,48 | 0,3528 | 0,0176 |
| A12- | Telfs Ost | Telfs West | 0,60 | 0,1077 | 0,0019 | 0,60 | 0,1077 | 0,0030 | 0,84 | 0,1508 | 0,0043 | 0,84 | 0,1508 | 0,0068 | 1,21 | 0,1723 | 0,0055 | 1,21 | 0,1723 | 0,0086 |
| A12- | Telfs West | Mötz Reutte | 1,94 | 0,3480 | 0,0061 | 1,94 | 0,3480 | 0,0096 | 2,72 | 0,4872 | 0,0140 | 2,73 | 0,4872 | 0,0220 | 3,90 | 0,5568 | 0,0177 | 3,91 | 0,5568 | 0,0278 |
| A12- | Mötz Reutte | Haiming Ötztal | 2,26 | 0,4048 | 0,0071 | 2,26 | 0,4048 | 0,0111 | 3,16 | 0,5667 | 0,0163 | 3,17 | 0,5667 | 0,0256 | 4,54 | 0,6477 | 0,0205 | 4,55 | 0,6477 | 0,0323 |
| A12- | Haiming Ötztal | Imst | 1,80 | 0,3222 | 0,0056 | 1,80 | 0,3222 | 0,0089 | 2,52 | 0,4511 | 0,0130 | 2,53 | 0,4511 | 0,0204 | 3,61 | 0,5156 | 0,0164 | 3,62 | 0,5156 | 0,0257 |
| A12- | Imst | Imst Au | 0,30 | 0,0546 | 0,0010 | 0,30 | 0,0546 | 0,0015 | 0,43 | 0,0764 | 0,0022 | 0,43 | 0,0764 | 0,0035 | 0,61 | 0,0873 | 0,0028 | 0,61 | 0,0873 | 0,0044 |
| A12- | Imst Au | Mils | 0,65 | 0,1172 | 0,0021 | 0,65 | 0,1172 | 0,0032 | 0,92 | 0,1641 | 0,0047 | 0,92 | 0,1641 | 0,0074 | 1,31 | 0,1875 | 0,0059 | 1,32 | 0,1875 | 0,0093 |
| A12- | Mils | Mils Schönwies | 1,05 | 0,1888 | 0,0033 | 1,05 | 0,1888 | 0,0052 | 1,48 | 0,2643 | 0,0076 | 1,48 | 0,2643 | 0,0119 | 2,12 | 0,3021 | 0,0096 | 2,12 | | |

| | | | | | | | | | | | | | | | | | | | | |
|------|------------------------------------|------------------------------------|------|--------|--------|------|--------|--------|------|--------|--------|------|--------|--------|------|--------|--------|------|--------|--------|
| A14- | Staatsgrenze Hörbranz | Hörbranz Lochau | 0,28 | 0,0504 | 0,0009 | 0,28 | 0,0504 | 0,0014 | 0,39 | 0,0706 | 0,0020 | 0,40 | 0,0706 | 0,0032 | 0,57 | 0,0807 | 0,0026 | 0,57 | 0,0807 | 0,0040 |
| A14- | Hörbranz Lochau | KN Bregenz | 1,73 | 0,3100 | 0,0054 | 1,73 | 0,3100 | 0,0085 | 2,42 | 0,4339 | 0,0125 | 2,43 | 0,4339 | 0,0196 | 3,48 | 0,4959 | 0,0157 | 3,49 | 0,4959 | 0,0247 |
| A14- | KN Bregenz | Lauterach Wolfurt | 0,09 | 0,0156 | 0,0003 | 0,09 | 0,0156 | 0,0004 | 0,12 | 0,0218 | 0,0006 | 0,12 | 0,0218 | 0,0010 | 0,17 | 0,0249 | 0,0008 | 0,17 | 0,0249 | 0,0012 |
| A14- | Lauterach Wolfurt | Wolfurt Lauterach | 0,77 | 0,1379 | 0,0024 | 0,77 | 0,1379 | 0,0038 | 1,08 | 0,1931 | 0,0056 | 1,08 | 0,1931 | 0,0087 | 1,55 | 0,2207 | 0,0070 | 1,55 | 0,2207 | 0,0110 |
| A14- | Wolfurt Lauterach | Dornbirn Nord Bregenzerwald | 0,30 | 0,0534 | 0,0009 | 0,30 | 0,0534 | 0,0015 | 0,42 | 0,0747 | 0,0021 | 0,42 | 0,0747 | 0,0034 | 0,60 | 0,0854 | 0,0027 | 0,60 | 0,0854 | 0,0043 |
| A14- | Dornbirn Nord Bregenzerwald | Dornbirn Süd Lustenau | 0,83 | 0,1491 | 0,0026 | 0,83 | 0,1491 | 0,0041 | 1,17 | 0,2087 | 0,0060 | 1,17 | 0,2087 | 0,0094 | 1,67 | 0,2385 | 0,0076 | 1,68 | 0,2385 | 0,0119 |
| A14- | Dornbirn Süd Lustenau | Hohenems | 1,17 | 0,2098 | 0,0037 | 1,17 | 0,2098 | 0,0058 | 1,64 | 0,2937 | 0,0084 | 1,64 | 0,2937 | 0,0133 | 2,35 | 0,3356 | 0,0106 | 2,36 | 0,3356 | 0,0167 |
| A14- | Hohenems | Altach Götzis | 0,76 | 0,1368 | 0,0024 | 0,76 | 0,1368 | 0,0038 | 1,07 | 0,1915 | 0,0055 | 1,07 | 0,1915 | 0,0087 | 1,53 | 0,2188 | 0,0069 | 1,54 | 0,2188 | 0,0109 |
| A14- | Altach Götzis | Götzis | 0,58 | 0,1043 | 0,0018 | 0,58 | 0,1043 | 0,0029 | 0,82 | 0,1460 | 0,0042 | 0,82 | 0,1460 | 0,0066 | 1,17 | 0,1668 | 0,0053 | 1,17 | 0,1668 | 0,0083 |
| A14- | Götzis | Klaus Koblach | 0,50 | 0,0906 | 0,0016 | 0,51 | 0,0906 | 0,0025 | 0,71 | 0,1268 | 0,0036 | 0,71 | 0,1268 | 0,0057 | 1,02 | 0,1449 | 0,0046 | 1,02 | 0,1449 | 0,0072 |
| A14- | Klaus Koblach | Rankweil | 0,89 | 0,1592 | 0,0028 | 0,89 | 0,1592 | 0,0044 | 1,24 | 0,2228 | 0,0064 | 1,25 | 0,2228 | 0,0101 | 1,79 | 0,2547 | 0,0081 | 1,79 | 0,2547 | 0,0127 |
| A14- | Rankweil | Feldkirch Frastanz | 1,26 | 0,2267 | 0,0040 | 1,27 | 0,2267 | 0,0062 | 1,77 | 0,3174 | 0,0091 | 1,78 | 0,3174 | 0,0143 | 2,54 | 0,3628 | 0,0115 | 2,55 | 0,3628 | 0,0181 |
| A14- | Feldkirch Frastanz | Nenzing Bludesch | 2,00 | 0,3585 | 0,0063 | 2,00 | 0,3585 | 0,0099 | 2,80 | 0,5019 | 0,0144 | 2,81 | 0,5019 | 0,0227 | 4,02 | 0,5736 | 0,0182 | 4,03 | 0,5736 | 0,0286 |
| A14- | Nenzing Bludesch | Bludenz Nüziders | 1,48 | 0,2662 | 0,0047 | 1,49 | 0,2662 | 0,0073 | 2,08 | 0,3726 | 0,0107 | 2,09 | 0,3726 | 0,0168 | 2,99 | 0,4259 | 0,0135 | 2,99 | 0,4259 | 0,0212 |
| A14- | Bludenz Nüziders | Brandnertal | 0,21 | 0,0370 | 0,0006 | 0,21 | 0,0370 | 0,0010 | 0,29 | 0,0519 | 0,0015 | 0,29 | 0,0519 | 0,0023 | 0,42 | 0,0593 | 0,0019 | 0,42 | 0,0593 | 0,0030 |
| A14- | Brandnertal | Bludenz Bürs | 0,34 | 0,0618 | 0,0011 | 0,35 | 0,0618 | 0,0017 | 0,48 | 0,0865 | 0,0025 | 0,48 | 0,0865 | 0,0039 | 0,69 | 0,0989 | 0,0031 | 0,69 | 0,0989 | 0,0049 |
| A14- | Bludenz Bürs | Bludenz Montafon | 0,49 | 0,0876 | 0,0015 | 0,49 | 0,0876 | 0,0024 | 0,68 | 0,1226 | 0,0035 | 0,69 | 0,1226 | 0,0055 | 0,98 | 0,1402 | 0,0044 | 0,99 | 0,1402 | 0,0070 |
| A141 | KN Bregenz | Bregenz Citytunnel | 0,45 | 0,0802 | 0,0014 | 0,45 | 0,0802 | 0,0022 | 0,63 | 0,1123 | 0,0032 | 0,63 | 0,1123 | 0,0051 | 0,90 | 0,1284 | 0,0041 | 0,90 | 0,1284 | 0,0064 |
| A21- | KN Steinhäusl | Hochstraß | 0,74 | 0,1324 | 0,0023 | 0,74 | 0,1324 | 0,0036 | 1,03 | 0,1853 | 0,0053 | 1,04 | 0,1853 | 0,0084 | 1,48 | 0,2118 | 0,0067 | 1,49 | 0,2118 | 0,0106 |
| A21- | Hochstraß | Alland | 2,58 | 0,4624 | 0,0081 | 2,58 | 0,4624 | 0,0127 | 3,62 | 0,6474 | 0,0186 | 3,63 | 0,6474 | 0,0292 | 5,19 | 0,7399 | 0,0235 | 5,20 | 0,7399 | 0,0369 |
| A21- | Alland | Mayerling | 0,52 | 0,0939 | 0,0016 | 0,52 | 0,0939 | 0,0026 | 0,73 | 0,1314 | 0,0038 | 0,74 | 0,1314 | 0,0059 | 1,05 | 0,1502 | 0,0048 | 1,06 | 0,1502 | 0,0075 |
| A21- | Mayerling | Heiligenkreuz | 1,21 | 0,2175 | 0,0038 | 1,21 | 0,2175 | 0,0060 | 1,70 | 0,3045 | 0,0088 | 1,71 | 0,3045 | 0,0138 | 2,44 | 0,3480 | 0,0110 | 2,45 | 0,3480 | 0,0173 |
| A21- | Heiligenkreuz | Heiligenbrühl | 0,68 | 0,1212 | 0,0021 | 0,68 | 0,1212 | 0,0033 | 0,95 | 0,1697 | 0,0049 | 0,95 | 0,1697 | 0,0077 | 1,36 | 0,1940 | 0,0062 | 1,36 | 0,1940 | 0,0097 |
| A21- | Hinterbrühl | Gießhübl | 1,27 | 0,2274 | 0,0040 | 1,27 | 0,2274 | 0,0063 | 1,78 | 0,3184 | 0,0092 | 1,78 | 0,3184 | 0,0144 | 2,55 | 0,3638 | 0,0115 | 2,56 | 0,3638 | 0,0181 |
| A21- | Gießhübl | Brunn/Gebirge | 1,06 | 0,1903 | 0,0033 | 1,06 | 0,1903 | 0,0052 | 1,49 | 0,2664 | 0,0077 | 1,49 | 0,2664 | 0,0120 | 2,13 | 0,3044 | 0,0097 | 2,14 | 0,3044 | 0,0152 |
| A21- | Brunn/Gebirge | KN Vösendorf | 0,47 | 0,0846 | 0,0015 | 0,47 | 0,0846 | 0,0023 | 0,66 | 0,1185 | 0,0034 | 0,66 | 0,1185 | 0,0054 | 0,95 | 0,1354 | 0,0043 | 0,95 | 0,1354 | 0,0068 |
| A22- | KN Wien Kaisermühlen | Kaisermühlen | 0,37 | 0,0669 | 0,0012 | 0,37 | 0,0669 | 0,0018 | 0,52 | 0,0936 | 0,0027 | 0,52 | 0,0936 | 0,0042 | 0,75 | 0,1070 | 0,0034 | 0,75 | 0,1070 | 0,0053 |
| A22- | Kaisermühlen | Reichsbrücke | 0,31 | 0,0554 | 0,0010 | 0,31 | 0,0554 | 0,0015 | 0,43 | 0,0776 | 0,0022 | 0,43 | 0,0776 | 0,0035 | 0,62 | 0,0887 | 0,0028 | 0,62 | 0,0887 | 0,0044 |
| A22- | Reichsbrücke | Kagran Vienna International Center | 0,12 | 0,0214 | 0,0004 | 0,12 | 0,0214 | 0,0006 | 0,17 | 0,0299 | 0,0009 | 0,17 | 0,0299 | 0,0014 | 0,24 | 0,0342 | 0,0011 | 0,24 | 0,0342 | 0,0017 |
| A22- | Kagran Vienna International Center | Brigittenauebrücke | 0,19 | 0,0342 | 0,0006 | 0,19 | 0,0342 | 0,0009 | 0,27 | 0,0479 | 0,0014 | 0,27 | 0,0479 | 0,0022 | 0,38 | 0,0547 | 0,0017 | 0,38 | 0,0547 | 0,0027 |
| A22- | Brigittenauebrücke | Floridsdorferbrücke | 0,31 | 0,0552 | 0,0010 | 0,31 | 0,0552 | 0,0015 | 0,43 | 0,0773 | 0,0022 | 0,43 | 0,0773 | 0,0035 | 0,62 | 0,0883 | 0,0028 | 0,62 | 0,0883 | 0,0044 |
| A22- | Floridsdorferbrücke | KN Gürtel Nordbrücke | 0,20 | 0,0352 | 0,0006 | 0,20 | 0,0352 | 0,0010 | 0,28 | 0,0493 | 0,0014 | 0,28 | 0,0493 | 0,0022 | 0,39 | 0,0563 | 0,0018 | 0,40 | 0,0563 | 0,0028 |
| A22- | KN Gürtel Nordbrücke | Strebersdorf | 0,67 | 0,1203 | 0,0021 | 0,67 | 0,1203 | 0,0033 | 0,94 | 0,1684 | 0,0048 | 0,94 | 0,1684 | 0,0076 | 1,35 | 0,1925 | 0,0061 | 1,35 | 0,1925 | 0,0096 |
| A221 | Wien Nordbrücke | KN Gürtel Nordbrücke | 0,20 | 0,0355 | 0,0006 | 0,20 | 0,0355 | 0,0010 | 0,28 | 0,0497 | 0,0014 | 0,28 | 0,0497 | 0,0022 | 0,40 | 0,0568 | 0,0018 | 0,40 | 0,0568 | 0,0028 |
| A221 | KN Gürtel Nordbrücke | Wien Pragerstraße | 0,21 | 0,0382 | 0,0007 | 0,21 | 0,0382 | 0,0010 | 0,30 | 0,0535 | 0,0015 | 0,30 | 0,0535 | 0,0024 | 0,43 | 0,0611 | 0,0019 | 0,43 | 0,0611 | 0,0030 |
| A221 | Wien Pragerstraße | Wien Neujedlersdorf | 0,09 | 0,0167 | 0,0003 | 0,09 | 0,0167 | 0,0005 | 0,13 | 0,0234 | 0,0007 | 0,13 | 0,0234 | 0,0011 | 0,19 | 0,0268 | 0,0008 | 0,19 | 0,0268 | 0,0013 |
| A221 | Wien Neujedlersdorf | Brünnerstr/Shuttlewortstraße | 0,24 | 0,0424 | 0,0007 | 0,24 | 0,0424 | 0,0012 | 0,33 | 0,0594 | 0,0017 | 0,33 | 0,0594 | 0,0027 | 0,48 | 0,0678 | 0,0022 | 0,48 | 0,0678 | 0,0034 |
| A22- | Strebersdorf | Korneuburg Ost | 1,35 | 0,2424 | 0,0042 | 1,35 | 0,2424 | 0,0067 | 1,90 | 0,3394 | 0,0098 | 1,90 | 0,3394 | 0,0153 | 2,72 | 0,3878 | 0,0123 | 2,73 | 0,3878 | 0,0193 |
| A222 | Strebersdorf | Wien Vohburggasse | 0,17 | 0,0301 | 0,0005 | 0,17 | 0,0301 | 0,0008 | 0,24 | 0,0422 | 0,0012 | 0,24 | 0,0422 | 0,0019 | 0,34 | 0,0482 | 0,0015 | 0,34 | 0,0482 | 0,0024 |
| A22- | Korneuburg Ost | KN Korneuburg | 0,87 | 0,1564 | 0,0027 | 0,87 | 0,1564 | 0,0043 | 1,22 | 0,2190 | 0,0063 | 1,23 | 0,2190 | 0,0099 | 1,75 | 0,2503 | 0,0079 | 1,76 | 0,2503 | 0,0125 |
| A22- | KN Korneuburg | Stockerau Ost | 1,27 | 0,2276 | 0,0040 | 1,27 | 0,2276 | 0,0063 | 1,78 | 0,3186 | 0,0092 | 1,78 | 0,3186 | 0,0144 | 2,55 | 0,3642 | 0,0116 | 2,56 | 0,3642 | 0,0182 |
| A22- | Stockerau Ost | Stockerau Mitte | 0,51 | 0,0908 | 0,0016 | 0,51 | 0,0908 | 0,0025 | 0,71 | 0,1271 | 0,0037 | 0,71 | 0,1271 | 0,0057 | 1,02 | 0,1452 | 0,0046 | 1,02 | 0,1452 | 0,0072 |
| A22- | Stockerau Mitte | KN Stockerau/West | 0,43 | 0,0771 | 0,0013 | 0,43 | 0,0771 | 0,0021 | 0,60 | 0,1079 | 0,0031 | 0,60 | 0,1079 | 0,0049 | 0,86 | 0,1233 | 0,0039 | 0,87 | 0,1233 | 0,0061 |
| A23- | Altmannsdorferstraße | KN Wien Inzersdorf | 0,38 | 0,0674 | 0,0012 | 0,38 | 0,0674 | 0,0019 | 0,53 | 0,0944 | 0,0027 | 0,53 | 0,0944 | 0,0043 | 0,76 | 0,1079 | 0,0034 | 0,76 | 0,1079 | 0,0054 |
| A23- | KN Wien Inzersdorf | Favoriten | 0,95 | 0,1701 | 0,0030 | 0,95 | 0,1701 | 0,0047 | 1,33 | 0,2381 | 0,0068 | 1,33 | 0,2381 | 0,0108 | 1,91 | 0,2721 | 0,0086 | 1,91 | 0,2721 | 0,0136 |
| A23- | Favoriten | KN Gürtel Landstraßer Hauptstraße | 0,59 | 0,1065 | 0,0019 | 0,59 | 0,1065 | 0,0029 | 0,83 | 0,1491 | 0,0043 | 0,84 | 0,1491 | 0,0067 | 1,19 | 0,1704 | 0,0054 | 1,20 | 0,1704 | 0,0085 |
| A23- | KN Gürtel Landstraßer Hauptstraße | St. Marx | 0,23 | 0,0404 | 0,0007 | 0,23 | 0,0404 | 0,0011 | 0,32 | 0,0566 | 0,0016 | 0,32 | 0,0566 | 0,0026 | 0,45 | 0,0647 | 0,0021 | 0,45 | 0,0647 | 0,0032 |
| A23- | St. Marx | KN Wien Prater | 0,19 | 0,0343 | 0,0006 | 0,19 | 0,0343 | 0,0009 | 0,27 | 0,0480 | 0,0014 | 0,27 | 0,0480 | 0,0022 | 0,38 | 0,0549 | 0,0017 | 0,39 | 0,0549 | 0,0027 |
| A23- | KN Wien Prater | Handelskai | 0,42 | 0,0762 | 0,0013 | 0,43 | 0,0762 | 0,0021 | 0,60 | 0,1067 | 0,0031 | 0,60 | 0,1067 | 0,0048 | 0,85 | 0,1219 | 0,0039 | 0,86 | 0,1219 | 0,0061 |
| A23- | Handelskai | KN Wien Kaisermühlen | 0,19 | 0,0348 | 0,0006 | 0,19 | 0,0348 | 0,0010 | 0,27 | 0,0488 | 0,0014 | 0,27 | 0,0488 | 0,0022 | 0,39 | 0,0557 | 0,0018 | 0,39 | 0,0557 | 0,0028 |
| A23- | KN Wien Kaisermühlen | Groß Enzersdorf Stadlau | 0,53 | 0,0956 | 0,0017 | 0,53 | 0,0956 | 0,0026 | 0,75 | 0,1338 | 0,0038 | 0,75 | 0,1338 | 0,0060 | 1,07 | 0,1530 | 0,0049 | 1,08 | 0,1530 | 0,0076 |
| A23- | Groß Enzersdorf Stadlau | Hirschstetten | 0,30 | 0,0536 | 0,0009 | 0,30 | 0,0536 | 0,0015 | 0,42 | 0,0750 | 0,0022 | 0,42 | 0,0750 | 0,0034 | 0,60 | 0,0858 | 0,0027 | 0,60 | 0,0858 | 0,0043 |
| A233 | KN Gürtel Landstraßer Hauptstraße | Wien Gürtel | 0,17 | 0,0313 | 0,0005 | 0,17 | 0,0313 | 0,0009 | 0,24 | 0,0438 | 0,0013 | 0,25 | 0,0438 | 0,0020 | 0,35 | 0,0500 | 0,0016 | 0,35 | 0,0500 | 0,0025 |
| A25- | KN A1/A25 Passau Wels | Weißkirchen | 1,96 | 0,3526 | 0,0062 | 1,97 | 0,3526 | 0,0097 | 2,76 | 0,4936 | 0,0142 | 2,76 | 0,4936 | 0,0223 | 3,95 | 0,5642 | 0,0179 | 3,97 | 0,5642 | 0,0281 |
| A25- | Weißkirchen | Marchtrenk Wels Ost | 0,70 | 0,1256 | 0,0022 | 0,70 | 0,1256 | 0,0035 | 0,98 | 0,1759 | 0,0051 | 0,99 | 0,1759 | 0,0079 | 1,41 | 0,2010 | 0,0064 | 1,41 | 0,2010 | 0,0100 |
| A25- | Marchtrenk Wels Ost | ÖBB Terminal Wels | 0,19 | 0,0338 | 0,0006 | 0,19 | 0,0338 | 0,0009 | 0,26 | 0,0473 | 0,0014 | 0,26 | 0,0473 | 0,0021 | 0,38 | 0,0541 | 0,0017 | 0,38 | 0,0541 | 0,0027 |
| | | | | | | | | | | | | | | | | | | | | |

| | | | | | | | | | | | | | | | | | | | | |
|------|-----------------------------------|-----------------------------------|------|--------|--------|------|--------|--------|------|--------|--------|------|--------|--------|------|--------|--------|------|----------|--------|
| S01- | Seyring | KN Eibesbrunn | 0,92 | 0,1649 | 0,0029 | 0,92 | 0,1649 | 0,0045 | 1,29 | 0,2308 | 0,0066 | 1,29 | 0,2308 | 0,0104 | 1,85 | 0,2638 | 0,0084 | 1,85 | 0,2638 | 0,0131 |
| S01- | KN Eibesbrunn | Hagenbrunn | 0,72 | 0,1298 | 0,0023 | 0,72 | 0,1298 | 0,0036 | 1,01 | 0,1817 | 0,0052 | 1,02 | 0,1817 | 0,0082 | 1,46 | 0,2077 | 0,0066 | 1,46 | 0,2077 | 0,0104 |
| S01- | Hagenbrunn | Korneuburg Nord | 1,55 | 0,2777 | 0,0049 | 1,55 | 0,2777 | 0,0076 | 2,17 | 0,3888 | 0,0112 | 2,18 | 0,3888 | 0,0176 | 3,11 | 0,4443 | 0,0141 | 3,12 | 0,4443 | 0,0221 |
| S01- | Korneuburg Nord | Korneuburg West | 0,63 | 0,1126 | 0,0020 | 0,63 | 0,1126 | 0,0031 | 0,88 | 0,1577 | 0,0045 | 0,88 | 0,1577 | 0,0071 | 1,26 | 0,1802 | 0,0057 | 1,27 | 0,1802 | 0,0090 |
| S01- | Korneuburg West | KN Korneuburg | 0,20 | 0,0359 | 0,0006 | 0,20 | 0,0359 | 0,0010 | 0,28 | 0,0503 | 0,0014 | 0,28 | 0,0503 | 0,0023 | 0,40 | 0,0575 | 0,0018 | 0,40 | 0,0575 | 0,0029 |
| S02- | Hirschstetten | Gewerbepark Stadlau | 0,22 | 0,0386 | 0,0007 | 0,22 | 0,0386 | 0,0011 | 0,30 | 0,0540 | 0,0016 | 0,30 | 0,0540 | 0,0024 | 0,43 | 0,0618 | 0,0020 | 0,43 | 0,0618 | 0,0031 |
| S02- | Gewerbepark Stadlau | Breitenleer Straße | 0,12 | 0,0214 | 0,0004 | 0,12 | 0,0214 | 0,0006 | 0,17 | 0,0300 | 0,0009 | 0,17 | 0,0300 | 0,0014 | 0,24 | 0,0342 | 0,0011 | 0,24 | 0,0342 | 0,0017 |
| S02- | Breitenleer Straße | Rautenweg | 0,20 | 0,0355 | 0,0006 | 0,20 | 0,0355 | 0,0010 | 0,28 | 0,0497 | 0,0014 | 0,28 | 0,0497 | 0,0022 | 0,40 | 0,0568 | 0,0018 | 0,40 | 0,0568 | 0,0028 |
| S02- | Rautenweg | Hermann Gebauer Straße | 0,22 | 0,0390 | 0,0007 | 0,22 | 0,0390 | 0,0011 | 0,31 | 0,0547 | 0,0016 | 0,31 | 0,0547 | 0,0025 | 0,44 | 0,0625 | 0,0020 | 0,44 | 0,0625 | 0,0031 |
| S02- | Hermann Gebauer Straße | Angerner Straße | 0,79 | 0,1413 | 0,0025 | 0,79 | 0,1413 | 0,0039 | 1,10 | 0,1978 | 0,0057 | 1,11 | 0,1978 | 0,0089 | 1,58 | 0,2260 | 0,0072 | 1,59 | 0,2260 | 0,0113 |
| S03- | KN Stockerau/West | Stockerau Nord | 0,22 | 0,0399 | 0,0007 | 0,22 | 0,0399 | 0,0011 | 0,31 | 0,0559 | 0,0016 | 0,31 | 0,0559 | 0,0025 | 0,45 | 0,0639 | 0,0020 | 0,45 | 0,0639 | 0,0032 |
| S03- | Stockerau Nord | Sierndorf | 1,20 | 0,2146 | 0,0038 | 1,20 | 0,2146 | 0,0059 | 1,68 | 0,3004 | 0,0086 | 1,68 | 0,3004 | 0,0136 | 2,41 | 0,3433 | 0,0109 | 2,41 | 0,3433 | 0,0171 |
| S03- | Sierndorf | Obermallebarn | 0,80 | 0,1441 | 0,0025 | 0,80 | 0,1441 | 0,0040 | 1,13 | 0,2017 | 0,0058 | 1,13 | 0,2017 | 0,0091 | 1,62 | 0,2305 | 0,0073 | 1,62 | 0,2305 | 0,0115 |
| S03- | Obermallebarn | Göllersdorf | 1,06 | 0,1902 | 0,0033 | 1,06 | 0,1902 | 0,0052 | 1,49 | 0,2663 | 0,0077 | 1,49 | 0,2663 | 0,0120 | 2,13 | 0,3044 | 0,0097 | 2,14 | 0,3044 | 0,0152 |
| S03- | Göllersdorf | Großstelzendorf | 0,42 | 0,0762 | 0,0013 | 0,43 | 0,0762 | 0,0021 | 0,60 | 0,1067 | 0,0031 | 0,60 | 0,1067 | 0,0048 | 0,85 | 0,1219 | 0,0039 | 0,86 | 0,1219 | 0,0061 |
| S03- | Großstelzendorf | Hollabrunn Süd | 1,02 | 0,1832 | 0,0032 | 1,02 | 0,1832 | 0,0050 | 1,43 | 0,2565 | 0,0074 | 1,44 | 0,2565 | 0,0116 | 2,06 | 0,2932 | 0,0093 | 2,06 | 0,2932 | 0,0146 |
| S04- | KN Mattersburg | Sigleß | 0,53 | 0,0947 | 0,0017 | 0,53 | 0,0947 | 0,0026 | 0,74 | 0,1326 | 0,0038 | 0,74 | 0,1326 | 0,0060 | 1,06 | 0,1516 | 0,0048 | 1,07 | 0,1516 | 0,0076 |
| S04- | Sigleß | Bad Sauerbrunn | 1,23 | 0,2213 | 0,0039 | 1,24 | 0,2213 | 0,0061 | 1,73 | 0,3098 | 0,0089 | 1,74 | 0,3098 | 0,0140 | 2,48 | 0,3541 | 0,0112 | 2,49 | 0,3541 | 0,0177 |
| S04- | Bad Sauerbrunn | Neudörfel | 0,52 | 0,0930 | 0,0016 | 0,52 | 0,0930 | 0,0026 | 0,73 | 0,1302 | 0,0037 | 0,73 | 0,1302 | 0,0059 | 1,04 | 0,1488 | 0,0047 | 1,05 | 0,1488 | 0,0074 |
| S04- | Neudörfel | Wr. Neustadt Ost | 0,54 | 0,0974 | 0,0017 | 0,54 | 0,0974 | 0,0027 | 0,76 | 0,1363 | 0,0039 | 0,76 | 0,1363 | 0,0062 | 1,09 | 0,1558 | 0,0049 | 1,09 | 0,1558 | 0,0078 |
| S04- | Wr. Neustadt Ost | Katzelsdorf | 0,25 | 0,0456 | 0,0008 | 0,25 | 0,0456 | 0,0013 | 0,36 | 0,0638 | 0,0018 | 0,36 | 0,0638 | 0,0029 | 0,51 | 0,0730 | 0,0023 | 0,51 | 0,0730 | 0,0036 |
| S04- | Katzelsdorf | Lanzenkirchen | 0,21 | 0,0382 | 0,0007 | 0,21 | 0,0382 | 0,0010 | 0,30 | 0,0534 | 0,0015 | 0,30 | 0,0534 | 0,0024 | 0,43 | 0,0611 | 0,0019 | 0,43 | 0,0611 | 0,0030 |
| S04- | Lanzenkirchen | Wr. Neustadt Süd | 0,19 | 0,0338 | 0,0006 | 0,19 | 0,0338 | 0,0009 | 0,26 | 0,0474 | 0,0014 | 0,27 | 0,0474 | 0,0021 | 0,38 | 0,0541 | 0,0017 | 0,38 | 0,0541 | 0,0027 |
| S04- | Wr. Neustadt Süd | KN Wr. Neustadt | 0,31 | 0,0560 | 0,0010 | 0,31 | 0,0560 | 0,0015 | 0,44 | 0,0784 | 0,0023 | 0,44 | 0,0784 | 0,0035 | 0,63 | 0,0896 | 0,0028 | 0,63 | 0,0896 | 0,0045 |
| S05- | KN Stockerau/West | Tulln | 2,15 | 0,3864 | 0,0068 | 2,16 | 0,3864 | 0,0106 | 3,02 | 0,5410 | 0,0156 | 3,03 | 0,5410 | 0,0244 | 4,33 | 0,6182 | 0,0196 | 4,35 | 0,6182 | 0,0308 |
| S05- | Tulln | Königsbrunn / Wagram | 2,70 | 0,4840 | 0,0085 | 2,70 | 0,4840 | 0,0133 | 3,78 | 0,6776 | 0,0195 | 3,79 | 0,6776 | 0,0306 | 5,43 | 0,7744 | 0,0246 | 5,44 | 0,7744 | 0,0386 |
| S05- | Königsbrunn / Wagram | Kirchberg/Wagram | 0,72 | 0,1290 | 0,0023 | 0,72 | 0,1290 | 0,0035 | 1,01 | 0,1806 | 0,0052 | 1,01 | 0,1806 | 0,0082 | 1,45 | 0,2064 | 0,0065 | 1,45 | 0,2064 | 0,0103 |
| S05- | Kirchberg/Wagram | Fels / Wagram | 0,54 | 0,0966 | 0,0017 | 0,54 | 0,0966 | 0,0027 | 0,76 | 0,1353 | 0,0039 | 0,76 | 0,1353 | 0,0061 | 1,08 | 0,1546 | 0,0049 | 1,09 | 0,1546 | 0,0077 |
| S05- | Fels / Wagram | Grafenwörth | 1,24 | 0,2225 | 0,0039 | 1,24 | 0,2225 | 0,0061 | 1,74 | 0,3115 | 0,0090 | 1,74 | 0,3115 | 0,0141 | 2,50 | 0,3560 | 0,0113 | 2,50 | 0,3560 | 0,0177 |
| S05- | Grafenwörth | Jettsdorf | 0,55 | 0,0995 | 0,0017 | 0,56 | 0,0995 | 0,0027 | 0,78 | 0,1393 | 0,0040 | 0,78 | 0,1393 | 0,0063 | 1,12 | 0,1592 | 0,0050 | 1,12 | 0,1592 | 0,0079 |
| S06- | KN Seebenstein | Neunkirchen | 0,85 | 0,1518 | 0,0027 | 0,85 | 0,1518 | 0,0042 | 1,19 | 0,2125 | 0,0061 | 1,19 | 0,2125 | 0,0096 | 1,70 | 0,2429 | 0,0077 | 1,71 | 0,2429 | 0,0121 |
| S06- | Neunkirchen | Gloggnitz | 2,71 | 0,4868 | 0,0085 | 2,72 | 0,4868 | 0,0134 | 3,81 | 0,6815 | 0,0196 | 3,82 | 0,6815 | 0,0308 | 5,46 | 0,7789 | 0,0247 | 5,47 | 0,7789 | 0,0388 |
| S06- | Gloggnitz | Maria Schutz | 1,73 | 0,3103 | 0,0054 | 1,73 | 0,3103 | 0,0085 | 2,43 | 0,4344 | 0,0125 | 2,43 | 0,4344 | 0,0196 | 3,48 | 0,4964 | 0,0157 | 3,49 | 0,4964 | 0,0247 |
| S06- | Maria Schutz | Spital / Semmering | 1,47 | 0,2634 | 0,0046 | 1,47 | 0,2634 | 0,0072 | 2,06 | 0,3687 | 0,0106 | 2,06 | 0,3687 | 0,0167 | 2,95 | 0,4214 | 0,0134 | 2,96 | 0,4214 | 0,0210 |
| S06- | Spital / Semmering | Mürzzuschlag Ost | 1,23 | 0,2200 | 0,0039 | 1,23 | 0,2200 | 0,0061 | 1,72 | 0,3080 | 0,0089 | 1,72 | 0,3080 | 0,0139 | 2,47 | 0,3520 | 0,0112 | 2,47 | 0,3520 | 0,0175 |
| S06- | Mürzzuschlag Ost | Mariazell, Mürzsteg, Mürzzuschlag | 1,09 | 0,1950 | 0,0034 | 1,09 | 0,1950 | 0,0054 | 1,52 | 0,2731 | 0,0079 | 1,53 | 0,2731 | 0,0123 | 2,19 | 0,3121 | 0,0099 | 2,19 | 0,3121 | 0,0156 |
| S06- | Mariazell, Mürzsteg, Mürzzuschlag | Hönigsberg | 0,78 | 0,1391 | 0,0024 | 0,78 | 0,1391 | 0,0038 | 1,09 | 0,1947 | 0,0056 | 1,09 | 0,1947 | 0,0088 | 1,56 | 0,2225 | 0,0071 | 1,56 | 0,2225 | 0,0111 |
| S06- | Hönigsberg | Langenwang | 0,43 | 0,0769 | 0,0013 | 0,43 | 0,0769 | 0,0021 | 0,60 | 0,1077 | 0,0031 | 0,60 | 0,1077 | 0,0049 | 0,86 | 0,1231 | 0,0039 | 0,87 | 0,1231 | 0,0061 |
| S06- | Langenwang | Krieglach | 0,51 | 0,0914 | 0,0016 | 0,51 | 0,0914 | 0,0025 | 0,71 | 0,1279 | 0,0037 | 0,72 | 0,1279 | 0,0058 | 1,02 | 0,1462 | 0,0046 | 1,03 | 0,1462 | 0,0073 |
| S06- | Krieglach | Mitterdorf | 1,29 | 0,2309 | 0,0040 | 1,29 | 0,2309 | 0,0064 | 1,81 | 0,3233 | 0,0093 | 1,81 | 0,3233 | 0,0146 | 2,59 | 0,3695 | 0,0117 | 2,60 | 0,3695 | 0,0184 |
| S06- | Mitterdorf | Kindberg Ost | 1,31 | 0,2348 | 0,0041 | 1,31 | 0,2348 | 0,0065 | 1,84 | 0,3287 | 0,0095 | 1,84 | 0,3287 | 0,0149 | 2,63 | 0,3757 | 0,0119 | 2,64 | 0,3757 | 0,0187 |
| S06- | Kindberg Ost | Kindberg West | 0,28 | 0,0504 | 0,0009 | 0,28 | 0,0504 | 0,0014 | 0,39 | 0,0706 | 0,0020 | 0,40 | 0,0706 | 0,0032 | 0,57 | 0,0806 | 0,0026 | 0,57 | 0,0806 | 0,0040 |
| S06- | Kindberg West | Kindberg Dörfel | 0,28 | 0,0504 | 0,0009 | 0,28 | 0,0504 | 0,0014 | 0,39 | 0,0705 | 0,0020 | 0,39 | 0,0705 | 0,0032 | 0,56 | 0,0806 | 0,0026 | 0,57 | 0,0806 | 0,0040 |
| S06- | Kindberg Dörfel | Allerheiligen Mürzhofen | 0,63 | 0,1134 | 0,0020 | 0,63 | 0,1134 | 0,0031 | 0,89 | 0,1588 | 0,0046 | 0,89 | 0,1588 | 0,0072 | 1,27 | 0,1815 | 0,0058 | 1,28 | 0,1815 | 0,0090 |
| S06- | Allerheiligen Mürzhofen | St. Marein | 0,95 | 0,1704 | 0,0030 | 0,95 | 0,1704 | 0,0047 | 1,33 | 0,2386 | 0,0069 | 1,34 | 0,2386 | 0,0108 | 1,91 | 0,2726 | 0,0086 | 1,92 | 0,2726 | 0,0136 |
| S06- | St. Marein | Kapfenberg | 0,67 | 0,1208 | 0,0021 | 0,67 | 0,1208 | 0,0033 | 0,94 | 0,1691 | 0,0049 | 0,95 | 0,1691 | 0,0076 | 1,35 | 0,1933 | 0,0061 | 1,36 | 0,1933 | 0,0096 |
| S06- | Kapfenberg | KN Bruck/Mur | 1,26 | 0,2255 | 0,0039 | 1,26 | 0,2255 | 0,0062 | 1,76 | 0,3157 | 0,0091 | 1,77 | 0,3157 | 0,0143 | 2,53 | 0,3608 | 0,0114 | 2,54 | 0,3608 | 0,0180 |
| S06- | KN Bruck/Mur | ASt Bruck/Mur | 1,08 | 0,1934 | 0,0034 | 1,08 | 0,1934 | 0,0053 | 1,51 | 0,2708 | 0,0078 | 1,52 | 0,2708 | 0,0122 | 2,17 | 0,3095 | 0,0098 | 2,18 | 0,3095 | 0,0154 |
| S06- | ASt Bruck/Mur | Niklasdorf | 1,00 | 0,1787 | 0,0031 | 1,00 | 0,1787 | 0,0049 | 1,40 | 0,2502 | 0,0072 | 1,40 | 0,2502 | 0,0113 | 2,00 | 0,2860 | 0,0091 | 2,01 | 0,2860 | 0,0143 |
| S06- | Niklasdorf | Leoben Ost | 1,06 | 0,1906 | 0,0033 | 1,06 | 0,1906 | 0,0052 | 1,49 | 0,2669 | 0,0077 | 1,49 | 0,2669 | 0,0121 | 2,14 | 0,3050 | 0,0097 | 2,14 | 0,3050 | 0,0152 |
| S06- | Leoben Ost | Leoben West | 1,19 | 0,2136 | 0,0037 | 1,19 | 0,2136 | 0,0059 | 1,67 | 0,2990 | 0,0086 | 1,67 | 0,2990 | 0,0135 | 2,40 | 0,3417 | 0,0108 | 2,40 | 0,3417</ | |

| | | | | | | | | | | | | | | | | | | | | |
|------|-----------------------------|-----------------------------|------|--------|--------|------|--------|--------|------|--------|--------|------|--------|--------|------|--------|----------|------|--------|--------|
| S31- | Eisenstadt Mitte | KN Eisenstadt | 0,42 | 0,0761 | 0,0013 | 0,42 | 0,0761 | 0,0021 | 0,59 | 0,1065 | 0,0031 | 0,60 | 0,1065 | 0,0048 | 0,85 | 0,1217 | 0,0039 | 0,86 | 0,1217 | 0,0061 |
| S31- | KN Eisenstadt | Wulkaprodersdorf | 0,56 | 0,1013 | 0,0018 | 0,57 | 0,1013 | 0,0028 | 0,79 | 0,1418 | 0,0041 | 0,79 | 0,1418 | 0,0064 | 1,14 | 0,1620 | 0,0051 | 1,14 | 0,1620 | 0,0081 |
| S31- | Wulkaprodersdorf | KN Mattersburg | 1,60 | 0,2875 | 0,0050 | 1,61 | 0,2875 | 0,0079 | 2,25 | 0,4025 | 0,0116 | 2,25 | 0,4025 | 0,0182 | 3,22 | 0,4600 | 0,0146 | 3,23 | 0,4600 | 0,0229 |
| S31- | KN Mattersburg | Forchtenstein | 1,16 | 0,2081 | 0,0036 | 1,16 | 0,2081 | 0,0057 | 1,63 | 0,2914 | 0,0084 | 1,63 | 0,2914 | 0,0132 | 2,33 | 0,3330 | 0,0106 | 2,34 | 0,3330 | 0,0166 |
| S31- | Forchtenstein | Sieggraben | 1,62 | 0,2908 | 0,0051 | 1,62 | 0,2908 | 0,0080 | 2,27 | 0,4071 | 0,0117 | 2,28 | 0,4071 | 0,0184 | 3,26 | 0,4653 | 0,0148 | 3,27 | 0,4653 | 0,0232 |
| S31- | Sieggraben | Weppersdorf/Kobersdorf | 1,95 | 0,3503 | 0,0061 | 1,96 | 0,3503 | 0,0096 | 2,74 | 0,4904 | 0,0141 | 2,75 | 0,4904 | 0,0222 | 3,93 | 0,5605 | 0,0178 | 3,94 | 0,5605 | 0,0279 |
| S31- | Weppersdorf/Kobersdorf | Weppersdorf/Markt St.Martin | 0,40 | 0,0720 | 0,0013 | 0,40 | 0,0720 | 0,0020 | 0,56 | 0,1007 | 0,0029 | 0,56 | 0,1007 | 0,0046 | 0,81 | 0,1151 | 0,0037 | 0,81 | 0,1151 | 0,0057 |
| S31- | Weppersdorf/Markt St.Martin | Neutal | 0,93 | 0,1663 | 0,0029 | 0,93 | 0,1663 | 0,0046 | 1,30 | 0,2328 | 0,0067 | 1,30 | 0,2328 | 0,0105 | 1,87 | 0,2660 | 0,0084 | 1,87 | 0,2660 | 0,0133 |
| S31- | Neutal | Stoob Süd | 0,81 | 0,1453 | 0,0025 | 0,81 | 0,1453 | 0,0040 | 1,14 | 0,2034 | 0,0058 | 1,14 | 0,2034 | 0,0092 | 1,63 | 0,2324 | 0,0074 | 1,63 | 0,2324 | 0,0116 |
| S31- | Stoob Süd | Oberpullendorf | 0,88 | 0,1586 | 0,0028 | 0,89 | 0,1586 | 0,0044 | 1,24 | 0,2220 | 0,0064 | 1,24 | 0,2220 | 0,0100 | 1,78 | 0,2538 | 0,0080 | 1,78 | 0,2538 | 0,0126 |
| S33- | KN St. Pölten | St. Pölten Ost | 0,48 | 0,0861 | 0,0015 | 0,48 | 0,0861 | 0,0024 | 0,67 | 0,1205 | 0,0035 | 0,67 | 0,1205 | 0,0054 | 0,97 | 0,1377 | 0,0044 | 0,97 | 0,1377 | 0,0069 |
| S33- | St. Pölten Ost | St. Pölten Nord | 0,85 | 0,1521 | 0,0027 | 0,85 | 0,1521 | 0,0042 | 1,19 | 0,2130 | 0,0061 | 1,19 | 0,2130 | 0,0096 | 1,71 | 0,2434 | 0,0077 | 1,71 | 0,2434 | 0,0121 |
| S33- | St. Pölten Nord | Herzogenburg Süd | 0,90 | 0,1611 | 0,0028 | 0,90 | 0,1611 | 0,0044 | 1,26 | 0,2255 | 0,0065 | 1,26 | 0,2255 | 0,0102 | 1,81 | 0,2577 | 0,0082 | 1,81 | 0,2577 | 0,0128 |
| S33- | Herzogenburg Süd | Herzogenburg Stadt | 0,48 | 0,0860 | 0,0015 | 0,48 | 0,0860 | 0,0024 | 0,67 | 0,1204 | 0,0035 | 0,67 | 0,1204 | 0,0054 | 0,96 | 0,1376 | 0,0044 | 0,97 | 0,1376 | 0,0069 |
| S33- | Herzogenburg Stadt | Herzogenburg Nord | 0,27 | 0,0477 | 0,0008 | 0,27 | 0,0477 | 0,0013 | 0,37 | 0,0668 | 0,0019 | 0,37 | 0,0668 | 0,0030 | 0,53 | 0,0763 | 0,0024 | 0,54 | 0,0763 | 0,0038 |
| S33- | Herzogenburg Nord | Traismauer Süd | 1,29 | 0,2320 | 0,0041 | 1,30 | 0,2320 | 0,0064 | 1,81 | 0,3249 | 0,0093 | 1,82 | 0,3249 | 0,0147 | 2,60 | 0,3713 | 0,0118 | 2,61 | 0,3713 | 0,0185 |
| S33- | Traismauer Süd | Traismauer Nord | 0,66 | 0,1180 | 0,0021 | 0,66 | 0,1180 | 0,0032 | 0,92 | 0,1652 | 0,0047 | 0,93 | 0,1652 | 0,0075 | 1,32 | 0,1888 | 0,0060 | 1,33 | 0,1888 | 0,0094 |
| S33- | Traismauer Nord | Jettsdorf | 1,11 | 0,1993 | 0,0035 | 1,11 | 0,1993 | 0,0055 | 1,56 | 0,2790 | 0,0080 | 1,56 | 0,2790 | 0,0126 | 2,24 | 0,3188 | 0,0101 | 2,24 | 0,3188 | 0,0159 |
| S35- | KN Bruck/Mur | Pernegg | 1,36 | 0,2436 | 0,0043 | 1,36 | 0,2436 | 0,0067 | 1,90 | 0,3410 | 0,0098 | 1,91 | 0,3410 | 0,0154 | 2,73 | 0,3898 | 0,0124 | 2,74 | 0,3898 | 0,0194 |
| S35- | Pernegg | Mixnitz/Mautstatt | 0,99 | 0,1772 | 0,0031 | 0,99 | 0,1772 | 0,0049 | 1,38 | 0,2480 | 0,0071 | 1,39 | 0,2480 | 0,0112 | 1,99 | 0,2835 | 0,0090 | 1,99 | 0,2835 | 0,0141 |
| S35- | Mixnitz/Mautstatt | Röthelstein | 1,18 | 0,2124 | 0,0037 | 1,19 | 0,2124 | 0,0058 | 1,66 | 0,2974 | 0,0085 | 1,67 | 0,2974 | 0,0134 | 2,38 | 0,3398 | 0,0108 | 2,39 | 0,3398 | 0,0169 |
| S35- | Röthelstein | Laufnitzdorf | 0,57 | 0,1024 | 0,0018 | 0,57 | 0,1024 | 0,0028 | 0,80 | 0,1433 | 0,0041 | 0,80 | 0,1433 | 0,0065 | 1,15 | 0,1638 | 0,0052 | 1,15 | 0,1638 | 0,0082 |
| S35- | Laufnitzdorf | Rothleiten | 0,65 | 0,1164 | 0,0020 | 0,65 | 0,1164 | 0,0032 | 0,91 | 0,1629 | 0,0047 | 0,91 | 0,1629 | 0,0074 | 1,31 | 0,1862 | 0,0059 | 1,31 | 0,1862 | 0,0093 |
| S35- | Rothleiten | Frohnleiten Nord | 0,40 | 0,0725 | 0,0013 | 0,40 | 0,0725 | 0,0020 | 0,57 | 0,1015 | 0,0029 | 0,57 | 0,1015 | 0,0046 | 0,81 | 0,1160 | 0,0037 | 0,82 | 0,1160 | 0,0058 |
| S35- | Frohnleiten Nord | Frohnleiten | 0,19 | 0,0334 | 0,0006 | 0,19 | 0,0334 | 0,0009 | 0,26 | 0,0468 | 0,0013 | 0,26 | 0,0468 | 0,0021 | 0,38 | 0,0535 | 0,0017 | 0,38 | 0,0535 | 0,0027 |
| S35- | Frohnleiten | Badl Peggau | 1,25 | 0,2248 | 0,0039 | 1,26 | 0,2248 | 0,0062 | 1,76 | 0,3147 | 0,0090 | 1,76 | 0,3147 | 0,0142 | 2,52 | 0,3597 | 0,0114 | 2,53 | 0,3597 | 0,0179 |
| S35- | Badl Peggau | Peggau Mitte | 0,42 | 0,0752 | 0,0013 | 0,42 | 0,0752 | 0,0021 | 0,59 | 0,1053 | 0,0030 | 0,59 | 0,1053 | 0,0048 | 0,84 | 0,1203 | 0,0038 | 0,85 | 0,1203 | 0,0060 |
| S35- | Peggau Mitte | KN Peggau Deutschfeistritz | 0,87 | 0,1566 | 0,0027 | 0,87 | 0,1566 | 0,0043 | 1,22 | 0,2192 | 0,0063 | 1,23 | 0,2192 | 0,0099 | 1,76 | 0,2506 | 0,0079 | 1,76 | 0,2506 | 0,0125 |
| S36- | KN St. Michael | St. Stefan ob Leoben | 0,72 | 0,1290 | 0,0023 | 0,72 | 0,1290 | 0,0035 | 1,01 | 0,1806 | 0,0052 | 1,01 | 0,1806 | 0,0082 | 1,45 | 0,2064 | 0,0065 | 1,45 | 0,2064 | 0,0103 |
| S36- | St. Stefan ob Leoben | Kraubath | 0,77 | 0,1386 | 0,0024 | 0,77 | 0,1386 | 0,0038 | 1,08 | 0,1940 | 0,0056 | 1,09 | 0,1940 | 0,0088 | 1,55 | 0,2218 | 0,0070 | 1,56 | 0,2218 | 0,0111 |
| S36- | Kraubath | Feistritz St. Lorenzen | 1,36 | 0,2435 | 0,0043 | 1,36 | 0,2435 | 0,0067 | 1,90 | 0,3409 | 0,0098 | 1,91 | 0,3409 | 0,0154 | 2,73 | 0,3896 | 0,0124 | 2,74 | 0,3896 | 0,0194 |
| S36- | Feistritz St. Lorenzen | Knittelfeld Ost | 1,56 | 0,2795 | 0,0049 | 1,56 | 0,2795 | 0,0077 | 2,18 | 0,3913 | 0,0112 | 2,19 | 0,3913 | 0,0177 | 3,13 | 0,4472 | 0,0142 | 3,14 | 0,4472 | 0,0223 |
| S36- | Knittelfeld Ost | Knittelfeld West | 0,66 | 0,1185 | 0,0021 | 0,66 | 0,1185 | 0,0033 | 0,93 | 0,1659 | 0,0048 | 0,93 | 0,1659 | 0,0075 | 1,33 | 0,1896 | 0,0060 | 1,33 | 0,1896 | 0,0095 |
| S36- | Knittelfeld West | Zeitweg Ost Spielberg | 0,21 | 0,0370 | 0,0006 | 0,21 | 0,0370 | 0,0010 | 0,29 | 0,0518 | 0,0015 | 0,29 | 0,0518 | 0,0023 | 0,42 | 0,0592 | 0,0019 | 0,42 | 0,0592 | 0,0030 |
| S36- | Zeitweg Ost Spielberg | Zeitweg West | 1,34 | 0,2408 | 0,0042 | 1,34 | 0,2408 | 0,0066 | 1,88 | 0,3371 | 0,0097 | 1,89 | 0,3371 | 0,0152 | 2,70 | 0,3853 | 0,0122 | 2,71 | 0,3853 | 0,0192 |
| S36- | Zeitweg West | Judenburg Ost Fohnsdorf | 0,67 | 0,1211 | 0,0021 | 0,68 | 0,1211 | 0,0033 | 0,95 | 0,1695 | 0,0049 | 0,95 | 0,1695 | 0,0077 | 1,36 | 0,1937 | 0,0061 | 1,36 | 0,1937 | 0,0097 |
| S36- | Judenburg Ost Fohnsdorf | Judenburg West | 1,05 | 0,1878 | 0,0033 | 1,05 | 0,1878 | 0,0052 | 1,47 | 0,2630 | 0,0076 | 1,47 | 0,2630 | 0,0119 | 2,11 | 0,3005 | 0,0095 | 2,11 | 0,3005 | 0,0150 |
| S36- | As B317 (prov.) | St. Georgen Ost | 0,11 | 0,0196 | 0,0003 | 0,11 | 0,0196 | 0,0005 | 0,15 | 0,0275 | 0,0008 | 0,15 | 0,0275 | 0,0012 | 0,22 | 0,0314 | 0,0010 | 0,22 | 0,0314 | 0,0016 |
| S36- | St. Georgen Ost | St. Georgen West | 0,20 | 0,0364 | 0,0006 | 0,20 | 0,0364 | 0,0010 | 0,28 | 0,0509 | 0,0015 | 0,29 | 0,0509 | 0,0023 | 0,41 | 0,0582 | 0,0018 | 0,41 | 0,0582 | 0,0029 |
| S37- | St. Veit Nord | St. Veit Mitte / Brückl | 0,63 | 0,1139 | 0,0020 | 0,64 | 0,1139 | 0,0031 | 0,89 | 0,1595 | 0,0046 | 0,89 | 0,1595 | 0,0072 | 1,28 | 0,1823 | 0,0058 | 1,28 | 0,1823 | 0,0091 |
| S37- | St. Veit Mitte / Brückl | St. Veit Süd | 0,54 | 0,0968 | 0,0017 | 0,54 | 0,0968 | 0,0027 | 0,76 | 0,1356 | 0,0039 | 0,76 | 0,1356 | 0,0061 | 1,09 | 0,1549 | 0,0049 | 1,09 | 0,1549 | 0,0077 |
| S37- | St. Veit Süd | St. Veit Industriegebiet | 0,41 | 0,0728 | 0,0013 | 0,41 | 0,0728 | 0,0020 | 0,57 | 0,1019 | 0,0029 | 0,57 | 0,1019 | 0,0046 | 0,82 | 0,1165 | 0,0037 | 0,82 | 0,1165 | 0,0058 |
| S37- | St. Veit Industriegebiet | Maria Saal | 1,42 | 0,2555 | 0,0045 | 1,43 | 0,2555 | 0,0070 | 2,00 | 0,3577 | 0,0103 | 2,00 | 0,3577 | 0,0162 | 2,87 | 0,4088 | 0,0130 | 2,87 | 0,4088 | 0,0204 |
| S37- | Maria Saal | Karnburg | 0,51 | 0,0912 | 0,0016 | 0,51 | 0,0912 | 0,0025 | 0,71 | 0,1277 | 0,0037 | 0,72 | 0,1277 | 0,0058 | 1,02 | 0,1460 | 0,0046 | 1,03 | 0,1460 | 0,0073 |
| S37- | Karnburg | Klagenfurt Nord | 0,44 | 0,0796 | 0,0014 | 0,44 | 0,0796 | 0,0022 | 0,62 | 0,1115 | 0,0032 | 0,62 | 0,1115 | 0,0050 | 0,89 | 0,1274 | 0,0040 | 0,90 | 0,1274 | 0,0064 |
| A01- | Preßbaum | Wien Auhof | 3,11 | 0,5572 | 0,0098 | 3,11 | 0,5572 | 0,0153 | 4,36 | 0,7801 | 0,0224 | 4,37 | 0,7801 | 0,0352 | 6,25 | 0,8915 | 0,0283 | 6,27 | 0,8915 | 0,0444 |
| A01- | KN Steinhäusl | Preßbaum | 1,75 | 0,3149 | 0,0055 | 1,76 | 0,3149 | 0,0087 | 2,46 | 0,4408 | 0,0127 | 2,47 | 0,4408 | 0,0199 | 3,53 | 0,5038 | 0,0160 | 3,54 | 0,5038 | 0,0251 |
| A01- | Alltengbach | KN Steinhäusl | 1,03 | 0,1851 | 0,0032 | 1,03 | 0,1851 | 0,0051 | 1,45 | 0,2592 | 0,0075 | 1,45 | 0,2592 | 0,0117 | 2,08 | 0,2962 | 0,0094 | 2,08 | 0,2962 | 0,0148 |
| A01- | St. Christophen | Alltengbach | 1,23 | 0,2208 | 0,0039 | 1,23 | 0,2208 | 0,0061 | 1,73 | 0,3091 | 0,0089 | 1,73 | 0,3091 | 0,0140 | 2,48 | 0,3532 | 0,0112 | 2,48 | 0,3532 | 0,0176 |
| A01- | Böheimkirchen | St. Christophen | 1,48 | 0,2648 | 0,0046 | 1,48 | 0,2648 | 0,0073 | 2,07 | 0,3707 | 0,0107 | 2,08 | 0,3707 | 0,0167 | 2,97 | 0,4236 | 0,0134 | 2,98 | 0,4236 | 0,0211 |
| A01- | KN St. Pölten | Böheimkirchen | 1,44 | 0,2590 | 0,0045 | 1,45 | 0,2590 | 0,0071 | 2,02 | 0,3626 | 0,0104 | 2,03 | 0,3626 | 0,0164 | 2,91 | 0,4144 | 0,0131</ | | | |

| | | | | | | | | | | | | | | | | | | | | |
|------|----------------------------|----------------------------|------|--------|--------|------|--------|--------|------|--------|--------|------|--------|--------|------|--------|--------|------|--------|--------|
| A01- | Laakirchen West | Laakirchen Ost | 0,81 | 0,1448 | 0,0025 | 0,81 | 0,1448 | 0,0040 | 1,13 | 0,2027 | 0,0058 | 1,14 | 0,2027 | 0,0092 | 1,62 | 0,2317 | 0,0073 | 1,63 | 0,2317 | 0,0115 |
| A01- | Regau | Laakirchen West | 1,58 | 0,2838 | 0,0050 | 1,58 | 0,2838 | 0,0078 | 2,22 | 0,3974 | 0,0114 | 2,23 | 0,3974 | 0,0180 | 3,18 | 0,4541 | 0,0144 | 3,19 | 0,4541 | 0,0226 |
| A01- | Schörfling | Regau | 2,08 | 0,3730 | 0,0065 | 2,08 | 0,3730 | 0,0103 | 2,92 | 0,5221 | 0,0150 | 2,92 | 0,5221 | 0,0236 | 4,18 | 0,5967 | 0,0189 | 4,19 | 0,5967 | 0,0297 |
| A01- | Seewalchen | Schörfling | 0,32 | 0,0578 | 0,0010 | 0,32 | 0,0578 | 0,0016 | 0,45 | 0,0809 | 0,0023 | 0,45 | 0,0809 | 0,0037 | 0,65 | 0,0925 | 0,0029 | 0,65 | 0,0925 | 0,0046 |
| A01- | St. Georgen | Seewalchen | 1,88 | 0,3381 | 0,0059 | 1,89 | 0,3381 | 0,0093 | 2,64 | 0,4733 | 0,0136 | 2,65 | 0,4733 | 0,0214 | 3,79 | 0,5409 | 0,0172 | 3,80 | 0,5409 | 0,0270 |
| A01- | Oberwang | St. Georgen | 2,51 | 0,4508 | 0,0079 | 2,52 | 0,4508 | 0,0124 | 3,52 | 0,6311 | 0,0181 | 3,53 | 0,6311 | 0,0285 | 5,06 | 0,7213 | 0,0229 | 5,07 | 0,7213 | 0,0360 |
| A01- | Mondsee | Oberwang | 2,31 | 0,4149 | 0,0073 | 2,32 | 0,4149 | 0,0114 | 3,24 | 0,5809 | 0,0167 | 3,25 | 0,5809 | 0,0262 | 4,65 | 0,6639 | 0,0211 | 4,67 | 0,6639 | 0,0331 |
| A01- | Thalgau | Mondsee | 2,13 | 0,3825 | 0,0067 | 2,14 | 0,3825 | 0,0105 | 2,99 | 0,5355 | 0,0154 | 3,00 | 0,5355 | 0,0242 | 4,29 | 0,6120 | 0,0194 | 4,30 | 0,6120 | 0,0305 |
| A01- | Wallersee | Thalgau | 1,62 | 0,2915 | 0,0051 | 1,63 | 0,2915 | 0,0080 | 2,28 | 0,4081 | 0,0117 | 2,29 | 0,4081 | 0,0184 | 3,27 | 0,4664 | 0,0148 | 3,28 | 0,4664 | 0,0232 |
| A01- | Salzburg Nord | Wallersee | 1,57 | 0,2822 | 0,0049 | 1,58 | 0,2822 | 0,0078 | 2,21 | 0,3950 | 0,0114 | 2,21 | 0,3950 | 0,0178 | 3,16 | 0,4515 | 0,0143 | 3,17 | 0,4515 | 0,0225 |
| A01- | Salzburg Bergheim-West | Salzburg Nord | 0,35 | 0,0636 | 0,0011 | 0,36 | 0,0636 | 0,0017 | 0,50 | 0,0890 | 0,0026 | 0,50 | 0,0890 | 0,0040 | 0,71 | 0,1018 | 0,0032 | 0,72 | 0,1018 | 0,0051 |
| A01- | Messe | Salzburg Bergheim-West | 0,17 | 0,0304 | 0,0005 | 0,17 | 0,0304 | 0,0008 | 0,24 | 0,0426 | 0,0012 | 0,24 | 0,0426 | 0,0019 | 0,34 | 0,0487 | 0,0015 | 0,34 | 0,0487 | 0,0024 |
| A01- | Salzburg Mitte Freilassing | Messe | 0,23 | 0,0405 | 0,0007 | 0,23 | 0,0405 | 0,0011 | 0,32 | 0,0567 | 0,0016 | 0,32 | 0,0567 | 0,0026 | 0,45 | 0,0648 | 0,0021 | 0,46 | 0,0648 | 0,0032 |
| A01- | Kleßheim | Salzburg Mitte Freilassing | 0,28 | 0,0497 | 0,0009 | 0,28 | 0,0497 | 0,0014 | 0,39 | 0,0696 | 0,0020 | 0,39 | 0,0696 | 0,0031 | 0,56 | 0,0796 | 0,0025 | 0,56 | 0,0796 | 0,0040 |
| A01- | Siezenheim | Kleßheim | 0,38 | 0,0689 | 0,0012 | 0,38 | 0,0689 | 0,0019 | 0,54 | 0,0965 | 0,0028 | 0,54 | 0,0965 | 0,0044 | 0,77 | 0,1103 | 0,0035 | 0,78 | 0,1103 | 0,0055 |
| A01- | Flughafen | Siezenheim | 0,19 | 0,0346 | 0,0006 | 0,19 | 0,0346 | 0,0010 | 0,27 | 0,0485 | 0,0014 | 0,27 | 0,0485 | 0,0022 | 0,39 | 0,0554 | 0,0018 | 0,39 | 0,0554 | 0,0028 |
| A01- | Wals Salzburg West | Flughafen | 0,24 | 0,0424 | 0,0007 | 0,24 | 0,0424 | 0,0012 | 0,33 | 0,0593 | 0,0017 | 0,33 | 0,0593 | 0,0027 | 0,48 | 0,0678 | 0,0021 | 0,48 | 0,0678 | 0,0034 |
| A01- | KN Salzburg | Wals Salzburg West | 0,35 | 0,0634 | 0,0011 | 0,35 | 0,0634 | 0,0017 | 0,50 | 0,0888 | 0,0026 | 0,50 | 0,0888 | 0,0040 | 0,71 | 0,1014 | 0,0032 | 0,71 | 0,1014 | 0,0051 |
| A01- | Staatsgrenze Walsberg | KN Salzburg | 0,60 | 0,1077 | 0,0019 | 0,60 | 0,1077 | 0,0030 | 0,84 | 0,1508 | 0,0043 | 0,84 | 0,1508 | 0,0068 | 1,21 | 0,1724 | 0,0055 | 1,21 | 0,1724 | 0,0086 |
| A02- | KN Vösendorf | KN Wien Inzersdorf | 0,75 | 0,1348 | 0,0024 | 0,75 | 0,1348 | 0,0037 | 1,05 | 0,1887 | 0,0054 | 1,06 | 0,1887 | 0,0085 | 1,51 | 0,2157 | 0,0068 | 1,52 | 0,2157 | 0,0108 |
| A02- | Mödling | KN Vösendorf | 0,51 | 0,0916 | 0,0016 | 0,51 | 0,0916 | 0,0025 | 0,72 | 0,1283 | 0,0037 | 0,72 | 0,1283 | 0,0058 | 1,03 | 0,1466 | 0,0047 | 1,03 | 0,1466 | 0,0073 |
| A02- | Wr. Neudorf | Mödling | 0,49 | 0,0874 | 0,0015 | 0,49 | 0,0874 | 0,0024 | 0,68 | 0,1224 | 0,0035 | 0,69 | 0,1224 | 0,0055 | 0,98 | 0,1399 | 0,0044 | 0,98 | 0,1399 | 0,0070 |
| A02- | Wr. Neudorf IZ/Süd | Wr. Neudorf | 0,54 | 0,0962 | 0,0017 | 0,54 | 0,0962 | 0,0026 | 0,75 | 0,1347 | 0,0039 | 0,75 | 0,1347 | 0,0061 | 1,08 | 0,1539 | 0,0049 | 1,08 | 0,1539 | 0,0077 |
| A02- | KN Guntramsdorf | Wr. Neudorf IZ/Süd | 0,78 | 0,1402 | 0,0025 | 0,78 | 0,1402 | 0,0039 | 1,10 | 0,1963 | 0,0056 | 1,10 | 0,1963 | 0,0089 | 1,57 | 0,2244 | 0,0071 | 1,58 | 0,2244 | 0,0112 |
| A02- | Traiskirchen | KN Guntramsdorf | 0,87 | 0,1562 | 0,0027 | 0,87 | 0,1562 | 0,0043 | 1,22 | 0,2186 | 0,0063 | 1,22 | 0,2186 | 0,0099 | 1,75 | 0,2499 | 0,0079 | 1,76 | 0,2499 | 0,0125 |
| A02- | Baden | Traiskirchen | 0,48 | 0,0869 | 0,0015 | 0,49 | 0,0869 | 0,0024 | 0,68 | 0,1217 | 0,0035 | 0,68 | 0,1217 | 0,0055 | 0,97 | 0,1391 | 0,0044 | 0,98 | 0,1391 | 0,0069 |
| A02- | Bad Vöslau | Baden | 0,80 | 0,1428 | 0,0025 | 0,80 | 0,1428 | 0,0039 | 1,12 | 0,1999 | 0,0057 | 1,12 | 0,1999 | 0,0090 | 1,60 | 0,2285 | 0,0072 | 1,61 | 0,2285 | 0,0114 |
| A02- | Kottingbrunn | Bad Vöslau | 0,57 | 0,1031 | 0,0018 | 0,58 | 0,1031 | 0,0028 | 0,81 | 0,1444 | 0,0042 | 0,81 | 0,1444 | 0,0065 | 1,16 | 0,1650 | 0,0052 | 1,16 | 0,1650 | 0,0082 |
| A02- | Leobersdorf | Kottingbrunn | 0,50 | 0,0905 | 0,0016 | 0,51 | 0,0905 | 0,0025 | 0,71 | 0,1267 | 0,0036 | 0,71 | 0,1267 | 0,0057 | 1,01 | 0,1448 | 0,0046 | 1,02 | 0,1448 | 0,0072 |
| A02- | Wöllersdorf | Leobersdorf | 2,01 | 0,3610 | 0,0063 | 2,02 | 0,3610 | 0,0099 | 2,82 | 0,5054 | 0,0145 | 2,83 | 0,5054 | 0,0228 | 4,05 | 0,5776 | 0,0183 | 4,06 | 0,5776 | 0,0288 |
| A02- | Wr. Neustadt West | Wöllersdorf | 1,31 | 0,2345 | 0,0041 | 1,31 | 0,2345 | 0,0064 | 1,83 | 0,3283 | 0,0094 | 1,84 | 0,3283 | 0,0148 | 2,63 | 0,3752 | 0,0119 | 2,64 | 0,3752 | 0,0187 |
| A02- | KN Wr. Neustadt | Wr. Neustadt West | 0,52 | 0,0939 | 0,0016 | 0,52 | 0,0939 | 0,0026 | 0,73 | 0,1314 | 0,0038 | 0,74 | 0,1314 | 0,0059 | 1,05 | 0,1502 | 0,0048 | 1,06 | 0,1502 | 0,0075 |
| A02- | KN Seebenstein | KN Wr. Neustadt | 2,37 | 0,4248 | 0,0074 | 2,37 | 0,4248 | 0,0117 | 3,32 | 0,5947 | 0,0171 | 3,33 | 0,5947 | 0,0269 | 4,76 | 0,6797 | 0,0216 | 4,78 | 0,6797 | 0,0339 |
| A02- | Grimmenstein | KN Seebenstein | 2,02 | 0,3624 | 0,0063 | 2,02 | 0,3624 | 0,0100 | 2,83 | 0,5073 | 0,0146 | 2,84 | 0,5073 | 0,0229 | 4,06 | 0,5798 | 0,0184 | 4,07 | 0,5798 | 0,0289 |
| A02- | Edlitz | Grimmenstein | 0,56 | 0,1003 | 0,0018 | 0,56 | 0,1003 | 0,0028 | 0,78 | 0,1404 | 0,0040 | 0,79 | 0,1404 | 0,0063 | 1,13 | 0,1605 | 0,0051 | 1,13 | 0,1605 | 0,0080 |
| A02- | Krumbach | Edlitz | 1,73 | 0,3098 | 0,0054 | 1,73 | 0,3098 | 0,0085 | 2,42 | 0,4337 | 0,0125 | 2,43 | 0,4337 | 0,0196 | 3,47 | 0,4957 | 0,0157 | 3,48 | 0,4957 | 0,0247 |
| A02- | Zöbern | Krumbach | 0,91 | 0,1635 | 0,0029 | 0,91 | 0,1635 | 0,0045 | 1,28 | 0,2289 | 0,0066 | 1,28 | 0,2289 | 0,0103 | 1,83 | 0,2616 | 0,0083 | 1,84 | 0,2616 | 0,0130 |
| A02- | Aspang | Zöbern | 0,12 | 0,0214 | 0,0004 | 0,12 | 0,0214 | 0,0006 | 0,17 | 0,0299 | 0,0009 | 0,17 | 0,0299 | 0,0014 | 0,24 | 0,0342 | 0,0011 | 0,24 | 0,0342 | 0,0017 |
| A02- | Schäftern | Aspang | 1,44 | 0,2588 | 0,0045 | 1,44 | 0,2588 | 0,0071 | 2,02 | 0,3623 | 0,0104 | 2,03 | 0,3623 | 0,0164 | 2,90 | 0,4140 | 0,0131 | 2,91 | 0,4140 | 0,0206 |
| A02- | Pinggau/Friedberg | Schäftern | 1,72 | 0,3091 | 0,0054 | 1,73 | 0,3091 | 0,0085 | 2,42 | 0,4327 | 0,0124 | 2,42 | 0,4327 | 0,0195 | 3,47 | 0,4945 | 0,0157 | 3,48 | 0,4945 | 0,0246 |
| A02- | Pinkafeld | Pinggau/Friedberg | 1,17 | 0,2094 | 0,0037 | 1,17 | 0,2094 | 0,0058 | 1,64 | 0,2931 | 0,0084 | 1,64 | 0,2931 | 0,0132 | 2,35 | 0,3350 | 0,0106 | 2,35 | 0,3350 | 0,0167 |
| A02- | Lafnitzal/Oberwart | Pinkafeld | 2,43 | 0,4364 | 0,0076 | 2,44 | 0,4364 | 0,0120 | 3,41 | 0,6110 | 0,0176 | 3,42 | 0,6110 | 0,0276 | 4,90 | 0,6983 | 0,0221 | 4,91 | 0,6983 | 0,0348 |
| A02- | Hartberg | Lafnitzal/Oberwart | 0,96 | 0,1723 | 0,0030 | 0,96 | 0,1723 | 0,0047 | 1,35 | 0,2412 | 0,0069 | 1,35 | 0,2412 | 0,0109 | 1,93 | 0,2756 | 0,0087 | 1,94 | 0,2756 | 0,0137 |
| A02- | Sebersdorf/Bad Waltersdorf | Hartberg | 2,43 | 0,4359 | 0,0076 | 2,43 | 0,4359 | 0,0120 | 3,41 | 0,6103 | 0,0175 | 3,42 | 0,6103 | 0,0276 | 4,89 | 0,6975 | 0,0221 | 4,90 | 0,6975 | 0,0348 |
| A02- | Ilz Fürstenfeld | Sebersdorf/Bad Waltersdorf | 2,72 | 0,4888 | 0,0086 | 2,73 | 0,4888 | 0,0134 | 3,82 | 0,6843 | 0,0197 | 3,83 | 0,6843 | 0,0309 | 5,48 | 0,7820 | 0,0248 | 5,50 | 0,7820 | 0,0390 |
| A02- | Sinabelkirchen | Ilz Fürstenfeld | 2,50 | 0,4493 | 0,0079 | 2,51 | 0,4493 | 0,0124 | 3,51 | 0,6290 | 0,0181 | 3,52 | 0,6290 | 0,0284 | 5,04 | 0,7189 | 0,0228 | 5,05 | 0,7189 | 0,0358 |
| A02- | Gleisdorf Süd | Sinabelkirchen | 1,65 | 0,2960 | 0,0052 | 1,65 | 0,2960 | 0,0081 | 2,31 | 0,4144 | 0,0119 | 2,32 | 0,4144 | 0,0187 | 3,32 | 0,4736 | 0,0150 | 3,33 | 0,4736 | 0,0236 |
| A02- | Gleisdorf West | Gleisdorf Süd | 0,72 | 0,1285 | 0,0022 | 0,72 | 0,1285 | 0,0035 | 1,00 | 0,1799 | 0,0052 | 1,01 | 0,1799 | 0,0081 | 1,44 | 0,2056 | 0,0065 | 1,44 | 0,2056 | 0,0102 |
| A02- | Laßnitzhöhe | Gleisdorf West | 1,88 | 0,3366 | 0,0059 | 1,88 | 0,3366 | 0,0093 | 2,63 | 0,4713 | 0,0135 | 2,64 | 0,4713 | 0,0213 | 3,78 | 0,5386 | 0,0171 | 3,79 | 0,5386 | 0,0268 |
| A02- | KN Graz Ost | Laßnitzhöhe | 2,35 | 0,4212 | 0,0074 | 2,35 | 0,4212 | 0,0116 | 3,29 | 0,5896 | 0,0170 | 3,30 | 0,5896 | 0,0266 | 4,72 | 0,6739 | 0,0214 | 4,74 | 0,6739 | 0,0336 |
| A02- | Graz Feldkirchen Flughafen | KN Graz Ost | 0,84 | 0,1515 | 0,0027 | 0,85 | 0,1515 | 0,0042 | 1,18 | 0,2121 | 0,0061 | 1,19 | 0,2121 | 0,0096 | 1,70 | 0,2424 | 0,0077 | 1,70 | 0,2424 | 0,0121 |
| A02- | KN Graz West | Graz Feldkirchen Flughafen | 0,57 | 0,1014 | 0,0018 | 0,57 | 0,1014 | 0,0028 | 0,79 | 0,1420 | 0,0041 | 0,80 | 0,1420 | 0,0064 | 1,14 | 0,1623 | 0,0051 | 1,14 | 0,1623 | 0,0081 |
| A02- | Unterpremstätten | KN Graz West | 0,68 | 0,1220 | 0,0021 | 0,68 | 0,1220 | 0,0034 | 0,95 | 0,1707 | 0,0049 | 0,96 | 0,1707 | 0,0077 | 1,37 | 0,1951 | 0,0062 | 1,37 | 0,1951 | 0,0097 |
| A02- | Lieboch | Unterpremstätten | 1,06 | 0,1894 | 0,0033 | 1,06 | 0,1894 | 0,0052 | 1,48 | 0,2652 | 0,0076 | 1,49 | 0,2652 | 0,0120 | 2,12 | 0,3030 | 0,0096 | 2,13 | 0,3030 | 0,0151 |
| A02- | Mooskirchen | Lieboch | 1,46 | 0,2612 | 0,0046 | 1,46 | 0,2612 | 0,0072 | 2,04 | 0,3656 | 0,0105 | 2,05 | 0,3656 | 0,0165 | 2,93 | 0,4179 | 0,0133 | 2,94 | 0,4179 | 0,0208 |
| A02- | Steinberg | Mooskirchen | 1,51 | 0,2703 | 0,0047 | 1,51 | 0,2703 | 0,0074 | 2,11 | 0,3784 | 0,0109 | 2,12 | 0,3784 | 0,0171 | 3,03 | 0,4324 | 0,0137 | 3,04 | 0,4324 | 0,0216 |
| A02- | Modriach | Steinberg | 3,76 | 0,6756 | 0,0118 | 3,77 | 0,6756 | 0,0186 | 5,28 | 0,9458 | 0,0272 | 5,30 | | | | | | | | |

| | | | | | | | | | | | | | | | | | | | | |
|------|----------------------------------|----------------------------------|------|--------|--------|------|----------|--------|------|--------|--------|------|--------|--------|------|--------|--------|------|--------|--------|
| A02- | Velden West | Velden Ost | 0,83 | 0,1493 | 0,0026 | 0,83 | 0,1493 | 0,0041 | 1,17 | 0,2090 | 0,0060 | 1,17 | 0,2090 | 0,0094 | 1,67 | 0,2389 | 0,0076 | 1,68 | 0,2389 | 0,0119 |
| A02- | Wernberg | Velden West | 1,38 | 0,2468 | 0,0043 | 1,38 | 0,2468 | 0,0068 | 1,93 | 0,3455 | 0,0099 | 1,93 | 0,3455 | 0,0156 | 2,77 | 0,3949 | 0,0125 | 2,78 | 0,3949 | 0,0197 |
| A02- | KN Villach | Wernberg | 0,73 | 0,1312 | 0,0023 | 0,73 | 0,1312 | 0,0036 | 1,03 | 0,1837 | 0,0053 | 1,03 | 0,1837 | 0,0083 | 1,47 | 0,2099 | 0,0067 | 1,48 | 0,2099 | 0,0105 |
| A02- | Villach Faaker See | KN Villach | 0,57 | 0,1020 | 0,0018 | 0,57 | 0,1020 | 0,0028 | 0,80 | 0,1428 | 0,0041 | 0,80 | 0,1428 | 0,0065 | 1,14 | 0,1632 | 0,0052 | 1,15 | 0,1632 | 0,0081 |
| A02- | Villach Warmbad | Villach Faaker See | 1,30 | 0,2330 | 0,0041 | 1,30 | 0,2330 | 0,0064 | 1,82 | 0,3262 | 0,0094 | 1,83 | 0,3262 | 0,0147 | 2,61 | 0,3728 | 0,0118 | 2,62 | 0,3728 | 0,0186 |
| A02- | Hermagor | Villach Warmbad | 2,35 | 0,4224 | 0,0074 | 2,36 | 0,4224 | 0,0116 | 3,30 | 0,5914 | 0,0170 | 3,31 | 0,5914 | 0,0267 | 4,74 | 0,6758 | 0,0214 | 4,75 | 0,6758 | 0,0337 |
| A02- | Arnoldstein | Hermagor | 0,56 | 0,1006 | 0,0018 | 0,56 | 0,1006 | 0,0028 | 0,79 | 0,1408 | 0,0040 | 0,79 | 0,1408 | 0,0064 | 1,13 | 0,1610 | 0,0051 | 1,13 | 0,1610 | 0,0080 |
| A02- | Staatsgrenze Arnoldstein | Arnoldstein | 0,86 | 0,1542 | 0,0027 | 0,86 | 0,1542 | 0,0042 | 1,21 | 0,2159 | 0,0062 | 1,21 | 0,2159 | 0,0098 | 1,73 | 0,2468 | 0,0078 | 1,73 | 0,2468 | 0,0123 |
| A03- | Münchendorf/Achau | KN Guntramsdorf | 0,22 | 0,0400 | 0,0007 | 0,22 | 0,0400 | 0,0011 | 0,31 | 0,0561 | 0,0016 | 0,31 | 0,0561 | 0,0025 | 0,45 | 0,0641 | 0,0020 | 0,45 | 0,0641 | 0,0032 |
| A03- | Ebreichsdorf Nord | Münchendorf/Achau | 0,94 | 0,1686 | 0,0029 | 0,94 | 0,1686 | 0,0046 | 1,32 | 0,2360 | 0,0068 | 1,32 | 0,2360 | 0,0107 | 1,89 | 0,2697 | 0,0086 | 1,90 | 0,2697 | 0,0134 |
| A03- | Ebreichsdorf West | Ebreichsdorf Nord | 0,77 | 0,1376 | 0,0024 | 0,77 | 0,1376 | 0,0038 | 1,08 | 0,1926 | 0,0055 | 1,08 | 0,1926 | 0,0087 | 1,54 | 0,2202 | 0,0070 | 1,55 | 0,2202 | 0,0110 |
| A03- | Pottendorf | Ebreichsdorf West | 1,01 | 0,1805 | 0,0032 | 1,01 | 0,1805 | 0,0050 | 1,41 | 0,2527 | 0,0073 | 1,42 | 0,2527 | 0,0114 | 2,02 | 0,2888 | 0,0092 | 2,03 | 0,2888 | 0,0144 |
| A03- | Hornstein | Pottendorf | 1,65 | 0,2964 | 0,0052 | 1,65 | 0,2964 | 0,0082 | 2,32 | 0,4150 | 0,0119 | 2,32 | 0,4150 | 0,0187 | 3,32 | 0,4742 | 0,0150 | 3,33 | 0,4742 | 0,0236 |
| A03- | Müllendorf | Hornstein | 1,08 | 0,1942 | 0,0034 | 1,08 | 0,1942 | 0,0053 | 1,52 | 0,2719 | 0,0078 | 1,52 | 0,2719 | 0,0123 | 2,18 | 0,3108 | 0,0099 | 2,18 | 0,3108 | 0,0155 |
| A03- | KN Eisenstadt | Müllendorf | 0,90 | 0,1624 | 0,0028 | 0,91 | 0,1624 | 0,0045 | 1,27 | 0,2273 | 0,0065 | 1,27 | 0,2273 | 0,0103 | 1,82 | 0,2598 | 0,0082 | 1,83 | 0,2598 | 0,0129 |
| A031 | Siegersdorf | KN Eisenstadt | 0,71 | 0,1280 | 0,0022 | 0,71 | 0,1280 | 0,0035 | 1,00 | 0,1792 | 0,0052 | 1,00 | 0,1792 | 0,0081 | 1,44 | 0,2048 | 0,0065 | 1,44 | 0,2048 | 0,0102 |
| A041 | KN Wien Prater | Stadionbrücke | 0,13 | 0,0235 | 0,0004 | 0,13 | 0,0235 | 0,0006 | 0,18 | 0,0329 | 0,0009 | 0,18 | 0,0329 | 0,0015 | 0,26 | 0,0376 | 0,0012 | 0,26 | 0,0376 | 0,0019 |
| A04- | Wien Simmeringer Haide | KN Wien Prater | 0,90 | 0,1622 | 0,0028 | 0,91 | 0,1622 | 0,0045 | 1,27 | 0,2271 | 0,0065 | 1,27 | 0,2271 | 0,0103 | 1,82 | 0,2595 | 0,0082 | 1,82 | 0,2595 | 0,0129 |
| A04- | KN Schwechat | Wien Simmeringer Haide | 0,81 | 0,1456 | 0,0025 | 0,81 | 0,1456 | 0,0040 | 1,14 | 0,2038 | 0,0059 | 1,14 | 0,2038 | 0,0092 | 1,63 | 0,2330 | 0,0074 | 1,64 | 0,2330 | 0,0116 |
| A04- | Flughafen Wien Schwechat | KN Schwechat | 1,17 | 0,2103 | 0,0037 | 1,17 | 0,2103 | 0,0058 | 1,64 | 0,2944 | 0,0085 | 1,65 | 0,2944 | 0,0133 | 2,36 | 0,3365 | 0,0107 | 2,37 | 0,3365 | 0,0168 |
| A04- | Fischamend | Flughafen Wien Schwechat | 1,31 | 0,2355 | 0,0041 | 1,31 | 0,2355 | 0,0065 | 1,84 | 0,3297 | 0,0095 | 1,85 | 0,3297 | 0,0149 | 2,64 | 0,3768 | 0,0120 | 2,65 | 0,3768 | 0,0188 |
| A04- | Bruck/Leitha West | Fischamend | 2,88 | 0,5164 | 0,0090 | 2,88 | 0,5164 | 0,0142 | 4,04 | 0,7230 | 0,0208 | 4,05 | 0,7230 | 0,0327 | 5,79 | 0,8263 | 0,0262 | 5,81 | 0,8263 | 0,0412 |
| A04- | Bruck/Leitha Ost | Bruck/Leitha West | 0,96 | 0,1715 | 0,0030 | 0,96 | 0,1715 | 0,0047 | 1,34 | 0,2401 | 0,0069 | 1,34 | 0,2401 | 0,0108 | 1,92 | 0,2744 | 0,0087 | 1,93 | 0,2744 | 0,0137 |
| A04- | KN Bruckneudorf | Bruck/Leitha Ost | 0,60 | 0,1070 | 0,0019 | 0,60 | 0,1070 | 0,0029 | 0,84 | 0,1498 | 0,0043 | 0,84 | 0,1498 | 0,0068 | 1,20 | 0,1712 | 0,0054 | 1,20 | 0,1712 | 0,0085 |
| A04- | Parndorf | KN Bruckneudorf | 0,38 | 0,0689 | 0,0012 | 0,38 | 0,0689 | 0,0019 | 0,54 | 0,0964 | 0,0028 | 0,54 | 0,0964 | 0,0044 | 0,77 | 0,1102 | 0,0035 | 0,77 | 0,1102 | 0,0055 |
| A04- | Neusiedl | Parndorf | 0,74 | 0,1332 | 0,0023 | 0,74 | 0,1332 | 0,0037 | 1,04 | 0,1865 | 0,0054 | 1,04 | 0,1865 | 0,0084 | 1,49 | 0,2131 | 0,0068 | 1,50 | 0,2131 | 0,0106 |
| A04- | Neusiedl/Gewerbepark | Neusiedl | 0,17 | 0,0309 | 0,0005 | 0,17 | 0,0309 | 0,0008 | 0,24 | 0,0432 | 0,0012 | 0,24 | 0,0432 | 0,0020 | 0,35 | 0,0494 | 0,0016 | 0,35 | 0,0494 | 0,0025 |
| A04- | Weiden/Gols | Neusiedl/Gewerbepark | 1,54 | 0,2762 | 0,0048 | 1,54 | 0,2762 | 0,0076 | 2,16 | 0,3867 | 0,0111 | 2,17 | 0,3867 | 0,0175 | 3,10 | 0,4420 | 0,0140 | 3,11 | 0,4420 | 0,0220 |
| A04- | Mönchhof | Weiden/Gols | 1,12 | 0,2015 | 0,0035 | 1,12 | 0,2015 | 0,0055 | 1,58 | 0,2821 | 0,0081 | 1,58 | 0,2821 | 0,0127 | 2,26 | 0,3224 | 0,0102 | 2,27 | 0,3224 | 0,0161 |
| A04- | Nickelsdorf | Mönchhof | 1,76 | 0,3157 | 0,0055 | 1,76 | 0,3157 | 0,0087 | 2,47 | 0,4420 | 0,0127 | 2,48 | 0,4420 | 0,0200 | 3,54 | 0,5052 | 0,0160 | 3,55 | 0,5052 | 0,0252 |
| A04- | Staatsgrenze Nickelsdorf | Nickelsdorf | 0,31 | 0,0559 | 0,0010 | 0,31 | 0,0559 | 0,0015 | 0,44 | 0,0783 | 0,0023 | 0,44 | 0,0783 | 0,0035 | 0,63 | 0,0895 | 0,0028 | 0,63 | 0,0895 | 0,0045 |
| A05- | Wolkersdorf Süd | KN Eibesbrunn | 0,61 | 0,1088 | 0,0019 | 0,61 | 0,1088 | 0,0030 | 0,85 | 0,1524 | 0,0044 | 0,85 | 0,1524 | 0,0069 | 1,22 | 0,1741 | 0,0055 | 1,22 | 0,1741 | 0,0087 |
| A05- | Ulrichskirchen | Wolkersdorf Süd | 0,66 | 0,1177 | 0,0021 | 0,66 | 0,1177 | 0,0032 | 0,92 | 0,1648 | 0,0047 | 0,92 | 0,1648 | 0,0074 | 1,32 | 0,1884 | 0,0060 | 1,32 | 0,1884 | 0,0094 |
| A05- | Wolkersdorf Nord | Ulrichskirchen | 0,43 | 0,0769 | 0,0013 | 0,43 | 0,0769 | 0,0021 | 0,60 | 0,1077 | 0,0031 | 0,60 | 0,1077 | 0,0049 | 0,86 | 0,1231 | 0,0039 | 0,87 | 0,1231 | 0,0061 |
| A05- | Hochleithen | Wolkersdorf Nord | 0,77 | 0,1380 | 0,0024 | 0,77 | 0,1380 | 0,0038 | 1,08 | 0,1932 | 0,0056 | 1,08 | 0,1932 | 0,0087 | 1,55 | 0,2208 | 0,0070 | 1,55 | 0,2208 | 0,0110 |
| A05- | Gaweinstal Mitte | Hochleithen | 1,54 | 0,2761 | 0,0048 | 1,54 | 0,2761 | 0,0076 | 2,16 | 0,3865 | 0,0111 | 2,16 | 0,3865 | 0,0175 | 3,10 | 0,4417 | 0,0140 | 3,10 | 0,4417 | 0,0220 |
| A05- | Gaweinstal Nord | Gaweinstal Mitte | 0,41 | 0,0730 | 0,0013 | 0,41 | 0,0730 | 0,0020 | 0,57 | 0,1023 | 0,0029 | 0,57 | 0,1023 | 0,0046 | 0,82 | 0,1169 | 0,0037 | 0,82 | 0,1169 | 0,0058 |
| A05- | Mistelbach Süd | Gaweinstal Nord | 0,70 | 0,1261 | 0,0022 | 0,70 | 0,1261 | 0,0035 | 0,99 | 0,1765 | 0,0051 | 0,99 | 0,1765 | 0,0080 | 1,41 | 0,2017 | 0,0064 | 1,42 | 0,2017 | 0,0101 |
| A05- | Mistelbach Ost / Wilfersdorf | Mistelbach Süd | 1,18 | 0,2116 | 0,0037 | 1,18 | 0,2116 | 0,0058 | 1,65 | 0,2962 | 0,0085 | 1,66 | 0,2962 | 0,0134 | 2,37 | 0,3386 | 0,0107 | 2,38 | 0,3386 | 0,0169 |
| A05- | Poysdorf Süd | Mistelbach Ost / Wilfersdorf | 1,19 | 0,2137 | 0,0037 | 1,19 | 0,2137 | 0,0059 | 1,67 | 0,2992 | 0,0086 | 1,68 | 0,2992 | 0,0135 | 2,40 | 0,3419 | 0,0108 | 2,40 | 0,3419 | 0,0170 |
| A05- | Großkrut | Poysdorf Süd | 1,57 | 0,2818 | 0,0049 | 1,57 | 0,2818 | 0,0077 | 2,20 | 0,3945 | 0,0113 | 2,21 | 0,3945 | 0,0178 | 3,16 | 0,4509 | 0,0143 | 3,17 | 0,4509 | 0,0225 |
| A05- | Poysdorf Nord | Großkrut | 1,53 | 0,2741 | 0,0048 | 1,53 | 0,2741 | 0,0075 | 2,14 | 0,3838 | 0,0110 | 2,15 | 0,3838 | 0,0173 | 3,07 | 0,4386 | 0,0139 | 3,08 | 0,4386 | 0,0219 |
| A06- | Potzneusiedl | KN Bruckneudorf | 1,94 | 0,3472 | 0,0061 | 1,94 | 0,3472 | 0,0095 | 2,71 | 0,4861 | 0,0140 | 2,72 | 0,4861 | 0,0220 | 3,89 | 0,5556 | 0,0176 | 3,90 | 0,5556 | 0,0277 |
| A06- | Gattendorf | Potzneusiedl | 0,84 | 0,1507 | 0,0026 | 0,84 | 0,1507 | 0,0041 | 1,18 | 0,2110 | 0,0061 | 1,18 | 0,2110 | 0,0095 | 1,69 | 0,2412 | 0,0076 | 1,69 | 0,2412 | 0,0120 |
| A06- | Kittsee | Gattendorf | 1,40 | 0,2521 | 0,0044 | 1,41 | 0,2521 | 0,0069 | 1,97 | 0,3529 | 0,0101 | 1,98 | 0,3529 | 0,0159 | 2,83 | 0,4033 | 0,0128 | 2,83 | 0,4033 | 0,0201 |
| A06- | Staatsgrenze Kittsee | Kittsee | 0,71 | 0,1280 | 0,0022 | 0,71 | 0,1280 | 0,0035 | 1,00 | 0,1793 | 0,0052 | 1,00 | 0,1793 | 0,0081 | 1,44 | 0,2049 | 0,0065 | 1,44 | 0,2049 | 0,0102 |
| A07- | Linz Franzosenhausweg | KN Linz | 0,50 | 0,0903 | 0,0016 | 0,50 | 0,0903 | 0,0025 | 0,71 | 0,1264 | 0,0036 | 0,71 | 0,1264 | 0,0057 | 1,01 | 0,1445 | 0,0046 | 1,02 | 0,1445 | 0,0072 |
| A07- | Linz Salzburger Straße Neue Welt | Linz Franzosenhausweg | 0,44 | 0,0788 | 0,0014 | 0,44 | 0,0788 | 0,0022 | 0,62 | 0,1104 | 0,0032 | 0,62 | 0,1104 | 0,0050 | 0,88 | 0,1261 | 0,0040 | 0,89 | 0,1261 | 0,0063 |
| A07- | Muldenstraße Bindermichl | Linz Salzburger Straße Neue Welt | 0,30 | 0,0547 | 0,0010 | 0,31 | 0,0547 | 0,0015 | 0,43 | 0,0766 | 0,0022 | 0,43 | 0,0766 | 0,0035 | 0,61 | 0,0876 | 0,0028 | 0,62 | 0,0876 | 0,0044 |
| A07- | Leonding Linz Zentrum | Muldenstraße Bindermichl | 0,15 | 0,0266 | 0,0005 | 0,15 | 0,0266 | 0,0007 | 0,21 | 0,0372 | 0,0011 | 0,21 | 0,0372 | 0,0017 | 0,30 | 0,0425 | 0,0013 | 0,30 | 0,0425 | 0,0021 |
| A07- | Linz Wiener Straße | Leonding Linz Zentrum | 0,21 | 0,0374 | 0,0007 | 0,21 | 0,0374 | 0,0010 | 0,29 | 0,0523 | 0,0015 | 0,29 | 0,0523 | 0,0024 | 0,42 | 0,0598 | 0,0019 | 0,42 | 0,0598 | 0,0030 |
| A07- | Linz VOEST | Linz Wiener Straße | 0,19 | 0,0347 | 0,0006 | 0,19 | 0,0347 | 0,0010 | 0,27 | 0,0486 | 0,0014 | 0,27 | 0,0486 | 0,0022 | 0,39 | 0,0556 | 0,0018 | 0,39 | 0,0556 | 0,0028 |
| A07- | Linz Industriezeile | Linz VOEST | 0,15 | 0,0272 | 0,0005 | 0,15 | 0,0272 | 0,0007 | 0,21 | 0,0381 | 0,0011 | 0,21 | 0,0381 | 0,0017 | 0,31 | 0,0436 | 0,0014 | 0,31 | 0,0436 | 0,0022 |
| A07- | Linz Prinz Eugenstraße | Linz Industriezeile | 0,24 | 0,0432 | 0,0008 | 0,24 | 0,0432 | 0,0012 | 0,34 | 0,0605 | 0,0017 | 0,34 | 0,0605 | 0,0027 | 0,49 | 0,0692 | 0,0022 | 0,49 | 0,0692 | 0,0034 |
| A07- | Linz Hafensstraße | Linz Prinz Eugenstraße | 0,45 | 0,0809 | 0,0014 | 0,45 | 0,0809 | 0,0022 | 0,63 | 0,1133 | 0,0033 | 0,63 | 0,1133 | 0,0051 | 0,91 | 0,1295 | 0,0041 | 0,91 | 0,1295 | 0,0065 |
| A07- | Linz Urfahr | Linz Hafensstraße | 0,18 | 0,0318 | 0,0006 | 0,18 | 0,0318 | 0,0009 | 0,25 | 0,0445 | 0,0013 | 0,25 | 0,0445 | 0,0020 | 0,36 | 0,0509 | 0,0016 | 0,36 | 0,0509 | 0,0025 |
| A07- | Linz Dornach | Linz Urfahr | 0,43 | 0,0770 | 0,0013 | 0,43 | 0,0770</ | | | | | | | | | | | | | |

| | | | | | | | | | | | | | | | | | | | | |
|------|---|--------------------------------------|-------|--------|--------|-------|--------|--------|-------|--------|--------|-------|--------|--------|-------|--------|--------|-------|--------|--------|
| A08- | Staatsgrenze Suben | Schärding Suben | 0,50 | 0,0893 | 0,0016 | 0,50 | 0,0893 | 0,0025 | 0,70 | 0,1250 | 0,0036 | 0,70 | 0,1250 | 0,0056 | 1,00 | 0,1428 | 0,0045 | 1,00 | 0,1428 | 0,0071 |
| A09- | Ried im Traunkreis | KN Voralpenkreuz | 1,23 | 0,2200 | 0,0039 | 1,23 | 0,2200 | 0,0061 | 1,72 | 0,3081 | 0,0089 | 1,73 | 0,3081 | 0,0139 | 2,47 | 0,3521 | 0,0112 | 2,47 | 0,3521 | 0,0175 |
| A09- | Inzersdorf Kirchdorf | Ried im Traunkreis | 2,30 | 0,4128 | 0,0072 | 2,30 | 0,4128 | 0,0114 | 3,23 | 0,5779 | 0,0166 | 3,24 | 0,5779 | 0,0261 | 4,63 | 0,6604 | 0,0209 | 4,64 | 0,6604 | 0,0329 |
| A09- | Klaus | Inzersdorf Kirchdorf | 2,80 | 0,5028 | 0,0088 | 2,81 | 0,5028 | 0,0138 | 3,93 | 0,7039 | 0,0202 | 3,94 | 0,7039 | 0,0318 | 5,64 | 0,8045 | 0,0255 | 5,65 | 0,8045 | 0,0401 |
| A09- | St. Pankratz | Klaus | 1,78 | 0,3196 | 0,0056 | 1,78 | 0,3196 | 0,0088 | 2,50 | 0,4474 | 0,0129 | 2,51 | 0,4474 | 0,0202 | 3,58 | 0,5114 | 0,0162 | 3,59 | 0,5114 | 0,0255 |
| A09- | Roßleiten Windischgarsten | St. Pankratz | 2,48 | 0,4459 | 0,0078 | 2,49 | 0,4459 | 0,0123 | 3,49 | 0,6243 | 0,0179 | 3,50 | 0,6243 | 0,0282 | 5,00 | 0,7135 | 0,0226 | 5,01 | 0,7135 | 0,0356 |
| A09- | Gleinkerau | Roßleiten Windischgarsten | 1,17 | 0,2096 | 0,0037 | 1,17 | 0,2096 | 0,0058 | 1,64 | 0,2934 | 0,0084 | 1,64 | 0,2934 | 0,0133 | 2,35 | 0,3354 | 0,0106 | 2,36 | 0,3354 | 0,0167 |
| A09- | Spital am Pyhrn | Gleinkerau | 0,88 | 0,1580 | 0,0028 | 0,88 | 0,1580 | 0,0043 | 1,24 | 0,2212 | 0,0064 | 1,24 | 0,2212 | 0,0100 | 1,77 | 0,2528 | 0,0080 | 1,78 | 0,2528 | 0,0126 |
| A09- | Ardning / Admont | Spital am Pyhrn | 4,53 | 0,4022 | 0,0070 | 4,54 | 0,4022 | 0,0111 | 6,35 | 0,5631 | 0,0162 | 6,36 | 0,5631 | 0,0254 | 9,33 | 0,6436 | 0,0204 | 9,34 | 0,6436 | 0,0321 |
| A09- | Liezen | Ardning / Admont | 0,51 | 0,0917 | 0,0016 | 0,51 | 0,0917 | 0,0025 | 0,72 | 0,1284 | 0,0037 | 0,72 | 0,1284 | 0,0058 | 1,03 | 0,1467 | 0,0047 | 1,03 | 0,1467 | 0,0073 |
| A09- | Rottenmann | Liezen | 1,07 | 0,1916 | 0,0034 | 1,07 | 0,1916 | 0,0053 | 1,50 | 0,2682 | 0,0077 | 1,50 | 0,2682 | 0,0121 | 2,15 | 0,3065 | 0,0097 | 2,15 | 0,3065 | 0,0153 |
| A09- | Trieben | Rottenmann | 2,66 | 0,4776 | 0,0084 | 2,67 | 0,4776 | 0,0131 | 3,73 | 0,6686 | 0,0192 | 3,74 | 0,6686 | 0,0302 | 5,36 | 0,7641 | 0,0242 | 5,37 | 0,7641 | 0,0381 |
| A09- | Treglwang | Trieben | 2,16 | 0,3883 | 0,0068 | 2,17 | 0,3883 | 0,0107 | 3,04 | 0,5436 | 0,0156 | 3,04 | 0,5436 | 0,0246 | 4,36 | 0,6212 | 0,0197 | 4,37 | 0,6212 | 0,0310 |
| A09- | Kalwang | Treglwang | 2,91 | 0,5218 | 0,0091 | 2,91 | 0,5218 | 0,0143 | 4,08 | 0,7305 | 0,0210 | 4,09 | 0,7305 | 0,0330 | 5,85 | 0,8349 | 0,0265 | 5,87 | 0,8349 | 0,0416 |
| A09- | Mautern | Kalwang | 1,35 | 0,2430 | 0,0043 | 1,36 | 0,2430 | 0,0067 | 1,90 | 0,3401 | 0,0098 | 1,90 | 0,3401 | 0,0154 | 2,73 | 0,3887 | 0,0123 | 2,73 | 0,3887 | 0,0194 |
| A09- | Kammern | Mautern | 1,52 | 0,2733 | 0,0048 | 1,53 | 0,2733 | 0,0075 | 2,14 | 0,3826 | 0,0110 | 2,14 | 0,3826 | 0,0173 | 3,07 | 0,4373 | 0,0139 | 3,07 | 0,4373 | 0,0218 |
| A09- | Traboch | Kammern | 1,59 | 0,2858 | 0,0050 | 1,60 | 0,2858 | 0,0079 | 2,23 | 0,4001 | 0,0115 | 2,24 | 0,4001 | 0,0181 | 3,21 | 0,4572 | 0,0145 | 3,21 | 0,4572 | 0,0228 |
| A09- | Terminal St. Michael | Traboch | 0,31 | 0,0561 | 0,0010 | 0,31 | 0,0561 | 0,0015 | 0,44 | 0,0786 | 0,0023 | 0,44 | 0,0786 | 0,0035 | 0,63 | 0,0898 | 0,0028 | 0,63 | 0,0898 | 0,0045 |
| A09- | KN St. Michael | Terminal St. Michael | 0,59 | 0,1052 | 0,0018 | 0,59 | 0,1052 | 0,0029 | 0,82 | 0,1473 | 0,0042 | 0,82 | 0,1473 | 0,0067 | 1,18 | 0,1683 | 0,0053 | 1,18 | 0,1683 | 0,0084 |
| A09- | Übelbach | KN St. Michael | 11,04 | 0,9797 | 0,0171 | 11,05 | 0,9797 | 0,0269 | 15,48 | 1,3716 | 0,0394 | 15,50 | 1,3716 | 0,0620 | 22,72 | 1,5676 | 0,0497 | 22,74 | 1,5676 | 0,0781 |
| A09- | KN Peggau Deutschefstritz | Übelbach | 1,81 | 0,3240 | 0,0057 | 1,81 | 0,3240 | 0,0089 | 2,53 | 0,4537 | 0,0130 | 2,54 | 0,4537 | 0,0205 | 3,63 | 0,5185 | 0,0164 | 3,64 | 0,5185 | 0,0258 |
| A09- | Gratkorn Nord | KN Peggau Deutschefstritz | 0,86 | 0,1535 | 0,0027 | 0,86 | 0,1535 | 0,0042 | 1,20 | 0,2149 | 0,0062 | 1,20 | 0,2149 | 0,0097 | 1,72 | 0,2456 | 0,0078 | 1,73 | 0,2456 | 0,0122 |
| A09- | Gratkorn Süd | Gratkorn Nord | 0,94 | 0,1686 | 0,0030 | 0,94 | 0,1686 | 0,0046 | 1,32 | 0,2360 | 0,0068 | 1,32 | 0,2360 | 0,0107 | 1,89 | 0,2698 | 0,0086 | 1,90 | 0,2698 | 0,0134 |
| A09- | Graz Nord | Gratkorn Süd | 0,21 | 0,0374 | 0,0007 | 0,21 | 0,0374 | 0,0010 | 0,29 | 0,0523 | 0,0015 | 0,29 | 0,0523 | 0,0024 | 0,42 | 0,0598 | 0,0019 | 0,42 | 0,0598 | 0,0030 |
| A09- | Graz Webling | Graz Nord | 2,38 | 0,4274 | 0,0075 | 2,39 | 0,4274 | 0,0118 | 3,34 | 0,5983 | 0,0172 | 3,35 | 0,5983 | 0,0270 | 4,79 | 0,6838 | 0,0217 | 4,81 | 0,6838 | 0,0341 |
| A09- | Seiersberg | Graz Webling | 0,63 | 0,1136 | 0,0020 | 0,63 | 0,1136 | 0,0031 | 0,89 | 0,1590 | 0,0046 | 0,89 | 0,1590 | 0,0072 | 1,27 | 0,1818 | 0,0058 | 1,28 | 0,1818 | 0,0091 |
| A09- | KN Graz West | Seiersberg | 0,31 | 0,0556 | 0,0010 | 0,31 | 0,0556 | 0,0015 | 0,43 | 0,0778 | 0,0022 | 0,44 | 0,0778 | 0,0035 | 0,62 | 0,0890 | 0,0028 | 0,63 | 0,0890 | 0,0044 |
| A09- | Schwarzlsee | KN Graz West | 0,31 | 0,0548 | 0,0010 | 0,31 | 0,0548 | 0,0015 | 0,43 | 0,0767 | 0,0022 | 0,43 | 0,0767 | 0,0035 | 0,61 | 0,0877 | 0,0028 | 0,62 | 0,0877 | 0,0044 |
| A09- | Schachenwald / IBC Businesscenter | Schwarzlsee | 0,34 | 0,0613 | 0,0011 | 0,34 | 0,0613 | 0,0017 | 0,48 | 0,0858 | 0,0025 | 0,48 | 0,0858 | 0,0039 | 0,69 | 0,0980 | 0,0031 | 0,69 | 0,0980 | 0,0049 |
| A09- | Kalsdorf | Schachenwald / IBC Businesscenter | 0,35 | 0,0623 | 0,0011 | 0,35 | 0,0623 | 0,0017 | 0,49 | 0,0872 | 0,0025 | 0,49 | 0,0872 | 0,0039 | 0,70 | 0,0997 | 0,0032 | 0,70 | 0,0997 | 0,0050 |
| A09- | Werndorf Terminal | Kalsdorf | 0,87 | 0,1560 | 0,0027 | 0,87 | 0,1560 | 0,0043 | 1,22 | 0,2184 | 0,0063 | 1,22 | 0,2184 | 0,0099 | 1,75 | 0,2496 | 0,0079 | 1,75 | 0,2496 | 0,0124 |
| A09- | Wildon | Werndorf Terminal | 0,97 | 0,1744 | 0,0031 | 0,97 | 0,1744 | 0,0048 | 1,36 | 0,2441 | 0,0070 | 1,37 | 0,2441 | 0,0110 | 1,96 | 0,2790 | 0,0088 | 1,96 | 0,2790 | 0,0139 |
| A09- | Hengsberg | Wildon | 0,47 | 0,0851 | 0,0015 | 0,48 | 0,0851 | 0,0023 | 0,67 | 0,1192 | 0,0034 | 0,67 | 0,1192 | 0,0054 | 0,95 | 0,1362 | 0,0043 | 0,96 | 0,1362 | 0,0068 |
| A09- | Lebring | Hengsberg | 0,84 | 0,1508 | 0,0026 | 0,84 | 0,1508 | 0,0041 | 1,18 | 0,2111 | 0,0061 | 1,18 | 0,2111 | 0,0095 | 1,69 | 0,2413 | 0,0077 | 1,70 | 0,2413 | 0,0120 |
| A09- | Leibnitz | Lebring | 1,45 | 0,2610 | 0,0046 | 1,46 | 0,2610 | 0,0072 | 2,04 | 0,3655 | 0,0105 | 2,05 | 0,3655 | 0,0165 | 2,93 | 0,4177 | 0,0132 | 2,94 | 0,4177 | 0,0208 |
| A09- | Vogau Straß | Leibnitz | 1,78 | 0,3192 | 0,0056 | 1,78 | 0,3192 | 0,0088 | 2,50 | 0,4469 | 0,0128 | 2,50 | 0,4469 | 0,0202 | 3,58 | 0,5108 | 0,0162 | 3,59 | 0,5108 | 0,0255 |
| A09- | Gersdorf | Vogau Straß | 0,86 | 0,1548 | 0,0027 | 0,86 | 0,1548 | 0,0043 | 1,21 | 0,2168 | 0,0062 | 1,21 | 0,2168 | 0,0098 | 1,74 | 0,2477 | 0,0079 | 1,74 | 0,2477 | 0,0123 |
| A09- | Spielfeld | Gersdorf | 0,45 | 0,0816 | 0,0014 | 0,46 | 0,0816 | 0,0022 | 0,64 | 0,1142 | 0,0033 | 0,64 | 0,1142 | 0,0052 | 0,92 | 0,1306 | 0,0041 | 0,92 | 0,1306 | 0,0065 |
| A09- | Staatsgrenze Spielfeld | Spielfeld | 0,41 | 0,0744 | 0,0013 | 0,42 | 0,0744 | 0,0020 | 0,58 | 0,1042 | 0,0030 | 0,58 | 0,1042 | 0,0047 | 0,83 | 0,1190 | 0,0038 | 0,84 | 0,1190 | 0,0059 |
| A10- | Salzburg Süd / Anif | KN Salzburg | 1,68 | 0,3010 | 0,0053 | 1,68 | 0,3010 | 0,0083 | 2,35 | 0,4213 | 0,0121 | 2,36 | 0,4213 | 0,0190 | 3,38 | 0,4815 | 0,0153 | 3,38 | 0,4815 | 0,0240 |
| A10- | Puch Urstein | Salzburg Süd / Anif | 0,57 | 0,1021 | 0,0018 | 0,57 | 0,1021 | 0,0028 | 0,80 | 0,1430 | 0,0041 | 0,80 | 0,1430 | 0,0065 | 1,15 | 0,1634 | 0,0052 | 1,15 | 0,1634 | 0,0081 |
| A10- | Hallein | Puch Urstein | 1,17 | 0,2108 | 0,0037 | 1,18 | 0,2108 | 0,0058 | 1,65 | 0,2952 | 0,0085 | 1,65 | 0,2952 | 0,0133 | 2,36 | 0,3373 | 0,0107 | 2,37 | 0,3373 | 0,0168 |
| A10- | Kuchl | Hallein | 1,30 | 0,2342 | 0,0041 | 1,31 | 0,2342 | 0,0064 | 1,83 | 0,3278 | 0,0094 | 1,84 | 0,3278 | 0,0148 | 2,63 | 0,3747 | 0,0119 | 2,63 | 0,3747 | 0,0187 |
| A10- | Golling / Abtenau | Kuchl | 1,31 | 0,2354 | 0,0041 | 1,31 | 0,2354 | 0,0065 | 1,84 | 0,3296 | 0,0095 | 1,85 | 0,3296 | 0,0149 | 2,64 | 0,3766 | 0,0119 | 2,65 | 0,3766 | 0,0188 |
| A10- | Paß Lueg | Golling / Abtenau | 1,37 | 0,2456 | 0,0043 | 1,37 | 0,2456 | 0,0068 | 1,92 | 0,3439 | 0,0099 | 1,93 | 0,3439 | 0,0155 | 2,76 | 0,3930 | 0,0125 | 2,76 | 0,3930 | 0,0196 |
| A10- | Werfen | Paß Lueg | 1,95 | 0,3499 | 0,0061 | 1,95 | 0,3499 | 0,0096 | 2,74 | 0,4898 | 0,0141 | 2,74 | 0,4898 | 0,0221 | 3,92 | 0,5598 | 0,0178 | 3,93 | 0,5598 | 0,0279 |
| A10- | Pfarrwerfen / Werfen | Werfen | 0,25 | 0,0456 | 0,0008 | 0,25 | 0,0456 | 0,0013 | 0,36 | 0,0638 | 0,0018 | 0,36 | 0,0638 | 0,0029 | 0,51 | 0,0730 | 0,0023 | 0,51 | 0,0730 | 0,0036 |
| A10- | KN Pongau | Pfarrwerfen / Werfen | 0,55 | 0,0990 | 0,0017 | 0,55 | 0,0990 | 0,0027 | 0,77 | 0,1385 | 0,0040 | 0,78 | 0,1385 | 0,0063 | 1,11 | 0,1583 | 0,0050 | 1,11 | 0,1583 | 0,0079 |
| A101 | Bischofshofen Mühlbach a. Hochkönig | KN Pongau | 0,82 | 0,1472 | 0,0026 | 0,82 | 0,1472 | 0,0040 | 1,15 | 0,2061 | 0,0059 | 1,15 | 0,2061 | 0,0093 | 1,65 | 0,2355 | 0,0075 | 1,66 | 0,2355 | 0,0117 |
| A10- | Lammertal Hüttal | KN Pongau | 2,24 | 0,4025 | 0,0070 | 2,25 | 0,4025 | 0,0111 | 3,15 | 0,5635 | 0,0162 | 3,16 | 0,5635 | 0,0255 | 4,51 | 0,6440 | 0,0204 | 4,53 | 0,6440 | 0,0321 |
| A10- | F. Verbindung GH Eben | Lammertal Hüttal | 0,58 | 0,1036 | 0,0018 | 0,58 | 0,1036 | 0,0028 | 0,81 | 0,1450 | 0,0042 | 0,81 | 0,1450 | 0,0066 | 1,16 | 0,1658 | 0,0053 | 1,17 | 0,1658 | 0,0083 |

| | | | | | | | | | | | | | | | | | | | | |
|------|-------------------------------------|-------------------------------------|------|--------|--------|------|--------|--------|------|--------|--------|------|--------|--------|-------|--------|--------|-------|--------|--------|
| A12- | Kufstein Nord | Staatsgrenze Kufstein | 0,36 | 0,0000 | 0,0000 | 0,36 | 0,0000 | 0,0000 | 0,51 | 0,0000 | 0,0000 | 0,51 | 0,0000 | 0,0000 | 0,76 | 0,0000 | 0,0000 | 0,76 | 0,0000 | 0,0000 |
| A12- | Kufstein Süd | Kufstein Nord | 0,93 | 0,0000 | 0,0000 | 0,93 | 0,0000 | 0,0000 | 1,31 | 0,0000 | 0,0000 | 1,31 | 0,0000 | 0,0000 | 1,96 | 0,0000 | 0,0000 | 1,96 | 0,0000 | 0,0000 |
| A12- | Kirchbichl Langkampfen | Kufstein Süd | 1,27 | 0,0000 | 0,0000 | 1,27 | 0,0000 | 0,0000 | 1,78 | 0,0000 | 0,0000 | 1,78 | 0,0000 | 0,0000 | 2,68 | 0,0000 | 0,0000 | 2,68 | 0,0000 | 0,0000 |
| A12- | Wörgl Ost St.Johann i. T. Brixental | Kirchbichl Langkampfen | 1,25 | 0,0000 | 0,0000 | 1,25 | 0,0000 | 0,0000 | 1,75 | 0,0000 | 0,0000 | 1,75 | 0,0000 | 0,0000 | 2,62 | 0,0000 | 0,0000 | 2,62 | 0,0000 | 0,0000 |
| A12- | Wörgl West | Wörgl Ost St.Johann i. T. Brixental | 0,66 | 0,0000 | 0,0000 | 0,66 | 0,0000 | 0,0000 | 0,92 | 0,0000 | 0,0000 | 0,92 | 0,0000 | 0,0000 | 1,38 | 0,0000 | 0,0000 | 1,38 | 0,0000 | 0,0000 |
| A12- | Kramsach Rattenberg Brixlegg | Wörgl West | 2,80 | 0,0000 | 0,0000 | 2,80 | 0,0000 | 0,0000 | 3,92 | 0,0000 | 0,0000 | 3,92 | 0,0000 | 0,0000 | 5,88 | 0,0000 | 0,0000 | 5,88 | 0,0000 | 0,0000 |
| A12- | Wiesing Achensee Zillertal | Kramsach Rattenberg Brixlegg | 1,72 | 0,0000 | 0,0000 | 1,72 | 0,0000 | 0,0000 | 2,40 | 0,0000 | 0,0000 | 2,40 | 0,0000 | 0,0000 | 3,61 | 0,0000 | 0,0000 | 3,61 | 0,0000 | 0,0000 |
| A12- | Jenbach | Wiesing Achensee Zillertal | 0,68 | 0,0000 | 0,0000 | 0,68 | 0,0000 | 0,0000 | 0,95 | 0,0000 | 0,0000 | 0,95 | 0,0000 | 0,0000 | 1,43 | 0,0000 | 0,0000 | 1,43 | 0,0000 | 0,0000 |
| A12- | Schwaz | Jenbach | 1,50 | 0,0000 | 0,0000 | 1,50 | 0,0000 | 0,0000 | 2,10 | 0,0000 | 0,0000 | 2,10 | 0,0000 | 0,0000 | 3,15 | 0,0000 | 0,0000 | 3,15 | 0,0000 | 0,0000 |
| A12- | Vomp | Schwaz | 0,86 | 0,0000 | 0,0000 | 0,86 | 0,0000 | 0,0000 | 1,20 | 0,0000 | 0,0000 | 1,20 | 0,0000 | 0,0000 | 1,80 | 0,0000 | 0,0000 | 1,80 | 0,0000 | 0,0000 |
| A12- | Wattens | Vomp | 1,77 | 0,0000 | 0,0000 | 1,77 | 0,0000 | 0,0000 | 2,47 | 0,0000 | 0,0000 | 2,47 | 0,0000 | 0,0000 | 3,71 | 0,0000 | 0,0000 | 3,71 | 0,0000 | 0,0000 |
| A12- | Hall/Tirol Mitte | Wattens | 1,57 | 0,0000 | 0,0000 | 1,57 | 0,0000 | 0,0000 | 2,19 | 0,0000 | 0,0000 | 2,19 | 0,0000 | 0,0000 | 3,29 | 0,0000 | 0,0000 | 3,29 | 0,0000 | 0,0000 |
| A12- | Hall/Tirol West | Hall/Tirol Mitte | 0,63 | 0,0000 | 0,0000 | 0,63 | 0,0000 | 0,0000 | 0,88 | 0,0000 | 0,0000 | 0,88 | 0,0000 | 0,0000 | 1,32 | 0,0000 | 0,0000 | 1,32 | 0,0000 | 0,0000 |
| A12- | A12 Innsbruck Ost | Hall/Tirol West | 0,70 | 0,0000 | 0,0000 | 0,70 | 0,0000 | 0,0000 | 0,97 | 0,0000 | 0,0000 | 0,97 | 0,0000 | 0,0000 | 1,46 | 0,0000 | 0,0000 | 1,46 | 0,0000 | 0,0000 |
| A12- | Innsbruck Mitte | A12 Innsbruck Ost | 0,48 | 0,0226 | 0,0004 | 0,48 | 0,0226 | 0,0006 | 0,67 | 0,0317 | 0,0009 | 0,67 | 0,0317 | 0,0014 | 0,99 | 0,0362 | 0,0011 | 0,99 | 0,0362 | 0,0018 |
| A12- | A12 Innsbruck West | Innsbruck Mitte | 0,71 | 0,1280 | 0,0022 | 0,71 | 0,1280 | 0,0035 | 1,00 | 0,1792 | 0,0052 | 1,00 | 0,1792 | 0,0081 | 1,44 | 0,2048 | 0,0065 | 1,44 | 0,2048 | 0,0102 |
| A12- | Innsbruck Kranebitten | A12 Innsbruck West | 0,93 | 0,1678 | 0,0029 | 0,94 | 0,1678 | 0,0046 | 1,31 | 0,2349 | 0,0068 | 1,32 | 0,2349 | 0,0106 | 1,88 | 0,2684 | 0,0085 | 1,89 | 0,2684 | 0,0134 |
| A12- | Zirl Ost Garmisch Seefeld | Innsbruck Kranebitten | 1,08 | 0,1947 | 0,0034 | 1,09 | 0,1947 | 0,0054 | 1,52 | 0,2726 | 0,0078 | 1,53 | 0,2726 | 0,0123 | 2,18 | 0,3115 | 0,0099 | 2,19 | 0,3115 | 0,0155 |
| A12- | Zirl West | Zirl Ost Garmisch Seefeld | 0,68 | 0,1218 | 0,0021 | 0,68 | 0,1218 | 0,0033 | 0,95 | 0,1705 | 0,0049 | 0,95 | 0,1705 | 0,0077 | 1,37 | 0,1949 | 0,0062 | 1,37 | 0,1949 | 0,0097 |
| A12- | Petttau | Zirl West | 1,22 | 0,2181 | 0,0038 | 1,22 | 0,2181 | 0,0060 | 1,71 | 0,3054 | 0,0088 | 1,71 | 0,3054 | 0,0138 | 2,45 | 0,3490 | 0,0111 | 2,45 | 0,3490 | 0,0174 |
| A12- | Telfs Ost | Petttau | 1,23 | 0,2205 | 0,0039 | 1,23 | 0,2205 | 0,0061 | 1,72 | 0,3087 | 0,0089 | 1,73 | 0,3087 | 0,0139 | 2,47 | 0,3528 | 0,0112 | 2,48 | 0,3528 | 0,0176 |
| A12- | Telfs West | Telfs Ost | 0,60 | 0,1077 | 0,0019 | 0,60 | 0,1077 | 0,0030 | 0,84 | 0,1508 | 0,0043 | 0,84 | 0,1508 | 0,0068 | 1,21 | 0,1723 | 0,0055 | 1,21 | 0,1723 | 0,0086 |
| A12- | Mötz Reutte | Telfs West | 1,94 | 0,3480 | 0,0061 | 1,94 | 0,3480 | 0,0096 | 2,72 | 0,4872 | 0,0140 | 2,73 | 0,4872 | 0,0220 | 3,90 | 0,5568 | 0,0177 | 3,91 | 0,5568 | 0,0278 |
| A12- | Haiming Ötztal | Mötz Reutte | 2,26 | 0,4048 | 0,0071 | 2,26 | 0,4048 | 0,0111 | 3,16 | 0,5667 | 0,0163 | 3,17 | 0,5667 | 0,0256 | 4,54 | 0,6477 | 0,0205 | 4,55 | 0,6477 | 0,0323 |
| A12- | Imst | Haiming Ötztal | 1,80 | 0,3222 | 0,0056 | 1,80 | 0,3222 | 0,0089 | 2,52 | 0,4511 | 0,0130 | 2,53 | 0,4511 | 0,0204 | 3,61 | 0,5156 | 0,0164 | 3,62 | 0,5156 | 0,0257 |
| A12- | Imst Au | Imst | 0,53 | 0,0950 | 0,0017 | 0,53 | 0,0950 | 0,0026 | 0,74 | 0,1331 | 0,0038 | 0,75 | 0,1331 | 0,0060 | 1,07 | 0,1521 | 0,0048 | 1,07 | 0,1521 | 0,0076 |
| A12- | Mils | Imst Au | 0,43 | 0,0767 | 0,0013 | 0,43 | 0,0767 | 0,0021 | 0,60 | 0,1074 | 0,0031 | 0,60 | 0,1074 | 0,0049 | 0,86 | 0,1228 | 0,0039 | 0,86 | 0,1228 | 0,0061 |
| A12- | Mils Schönwies | Mils | 1,05 | 0,1888 | 0,0033 | 1,05 | 0,1888 | 0,0052 | 1,48 | 0,2643 | 0,0076 | 1,48 | 0,2643 | 0,0119 | 2,12 | 0,3021 | 0,0096 | 2,12 | 0,3021 | 0,0151 |
| A12- | KN Oberinntal | Mils Schönwies | 0,93 | 0,1672 | 0,0029 | 0,93 | 0,1672 | 0,0046 | 1,31 | 0,2341 | 0,0067 | 1,31 | 0,2341 | 0,0106 | 1,88 | 0,2675 | 0,0085 | 1,88 | 0,2675 | 0,0133 |
| A12- | Zams | KN Oberinntal | 0,25 | 0,0440 | 0,0008 | 0,25 | 0,0440 | 0,0012 | 0,34 | 0,0616 | 0,0018 | 0,35 | 0,0616 | 0,0028 | 0,49 | 0,0704 | 0,0022 | 0,49 | 0,0704 | 0,0035 |
| A122 | Fließ | KN Oberinntal | 1,74 | 0,3128 | 0,0055 | 1,75 | 0,3128 | 0,0086 | 2,45 | 0,4379 | 0,0126 | 2,45 | 0,4379 | 0,0198 | 3,51 | 0,5005 | 0,0159 | 3,52 | 0,5005 | 0,0249 |
| A13- | A13 Innsbruck Süd | A12 Innsbruck Ost | 2,20 | 0,0000 | 0,0000 | 2,20 | 0,0000 | 0,0000 | 3,08 | 0,0000 | 0,0000 | 3,08 | 0,0000 | 0,0000 | 4,62 | 0,0000 | 0,0000 | 8,50 | 0,0000 | 0,0000 |
| A13- | Zenzenhof | A13 Innsbruck Süd | 0,88 | 0,0000 | 0,0000 | 0,88 | 0,0000 | 0,0000 | 1,23 | 0,0000 | 0,0000 | 1,23 | 0,0000 | 0,0000 | 1,84 | 0,0000 | 0,0000 | 3,68 | 0,0000 | 0,0000 |
| A13- | Igls Patsch | Zenzenhof | 1,62 | 0,0000 | 0,0000 | 1,62 | 0,0000 | 0,0000 | 2,27 | 0,0000 | 0,0000 | 2,27 | 0,0000 | 0,0000 | 3,41 | 0,0000 | 0,0000 | 6,82 | 0,0000 | 0,0000 |
| A13- | Schönberg Stubaital | Igls Patsch | 1,76 | 0,0000 | 0,0000 | 1,76 | 0,0000 | 0,0000 | 2,46 | 0,0000 | 0,0000 | 2,46 | 0,0000 | 0,0000 | 3,69 | 0,0000 | 0,0000 | 7,38 | 0,0000 | 0,0000 |
| A13- | Matrei Steinach | Schönberg Stubaital | 5,54 | 0,0000 | 0,0000 | 5,54 | 0,0000 | 0,0000 | 7,76 | 0,0000 | 0,0000 | 7,76 | 0,0000 | 0,0000 | 11,63 | 0,0000 | 0,0000 | 23,26 | 0,0000 | 0,0000 |
| A13- | Nösslach | Matrei Steinach | 4,46 | 0,0000 | 0,0000 | 4,46 | 0,0000 | 0,0000 | 6,24 | 0,0000 | 0,0000 | 6,24 | 0,0000 | 0,0000 | 9,36 | 0,0000 | 0,0000 | 18,72 | 0,0000 | 0,0000 |
| A13- | Brenner-Nord | Nösslach | 4,00 | 0,0000 | 0,0000 | 4,00 | 0,0000 | 0,0000 | 5,60 | 0,0000 | 0,0000 | 5,60 | 0,0000 | 0,0000 | 8,40 | 0,0000 | 0,0000 | 16,80 | 0,0000 | 0,0000 |
| A13- | Staatsgrenze Brennerpass | Brenner-Nord | 0,79 | 0,0000 | 0,0000 | 0,79 | 0,0000 | 0,0000 | 1,11 | 0,0000 | 0,0000 | 1,11 | 0,0000 | 0,0000 | 1,66 | 0,0000 | 0,0000 | 3,32 | 0,0000 | 0,0000 |
| A131 | A13 Innsbruck Süd | A12 Innsbruck West | 1,43 | 0,0416 | 0,0007 | 1,43 | 0,0416 | 0,0011 | 2,01 | 0,0583 | 0,0017 | 2,01 | 0,0583 | 0,0026 | 2,99 | 0,0666 | 0,0021 | 5,51 | 0,0666 | 0,0033 |
| A14- | Hörbranz Lochau | Staatsgrenze Hörbranz | 0,28 | 0,0504 | 0,0009 | 0,28 | 0,0504 | 0,0014 | 0,39 | 0,0706 | 0,0020 | 0,40 | 0,0706 | 0,0032 | 0,57 | 0,0807 | 0,0026 | 0,57 | 0,0807 | 0,0040 |
| A14- | KN Bregenz | Hörbranz Lochau | 1,73 | 0,3100 | 0,0054 | 1,73 | 0,3100 | 0,0085 | 2,42 | 0,4339 | 0,0125 | 2,43 | 0,4339 | 0,0196 | 3,48 | 0,4959 | 0,0157 | 3,49 | 0,4959 | 0,0247 |
| A14- | Lauterach Wolfurt | KN Bregenz | 0,09 | 0,0156 | 0,0003 | 0,09 | 0,0156 | 0,0004 | 0,12 | 0,0218 | 0,0006 | 0,12 | 0,0218 | 0,0010 | 0,17 | 0,0249 | 0,0008 | 0,17 | 0,0249 | 0,0012 |
| A14- | Wolfurt Lauterach | Lauterach Wolfurt | 0,77 | 0,1379 | 0,0024 | 0,77 | 0,1379 | 0,0038 | 1,08 | 0,1931 | 0,0056 | 1,08 | 0,1931 | 0,0087 | 1,55 | 0,2207 | 0,0070 | 1,55 | 0,2207 | 0,0110 |
| A14- | Dornbirn Nord Bregenzerwald | Wolfurt Lauterach | 0,30 | 0,0534 | 0,0009 | 0,30 | 0,0534 | 0,0015 | 0,42 | 0,0747 | 0,0021 | 0,42 | 0,0747 | 0,0034 | 0,60 | 0,0854 | 0,0027 | 0,60 | 0,0854 | 0,0043 |
| A14- | Dornbirn Süd Lustenau | Dornbirn Nord Bregenzerwald | 0,83 | 0,1491 | 0,0026 | 0,83 | 0,1491 | 0,0041 | 1,17 | 0,2087 | 0,0060 | 1,17 | 0,2087 | 0,0094 | 1,67 | 0,2385 | 0,0076 | 1,68 | 0,2385 | 0,0119 |
| A14- | Hohenems | Dornbirn Süd Lustenau | 1,17 | 0,2098 | 0,0037 | 1,17 | 0,2098 | 0,0058 | 1,64 | 0,2937 | 0,0084 | 1,64 | 0,2937 | 0,0133 | 2,35 | 0,3356 | 0,0106 | 2,36 | 0,3356 | 0,0167 |
| A14- | Altach Götzis | Hohenems | 0,76 | 0,1368 | 0,0024 | 0,76 | 0,1368 | 0,0038 | 1,07 | 0,1915 | 0,0055 | 1,07 | 0,1915 | 0,0087 | 1,53 | 0,2188 | 0,0069 | 1,54 | 0,2188 | 0,0109 |
| A14- | Götzis | Altach Götzis | 0,58 | 0,1043 | 0,0018 | 0,58 | 0,1043 | 0,0029 | 0,82 | 0,1460 | 0,0042 | 0,82 | 0,1460 | 0,0066 | 1,17 | 0,1668 | 0,0053 | 1,17 | 0,1668 | 0,0083 |
| A14- | Klaus Koblach | Götzis | 0,50 | 0,0906 | 0,0016 | 0,51 | 0,0906 | 0,0025 | 0,71 | 0,1268 | 0,0036 | 0,71 | 0,1268 | 0,0057 | 1,02 | 0,1449 | 0,0046 | 1,02 | 0,1449 | 0,0072 |
| A14- | Rankweil | Klaus Koblach | 0,89 | 0,1592 | 0,0028 | 0,89 | 0,1592 | 0,0044 | 1,24 | 0,2228 | 0,0064 | 1,25 | 0,2228 | 0,0101 | 1,79 | 0,2547 | 0,0081 | 1,79 | 0,2547 | 0,0127 |
| A14- | Feldkirch Frastanz | Rankweil | 1,26 | 0,2267 | 0,0040 | 1,27 | 0,2267 | 0,0062 | 1,77 | 0,3174 | 0,0091 | 1,78 | 0,3174 | 0,0143 | 2,54 | 0,3628 | 0,0115 | 2,55 | 0,3628 | 0,0181 |
| A14- | Nenzing Bludesch | Feldkirch Frastanz | 2,00 | 0,3585 | 0,0063 | 2,00 | 0,3585 | 0,0099 | 2,80 | 0,5019 | 0,0144 | 2,81 | 0,5019 | 0,0227 | 4,02 | 0,5736 | 0,0182 | 4,03 | 0,5736 | 0,0286 |
| A14- | Bludenz Nüziders | Nenzing Bludesch | 1,48 | 0,2662 | 0,0047 | 1,49 | 0,2662 | 0,0073 | 2,08 | 0,3726 | 0,0107 | 2,09 | 0,3726 | 0,0168 | 2,99 | 0,4259 | 0,0135 | 2,99 | 0,4259 | 0,0212 |
| A14- | Brandnertal | Bludenz Nüziders | 0,21 | 0,0370 | 0,0006 | 0,21 | 0,0370 | 0,0010 | 0,29 | 0,0519 | 0,0015 | 0,29 | 0,0519 | 0,0023 | 0,42 | 0,0593 | 0,0019 | 0,42 | 0,0593 | 0,0030 |
| A14- | Bludenz Bürs | Brandnertal | 0,34 | 0,0618 | 0,0011 | 0,35 | 0,0618 | 0,0017 | 0,48 | 0,0865 | 0,0025 | 0,48 | 0,0865 | 0,0039 | 0,69 | 0,0989 | 0,0031 | 0,69 | 0,0989 | 0,0049 |
| A14- | Bludenz Montafon | Bludenz Bürs | 0,49 | 0,087 | | | | | | | | | | | | | | | | |

| | | | | | | | | | | | | | | | | | | | | |
|------|--------------------------------------|--------------------------------------|------|--------|--------|------|--------|--------|------|--------|--------|------|--------|--------|------|--------|--------|------|--------|--------|
| A22- | Strebersdorf | KN Gürtel Nordbrücke | 0,67 | 0,1203 | 0,0021 | 0,67 | 0,1203 | 0,0033 | 0,94 | 0,1684 | 0,0048 | 0,94 | 0,1684 | 0,0076 | 1,35 | 0,1925 | 0,0061 | 1,35 | 0,1925 | 0,0096 |
| A221 | KN Gürtel Nordbrücke | Wien Nordbrücke | 0,20 | 0,0355 | 0,0006 | 0,20 | 0,0355 | 0,0010 | 0,28 | 0,0497 | 0,0014 | 0,28 | 0,0497 | 0,0022 | 0,40 | 0,0568 | 0,0018 | 0,40 | 0,0568 | 0,0028 |
| A221 | Wien Pragerstraße | KN Gürtel Nordbrücke | 0,21 | 0,0382 | 0,0007 | 0,21 | 0,0382 | 0,0011 | 0,30 | 0,0535 | 0,0015 | 0,30 | 0,0535 | 0,0024 | 0,43 | 0,0611 | 0,0019 | 0,43 | 0,0611 | 0,0030 |
| A221 | Wien Neujedlersdorf | Wien Pragerstraße | 0,09 | 0,0167 | 0,0003 | 0,09 | 0,0167 | 0,0005 | 0,13 | 0,0234 | 0,0007 | 0,13 | 0,0234 | 0,0011 | 0,19 | 0,0268 | 0,0008 | 0,19 | 0,0268 | 0,0013 |
| A221 | Brünnerstr/Shuttlewort hstraße | Wien Neujedlersdorf | 0,24 | 0,0424 | 0,0007 | 0,24 | 0,0424 | 0,0012 | 0,33 | 0,0594 | 0,0017 | 0,33 | 0,0594 | 0,0027 | 0,48 | 0,0678 | 0,0022 | 0,48 | 0,0678 | 0,0034 |
| A22- | Korneuburg Ost | Strebersdorf | 1,35 | 0,2424 | 0,0042 | 1,35 | 0,2424 | 0,0067 | 1,90 | 0,3394 | 0,0098 | 1,90 | 0,3394 | 0,0153 | 2,72 | 0,3878 | 0,0123 | 2,72 | 0,3878 | 0,0193 |
| A222 | Wien Vohburggasse | Strebersdorf | 0,17 | 0,0301 | 0,0005 | 0,17 | 0,0301 | 0,0008 | 0,24 | 0,0422 | 0,0012 | 0,24 | 0,0422 | 0,0019 | 0,34 | 0,0482 | 0,0015 | 0,34 | 0,0482 | 0,0024 |
| A22- | KN Korneuburg | Korneuburg Ost | 0,87 | 0,1564 | 0,0027 | 0,87 | 0,1564 | 0,0043 | 1,22 | 0,2190 | 0,0063 | 1,23 | 0,2190 | 0,0099 | 1,75 | 0,2503 | 0,0079 | 1,76 | 0,2503 | 0,0125 |
| A22- | Stockerau Ost | KN Korneuburg | 1,27 | 0,2276 | 0,0040 | 1,27 | 0,2276 | 0,0063 | 1,78 | 0,3186 | 0,0092 | 1,78 | 0,3186 | 0,0144 | 2,55 | 0,3642 | 0,0116 | 2,56 | 0,3642 | 0,0182 |
| A22- | Stockerau Mitte | Stockerau Ost | 0,51 | 0,0908 | 0,0016 | 0,51 | 0,0908 | 0,0025 | 0,71 | 0,1271 | 0,0037 | 0,71 | 0,1271 | 0,0057 | 1,02 | 0,1452 | 0,0046 | 1,02 | 0,1452 | 0,0072 |
| A22- | KN Stockerau/West | Stockerau Mitte | 0,43 | 0,0771 | 0,0013 | 0,43 | 0,0771 | 0,0021 | 0,60 | 0,1079 | 0,0031 | 0,60 | 0,1079 | 0,0049 | 0,86 | 0,1233 | 0,0039 | 0,87 | 0,1233 | 0,0061 |
| A23- | KN Wien Inzersdorf | Altmannsdorferstraße | 0,38 | 0,0674 | 0,0012 | 0,38 | 0,0674 | 0,0019 | 0,53 | 0,0944 | 0,0027 | 0,53 | 0,0944 | 0,0043 | 0,76 | 0,1079 | 0,0034 | 0,76 | 0,1079 | 0,0054 |
| A23- | Favoriten | KN Wien Inzersdorf | 0,95 | 0,1701 | 0,0030 | 0,95 | 0,1701 | 0,0047 | 1,33 | 0,2381 | 0,0068 | 1,33 | 0,2381 | 0,0108 | 1,91 | 0,2721 | 0,0086 | 1,91 | 0,2721 | 0,0136 |
| A23- | KN Gürtel Landstraßer Hauptstraße | Favoriten | 0,59 | 0,1065 | 0,0019 | 0,59 | 0,1065 | 0,0029 | 0,83 | 0,1491 | 0,0043 | 0,84 | 0,1491 | 0,0067 | 1,19 | 0,1704 | 0,0054 | 1,20 | 0,1704 | 0,0085 |
| A23- | St. Marx | KN Gürtel Landstraßer Hauptstraße | 0,23 | 0,0404 | 0,0007 | 0,23 | 0,0404 | 0,0011 | 0,32 | 0,0566 | 0,0016 | 0,32 | 0,0566 | 0,0026 | 0,45 | 0,0647 | 0,0021 | 0,45 | 0,0647 | 0,0032 |
| A23- | KN Wien Prater | St. Marx | 0,19 | 0,0343 | 0,0006 | 0,19 | 0,0343 | 0,0009 | 0,27 | 0,0480 | 0,0014 | 0,27 | 0,0480 | 0,0022 | 0,38 | 0,0549 | 0,0017 | 0,39 | 0,0549 | 0,0027 |
| A23- | Handelskai | KN Wien Prater | 0,42 | 0,0762 | 0,0013 | 0,43 | 0,0762 | 0,0021 | 0,60 | 0,1067 | 0,0031 | 0,60 | 0,1067 | 0,0048 | 0,85 | 0,1219 | 0,0039 | 0,86 | 0,1219 | 0,0061 |
| A23- | KN Wien Kaisermühlen | Handelskai | 0,19 | 0,0348 | 0,0006 | 0,19 | 0,0348 | 0,0010 | 0,27 | 0,0488 | 0,0014 | 0,27 | 0,0488 | 0,0022 | 0,39 | 0,0557 | 0,0018 | 0,39 | 0,0557 | 0,0028 |
| A23- | Groß Enzersdorf Stadlau | KN Wien Kaisermühlen | 0,53 | 0,0956 | 0,0017 | 0,53 | 0,0956 | 0,0026 | 0,75 | 0,1338 | 0,0038 | 0,75 | 0,1338 | 0,0060 | 1,07 | 0,1530 | 0,0049 | 1,08 | 0,1530 | 0,0076 |
| A23- | Hirschstetten | Groß Enzersdorf Stadlau | 0,30 | 0,0536 | 0,0009 | 0,30 | 0,0536 | 0,0015 | 0,42 | 0,0750 | 0,0022 | 0,42 | 0,0750 | 0,0034 | 0,60 | 0,0858 | 0,0027 | 0,60 | 0,0858 | 0,0043 |
| A233 | Wien Gürtel | KN Gürtel Landstraßer Hauptstraße | 0,17 | 0,0313 | 0,0005 | 0,17 | 0,0313 | 0,0009 | 0,24 | 0,0438 | 0,0013 | 0,25 | 0,0438 | 0,0020 | 0,35 | 0,0500 | 0,0016 | 0,35 | 0,0500 | 0,0025 |
| A25- | Weißkirchen | KN A1/A25 Passau Wels | 1,96 | 0,3526 | 0,0062 | 1,97 | 0,3526 | 0,0097 | 2,76 | 0,4936 | 0,0142 | 2,76 | 0,4936 | 0,0223 | 3,95 | 0,5642 | 0,0179 | 3,97 | 0,5642 | 0,0281 |
| A25- | Marchtrenk Wels Ost | Weißkirchen | 0,70 | 0,1256 | 0,0022 | 0,70 | 0,1256 | 0,0035 | 0,98 | 0,1759 | 0,0051 | 0,99 | 0,1759 | 0,0079 | 1,41 | 0,2010 | 0,0064 | 1,41 | 0,2010 | 0,0100 |
| A25- | ÖBB Terminal Wels | Marchtrenk Wels Ost | 0,19 | 0,0338 | 0,0006 | 0,19 | 0,0338 | 0,0009 | 0,26 | 0,0473 | 0,0014 | 0,26 | 0,0473 | 0,0021 | 0,38 | 0,0541 | 0,0017 | 0,38 | 0,0541 | 0,0027 |
| A25- | Wels Nord | ÖBB Terminal Wels | 0,90 | 0,1620 | 0,0028 | 0,90 | 0,1620 | 0,0045 | 1,27 | 0,2269 | 0,0065 | 1,27 | 0,2269 | 0,0102 | 1,82 | 0,2593 | 0,0082 | 1,82 | 0,2593 | 0,0129 |
| A25- | KN Wels | Wels Nord | 0,64 | 0,1153 | 0,0020 | 0,64 | 0,1153 | 0,0032 | 0,90 | 0,1614 | 0,0046 | 0,90 | 0,1614 | 0,0073 | 1,29 | 0,1844 | 0,0059 | 1,30 | 0,1844 | 0,0092 |
| S01- | Vorarlberger Allee | KN Vösendorf | 0,48 | 0,0855 | 0,0015 | 0,48 | 0,0855 | 0,0024 | 0,67 | 0,1197 | 0,0034 | 0,67 | 0,1197 | 0,0054 | 0,96 | 0,1368 | 0,0043 | 0,96 | 0,1368 | 0,0068 |
| S01- | Laxenburger Str. | Vorarlberger Allee | 0,25 | 0,0449 | 0,0008 | 0,25 | 0,0449 | 0,0012 | 0,35 | 0,0628 | 0,0018 | 0,35 | 0,0628 | 0,0028 | 0,50 | 0,0718 | 0,0023 | 0,50 | 0,0718 | 0,0036 |
| S01- | Güterzentrum Wien Süd | Laxenburger Str. | 0,31 | 0,0556 | 0,0010 | 0,31 | 0,0556 | 0,0015 | 0,43 | 0,0779 | 0,0022 | 0,44 | 0,0779 | 0,0035 | 0,62 | 0,0890 | 0,0028 | 0,63 | 0,0890 | 0,0044 |
| S01- | Rothneusiedl | Güterzentrum Wien Süd | 0,20 | 0,0362 | 0,0006 | 0,20 | 0,0362 | 0,0010 | 0,28 | 0,0506 | 0,0015 | 0,28 | 0,0506 | 0,0023 | 0,41 | 0,0579 | 0,0018 | 0,41 | 0,0579 | 0,0029 |
| S01- | KN Rustenfeld | Rothneusiedl | 0,47 | 0,0846 | 0,0015 | 0,47 | 0,0846 | 0,0023 | 0,66 | 0,1184 | 0,0034 | 0,66 | 0,1184 | 0,0054 | 0,95 | 0,1354 | 0,0043 | 0,95 | 0,1354 | 0,0067 |
| S01- | Rannersdorf | KN Rustenfeld | 0,66 | 0,1187 | 0,0021 | 0,66 | 0,1187 | 0,0033 | 0,93 | 0,1662 | 0,0048 | 0,93 | 0,1662 | 0,0075 | 1,33 | 0,1900 | 0,0060 | 1,34 | 0,1900 | 0,0095 |
| S011 | Leopoldsdorf (B16) | KN Rustenfeld | 0,29 | 0,0526 | 0,0009 | 0,29 | 0,0526 | 0,0014 | 0,41 | 0,0736 | 0,0021 | 0,41 | 0,0736 | 0,0033 | 0,59 | 0,0842 | 0,0027 | 0,59 | 0,0842 | 0,0042 |
| S01- | Schwechat Süd | Rannersdorf | 0,52 | 0,0928 | 0,0016 | 0,52 | 0,0928 | 0,0026 | 0,73 | 0,1299 | 0,0037 | 0,73 | 0,1299 | 0,0059 | 1,04 | 0,1484 | 0,0047 | 1,04 | 0,1484 | 0,0074 |
| S01- | Schwechat Ost | Schwechat Süd | 0,30 | 0,0531 | 0,0009 | 0,30 | 0,0531 | 0,0015 | 0,42 | 0,0744 | 0,0021 | 0,42 | 0,0744 | 0,0034 | 0,60 | 0,0850 | 0,0027 | 0,60 | 0,0850 | 0,0042 |
| S01- | Mannswörth | Schwechat Ost | 0,31 | 0,0562 | 0,0010 | 0,31 | 0,0562 | 0,0015 | 0,44 | 0,0787 | 0,0023 | 0,44 | 0,0787 | 0,0036 | 0,63 | 0,0900 | 0,0029 | 0,63 | 0,0900 | 0,0045 |
| S01- | KN Schwechat | Mannswörth | 0,12 | 0,0211 | 0,0004 | 0,12 | 0,0211 | 0,0006 | 0,16 | 0,0295 | 0,0008 | 0,17 | 0,0295 | 0,0013 | 0,24 | 0,0337 | 0,0011 | 0,24 | 0,0337 | 0,0017 |
| S01- | Seyring | Angerner Straße | 1,10 | 0,1971 | 0,0034 | 1,10 | 0,1971 | 0,0054 | 1,54 | 0,2759 | 0,0079 | 1,55 | 0,2759 | 0,0125 | 2,21 | 0,3153 | 0,0100 | 2,22 | 0,3153 | 0,0157 |
| S01- | KN Eibesbrunn | Seyring | 0,92 | 0,1649 | 0,0029 | 0,92 | 0,1649 | 0,0045 | 1,29 | 0,2308 | 0,0066 | 1,29 | 0,2308 | 0,0104 | 1,85 | 0,2638 | 0,0084 | 1,85 | 0,2638 | 0,0131 |
| S01- | Hagenbrunn | KN Eibesbrunn | 0,72 | 0,1298 | 0,0023 | 0,72 | 0,1298 | 0,0036 | 1,01 | 0,1817 | 0,0052 | 1,02 | 0,1817 | 0,0082 | 1,46 | 0,2077 | 0,0066 | 1,46 | 0,2077 | 0,0104 |
| S01- | Korneuburg Nord | Hagenbrunn | 1,55 | 0,2777 | 0,0049 | 1,55 | 0,2777 | 0,0076 | 2,17 | 0,3888 | 0,0112 | 2,18 | 0,3888 | 0,0176 | 3,11 | 0,4443 | 0,0141 | 3,12 | 0,4443 | 0,0221 |
| S01- | Korneuburg West | Korneuburg Nord | 0,63 | 0,1126 | 0,0020 | 0,63 | 0,1126 | 0,0031 | 0,88 | 0,1577 | 0,0045 | 0,88 | 0,1577 | 0,0071 | 1,26 | 0,1802 | 0,0057 | 1,27 | 0,1802 | 0,0090 |
| S01- | KN Korneuburg | Korneuburg West | 0,20 | 0,0359 | 0,0006 | 0,20 | 0,0359 | 0,0010 | 0,28 | 0,0503 | 0,0014 | 0,28 | 0,0503 | 0,0023 | 0,40 | 0,0575 | 0,0018 | 0,40 | 0,0575 | 0,0029 |
| S02- | Gewerbepark Stadlau | Hirschstetten | 0,22 | 0,0386 | 0,0007 | 0,22 | 0,0386 | 0,0011 | 0,30 | 0,0540 | 0,0016 | 0,30 | 0,0540 | 0,0024 | 0,43 | 0,0618 | 0,0020 | 0,43 | 0,0618 | 0,0031 |
| S02- | Breitenleer Straße | Gewerbepark Stadlau | 0,12 | 0,0214 | 0,0004 | 0,12 | 0,0214 | 0,0006 | 0,17 | 0,0300 | 0,0009 | 0,17 | 0,0300 | 0,0014 | 0,24 | 0,0342 | 0,0011 | 0,24 | 0,0342 | 0,0017 |
| S02- | Rautenweg | Breitenleer Straße | 0,20 | 0,0355 | 0,0006 | 0,20 | 0,0355 | 0,0010 | 0,28 | 0,0497 | 0,0014 | 0,28 | 0,0497 | 0,0022 | 0,40 | 0,0568 | 0,0018 | 0,40 | 0,0568 | 0,0028 |
| S02- | Hermann Gebauer Straße | Rautenweg | 0,22 | 0,0390 | 0,0007 | 0,22 | 0,0390 | 0,0011 | 0,31 | 0,0547 | 0,0016 | 0,31 | 0,0547 | 0,0025 | 0,44 | 0,0625 | 0,0020 | 0,44 | 0,0625 | 0,0031 |
| S02- | Angerner Straße | Hermann Gebauer Straße | 0,79 | 0,1413 | 0,0025 | 0,79 | 0,1413 | 0,0039 | 1,10 | 0,1978 | 0,0057 | 1,11 | 0,1978 | 0,0089 | 1,58 | 0,2260 | 0,0072 | 1,59 | 0,2260 | 0,0113 |
| S03- | Stockerau Nord | KN Stockerau/West | 0,22 | 0,0399 | 0,0007 | 0,22 | 0,0399 | 0,0011 | 0,31 | 0,0559 | 0,0016 | 0,31 | 0,0559 | 0,0025 | 0,45 | 0,0639 | 0,0020 | 0,45 | 0,0639 | 0,0032 |
| S03- | Sierndorf | Stockerau Nord | 1,20 | 0,2146 | 0,0038 | 1,20 | 0,2146 | 0,0059 | 1,68 | 0,3004 | 0,0086 | 1,68 | 0,3004 | 0,0136 | 2,41 | 0,3433 | 0,0109 | 2,41 | 0,3433 | 0,0171 |
| S03- | Obermallebarn | Sierndorf | 0,80 | 0,1441 | 0,0025 | 0,80 | 0,1441 | 0,0040 | 1,13 | 0,2017 | 0,0058 | 1,13 | 0,2017 | 0,0091 | 1,62 | 0,2305 | 0,0073 | 1,62 | 0,2305 | 0,0115 |
| S03- | Göllersdorf | Obermallebarn | 1,06 | 0,1902 | 0,0033 | 1,06 | 0,1902 | 0,0052 | 1,49 | 0,2663 | 0,0077 | 1,49 | 0,2663 | 0,0120 | 2,13 | 0,3044 | 0,0097 | 2,14 | 0,3044 | 0,0152 |
| S03- | Großstelzendorf | Göllersdorf | 0,42 | 0,0762 | 0,0013 | 0,43 | 0,0762 | 0,0021 | 0,60 | 0,1067 | 0,0031 | 0,60 | 0,1067 | 0,0048 | 0,85 | 0,1219 | 0,0039 | 0,86 | 0,1219 | 0,0061 |
| S03- | Hollabrunn Süd | Großstelzendorf | 1,02 | 0,1832 | 0,0032 | 1,02 | 0,1832 | 0,0050 | 1,43 | 0,2565 | 0,0074 | 1,44 | 0,2565 | 0,0116 | 2,06 | 0,2932 | 0,0093 | 2,06 | 0,2932 | 0,0146 |
| S04- | Sigleß | KN Mattersburg | 0,53 | 0,0947 | 0,0017 | 0,53 | 0,0947 | 0,0026 | 0,74 | 0,1326 | 0,0038 | 0,74 | 0,1326 | 0,0060 | 1,06 | 0,1516 | 0,0048 | 1,07 | 0,1516 | 0,0076 |
| S04- | Bad Sauerbrunn | Sigleß | 1,23 | 0,2213 | 0,0039 | 1,24 | 0,2213 | 0,0061 | 1,73 | 0,3098 | 0,0089 | 1,74 | 0,3098 | 0,0140 | 2,48 | 0,3541 | 0,0112 | 2,49 | 0,3541 | 0,0177 |
| S04- | | | | | | | | | | | | | | | | | | | | |

| | | | | | | | | | | | | | | | | | | | | |
|------|-----------------------------------|-----------------------------------|------|--------|--------|------|--------|--------|-------|--------|--------|-------|--------|--------|-------|--------|--------|-------|--------|--------|
| S06- | Gloggnitz | Neunkirchen | 2,71 | 0,4868 | 0,0085 | 2,72 | 0,4868 | 0,0134 | 3,81 | 0,6815 | 0,0196 | 3,82 | 0,6815 | 0,0308 | 5,46 | 0,7789 | 0,0247 | 5,47 | 0,7789 | 0,0388 |
| S06- | Maria Schutz | Gloggnitz | 1,73 | 0,3103 | 0,0054 | 1,73 | 0,3103 | 0,0085 | 2,43 | 0,4344 | 0,0125 | 2,43 | 0,4344 | 0,0196 | 3,48 | 0,4964 | 0,0157 | 3,49 | 0,4964 | 0,0247 |
| S06- | Spital / Semmering | Maria Schutz | 1,47 | 0,2634 | 0,0046 | 1,47 | 0,2634 | 0,0072 | 2,06 | 0,3687 | 0,0106 | 2,06 | 0,3687 | 0,0167 | 2,95 | 0,4214 | 0,0134 | 2,96 | 0,4214 | 0,0210 |
| S06- | Mürzzuschlag Ost | Spital / Semmering | 1,23 | 0,2200 | 0,0039 | 1,23 | 0,2200 | 0,0061 | 1,72 | 0,3080 | 0,0089 | 1,72 | 0,3080 | 0,0139 | 2,47 | 0,3520 | 0,0112 | 2,47 | 0,3520 | 0,0175 |
| S06- | Mariazell, Mürzsteg, Mürzzuschlag | Mürzzuschlag Ost | 1,09 | 0,1950 | 0,0034 | 1,09 | 0,1950 | 0,0054 | 1,52 | 0,2731 | 0,0079 | 1,53 | 0,2731 | 0,0123 | 2,19 | 0,3121 | 0,0099 | 2,19 | 0,3121 | 0,0156 |
| S06- | Hönigsberg | Mariazell, Mürzsteg, Mürzzuschlag | 0,78 | 0,1391 | 0,0024 | 0,78 | 0,1391 | 0,0038 | 1,09 | 0,1947 | 0,0056 | 1,09 | 0,1947 | 0,0088 | 1,56 | 0,2225 | 0,0071 | 1,56 | 0,2225 | 0,0111 |
| S06- | Langenwang | Hönigsberg | 0,43 | 0,0769 | 0,0013 | 0,43 | 0,0769 | 0,0021 | 0,60 | 0,1077 | 0,0031 | 0,60 | 0,1077 | 0,0049 | 0,86 | 0,1231 | 0,0039 | 0,87 | 0,1231 | 0,0061 |
| S06- | Krieglach | Langenwang | 0,51 | 0,0914 | 0,0016 | 0,51 | 0,0914 | 0,0025 | 0,71 | 0,1279 | 0,0037 | 0,72 | 0,1279 | 0,0058 | 1,02 | 0,1462 | 0,0046 | 1,03 | 0,1462 | 0,0073 |
| S06- | Mitterdorf | Krieglach | 1,29 | 0,2309 | 0,0040 | 1,29 | 0,2309 | 0,0064 | 1,81 | 0,3233 | 0,0093 | 1,81 | 0,3233 | 0,0146 | 2,59 | 0,3695 | 0,0117 | 2,60 | 0,3695 | 0,0184 |
| S06- | Kindberg Ost | Mitterdorf | 1,31 | 0,2348 | 0,0041 | 1,31 | 0,2348 | 0,0065 | 1,84 | 0,3287 | 0,0095 | 1,84 | 0,3287 | 0,0149 | 2,63 | 0,3757 | 0,0119 | 2,64 | 0,3757 | 0,0187 |
| S06- | Kindberg West | Kindberg Ost | 0,28 | 0,0504 | 0,0009 | 0,28 | 0,0504 | 0,0014 | 0,39 | 0,0706 | 0,0020 | 0,40 | 0,0706 | 0,0032 | 0,57 | 0,0806 | 0,0026 | 0,57 | 0,0806 | 0,0040 |
| S06- | Kindberg Dörfel | Kindberg West | 0,28 | 0,0504 | 0,0009 | 0,28 | 0,0504 | 0,0014 | 0,39 | 0,0705 | 0,0020 | 0,39 | 0,0705 | 0,0032 | 0,56 | 0,0806 | 0,0026 | 0,57 | 0,0806 | 0,0040 |
| S06- | Allerheiligen Mürzhofen | Kindberg Dörfel | 0,63 | 0,1134 | 0,0020 | 0,63 | 0,1134 | 0,0031 | 0,89 | 0,1588 | 0,0046 | 0,89 | 0,1588 | 0,0072 | 1,27 | 0,1815 | 0,0058 | 1,28 | 0,1815 | 0,0090 |
| S06- | St. Marein | Allerheiligen Mürzhofen | 0,95 | 0,1704 | 0,0030 | 0,95 | 0,1704 | 0,0047 | 1,33 | 0,2386 | 0,0069 | 1,34 | 0,2386 | 0,0108 | 1,91 | 0,2726 | 0,0086 | 1,92 | 0,2726 | 0,0136 |
| S06- | Kapfenberg | St. Marein | 0,67 | 0,1208 | 0,0021 | 0,67 | 0,1208 | 0,0033 | 0,94 | 0,1691 | 0,0049 | 0,95 | 0,1691 | 0,0076 | 1,35 | 0,1933 | 0,0061 | 1,36 | 0,1933 | 0,0096 |
| S06- | KN Bruck/Mur | Kapfenberg | 1,26 | 0,2255 | 0,0039 | 1,26 | 0,2255 | 0,0062 | 1,76 | 0,3157 | 0,0091 | 1,77 | 0,3157 | 0,0143 | 2,53 | 0,3608 | 0,0114 | 2,54 | 0,3608 | 0,0180 |
| S06- | ASt Bruck/Mur | KN Bruck/Mur | 1,08 | 0,1934 | 0,0034 | 1,08 | 0,1934 | 0,0053 | 1,51 | 0,2708 | 0,0078 | 1,52 | 0,2708 | 0,0122 | 2,17 | 0,3095 | 0,0098 | 2,18 | 0,3095 | 0,0154 |
| S06- | Niklasdorf | ASt Bruck/Mur | 1,00 | 0,1787 | 0,0031 | 1,00 | 0,1787 | 0,0049 | 1,40 | 0,2502 | 0,0072 | 1,40 | 0,2502 | 0,0113 | 2,00 | 0,2860 | 0,0091 | 2,01 | 0,2860 | 0,0143 |
| S06- | Leoben Ost | Niklasdorf | 1,06 | 0,1906 | 0,0033 | 1,06 | 0,1906 | 0,0052 | 1,49 | 0,2669 | 0,0077 | 1,49 | 0,2669 | 0,0121 | 2,14 | 0,3050 | 0,0097 | 2,14 | 0,3050 | 0,0152 |
| S06- | Leoben West | Leoben Ost | 1,19 | 0,2136 | 0,0037 | 1,19 | 0,2136 | 0,0059 | 1,67 | 0,2990 | 0,0086 | 1,67 | 0,2990 | 0,0135 | 2,40 | 0,3417 | 0,0108 | 2,40 | 0,3417 | 0,0170 |
| S06- | KN St. Michael | Leoben West | 1,47 | 0,2644 | 0,0046 | 1,48 | 0,2644 | 0,0073 | 2,07 | 0,3701 | 0,0106 | 2,07 | 0,3701 | 0,0167 | 2,97 | 0,4230 | 0,0134 | 2,97 | 0,4230 | 0,0211 |
| S10- | Neumarkt | Unterweikersdorf | 1,49 | 0,2679 | 0,0047 | 1,50 | 0,2679 | 0,0074 | 2,09 | 0,3750 | 0,0108 | 2,10 | 0,3750 | 0,0169 | 3,00 | 0,4286 | 0,0136 | 3,01 | 0,4286 | 0,0214 |
| S10- | Kefermarkt | Neumarkt | 0,86 | 0,1538 | 0,0027 | 0,86 | 0,1538 | 0,0042 | 1,20 | 0,2154 | 0,0062 | 1,21 | 0,2154 | 0,0097 | 1,73 | 0,2461 | 0,0078 | 1,73 | 0,2461 | 0,0123 |
| S10- | Freistadt / Süd | Kefermarkt | 0,92 | 0,1655 | 0,0029 | 0,92 | 0,1655 | 0,0046 | 1,29 | 0,2317 | 0,0067 | 1,30 | 0,2317 | 0,0105 | 1,86 | 0,2648 | 0,0084 | 1,86 | 0,2648 | 0,0132 |
| S10- | Grünbach Sandl | Freistadt / Süd | 0,98 | 0,1750 | 0,0031 | 0,98 | 0,1750 | 0,0048 | 1,37 | 0,2451 | 0,0070 | 1,37 | 0,2451 | 0,0111 | 1,96 | 0,2801 | 0,0089 | 1,97 | 0,2801 | 0,0140 |
| S10- | Freistadt / Nord | Grünbach Sandl | 0,27 | 0,0481 | 0,0008 | 0,27 | 0,0481 | 0,0013 | 0,38 | 0,0673 | 0,0019 | 0,38 | 0,0673 | 0,0030 | 0,54 | 0,0769 | 0,0024 | 0,54 | 0,0769 | 0,0038 |
| S16- | Landeck West | Zams | 1,14 | 0,2046 | 0,0036 | 1,14 | 0,2046 | 0,0056 | 1,60 | 0,2864 | 0,0082 | 1,60 | 0,2864 | 0,0129 | 2,29 | 0,3274 | 0,0104 | 2,30 | 0,3274 | 0,0163 |
| S16- | Pians | Landeck West | 0,73 | 0,1310 | 0,0023 | 0,73 | 0,1310 | 0,0036 | 1,02 | 0,1835 | 0,0053 | 1,03 | 0,1835 | 0,0083 | 1,47 | 0,2097 | 0,0067 | 1,47 | 0,2097 | 0,0105 |
| S16- | Flirsch | Pians | 1,45 | 0,2597 | 0,0045 | 1,45 | 0,2597 | 0,0071 | 2,03 | 0,3636 | 0,0105 | 2,04 | 0,3636 | 0,0164 | 2,91 | 0,4156 | 0,0132 | 2,92 | 0,4156 | 0,0207 |
| S16- | Schnann am Arlberg | Flirsch | 0,91 | 0,1630 | 0,0029 | 0,91 | 0,1630 | 0,0045 | 1,27 | 0,2283 | 0,0066 | 1,28 | 0,2283 | 0,0103 | 1,83 | 0,2609 | 0,0083 | 1,83 | 0,2609 | 0,0130 |
| S16- | Pettneu | Schnann am Arlberg | 0,66 | 0,1185 | 0,0021 | 0,66 | 0,1185 | 0,0033 | 0,93 | 0,1659 | 0,0048 | 0,93 | 0,1659 | 0,0075 | 1,33 | 0,1896 | 0,0060 | 1,33 | 0,1896 | 0,0095 |
| S16- | St. Anton/Arlberg | Pettneu | 0,37 | 0,0660 | 0,0012 | 0,37 | 0,0660 | 0,0018 | 0,52 | 0,0924 | 0,0027 | 0,52 | 0,0924 | 0,0042 | 0,74 | 0,1056 | 0,0033 | 0,74 | 0,1056 | 0,0053 |
| S16- | Langen/Arlberg | St. Anton/Arlberg | 8,43 | 0,6421 | 0,0112 | 8,43 | 0,6421 | 0,0177 | 11,81 | 0,8990 | 0,0258 | 11,82 | 0,8990 | 0,0406 | 17,39 | 1,0274 | 0,0326 | 17,41 | 1,0274 | 0,0512 |
| S16- | Wald/Arlberg | Langen/Arlberg | 1,17 | 0,2103 | 0,0037 | 1,17 | 0,2103 | 0,0058 | 1,64 | 0,2944 | 0,0085 | 1,65 | 0,2944 | 0,0133 | 2,36 | 0,3365 | 0,0107 | 2,37 | 0,3365 | 0,0168 |
| S16- | Dalaas | Wald/Arlberg | 1,34 | 0,2396 | 0,0042 | 1,34 | 0,2396 | 0,0066 | 1,87 | 0,3354 | 0,0096 | 1,88 | 0,3354 | 0,0152 | 2,69 | 0,3833 | 0,0122 | 2,69 | 0,3833 | 0,0191 |
| S16- | Braz Ost | Dalaas | 0,76 | 0,1358 | 0,0024 | 0,76 | 0,1358 | 0,0037 | 1,06 | 0,1901 | 0,0055 | 1,06 | 0,1901 | 0,0086 | 1,52 | 0,2173 | 0,0069 | 1,53 | 0,2173 | 0,0108 |
| S16- | Braz West | Braz Ost | 0,59 | 0,1060 | 0,0019 | 0,59 | 0,1060 | 0,0029 | 0,83 | 0,1483 | 0,0043 | 0,83 | 0,1483 | 0,0067 | 1,19 | 0,1695 | 0,0054 | 1,19 | 0,1695 | 0,0085 |
| S16- | Bings | Braz West | 0,80 | 0,1436 | 0,0025 | 0,80 | 0,1436 | 0,0039 | 1,12 | 0,2010 | 0,0058 | 1,13 | 0,2010 | 0,0091 | 1,61 | 0,2297 | 0,0073 | 1,61 | 0,2297 | 0,0114 |
| S16- | Bludenz Montafon | Bings | 0,38 | 0,0680 | 0,0012 | 0,38 | 0,0680 | 0,0019 | 0,53 | 0,0951 | 0,0027 | 0,53 | 0,0951 | 0,0043 | 0,76 | 0,1087 | 0,0034 | 0,76 | 0,1087 | 0,0054 |
| S31- | Eisenstadt Süd | Eisenstadt Ost | 0,69 | 0,1232 | 0,0022 | 0,69 | 0,1232 | 0,0034 | 0,96 | 0,1724 | 0,0050 | 0,97 | 0,1724 | 0,0078 | 1,38 | 0,1971 | 0,0063 | 1,39 | 0,1971 | 0,0098 |
| S31- | Eisenstadt Mitte | Eisenstadt Süd | 0,26 | 0,0461 | 0,0008 | 0,26 | 0,0461 | 0,0013 | 0,36 | 0,0646 | 0,0019 | 0,36 | 0,0646 | 0,0029 | 0,52 | 0,0738 | 0,0023 | 0,52 | 0,0738 | 0,0037 |
| S31- | KN Eisenstadt | Eisenstadt Mitte | 0,42 | 0,0761 | 0,0013 | 0,42 | 0,0761 | 0,0021 | 0,59 | 0,1065 | 0,0031 | 0,60 | 0,1065 | 0,0048 | 0,85 | 0,1217 | 0,0039 | 0,86 | 0,1217 | 0,0061 |
| S31- | Wulkaprodersdorf | KN Eisenstadt | 0,56 | 0,1013 | 0,0018 | 0,57 | 0,1013 | 0,0028 | 0,79 | 0,1418 | 0,0041 | 0,79 | 0,1418 | 0,0064 | 1,14 | 0,1620 | 0,0051 | 1,14 | 0,1620 | 0,0081 |
| S31- | KN Mattersburg | Wulkaprodersdorf | 1,60 | 0,2875 | 0,0050 | 1,61 | 0,2875 | 0,0079 | 2,25 | 0,4025 | 0,0116 | 2,25 | 0,4025 | 0,0182 | 3,22 | 0,4600 | 0,0146 | 3,23 | 0,4600 | 0,0229 |
| S31- | Forchtenstein | KN Mattersburg | 1,16 | 0,2081 | 0,0036 | 1,16 | 0,2081 | 0,0057 | 1,63 | 0,2914 | 0,0084 | 1,63 | 0,2914 | 0,0132 | 2,33 | 0,3330 | 0,0106 | 2,34 | 0,3330 | 0,0166 |
| S31- | Sieggraben | Forchtenstein | 1,62 | 0,2908 | 0,0051 | 1,62 | 0,2908 | 0,0080 | 2,27 | 0,4071 | 0,0117 | 2,28 | 0,4071 | 0,0184 | 3,26 | 0,4653 | 0,0148 | 3,27 | 0,4653 | 0,0232 |
| S31- | Weppersdorf/Kobersdorf | Sieggraben | 1,95 | 0,3503 | 0,0061 | 1,96 | 0,3503 | 0,0096 | 2,74 | 0,4904 | 0,0141 | 2,75 | 0,4904 | 0,0222 | 3,93 | 0,5605 | 0,0178 | 3,94 | 0,5605 | 0,0279 |
| S31- | Weppersdorf/Markt St.Martin | Weppersdorf/Kobersdorf | 0,40 | 0,0720 | 0,0013 | 0,40 | 0,0720 | 0,0020 | 0,56 | 0,1007 | 0,0029 | 0,56 | 0,1007 | 0,0046 | 0,81 | 0,1151 | 0,0037 | 0,81 | 0,1151 | 0,0057 |
| S31- | Neutal | Weppersdorf/Markt St.Martin | 0,93 | 0,1663 | 0,0029 | 0,93 | 0,1663 | 0,0046 | 1,30 | 0,2328 | 0,0067 | 1,30 | 0,2328 | 0,0105 | 1,87 | 0,2660 | 0,0084 | 1,87 | 0,2660 | 0,0133 |
| S31- | Stoob Süd | Neutal | 0,81 | 0,1453 | 0,0025 | 0,81 | 0,1453 | 0,0040 | 1,14 | 0,2034 | 0,0058 | 1,14 | 0,2034 | 0,0092 | 1,63 | 0,2324 | 0,0074 | 1,63 | 0,2324 | 0,0116 |
| S31- | Oberpullendorf | Stoob Süd | 0,88 | 0,1586 | 0,0028 | 0,89 | 0,1586 | 0,0044 | 1,24 | 0,2220 | 0,0064 | 1,24 | 0,2220 | 0,0100 | 1,78 | 0,2538 | 0,0080 | 1,78 | 0,2538 | 0,0126 |
| S33- | St. Pölten Ost | KN St. Pölten | 0,48 | 0,0861 | 0,0015 | 0,48 | 0,0861 | 0,0024 | 0,67 | 0,1205 | 0,0035 | 0,67 | 0,1205 | 0,0054 | 0,97 | 0,1377 | 0,0044 | 0,97 | 0,1377 | 0,0069 |
| S33- | St. Pölten Nord | St. Pölten Ost | 0,85 | 0,1521 | 0,0027 | 0,85 | 0,1521 | 0,0042 | 1,19 | 0,2130 | 0,0061 | 1,19 | 0,2130 | 0,0096 | 1,71 | 0,2434 | 0,0077 | 1,71 | 0,2434 | 0,0121 |
| S33- | Herzogenburg Süd | St. Pölten Nord | 0,90 | 0,1611 | 0,0028 | 0,90 | 0,1611 | 0,0044 | 1,26 | 0,2255 | 0,0065 | 1,26 | 0,2255 | 0,0102 | 1,81 | 0,2577 | 0,0082 | 1,81 | 0,2577 | 0,0128 |
| S33- | Herzogenburg Stadt | Herzogenburg Süd | 0,48 | 0,0860 | 0,0015 | 0,48 | 0,0860 | 0,0024 | 0,67 | 0,1204 | 0,0035 | 0,67 | 0,1204 | 0,0054 | 0,96 | 0,1376 | 0,0044 | 0,97 | 0,1376 | 0,0069 |
| S33- | Herzogenburg Nord | Herzogenburg Stadt | 0,27 | 0,0477 | 0,0008 | 0,27 | 0,0477 | 0,0013 | 0,37 | 0,0668 | 0,0019 | 0,37 | 0,0668 | 0,0030 | 0,53 | 0,0763 | 0,0024 | 0,54 | 0,0763 | 0,0038 |
| S33- | Traismauer Süd | Herzogenburg Nord | 1,29 | 0,2320 | 0,0041 | 1,30 | 0,2320 | 0,0064 | 1,81 | | | | | | | | | | | |

| | | | | | | | | | | | | | | | | | | | | |
|------|--------------------------|--------------------------|------|--------|--------|------|--------|--------|------|--------|--------|------|--------|--------|------|--------|--------|------|--------|--------|
| S36- | Zeltweg Ost Spielberg | Knittelfeld West | 0,21 | 0,0370 | 0,0006 | 0,21 | 0,0370 | 0,0010 | 0,29 | 0,0518 | 0,0015 | 0,29 | 0,0518 | 0,0023 | 0,42 | 0,0592 | 0,0019 | 0,42 | 0,0592 | 0,0030 |
| S36- | Zeltweg West | Zeltweg Ost Spielberg | 1,34 | 0,2408 | 0,0042 | 1,34 | 0,2408 | 0,0066 | 1,88 | 0,3371 | 0,0097 | 1,89 | 0,3371 | 0,0152 | 2,70 | 0,3853 | 0,0122 | 2,71 | 0,3853 | 0,0192 |
| S36- | Judenburg Ost Fohnsdorf | Zeltweg West | 0,67 | 0,1211 | 0,0021 | 0,68 | 0,1211 | 0,0033 | 0,95 | 0,1695 | 0,0049 | 0,95 | 0,1695 | 0,0077 | 1,36 | 0,1937 | 0,0061 | 1,36 | 0,1937 | 0,0097 |
| S36- | Judenburg West | Judenburg Ost Fohnsdorf | 1,05 | 0,1878 | 0,0033 | 1,05 | 0,1878 | 0,0052 | 1,47 | 0,2630 | 0,0076 | 1,47 | 0,2630 | 0,0119 | 2,11 | 0,3005 | 0,0095 | 2,11 | 0,3005 | 0,0150 |
| S36- | St. Georgen Ost | As B317 (prov.) | 0,11 | 0,0196 | 0,0003 | 0,11 | 0,0196 | 0,0005 | 0,15 | 0,0275 | 0,0008 | 0,15 | 0,0275 | 0,0012 | 0,22 | 0,0314 | 0,0010 | 0,22 | 0,0314 | 0,0016 |
| S36- | St. Georgen West | St. Georgen Ost | 0,20 | 0,0364 | 0,0006 | 0,20 | 0,0364 | 0,0010 | 0,28 | 0,0509 | 0,0015 | 0,29 | 0,0509 | 0,0023 | 0,41 | 0,0582 | 0,0018 | 0,41 | 0,0582 | 0,0029 |
| S37- | St. Veit Mitte / Brückl | St. Veit Nord | 0,63 | 0,1139 | 0,0020 | 0,64 | 0,1139 | 0,0031 | 0,89 | 0,1595 | 0,0046 | 0,89 | 0,1595 | 0,0072 | 1,28 | 0,1823 | 0,0058 | 1,28 | 0,1823 | 0,0091 |
| S37- | St. Veit Süd | St. Veit Mitte / Brückl | 0,54 | 0,0968 | 0,0017 | 0,54 | 0,0968 | 0,0027 | 0,76 | 0,1356 | 0,0039 | 0,76 | 0,1356 | 0,0061 | 1,09 | 0,1549 | 0,0049 | 1,09 | 0,1549 | 0,0077 |
| S37- | St. Veit Industriegebiet | St. Veit Süd | 0,41 | 0,0728 | 0,0013 | 0,41 | 0,0728 | 0,0020 | 0,57 | 0,1019 | 0,0029 | 0,57 | 0,1019 | 0,0046 | 0,82 | 0,1165 | 0,0037 | 0,82 | 0,1165 | 0,0058 |
| S37- | Maria Saal | St. Veit Industriegebiet | 1,42 | 0,2555 | 0,0045 | 1,43 | 0,2555 | 0,0070 | 2,00 | 0,3577 | 0,0103 | 2,00 | 0,3577 | 0,0162 | 2,87 | 0,4088 | 0,0130 | 2,87 | 0,4088 | 0,0204 |
| S37- | Karnburg | Maria Saal | 0,51 | 0,0912 | 0,0016 | 0,51 | 0,0912 | 0,0025 | 0,71 | 0,1277 | 0,0037 | 0,72 | 0,1277 | 0,0058 | 1,02 | 0,1460 | 0,0046 | 1,03 | 0,1460 | 0,0073 |
| S37- | Klagenfurt Nord | Karnburg | 0,44 | 0,0796 | 0,0014 | 0,44 | 0,0796 | 0,0022 | 0,62 | 0,1115 | 0,0032 | 0,62 | 0,1115 | 0,0050 | 0,89 | 0,1274 | 0,0040 | 0,90 | 0,1274 | 0,0064 |

| Road | Toll road section from | Toll road section to | EURO II Cat 2 | | | | | | EURO II Cat 3 | | | | | | EURO II Cat 4 | | | | | |
|------|----------------------------|----------------------------|---------------|--------|--------|-------|--------|--------|---------------|--------|--------|-------|--------|--------|---------------|--------|--------|-------|--------|--------|
| | | | Unit Price | | | | | | Unit Price | | | | | | Unit Price | | | | | |
| | | | Day | | | Night | | | Day | | | Night | | | Day | | | Night | | |
| | | | Sum | Air | Noise | Sum | Air | Noise | Sum | Air | Noise | Sum | Air | Noise | Sum | Air | Noise | Sum | Air | Noise |
| A01- | Wien Auhof | Preßbaum | 3,11 | 0,5572 | 0,0098 | 3,11 | 0,5572 | 0,0153 | 4,36 | 0,7801 | 0,0224 | 4,37 | 0,7801 | 0,0352 | 6,25 | 0,8915 | 0,0283 | 6,27 | 0,8915 | 0,0444 |
| A01- | Preßbaum | KN Steinhäusl | 1,75 | 0,3149 | 0,0055 | 1,76 | 0,3149 | 0,0087 | 2,46 | 0,4408 | 0,0127 | 2,47 | 0,4408 | 0,0199 | 3,53 | 0,5038 | 0,0160 | 3,54 | 0,5038 | 0,0251 |
| A01- | KN Steinhäusl | Altengbach | 1,03 | 0,1851 | 0,0032 | 1,03 | 0,1851 | 0,0051 | 1,45 | 0,2592 | 0,0075 | 1,45 | 0,2592 | 0,0117 | 2,08 | 0,2962 | 0,0094 | 2,08 | 0,2962 | 0,0148 |
| A01- | Altengbach | St. Christoph | 1,23 | 0,2208 | 0,0039 | 1,23 | 0,2208 | 0,0061 | 1,73 | 0,3091 | 0,0089 | 1,73 | 0,3091 | 0,0140 | 2,48 | 0,3532 | 0,0112 | 2,48 | 0,3532 | 0,0176 |
| A01- | St. Christoph | Böheimkirchen | 1,48 | 0,2648 | 0,0046 | 1,48 | 0,2648 | 0,0073 | 2,07 | 0,3707 | 0,0107 | 2,08 | 0,3707 | 0,0167 | 2,97 | 0,4236 | 0,0134 | 2,98 | 0,4236 | 0,0211 |
| A01- | Böheimkirchen | KN St. Pölten | 1,44 | 0,2590 | 0,0045 | 1,45 | 0,2590 | 0,0071 | 2,02 | 0,3626 | 0,0104 | 2,03 | 0,3626 | 0,0164 | 2,91 | 0,4144 | 0,0131 | 2,91 | 0,4144 | 0,0207 |
| A01- | KN St. Pölten | St. Pölten Süd | 1,02 | 0,1837 | 0,0032 | 1,03 | 0,1837 | 0,0051 | 1,44 | 0,2572 | 0,0074 | 1,44 | 0,2572 | 0,0116 | 2,06 | 0,2940 | 0,0093 | 2,07 | 0,2940 | 0,0147 |
| A01- | St. Pölten Süd | Loosdorf | 3,55 | 0,6371 | 0,0111 | 3,56 | 0,6371 | 0,0175 | 4,98 | 0,8920 | 0,0256 | 5,00 | 0,8920 | 0,0403 | 7,15 | 1,0194 | 0,0323 | 7,16 | 1,0194 | 0,0508 |
| A01- | Loosdorf | Melk | 1,30 | 0,2334 | 0,0041 | 1,30 | 0,2334 | 0,0064 | 1,82 | 0,3268 | 0,0094 | 1,83 | 0,3268 | 0,0148 | 2,62 | 0,3735 | 0,0118 | 2,63 | 0,3735 | 0,0186 |
| A01- | Melk | Pöchlarn | 2,31 | 0,4138 | 0,0072 | 2,31 | 0,4138 | 0,0114 | 3,24 | 0,5794 | 0,0167 | 3,24 | 0,5794 | 0,0262 | 4,64 | 0,6621 | 0,0210 | 4,65 | 0,6621 | 0,0330 |
| A01- | Pöchlarn | Ybbs Wieselburg | 2,13 | 0,3819 | 0,0067 | 2,13 | 0,3819 | 0,0105 | 2,99 | 0,5346 | 0,0154 | 2,99 | 0,5346 | 0,0242 | 4,28 | 0,6110 | 0,0194 | 4,29 | 0,6110 | 0,0305 |
| A01- | Ybbs Wieselburg | Amstetten Ost | 1,91 | 0,3432 | 0,0060 | 1,92 | 0,3432 | 0,0094 | 2,68 | 0,4804 | 0,0138 | 2,69 | 0,4804 | 0,0217 | 3,85 | 0,5491 | 0,0174 | 3,86 | 0,5491 | 0,0274 |
| A01- | Amstetten Ost | Amstetten West | 3,01 | 0,5398 | 0,0094 | 3,01 | 0,5398 | 0,0148 | 4,22 | 0,7557 | 0,0217 | 4,23 | 0,7557 | 0,0341 | 6,05 | 0,8636 | 0,0274 | 6,07 | 0,8636 | 0,0430 |
| A01- | Amstetten West | Oed | 2,11 | 0,3790 | 0,0066 | 2,12 | 0,3790 | 0,0104 | 2,96 | 0,5305 | 0,0153 | 2,97 | 0,5305 | 0,0240 | 4,25 | 0,6063 | 0,0192 | 4,26 | 0,6063 | 0,0302 |
| A01- | Oed | Haag | 2,28 | 0,4090 | 0,0072 | 2,28 | 0,4090 | 0,0112 | 3,20 | 0,5726 | 0,0165 | 3,21 | 0,5726 | 0,0259 | 4,59 | 0,6544 | 0,0208 | 4,60 | 0,6544 | 0,0326 |
| A01- | Haag | St. Valentin | 2,03 | 0,3642 | 0,0064 | 2,03 | 0,3642 | 0,0100 | 2,85 | 0,5099 | 0,0147 | 2,86 | 0,5099 | 0,0230 | 4,09 | 0,5827 | 0,0185 | 4,10 | 0,5827 | 0,0290 |
| A01- | St. Valentin | Enns Steyr | 0,86 | 0,1544 | 0,0027 | 0,86 | 0,1544 | 0,0042 | 1,21 | 0,2162 | 0,0062 | 1,21 | 0,2162 | 0,0098 | 1,73 | 0,2470 | 0,0078 | 1,74 | 0,2470 | 0,0123 |
| A01- | Enns Steyr | Enns West | 0,67 | 0,1198 | 0,0021 | 0,67 | 0,1198 | 0,0033 | 0,94 | 0,1677 | 0,0048 | 0,94 | 0,1677 | 0,0076 | 1,34 | 0,1916 | 0,0061 | 1,35 | 0,1916 | 0,0096 |
| A01- | Enns West | Asten St Florian | 0,52 | 0,0930 | 0,0016 | 0,52 | 0,0930 | 0,0026 | 0,73 | 0,1302 | 0,0037 | 0,73 | 0,1302 | 0,0059 | 1,04 | 0,1488 | 0,0047 | 1,05 | 0,1488 | 0,0074 |
| A01- | Asten St Florian | KN Linz | 1,98 | 0,3562 | 0,0098 | 1,99 | 0,3562 | 0,0098 | 2,78 | 0,4986 | 0,0143 | 2,79 | 0,4986 | 0,0225 | 3,99 | 0,5699 | 0,0181 | 4,01 | 0,5699 | 0,0284 |
| A01- | KN Linz | Ansfelden | 0,33 | 0,0600 | 0,0011 | 0,34 | 0,0600 | 0,0017 | 0,47 | 0,0841 | 0,0024 | 0,47 | 0,0841 | 0,0038 | 0,67 | 0,0961 | 0,0030 | 0,68 | 0,0961 | 0,0048 |
| A01- | Ansfelden | Traun | 0,74 | 0,1329 | 0,0023 | 0,74 | 0,1329 | 0,0037 | 1,04 | 0,1860 | 0,0053 | 1,04 | 0,1860 | 0,0084 | 1,49 | 0,2126 | 0,0067 | 1,49 | 0,2126 | 0,0106 |
| A01- | Traun | KN A1/A25 Passau Wels | 0,35 | 0,0625 | 0,0011 | 0,35 | 0,0625 | 0,0017 | 0,49 | 0,0875 | 0,0025 | 0,49 | 0,0875 | 0,0040 | 0,70 | 0,1000 | 0,0032 | 0,70 | 0,1000 | 0,0050 |
| A01- | KN A1/A25 Passau Wels | Allhaming | 1,61 | 0,2883 | 0,0050 | 1,61 | 0,2883 | 0,0079 | 2,25 | 0,4036 | 0,0116 | 2,26 | 0,4036 | 0,0182 | 3,23 | 0,4612 | 0,0146 | 3,24 | 0,4612 | 0,0230 |
| A01- | Allhaming | Sattledt | 2,68 | 0,4810 | 0,0084 | 2,69 | 0,4810 | 0,0132 | 3,76 | 0,6733 | 0,0194 | 3,77 | 0,6733 | 0,0304 | 5,39 | 0,7695 | 0,0244 | 5,41 | 0,7695 | 0,0384 |
| A01- | Sattledt | KN Voralpenkreuz | 0,34 | 0,0605 | 0,0011 | 0,34 | 0,0605 | 0,0017 | 0,47 | 0,0847 | 0,0024 | 0,47 | 0,0847 | 0,0038 | 0,68 | 0,0968 | 0,0031 | 0,68 | 0,0968 | 0,0048 |
| A01- | KN Voralpenkreuz | Eberstalzell | 0,97 | 0,1741 | 0,0030 | 0,97 | 0,1741 | 0,0048 | 1,36 | 0,2438 | 0,0070 | 1,37 | 0,2438 | 0,0110 | 1,95 | 0,2786 | 0,0088 | 1,96 | 0,2786 | 0,0139 |
| A01- | Eberstalzell | Vorchdorf | 1,46 | 0,2626 | 0,0046 | 1,47 | 0,2626 | 0,0072 | 2,05 | 0,3676 | 0,0106 | 2,06 | 0,3676 | 0,0166 | 2,94 | 0,4201 | 0,0133 | 2,95 | 0,4201 | 0,0209 |
| A01- | Vorchdorf | Laakirchen Ost | 1,28 | 0,2300 | 0,0040 | 1,28 | 0,2300 | 0,0063 | 1,80 | 0,3221 | 0,0093 | 1,80 | 0,3221 | 0,0146 | 2,58 | 0,3681 | 0,0117 | 2,59 | 0,3681 | 0,0183 |
| A01- | Laakirchen Ost | Laakirchen West | 0,81 | 0,1448 | 0,0025 | 0,81 | 0,1448 | 0,0040 | 1,13 | 0,2027 | 0,0058 | 1,14 | 0,2027 | 0,0092 | 1,62 | 0,2317 | 0,0073 | 1,63 | 0,2317 | 0,0115 |
| A01- | Laakirchen West | Regau | 1,58 | 0,2838 | 0,0050 | 1,58 | 0,2838 | 0,0078 | 2,22 | 0,3974 | 0,0114 | 2,23 | 0,3974 | 0,0180 | 3,18 | 0,4541 | 0,0144 | 3,19 | 0,4541 | 0,0226 |
| A01- | Regau | Schörfling | 2,08 | 0,3730 | 0,0065 | 2,08 | 0,3730 | 0,0103 | 2,92 | 0,5221 | 0,0150 | 2,92 | 0,5221 | 0,0236 | 4,18 | 0,5967 | 0,0189 | 4,19 | 0,5967 | 0,0297 |
| A01- | Schörfling | Seewalchen | 0,32 | 0,0578 | 0,0010 | 0,32 | 0,0578 | 0,0016 | 0,45 | 0,0809 | 0,0023 | 0,45 | 0,0809 | 0,0037 | 0,65 | 0,0925 | 0,0029 | 0,65 | 0,0925 | 0,0046 |
| A01- | Seewalchen | St. Georgen | 1,88 | 0,3381 | 0,0059 | 1,89 | 0,3381 | 0,0093 | 2,64 | 0,4733 | 0,0136 | 2,65 | 0,4733 | 0,0214 | 3,79 | 0,5409 | 0,0172 | 3,80 | 0,5409 | 0,0270 |
| A01- | St. Georgen | Oberwang | 2,51 | 0,4508 | 0,0079 | 2,52 | 0,4508 | 0,0124 | 3,52 | 0,6311 | 0,0181 | 3,53 | 0,6311 | 0,0285 | 5,06 | 0,7213 | 0,0229 | 5,07 | 0,7213 | 0,0360 |
| A01- | Oberwang | Mondsee | 2,31 | 0,4149 | 0,0073 | 2,32 | 0,4149 | 0,0114 | 3,24 | 0,5809 | 0,0167 | 3,25 | 0,5809 | 0,0262 | 4,65 | 0,6639 | 0,0211 | 4,67 | 0,6639 | 0,0331 |
| A01- | Mondsee | Thalgau | 2,13 | 0,3825 | 0,0067 | 2,14 | 0,3825 | 0,0105 | 2,99 | 0,5355 | 0,0154 | 3,00 | 0,5355 | 0,0242 | 4,29 | 0,6120 | 0,0194 | 4,30 | 0,6120 | 0,0305 |
| A01- | Thalgau | Wallersee | 1,62 | 0,2915 | 0,0051 | 1,63 | 0,2915 | 0,0080 | 2,28 | 0,4081 | 0,0117 | 2,29 | 0,4081 | 0,0184 | 3,27 | 0,4664 | 0,0148 | 3,28 | 0,4664 | 0,0232 |
| A01- | Wallersee | Salzburg Nord | 1,57 | 0,2822 | 0,0049 | 1,58 | 0,2822 | 0,0078 | 2,21 | 0,3950 | 0,0114 | 2,21 | 0,3950 | 0,0178 | 3,16 | 0,4515 | 0,0143 | 3,17 | 0,4515 | 0,0225 |
| A01- | Salzburg Nord | Salzburg Bergheim-West | 0,35 | 0,0636 | 0,0011 | 0,36 | 0,0636 | 0,0017 | 0,50 | 0,0890 | 0,0026 | 0,50 | 0,0890 | 0,0040 | 0,71 | 0,1018 | 0,0032 | 0,72 | 0,1018 | 0,0051 |
| A01- | Salzburg Bergheim-West | Messe | 0,17 | 0,0304 | 0,0005 | 0,17 | 0,0304 | 0,0008 | 0,24 | 0,0426 | 0,0012 | 0,24 | 0,0426 | 0,0019 | 0,34 | 0,0487 | 0,0015 | 0,34 | 0,0487 | 0,0024 |
| A01- | Messe | Salzburg Mitte Freilassing | 0,23 | 0,0405 | 0,0007 | 0,23 | 0,0405 | 0,0011 | 0,32 | 0,0567 | 0,0016 | 0,32 | 0,0567 | 0,0026 | 0,45 | 0,0648 | 0,0021 | 0,46 | 0,0648 | 0,0032 |
| A01- | Salzburg Mitte Freilassing | Kleßheim | 0,28 | 0,0497 | 0,0009 | 0,28 | 0,0497 | 0,0014 | 0,39 | 0,0696 | 0,0020 | 0,39 | 0,0696 | 0,0031 | 0,56 | 0,0796 | 0,0025 | 0,56 | 0,0796 | 0,0040 |
| A01- | Kleßheim | Siezenheim | 0,38 | 0,0689 | 0,0012 | 0,38 | 0,0689 | 0,0019 | 0,54 | 0,0965 | 0,0028 | 0,54 | 0,0965 | 0,0044 | 0,77 | 0,1103 | 0,0035 | 0,78 | 0,1103 | 0,0055 |
| A01- | Siezenheim | Flughafen | 0,19 | 0,0346 | 0,0006 | 0,19 | 0,0346 | 0,0010 | 0,27 | 0,0485 | 0,0014 | 0,27 | 0,0485 | 0,0022 | 0,39 | 0,0554 | 0,0018 | 0,39 | 0,0554 | 0,0028 |
| A01- | Flughafen | Wals Salzburg West | 0,24 | 0,0424 | 0,0007 | 0,24 | 0,0424 | 0,0012 | 0,33 | 0,0593 | 0,0017 | 0,33 | 0,0593 | 0,0027 | 0,48 | 0,0678 | 0,0021 | 0,48 | 0,0678 | 0,0034 |
| A01- | Wals Salzburg West | KN Salzburg | 0,35 | 0,0634 | 0,0011 | 0,35 | 0,0634 | 0,0017 | 0,50 | 0,0888 | 0,0026 | 0,50 | 0,0888 | 0,0040 | 0,71 | 0,1014 | 0,0032 | 0,71 | 0,1014 | 0,0051 |
| A01- | KN Salzburg | Staatsgrenze Walsberg | 0,60 | 0,1077 | 0,0019 | 0,60 | 0,1077 | 0,0030 | 0,84 | 0,1508 | 0,0043 | 0,84 | 0,1508 | 0,0068 | 1,21 | 0,1724 | 0,0055 | 1,21 | 0,1724 | 0,0086 |
| A02- | KN Wien Inzersdorf | KN Vösendorf | 0,75 | 0,1348 | 0,0024 | 0,75 | 0,1348 | 0,0037 | 1,05 | 0,1887 | 0,0054 | 1,06 | 0,1887 | 0,0085 | 1,51 | 0,2157 | 0,0068 | 1,52 | 0,2157 | 0,0108 |
| A02- | KN Vösendorf | Mödling | 0,51 | 0,0916 | 0,0016 | 0,51 | 0,0916 | 0,0025 | 0,72 | 0,1283 | 0,0037 | 0,72 | 0,1283 | 0,0058 | 1,03 | 0,1466 | 0,0047 | 1,03 | 0,1466 | 0,0073 |
| A02- | Mödling | Wr. Neudorf | 0,49 | 0,0874 | 0,0015 | 0,49 | 0,0874 | 0,0024 | 0,68 | 0,1224 | 0,0035 | 0,69 | 0,1224 | 0,0055 | 0,98 | 0,1399 | 0,0044 | 0,98 | 0,1399 | 0,0070 |
| A02- | Wr. Neudorf | Wr. Neudorf IZ/Süd | 0,54 | 0,0962 | 0,0017 | 0,54 | 0,0962 | 0,0026 | 0,75 | 0,1347 | 0,0039 | 0,75 | 0,1347 | 0,0061 | 1,08 | 0,1539 | 0,0049 | 1,08 | 0,1539 | 0,0077 |
| A02- | Wr. Neudorf IZ/Süd | KN Guntramsdorf | 0,78 | 0,1402 | 0,0025 | 0,78 | 0,1402 | 0,0039 | 1,10 | 0,1963 | 0,0056 | 1,10 | 0,1963 | 0,0089 | 1,57 | 0,2244 | 0,0071 | 1,58 | 0,2244 | 0,0112 |
| A02- | KN Guntramsdorf | Traiskirchen | 0,87 | 0,1562 | 0,0027 | 0,87 | 0,1562 | 0,0043 | 1,22 | 0,2186 | 0,0063 | 1,22 | 0,2186 | 0,0099 | 1,75 | 0,2499 | 0,0079 | 1,76 | 0,2499 | 0,0125 |
| A02- | Traiskirchen | Baden | 0,48 | 0,0869 | 0,0015 | 0,49 | 0,0869 | 0,0 | | | | | | | | | | | | |

| | | | | | | | | | | | | | | | | | | | | |
|------|----------------------------|---------------------------------------|------|--------|--------|------|--------|--------|------|--------|--------|------|--------|--------|------|--------|--------|------|--------|--------|
| A02- | Ilz Fürstenfeld | Sinabelkirchen | 2,50 | 0,4493 | 0,0079 | 2,51 | 0,4493 | 0,0124 | 3,51 | 0,6290 | 0,0181 | 3,52 | 0,6290 | 0,0284 | 5,04 | 0,7189 | 0,0228 | 5,05 | 0,7189 | 0,0358 |
| A02- | Sinabelkirchen | Gleisdorf Süd | 1,65 | 0,2960 | 0,0052 | 1,65 | 0,2960 | 0,0081 | 2,31 | 0,4144 | 0,0119 | 2,32 | 0,4144 | 0,0187 | 3,32 | 0,4736 | 0,0150 | 3,33 | 0,4736 | 0,0236 |
| A02- | Gleisdorf Süd | Gleisdorf West | 0,72 | 0,1285 | 0,0022 | 0,72 | 0,1285 | 0,0035 | 1,00 | 0,1799 | 0,0052 | 1,01 | 0,1799 | 0,0081 | 1,44 | 0,2056 | 0,0065 | 1,44 | 0,2056 | 0,0102 |
| A02- | Gleisdorf West | Laßnitzhöhe | 1,88 | 0,3366 | 0,0059 | 1,88 | 0,3366 | 0,0093 | 2,63 | 0,4713 | 0,0135 | 2,64 | 0,4713 | 0,0213 | 3,78 | 0,5386 | 0,0171 | 3,79 | 0,5386 | 0,0268 |
| A02- | Laßnitzhöhe | KN Graz Ost | 2,35 | 0,4212 | 0,0074 | 2,35 | 0,4212 | 0,0116 | 3,29 | 0,5896 | 0,0170 | 3,30 | 0,5896 | 0,0266 | 4,72 | 0,6739 | 0,0214 | 4,74 | 0,6739 | 0,0336 |
| A02- | KN Graz Ost | Graz Feldkirchen Flughafen | 0,84 | 0,1515 | 0,0027 | 0,85 | 0,1515 | 0,0042 | 1,18 | 0,2121 | 0,0061 | 1,19 | 0,2121 | 0,0096 | 1,70 | 0,2424 | 0,0077 | 1,70 | 0,2424 | 0,0121 |
| A02- | Graz Feldkirchen Flughafen | KN Graz West | 0,57 | 0,1014 | 0,0018 | 0,57 | 0,1014 | 0,0028 | 0,79 | 0,1420 | 0,0041 | 0,80 | 0,1420 | 0,0064 | 1,14 | 0,1623 | 0,0051 | 1,14 | 0,1623 | 0,0081 |
| A02- | KN Graz West | Unterpremstätten | 0,68 | 0,1220 | 0,0021 | 0,68 | 0,1220 | 0,0034 | 0,95 | 0,1707 | 0,0049 | 0,96 | 0,1707 | 0,0077 | 1,37 | 0,1951 | 0,0062 | 1,37 | 0,1951 | 0,0097 |
| A02- | Unterpremstätten | Lieboch | 1,06 | 0,1894 | 0,0033 | 1,06 | 0,1894 | 0,0052 | 1,48 | 0,2652 | 0,0076 | 1,49 | 0,2652 | 0,0120 | 2,12 | 0,3030 | 0,0096 | 2,13 | 0,3030 | 0,0151 |
| A02- | Lieboch | Mooskirchen | 1,46 | 0,2612 | 0,0046 | 1,46 | 0,2612 | 0,0072 | 2,04 | 0,3656 | 0,0105 | 2,05 | 0,3656 | 0,0165 | 2,93 | 0,4179 | 0,0133 | 2,94 | 0,4179 | 0,0208 |
| A02- | Mooskirchen | Steinberg | 1,51 | 0,2703 | 0,0047 | 1,51 | 0,2703 | 0,0074 | 2,11 | 0,3784 | 0,0109 | 2,12 | 0,3784 | 0,0171 | 3,03 | 0,4324 | 0,0137 | 3,04 | 0,4324 | 0,0216 |
| A02- | Steinberg | Modriach | 3,76 | 0,6756 | 0,0118 | 3,77 | 0,6756 | 0,0186 | 5,28 | 0,9458 | 0,0272 | 5,30 | 0,9458 | 0,0427 | 7,58 | 1,0810 | 0,0343 | 7,60 | 1,0810 | 0,0539 |
| A022 | KN Graz Ost | Puchwerk | 0,16 | 0,0283 | 0,0005 | 0,16 | 0,0283 | 0,0008 | 0,22 | 0,0396 | 0,0011 | 0,22 | 0,0396 | 0,0018 | 0,32 | 0,0453 | 0,0014 | 0,32 | 0,0453 | 0,0023 |
| A022 | Puchwerk | Graz Raaba | 0,23 | 0,0405 | 0,0007 | 0,23 | 0,0405 | 0,0011 | 0,32 | 0,0567 | 0,0016 | 0,32 | 0,0567 | 0,0026 | 0,45 | 0,0648 | 0,0021 | 0,46 | 0,0648 | 0,0032 |
| A022 | Graz Raaba | Graz Sternäckerweg | 0,33 | 0,0588 | 0,0010 | 0,33 | 0,0588 | 0,0016 | 0,46 | 0,0824 | 0,0024 | 0,46 | 0,0824 | 0,0037 | 0,66 | 0,0941 | 0,0030 | 0,66 | 0,0941 | 0,0047 |
| A02- | Modriach | Packsattel | 1,73 | 0,3112 | 0,0054 | 1,74 | 0,3112 | 0,0086 | 2,43 | 0,4356 | 0,0125 | 2,44 | 0,4356 | 0,0197 | 3,49 | 0,4979 | 0,0158 | 3,50 | 0,4979 | 0,0248 |
| A02- | Packsattel | Bad St. Leonhard | 2,11 | 0,3784 | 0,0066 | 2,11 | 0,3784 | 0,0104 | 2,96 | 0,5297 | 0,0152 | 2,97 | 0,5297 | 0,0239 | 4,24 | 0,6054 | 0,0192 | 4,25 | 0,6054 | 0,0302 |
| A02- | Bad St. Leonhard | Wolfsberg Nord | 2,48 | 0,4446 | 0,0078 | 2,48 | 0,4446 | 0,0122 | 3,48 | 0,6225 | 0,0179 | 3,49 | 0,6225 | 0,0281 | 4,99 | 0,7114 | 0,0226 | 5,00 | 0,7114 | 0,0355 |
| A02- | Wolfsberg Nord | Wolfsberg Süd | 0,70 | 0,1264 | 0,0022 | 0,71 | 0,1264 | 0,0035 | 0,99 | 0,1770 | 0,0051 | 0,99 | 0,1770 | 0,0080 | 1,42 | 0,2022 | 0,0064 | 1,42 | 0,2022 | 0,0101 |
| A02- | Wolfsberg Süd | St. Andrä | 2,07 | 0,3714 | 0,0065 | 2,07 | 0,3714 | 0,0102 | 2,90 | 0,5200 | 0,0149 | 2,91 | 0,5200 | 0,0235 | 4,17 | 0,5942 | 0,0188 | 4,18 | 0,5942 | 0,0296 |
| A02- | St. Andrä | Griffen | 2,01 | 0,3610 | 0,0063 | 2,02 | 0,3610 | 0,0099 | 2,82 | 0,5054 | 0,0145 | 2,83 | 0,5054 | 0,0228 | 4,05 | 0,5776 | 0,0183 | 4,06 | 0,5776 | 0,0288 |
| A02- | Griffen | Völkermarkt Ost | 1,02 | 0,1824 | 0,0032 | 1,02 | 0,1824 | 0,0050 | 1,43 | 0,2553 | 0,0073 | 1,43 | 0,2553 | 0,0115 | 2,05 | 0,2918 | 0,0093 | 2,05 | 0,2918 | 0,0145 |
| A02- | Völkermarkt Ost | Völkermarkt West | 2,35 | 0,4208 | 0,0074 | 2,35 | 0,4208 | 0,0116 | 3,29 | 0,5892 | 0,0169 | 3,30 | 0,5892 | 0,0266 | 4,72 | 0,6733 | 0,0214 | 4,73 | 0,6733 | 0,0336 |
| A02- | Völkermarkt West | Grafenstein | 2,24 | 0,4028 | 0,0070 | 2,25 | 0,4028 | 0,0111 | 3,15 | 0,5640 | 0,0162 | 3,16 | 0,5640 | 0,0255 | 4,52 | 0,6445 | 0,0204 | 4,53 | 0,6445 | 0,0321 |
| A02- | Grafenstein | Klagenfurt Ost | 1,44 | 0,2584 | 0,0045 | 1,44 | 0,2584 | 0,0071 | 2,02 | 0,3618 | 0,0104 | 2,03 | 0,3618 | 0,0163 | 2,90 | 0,4134 | 0,0131 | 2,91 | 0,4134 | 0,0206 |
| A02- | Klagenfurt Ost | Klagenfurt Flughafen | 0,73 | 0,1307 | 0,0023 | 0,73 | 0,1307 | 0,0036 | 1,02 | 0,1830 | 0,0053 | 1,02 | 0,1830 | 0,0083 | 1,47 | 0,2092 | 0,0066 | 1,47 | 0,2092 | 0,0104 |
| A02- | Klagenfurt Flughafen | Klagenfurt Nord | 0,81 | 0,1448 | 0,0025 | 0,81 | 0,1448 | 0,0040 | 1,13 | 0,2027 | 0,0058 | 1,14 | 0,2027 | 0,0092 | 1,62 | 0,2317 | 0,0073 | 1,63 | 0,2317 | 0,0115 |
| A02- | Klagenfurt Nord | Klagenfurt West | 1,40 | 0,2504 | 0,0044 | 1,40 | 0,2504 | 0,0069 | 1,96 | 0,3505 | 0,0101 | 1,96 | 0,3505 | 0,0158 | 2,81 | 0,4006 | 0,0127 | 2,82 | 0,4006 | 0,0200 |
| A02- | Klagenfurt West | Kruppendorf West | 0,56 | 0,0998 | 0,0017 | 0,56 | 0,0998 | 0,0027 | 0,78 | 0,1397 | 0,0040 | 0,78 | 0,1397 | 0,0063 | 1,12 | 0,1597 | 0,0051 | 1,12 | 0,1597 | 0,0080 |
| A02- | Kruppendorf West | Pörschach Ost | 0,67 | 0,1202 | 0,0021 | 0,67 | 0,1202 | 0,0033 | 0,94 | 0,1683 | 0,0048 | 0,94 | 0,1683 | 0,0076 | 1,35 | 0,1923 | 0,0061 | 1,35 | 0,1923 | 0,0096 |
| A02- | Pörschach Ost | Pörschach West | 1,04 | 0,1872 | 0,0033 | 1,04 | 0,1872 | 0,0051 | 1,46 | 0,2620 | 0,0075 | 1,47 | 0,2620 | 0,0118 | 2,10 | 0,2995 | 0,0095 | 2,10 | 0,2995 | 0,0149 |
| A02- | Pörschach West | Velden Ost | 0,77 | 0,1387 | 0,0024 | 0,77 | 0,1387 | 0,0038 | 1,08 | 0,1942 | 0,0056 | 1,09 | 0,1942 | 0,0088 | 1,56 | 0,2219 | 0,0070 | 1,56 | 0,2219 | 0,0111 |
| A02- | Velden Ost | Velden West | 0,83 | 0,1493 | 0,0026 | 0,83 | 0,1493 | 0,0041 | 1,17 | 0,2090 | 0,0060 | 1,17 | 0,2090 | 0,0094 | 1,67 | 0,2389 | 0,0076 | 1,68 | 0,2389 | 0,0119 |
| A02- | Velden West | Wernberg | 1,38 | 0,2468 | 0,0043 | 1,38 | 0,2468 | 0,0068 | 1,93 | 0,3455 | 0,0099 | 1,93 | 0,3455 | 0,0156 | 2,77 | 0,3949 | 0,0125 | 2,78 | 0,3949 | 0,0197 |
| A02- | Wernberg | KN Villach | 0,73 | 0,1312 | 0,0023 | 0,73 | 0,1312 | 0,0036 | 1,03 | 0,1837 | 0,0053 | 1,03 | 0,1837 | 0,0083 | 1,47 | 0,2099 | 0,0067 | 1,48 | 0,2099 | 0,0105 |
| A02- | KN Villach | Villach Faaker See | 0,57 | 0,1020 | 0,0018 | 0,57 | 0,1020 | 0,0028 | 0,80 | 0,1428 | 0,0041 | 0,80 | 0,1428 | 0,0065 | 1,14 | 0,1632 | 0,0052 | 1,15 | 0,1632 | 0,0081 |
| A02- | Villach Faaker See | Villach Warmbad | 1,30 | 0,2330 | 0,0041 | 1,30 | 0,2330 | 0,0064 | 1,82 | 0,3262 | 0,0094 | 1,83 | 0,3262 | 0,0147 | 2,61 | 0,3728 | 0,0118 | 2,62 | 0,3728 | 0,0186 |
| A02- | Villach Warmbad | Hermagor | 2,35 | 0,4224 | 0,0074 | 2,36 | 0,4224 | 0,0116 | 3,30 | 0,5914 | 0,0170 | 3,31 | 0,5914 | 0,0267 | 4,74 | 0,6758 | 0,0214 | 4,75 | 0,6758 | 0,0337 |
| A02- | Hermagor | Arnoldstein | 0,56 | 0,1006 | 0,0018 | 0,56 | 0,1006 | 0,0028 | 0,79 | 0,1408 | 0,0040 | 0,79 | 0,1408 | 0,0064 | 1,13 | 0,1610 | 0,0051 | 1,13 | 0,1610 | 0,0080 |
| A02- | Arnoldstein | Staatsgrenze Arnoldstein | 0,86 | 0,1542 | 0,0027 | 0,86 | 0,1542 | 0,0042 | 1,21 | 0,2159 | 0,0062 | 1,21 | 0,2159 | 0,0098 | 1,73 | 0,2468 | 0,0078 | 1,73 | 0,2468 | 0,0123 |
| A03- | KN Guntramsdorf | Münchendorf/Achau | 0,22 | 0,0400 | 0,0007 | 0,22 | 0,0400 | 0,0011 | 0,31 | 0,0561 | 0,0016 | 0,31 | 0,0561 | 0,0025 | 0,45 | 0,0641 | 0,0020 | 0,45 | 0,0641 | 0,0032 |
| A03- | Münchendorf/Achau | Ebreichsdorf Nord | 0,94 | 0,1686 | 0,0029 | 0,94 | 0,1686 | 0,0046 | 1,32 | 0,2360 | 0,0068 | 1,32 | 0,2360 | 0,0107 | 1,89 | 0,2697 | 0,0086 | 1,90 | 0,2697 | 0,0134 |
| A03- | Ebreichsdorf Nord | Ebreichsdorf West | 0,77 | 0,1376 | 0,0024 | 0,77 | 0,1376 | 0,0038 | 1,08 | 0,1926 | 0,0055 | 1,08 | 0,1926 | 0,0087 | 1,54 | 0,2202 | 0,0070 | 1,55 | 0,2202 | 0,0110 |
| A03- | Ebreichsdorf West | Pottendorf | 1,01 | 0,1805 | 0,0032 | 1,01 | 0,1805 | 0,0050 | 1,41 | 0,2527 | 0,0073 | 1,42 | 0,2527 | 0,0114 | 2,02 | 0,2888 | 0,0092 | 2,03 | 0,2888 | 0,0144 |
| A03- | Pottendorf | Hornstein | 1,65 | 0,2964 | 0,0052 | 1,65 | 0,2964 | 0,0082 | 2,32 | 0,4150 | 0,0119 | 2,32 | 0,4150 | 0,0187 | 3,32 | 0,4742 | 0,0150 | 3,33 | 0,4742 | 0,0236 |
| A03- | Hornstein | Müllendorf | 1,08 | 0,1942 | 0,0034 | 1,08 | 0,1942 | 0,0053 | 1,52 | 0,2719 | 0,0078 | 1,52 | 0,2719 | 0,0123 | 2,18 | 0,3108 | 0,0099 | 2,18 | 0,3108 | 0,0155 |
| A03- | Müllendorf | KN Eisenstadt | 0,90 | 0,1624 | 0,0028 | 0,91 | 0,1624 | 0,0045 | 1,27 | 0,2273 | 0,0065 | 1,27 | 0,2273 | 0,0103 | 1,82 | 0,2598 | 0,0082 | 1,83 | 0,2598 | 0,0129 |
| A031 | KN Eisenstadt | Siegersdorf | 0,71 | 0,1280 | 0,0022 | 0,71 | 0,1280 | 0,0035 | 1,00 | 0,1792 | 0,0052 | 1,00 | 0,1792 | 0,0081 | 1,44 | 0,2048 | 0,0065 | 1,44 | 0,2048 | 0,0102 |
| A041 | Stadionbrücke | KN Wien Prater | 0,13 | 0,0235 | 0,0004 | 0,13 | 0,0235 | 0,0006 | 0,18 | 0,0329 | 0,0009 | 0,18 | 0,0329 | 0,0015 | 0,26 | 0,0376 | 0,0012 | 0,26 | 0,0376 | 0,0019 |
| A04- | KN Wien Prater | Alt-Simmering Wien 7. Haidequerstraße | 0,29 | 0,0512 | 0,0009 | 0,29 | 0,0512 | 0,0014 | 0,40 | 0,0717 | 0,0021 | 0,40 | 0,0717 | 0,0032 | 0,57 | 0,0820 | 0,0026 | 0,58 | 0,0820 | 0,0041 |
| A04- | Alt-Simmering | Wien 7. Haidequerstraße | 0,22 | 0,0387 | 0,0007 | 0,22 | 0,0387 | 0,0011 | 0,30 | 0,0542 | 0,0016 | 0,30 | 0,0542 | 0,0024 | 0,43 | 0,0619 | 0,0020 | 0,44 | 0,0619 | 0,0031 |
| A04- | Wien 7. Haidequerstraße | Wien Simmeringer Haide | 0,40 | 0,0723 | 0,0013 | 0,40 | 0,0723 | 0,0020 | 0,57 | 0,1012 | 0,0029 | 0,57 | 0,1012 | 0,0046 | 0,81 | 0,1156 | 0,0037 | 0,81 | 0,1156 | 0,0058 |
| A04- | Wien Simmeringer Haide | KN Schwechat | 0,81 | 0,1456 | 0,0025 | 0,81 | 0,1456 | 0,0040 | 1,14 | 0,2038 | 0,0059 | 1,14 | 0,2038 | 0,0092 | 1,63 | 0,2330 | 0,0074 | 1,64 | 0,2330 | 0,0116 |
| A04- | KN Schwechat | Flughafen Wien Schwechat | 1,17 | 0,2103 | 0,0037 | 1,17 | 0,2103 | 0,0058 | 1,64 | 0,2944 | 0,0085 | 1,65 | 0,2944 | 0,0133 | 2,36 | 0,3365 | 0,0107 | 2,37 | 0,3365 | 0,0168 |
| A04- | Flughafen Wien Schwechat | Fischamend | 1,31 | 0,2355 | 0,0041 | 1,31 | 0,2355 | 0,0065 | 1,84 | 0,3297 | 0,0095 | 1,85 | 0,3297 | 0,0149 | 2,64 | 0,3768 | 0,0120 | 2,65 | 0,3768 | 0,0188 |
| A04- | Fischamend | Bruck/Leitha West | 2,88 | 0,5164 | 0,0090 | 2,88 | 0,5164 | 0,0142 | 4,04 | 0,7230 | 0,0208 | 4,05 | 0,7230 | 0,0327 | 5,79 | 0,8263 | 0,0262 | 5,81 | 0,8263 | 0,0412 |
| A04- | Bruck/Leitha West | Bruck/Leitha Ost | 0,96 | 0,1715 | 0,0030 | 0,96 | 0,1715 | 0,0047 | 1,34 | 0,2401 | 0,0 | | | | | | | | | |

| | | | | | | | | | | | | | | | | | | | | |
|------|----------------------------------|----------------------------------|-------|--------|--------|-------|--------|--------|-------|--------|--------|-------|--------|--------|-------|--------|--------|-------|--------|--------|
| A05- | Großkrut | Poysdorf Nord | 1,53 | 0,2741 | 0,0048 | 1,53 | 0,2741 | 0,0075 | 2,14 | 0,3838 | 0,0110 | 2,15 | 0,3838 | 0,0173 | 3,07 | 0,4386 | 0,0139 | 3,08 | 0,4386 | 0,0219 |
| A06- | KN Bruckneudorf | Potzneusiedl | 1,94 | 0,3472 | 0,0061 | 1,94 | 0,3472 | 0,0095 | 2,71 | 0,4861 | 0,0140 | 2,72 | 0,4861 | 0,0220 | 3,89 | 0,5556 | 0,0176 | 3,90 | 0,5556 | 0,0277 |
| A06- | Potzneusiedl | Gattendorf | 0,84 | 0,1507 | 0,0026 | 0,84 | 0,1507 | 0,0041 | 1,18 | 0,2110 | 0,0061 | 1,18 | 0,2110 | 0,0095 | 1,69 | 0,2412 | 0,0076 | 1,69 | 0,2412 | 0,0120 |
| A06- | Gattendorf | Kittsee | 1,40 | 0,2521 | 0,0044 | 1,41 | 0,2521 | 0,0069 | 1,97 | 0,3529 | 0,0101 | 1,98 | 0,3529 | 0,0159 | 2,83 | 0,4033 | 0,0128 | 2,83 | 0,4033 | 0,0201 |
| A06- | Kittsee | Staatsgrenze Kittsee | 0,71 | 0,1280 | 0,0022 | 0,71 | 0,1280 | 0,0035 | 1,00 | 0,1793 | 0,0052 | 1,00 | 0,1793 | 0,0081 | 1,44 | 0,2049 | 0,0065 | 1,44 | 0,2049 | 0,0102 |
| A07- | KN Linz | Linz Franzosenhausweg | 0,50 | 0,0903 | 0,0016 | 0,50 | 0,0903 | 0,0025 | 0,71 | 0,1264 | 0,0036 | 0,71 | 0,1264 | 0,0057 | 1,01 | 0,1445 | 0,0046 | 1,02 | 0,1445 | 0,0072 |
| A07- | Linz Franzosenhausweg | Linz Salzburger Straße Neue Welt | 0,44 | 0,0788 | 0,0014 | 0,44 | 0,0788 | 0,0022 | 0,62 | 0,1104 | 0,0032 | 0,62 | 0,1104 | 0,0050 | 0,88 | 0,1261 | 0,0040 | 0,89 | 0,1261 | 0,0063 |
| A07- | Linz Salzburger Straße Neue Welt | Muldenstraße Bindermichl | 0,30 | 0,0547 | 0,0010 | 0,31 | 0,0547 | 0,0015 | 0,43 | 0,0766 | 0,0022 | 0,43 | 0,0766 | 0,0035 | 0,61 | 0,0876 | 0,0028 | 0,62 | 0,0876 | 0,0044 |
| A07- | Muldenstraße Bindermichl | Leonding Linz Zentrum | 0,15 | 0,0266 | 0,0005 | 0,15 | 0,0266 | 0,0007 | 0,21 | 0,0372 | 0,0011 | 0,21 | 0,0372 | 0,0017 | 0,30 | 0,0425 | 0,0013 | 0,30 | 0,0425 | 0,0021 |
| A07- | Leonding Linz Zentrum | Linz Wiener Straße | 0,21 | 0,0374 | 0,0007 | 0,21 | 0,0374 | 0,0010 | 0,29 | 0,0523 | 0,0015 | 0,29 | 0,0523 | 0,0024 | 0,42 | 0,0598 | 0,0019 | 0,42 | 0,0598 | 0,0030 |
| A07- | Linz Wiener Straße | Linz VOEST | 0,19 | 0,0347 | 0,0006 | 0,19 | 0,0347 | 0,0010 | 0,27 | 0,0486 | 0,0014 | 0,27 | 0,0486 | 0,0022 | 0,39 | 0,0556 | 0,0018 | 0,39 | 0,0556 | 0,0028 |
| A07- | Linz VOEST | Linz Industriezeile | 0,15 | 0,0272 | 0,0005 | 0,15 | 0,0272 | 0,0007 | 0,21 | 0,0381 | 0,0011 | 0,21 | 0,0381 | 0,0017 | 0,31 | 0,0436 | 0,0014 | 0,31 | 0,0436 | 0,0022 |
| A07- | Linz Industriezeile | Linz Prinz Eugenstraße | 0,24 | 0,0432 | 0,0008 | 0,24 | 0,0432 | 0,0012 | 0,34 | 0,0605 | 0,0017 | 0,34 | 0,0605 | 0,0027 | 0,49 | 0,0692 | 0,0022 | 0,49 | 0,0692 | 0,0034 |
| A07- | Linz Prinz Eugenstraße | Linz Hafenstraße | 0,45 | 0,0809 | 0,0014 | 0,45 | 0,0809 | 0,0022 | 0,63 | 0,1133 | 0,0033 | 0,63 | 0,1133 | 0,0051 | 0,91 | 0,1295 | 0,0041 | 0,91 | 0,1295 | 0,0065 |
| A07- | Linz Hafenstraße | Linz Urfahr | 0,18 | 0,0318 | 0,0006 | 0,18 | 0,0318 | 0,0009 | 0,25 | 0,0445 | 0,0013 | 0,25 | 0,0445 | 0,0020 | 0,36 | 0,0509 | 0,0016 | 0,36 | 0,0509 | 0,0025 |
| A07- | Linz Urfahr | Linz Dornach | 0,43 | 0,0770 | 0,0013 | 0,43 | 0,0770 | 0,0021 | 0,60 | 0,1078 | 0,0031 | 0,60 | 0,1078 | 0,0049 | 0,86 | 0,1232 | 0,0039 | 0,87 | 0,1232 | 0,0061 |
| A07- | Linz Dornach | Treffling | 0,94 | 0,1694 | 0,0030 | 0,95 | 0,1694 | 0,0047 | 1,32 | 0,2371 | 0,0068 | 1,33 | 0,2371 | 0,0107 | 1,90 | 0,2710 | 0,0086 | 1,90 | 0,2710 | 0,0135 |
| A07- | Treffling | Gallneukirchen | 0,71 | 0,1276 | 0,0022 | 0,71 | 0,1276 | 0,0035 | 1,00 | 0,1786 | 0,0051 | 1,00 | 0,1786 | 0,0081 | 1,43 | 0,2042 | 0,0065 | 1,44 | 0,2042 | 0,0102 |
| A07- | Gallneukirchen | Engerwitzdorf | 0,63 | 0,1137 | 0,0020 | 0,63 | 0,1137 | 0,0031 | 0,89 | 0,1592 | 0,0046 | 0,89 | 0,1592 | 0,0072 | 1,28 | 0,1819 | 0,0058 | 1,28 | 0,1819 | 0,0091 |
| A07- | Engerwitzdorf | Unterweikersdorf | 0,81 | 0,1458 | 0,0026 | 0,81 | 0,1458 | 0,0040 | 1,14 | 0,2041 | 0,0059 | 1,14 | 0,2041 | 0,0092 | 1,63 | 0,2332 | 0,0074 | 1,64 | 0,2332 | 0,0116 |
| A08- | KN Voralpenkreuz | Wels West | 2,49 | 0,4471 | 0,0078 | 2,50 | 0,4471 | 0,0123 | 3,50 | 0,6260 | 0,0180 | 3,51 | 0,6260 | 0,0283 | 5,02 | 0,7154 | 0,0227 | 5,03 | 0,7154 | 0,0357 |
| A08- | Wels West | KN Wels | 0,88 | 0,1577 | 0,0028 | 0,88 | 0,1577 | 0,0043 | 1,23 | 0,2208 | 0,0063 | 1,24 | 0,2208 | 0,0100 | 1,77 | 0,2523 | 0,0080 | 1,77 | 0,2523 | 0,0126 |
| A08- | KN Wels | Pichl/Bad Schallerbach | 0,97 | 0,1735 | 0,0030 | 0,97 | 0,1735 | 0,0048 | 1,36 | 0,2429 | 0,0070 | 1,36 | 0,2429 | 0,0110 | 1,95 | 0,2776 | 0,0088 | 1,95 | 0,2776 | 0,0138 |
| A08- | Pichl/Bad Schallerbach | Meggenhofen Gallsbach | 2,44 | 0,4384 | 0,0077 | 2,45 | 0,4384 | 0,0121 | 3,43 | 0,6138 | 0,0176 | 3,44 | 0,6138 | 0,0277 | 4,92 | 0,7015 | 0,0223 | 4,93 | 0,7015 | 0,0350 |
| A08- | Meggenhofen Gallsbach | Haag am Hausruck | 2,66 | 0,4778 | 0,0084 | 2,67 | 0,4778 | 0,0131 | 3,74 | 0,6690 | 0,0192 | 3,75 | 0,6690 | 0,0302 | 5,36 | 0,7645 | 0,0243 | 5,37 | 0,7645 | 0,0381 |
| A08- | Haag am Hausruck | Ried im Innkreis | 2,43 | 0,4361 | 0,0076 | 2,43 | 0,4361 | 0,0120 | 3,41 | 0,6105 | 0,0176 | 3,42 | 0,6105 | 0,0276 | 4,89 | 0,6977 | 0,0221 | 4,90 | 0,6977 | 0,0348 |
| A08- | Ried im Innkreis | Ort im Innkreis | 2,61 | 0,4680 | 0,0082 | 2,61 | 0,4680 | 0,0129 | 3,66 | 0,6553 | 0,0188 | 3,67 | 0,6553 | 0,0296 | 5,25 | 0,7489 | 0,0238 | 5,26 | 0,7489 | 0,0373 |
| A08- | Ort im Innkreis | Schärding Suben | 1,97 | 0,3533 | 0,0062 | 1,97 | 0,3533 | 0,0097 | 2,76 | 0,4946 | 0,0142 | 2,77 | 0,4946 | 0,0223 | 3,96 | 0,5652 | 0,0179 | 3,97 | 0,5652 | 0,0282 |
| A08- | Schärding Suben | Staatsgrenze Suben | 0,50 | 0,0893 | 0,0016 | 0,50 | 0,0893 | 0,0025 | 0,70 | 0,1250 | 0,0036 | 0,70 | 0,1250 | 0,0056 | 1,00 | 0,1428 | 0,0045 | 1,00 | 0,1428 | 0,0071 |
| A09- | KN Voralpenkreuz | Ried im Traunkreis | 1,23 | 0,2200 | 0,0039 | 1,23 | 0,2200 | 0,0061 | 1,72 | 0,3081 | 0,0089 | 1,73 | 0,3081 | 0,0139 | 2,47 | 0,3521 | 0,0112 | 2,47 | 0,3521 | 0,0175 |
| A09- | Ried im Traunkreis | Inzersdorf Kirchdorf | 2,30 | 0,4128 | 0,0072 | 2,30 | 0,4128 | 0,0114 | 3,23 | 0,5779 | 0,0166 | 3,24 | 0,5779 | 0,0261 | 4,63 | 0,6604 | 0,0209 | 4,64 | 0,6604 | 0,0329 |
| A09- | Inzersdorf Kirchdorf | Klaus | 2,80 | 0,5028 | 0,0088 | 2,81 | 0,5028 | 0,0138 | 3,93 | 0,7039 | 0,0202 | 3,94 | 0,7039 | 0,0318 | 5,64 | 0,8045 | 0,0255 | 5,65 | 0,8045 | 0,0401 |
| A09- | Klaus | St. Pankratz | 1,78 | 0,3196 | 0,0056 | 1,78 | 0,3196 | 0,0088 | 2,50 | 0,4474 | 0,0129 | 2,51 | 0,4474 | 0,0202 | 3,58 | 0,5114 | 0,0162 | 3,59 | 0,5114 | 0,0255 |
| A09- | St. Pankratz | Roßleiten Windischgarsten | 2,48 | 0,4459 | 0,0078 | 2,49 | 0,4459 | 0,0123 | 3,49 | 0,6243 | 0,0179 | 3,50 | 0,6243 | 0,0282 | 5,00 | 0,7135 | 0,0226 | 5,01 | 0,7135 | 0,0356 |
| A09- | Roßleiten Windischgarsten | Gleinkerau | 1,17 | 0,2096 | 0,0037 | 1,17 | 0,2096 | 0,0058 | 1,64 | 0,2934 | 0,0084 | 1,64 | 0,2934 | 0,0133 | 2,35 | 0,3354 | 0,0106 | 2,36 | 0,3354 | 0,0167 |
| A09- | Gleinkerau | Spital am Pyhrn | 0,88 | 0,1580 | 0,0028 | 0,88 | 0,1580 | 0,0043 | 1,24 | 0,2212 | 0,0064 | 1,24 | 0,2212 | 0,0100 | 1,77 | 0,2528 | 0,0080 | 1,78 | 0,2528 | 0,0126 |
| A09- | Spital am Pyhrn | Ardning / Admont | 4,53 | 0,4022 | 0,0070 | 4,54 | 0,4022 | 0,0111 | 6,35 | 0,5631 | 0,0162 | 6,36 | 0,5631 | 0,0254 | 9,33 | 0,6436 | 0,0204 | 9,34 | 0,6436 | 0,0321 |
| A09- | Ardning / Admont | Liezen | 0,51 | 0,0917 | 0,0016 | 0,51 | 0,0917 | 0,0025 | 0,72 | 0,1284 | 0,0037 | 0,72 | 0,1284 | 0,0058 | 1,03 | 0,1467 | 0,0047 | 1,03 | 0,1467 | 0,0073 |
| A09- | Liezen | Rottenmann | 1,07 | 0,1916 | 0,0034 | 1,07 | 0,1916 | 0,0053 | 1,50 | 0,2682 | 0,0077 | 1,50 | 0,2682 | 0,0121 | 2,15 | 0,3065 | 0,0097 | 2,15 | 0,3065 | 0,0153 |
| A09- | Rottenmann | Trieben | 2,66 | 0,4776 | 0,0084 | 2,67 | 0,4776 | 0,0131 | 3,73 | 0,6686 | 0,0192 | 3,74 | 0,6686 | 0,0302 | 5,36 | 0,7641 | 0,0242 | 5,37 | 0,7641 | 0,0381 |
| A09- | Trieben | Treglwang | 2,16 | 0,3883 | 0,0068 | 2,17 | 0,3883 | 0,0107 | 3,04 | 0,5436 | 0,0156 | 3,04 | 0,5436 | 0,0246 | 4,36 | 0,6212 | 0,0197 | 4,37 | 0,6212 | 0,0310 |
| A09- | Treglwang | Kalwang | 2,91 | 0,5218 | 0,0091 | 2,91 | 0,5218 | 0,0143 | 4,08 | 0,7305 | 0,0210 | 4,09 | 0,7305 | 0,0330 | 5,85 | 0,8349 | 0,0265 | 5,87 | 0,8349 | 0,0416 |
| A09- | Kalwang | Mautern | 1,35 | 0,2430 | 0,0043 | 1,36 | 0,2430 | 0,0067 | 1,90 | 0,3401 | 0,0098 | 1,90 | 0,3401 | 0,0154 | 2,73 | 0,3887 | 0,0123 | 2,73 | 0,3887 | 0,0194 |
| A09- | Mautern | Kammern | 1,52 | 0,2733 | 0,0048 | 1,53 | 0,2733 | 0,0075 | 2,14 | 0,3826 | 0,0110 | 2,14 | 0,3826 | 0,0173 | 3,07 | 0,4373 | 0,0139 | 3,07 | 0,4373 | 0,0218 |
| A09- | Kammern | Traboch | 1,59 | 0,2858 | 0,0050 | 1,60 | 0,2858 | 0,0079 | 2,23 | 0,4001 | 0,0115 | 2,24 | 0,4001 | 0,0181 | 3,21 | 0,4572 | 0,0145 | 3,21 | 0,4572 | 0,0228 |
| A09- | Traboch | Terminal St. Michael | 0,31 | 0,0561 | 0,0010 | 0,31 | 0,0561 | 0,0015 | 0,44 | 0,0786 | 0,0023 | 0,44 | 0,0786 | 0,0035 | 0,63 | 0,0898 | 0,0028 | 0,63 | 0,0898 | 0,0045 |
| A09- | Terminal St. Michael | KN St. Michael | 0,59 | 0,1052 | 0,0018 | 0,59 | 0,1052 | 0,0029 | 0,82 | 0,1473 | 0,0042 | 0,82 | 0,1473 | 0,0067 | 1,18 | 0,1683 | 0,0053 | 1,18 | 0,1683 | 0,0084 |
| A09- | KN St. Michael | Übelbach | 11,04 | 0,9797 | 0,0171 | 11,05 | 0,9797 | 0,0289 | 15,48 | 1,3716 | 0,0394 | 15,50 | 1,3716 | 0,0620 | 22,72 | 1,5676 | 0,0497 | 22,74 | 1,5676 | 0,0781 |
| A09- | Übelbach | KN Peggau Deutschfeistritz | 1,81 | 0,3240 | 0,0057 | 1,81 | 0,3240 | 0,0089 | 2,53 | 0,4537 | 0,0130 | 2,54 | 0,4537 | 0,0205 | 3,63 | 0,5185 | 0,0164 | 3,64 | 0,5185 | 0,0258 |
| A09- | KN Peggau Deutschfeistritz | Gratkorn Nord | 0,86 | 0,1535 | 0,0027 | 0,86 | 0,1535 | 0,0042 | 1,20 | 0,2149 | 0,0062 | 1,20 | 0,2149 | 0,0097 | 1,72 | 0,2456 | 0,0078 | 1,73 | 0,2456 | 0,0122 |
| A09- | Gratkorn Nord | Gratkorn Süd | 0,94 | 0,1686 | 0,0030 | 0,94 | 0,1686 | 0,0046 | 1,32 | 0,2360 | 0,0068 | 1,32 | 0,2360 | 0,0107 | 1,89 | 0,2698 | 0,0086 | 1,90 | 0,2698 | |

| | | | | | | | | | | | | | | | | | | | | |
|------|--|---|-------|--------|--------|-------|--------|--------|-------|--------|--------|-------|--------|--------|-------|--------|--------|-------|--------|--------|
| A10- | Hallein | Kuchl | 1,30 | 0,2342 | 0,0041 | 1,31 | 0,2342 | 0,0064 | 1,83 | 0,3278 | 0,0094 | 1,84 | 0,3278 | 0,0148 | 2,63 | 0,3747 | 0,0119 | 2,63 | 0,3747 | 0,0187 |
| A10- | Kuchl | Golling / Abtenau | 1,31 | 0,2354 | 0,0041 | 1,31 | 0,2354 | 0,0065 | 1,84 | 0,3296 | 0,0095 | 1,85 | 0,3296 | 0,0149 | 2,64 | 0,3766 | 0,0119 | 2,65 | 0,3766 | 0,0188 |
| A10- | Golling / Abtenau | Paß Lueg | 1,37 | 0,2456 | 0,0043 | 1,37 | 0,2456 | 0,0068 | 1,92 | 0,3439 | 0,0099 | 1,93 | 0,3439 | 0,0155 | 2,76 | 0,3930 | 0,0125 | 2,76 | 0,3930 | 0,0196 |
| A10- | Paß Lueg | Werfen | 1,95 | 0,3499 | 0,0061 | 1,95 | 0,3499 | 0,0096 | 2,94 | 0,4898 | 0,0141 | 2,74 | 0,4898 | 0,0221 | 3,92 | 0,5598 | 0,0178 | 3,93 | 0,5598 | 0,0279 |
| A10- | Werfen | Pfarrwerfen / Werfen | 0,25 | 0,0456 | 0,0008 | 0,25 | 0,0456 | 0,0013 | 0,36 | 0,0638 | 0,0018 | 0,36 | 0,0638 | 0,0029 | 0,51 | 0,0730 | 0,0023 | 0,51 | 0,0730 | 0,0036 |
| A10- | Pfarrwerfen / Werfen | KN Pongau | 0,55 | 0,0990 | 0,0017 | 0,55 | 0,0990 | 0,0027 | 0,77 | 0,1385 | 0,0040 | 0,78 | 0,1385 | 0,0063 | 1,11 | 0,1583 | 0,0050 | 1,11 | 0,1583 | 0,0079 |
| A101 | KN Pongau | Bischofshofen Mühlbach a. Hochkönig | 0,82 | 0,1472 | 0,0026 | 0,82 | 0,1472 | 0,0040 | 1,15 | 0,2061 | 0,0059 | 1,15 | 0,2061 | 0,0093 | 1,65 | 0,2355 | 0,0075 | 1,66 | 0,2355 | 0,0117 |
| A10- | KN Pongau | Lammertal Hütttau | 2,24 | 0,4025 | 0,0070 | 2,25 | 0,4025 | 0,0111 | 3,15 | 0,5635 | 0,0162 | 3,16 | 0,5635 | 0,0255 | 4,51 | 0,6440 | 0,0204 | 4,53 | 0,6440 | 0,0321 |
| A10- | Lammertal Hütttau | F. Verbindung GH Eben | 0,58 | 0,1036 | 0,0018 | 0,58 | 0,1036 | 0,0028 | 0,81 | 0,1450 | 0,0042 | 0,81 | 0,1450 | 0,0066 | 1,16 | 0,1658 | 0,0053 | 1,17 | 0,1658 | 0,0083 |
| A10- | F. Verbindung GH Eben | Eben | 0,27 | 0,0480 | 0,0008 | 0,27 | 0,0480 | 0,0013 | 0,38 | 0,0672 | 0,0019 | 0,38 | 0,0672 | 0,0030 | 0,54 | 0,0768 | 0,0024 | 0,54 | 0,0768 | 0,0038 |
| A10- | Eben | Radstadt Altenmarkt Graz | 0,59 | 0,1066 | 0,0019 | 0,60 | 0,1066 | 0,0029 | 0,83 | 0,1492 | 0,0043 | 0,84 | 0,1492 | 0,0067 | 1,20 | 0,1706 | 0,0054 | 1,20 | 0,1706 | 0,0085 |
| A10- | Radstadt Altenmarkt Graz | Flachau | 0,83 | 0,1491 | 0,0026 | 0,83 | 0,1491 | 0,0041 | 1,17 | 0,2087 | 0,0060 | 1,17 | 0,2087 | 0,0094 | 1,67 | 0,2385 | 0,0076 | 1,68 | 0,2385 | 0,0119 |
| A10- | Flachau | Flachauwinkel | 3,05 | 0,2908 | 0,0051 | 3,05 | 0,2908 | 0,0080 | 4,27 | 0,4071 | 0,0117 | 4,28 | 0,4071 | 0,0184 | 6,26 | 0,4653 | 0,0148 | 6,27 | 0,4653 | 0,0232 |
| A10- | Flachauwinkel | Zederhaus | 7,69 | 0,7328 | 0,0128 | 7,69 | 0,7328 | 0,0202 | 10,77 | 1,0260 | 0,0295 | 10,79 | 1,0260 | 0,0464 | 15,78 | 1,1725 | 0,0372 | 15,80 | 1,1725 | 0,0584 |
| A10- | Zederhaus | St. Michael/Lungau | 5,07 | 0,4835 | 0,0085 | 5,08 | 0,4835 | 0,0133 | 7,11 | 0,6769 | 0,0195 | 7,12 | 0,6769 | 0,0306 | 10,41 | 0,7736 | 0,0245 | 10,43 | 0,7736 | 0,0386 |
| A10- | St. Michael/Lungau | Rennweg Katschberg | 3,72 | 0,3545 | 0,0062 | 3,72 | 0,3545 | 0,0097 | 5,21 | 0,4963 | 0,0143 | 5,22 | 0,4963 | 0,0224 | 7,63 | 0,5672 | 0,0180 | 7,65 | 0,5672 | 0,0283 |
| A102 | Seeboden | KN Spittal Millstätter See | 0,43 | 0,0776 | 0,0014 | 0,43 | 0,0776 | 0,0021 | 0,61 | 0,1086 | 0,0031 | 0,61 | 0,1086 | 0,0049 | 0,87 | 0,1242 | 0,0039 | 0,87 | 0,1242 | 0,0062 |
| A102 | KN Spittal Millstätter See | Lendorf | 0,93 | 0,1674 | 0,0029 | 0,93 | 0,1674 | 0,0046 | 1,31 | 0,2344 | 0,0067 | 1,31 | 0,2344 | 0,0106 | 1,88 | 0,2678 | 0,0085 | 1,88 | 0,2678 | 0,0134 |
| A10- | Rennweg Katschberg | Gmünd Maltatal | 3,77 | 0,6774 | 0,0119 | 3,78 | 0,6774 | 0,0186 | 5,30 | 0,9483 | 0,0273 | 5,31 | 0,9483 | 0,0428 | 7,60 | 1,0838 | 0,0344 | 7,62 | 1,0838 | 0,0540 |
| A10- | Gmünd Maltatal | KN Spittal Millstätter See | 2,15 | 0,3855 | 0,0067 | 2,15 | 0,3855 | 0,0106 | 3,01 | 0,5397 | 0,0155 | 3,02 | 0,5397 | 0,0244 | 4,32 | 0,6168 | 0,0196 | 4,34 | 0,6168 | 0,0307 |
| A10- | KN Spittal Millstätter See | Spittal Ost | 1,63 | 0,2920 | 0,0051 | 1,63 | 0,2920 | 0,0080 | 2,28 | 0,4088 | 0,0118 | 2,29 | 0,4088 | 0,0185 | 3,28 | 0,4672 | 0,0148 | 3,28 | 0,4672 | 0,0233 |
| A10- | Spittal Ost | Paternion Feistritz | 2,81 | 0,5043 | 0,0088 | 2,82 | 0,5043 | 0,0139 | 3,94 | 0,7060 | 0,0203 | 3,95 | 0,7060 | 0,0319 | 5,66 | 0,8068 | 0,0256 | 5,67 | 0,8068 | 0,0402 |
| A10- | Paternion Feistritz | Villach West | 3,03 | 0,5435 | 0,0095 | 3,03 | 0,5435 | 0,0149 | 4,25 | 0,7609 | 0,0219 | 4,26 | 0,7609 | 0,0344 | 6,10 | 0,8696 | 0,0276 | 6,11 | 0,8696 | 0,0433 |
| A10- | Villach West | Villach Ossiacher See | 1,31 | 0,2350 | 0,0041 | 1,31 | 0,2350 | 0,0065 | 1,84 | 0,3289 | 0,0095 | 1,84 | 0,3289 | 0,0149 | 2,64 | 0,3759 | 0,0119 | 2,64 | 0,3759 | 0,0187 |
| A10- | Villach Ossiacher See | KN Villach | 1,02 | 0,1836 | 0,0032 | 1,02 | 0,1836 | 0,0050 | 1,44 | 0,2570 | 0,0074 | 1,44 | 0,2570 | 0,0116 | 2,06 | 0,2938 | 0,0093 | 2,06 | 0,2938 | 0,0146 |
| A11- | KN Villach | St. Niklas Faakersee | 0,73 | 0,1314 | 0,0023 | 0,73 | 0,1314 | 0,0036 | 1,03 | 0,1840 | 0,0053 | 1,03 | 0,1840 | 0,0083 | 1,47 | 0,2102 | 0,0067 | 1,48 | 0,2102 | 0,0105 |
| A11- | St. Niklas Faakersee | St. Jakob/Rosental | 1,84 | 0,3300 | 0,0058 | 1,84 | 0,3300 | 0,0091 | 2,58 | 0,4621 | 0,0133 | 2,59 | 0,4621 | 0,0209 | 3,70 | 0,5281 | 0,0167 | 3,71 | 0,5281 | 0,0263 |
| A11- | St. Jakob/Rosental | Staatsgrenze Karawankentunnel | 16,10 | 0,3883 | 0,0068 | 16,11 | 0,3883 | 0,0107 | 22,55 | 0,5436 | 0,0156 | 22,56 | 0,5436 | 0,0246 | 33,63 | 0,6212 | 0,0197 | 33,64 | 0,6212 | 0,0310 |
| A12- | Staatsgrenze Kufstein | Kufstein Nord | 0,36 | 0,0000 | 0,0000 | 0,36 | 0,0000 | 0,0000 | 0,51 | 0,0000 | 0,0000 | 0,51 | 0,0000 | 0,0000 | 0,76 | 0,0000 | 0,0000 | 0,76 | 0,0000 | 0,0000 |
| A12- | Kufstein Nord | Kufstein Süd | 0,93 | 0,0000 | 0,0000 | 0,93 | 0,0000 | 0,0000 | 1,31 | 0,0000 | 0,0000 | 1,31 | 0,0000 | 0,0000 | 1,96 | 0,0000 | 0,0000 | 1,96 | 0,0000 | 0,0000 |
| A12- | Kufstein Süd | Kirchbichl Langkampfen | 1,27 | 0,0000 | 0,0000 | 1,27 | 0,0000 | 0,0000 | 1,78 | 0,0000 | 0,0000 | 1,78 | 0,0000 | 0,0000 | 2,68 | 0,0000 | 0,0000 | 2,68 | 0,0000 | 0,0000 |
| A12- | Kirchbichl Langkampfen | Wörgl Ost St.Johann i. T. Brixental | 1,25 | 0,0000 | 0,0000 | 1,25 | 0,0000 | 0,0000 | 1,75 | 0,0000 | 0,0000 | 1,75 | 0,0000 | 0,0000 | 2,62 | 0,0000 | 0,0000 | 2,62 | 0,0000 | 0,0000 |
| A12- | Wörgl Ost St.Johann i. T. Brixental | Wörgl West | 0,66 | 0,0000 | 0,0000 | 0,66 | 0,0000 | 0,0000 | 0,92 | 0,0000 | 0,0000 | 0,92 | 0,0000 | 0,0000 | 1,38 | 0,0000 | 0,0000 | 1,38 | 0,0000 | 0,0000 |
| A12- | Wörgl West | Kramsach Rattenberg Brixlegg | 2,80 | 0,0000 | 0,0000 | 2,80 | 0,0000 | 0,0000 | 3,92 | 0,0000 | 0,0000 | 3,92 | 0,0000 | 0,0000 | 5,88 | 0,0000 | 0,0000 | 5,88 | 0,0000 | 0,0000 |
| A12- | Kramsach Rattenberg Brixlegg | Wiesing Achensee Zillertal | 1,72 | 0,0000 | 0,0000 | 1,72 | 0,0000 | 0,0000 | 2,40 | 0,0000 | 0,0000 | 2,40 | 0,0000 | 0,0000 | 3,61 | 0,0000 | 0,0000 | 3,61 | 0,0000 | 0,0000 |
| A12- | Wiesing Achensee Zillertal | Jenbach | 0,68 | 0,0000 | 0,0000 | 0,68 | 0,0000 | 0,0000 | 0,95 | 0,0000 | 0,0000 | 0,95 | 0,0000 | 0,0000 | 1,43 | 0,0000 | 0,0000 | 1,43 | 0,0000 | 0,0000 |
| A12- | Jenbach | Schwaz | 1,50 | 0,0000 | 0,0000 | 1,50 | 0,0000 | 0,0000 | 2,10 | 0,0000 | 0,0000 | 2,10 | 0,0000 | 0,0000 | 3,15 | 0,0000 | 0,0000 | 3,15 | 0,0000 | 0,0000 |
| A12- | Schwaz | Vomp | 0,86 | 0,0000 | 0,0000 | 0,86 | 0,0000 | 0,0000 | 1,20 | 0,0000 | 0,0000 | 1,20 | 0,0000 | 0,0000 | 1,80 | 0,0000 | 0,0000 | 1,80 | 0,0000 | 0,0000 |
| A12- | Vomp | Wattens | 1,77 | 0,0000 | 0,0000 | 1,77 | 0,0000 | 0,0000 | 2,47 | 0,0000 | 0,0000 | 2,47 | 0,0000 | 0,0000 | 3,71 | 0,0000 | 0,0000 | 3,71 | 0,0000 | 0,0000 |
| A12- | Wattens | Hall/Tirol Mitte | 1,57 | 0,0000 | 0,0000 | 1,57 | 0,0000 | 0,0000 | 2,19 | 0,0000 | 0,0000 | 2,19 | 0,0000 | 0,0000 | 3,29 | 0,0000 | 0,0000 | 3,29 | 0,0000 | 0,0000 |
| A12- | Hall/Tirol Mitte | Hall/Tirol West | 0,63 | 0,0000 | 0,0000 | 0,63 | 0,0000 | 0,0000 | 0,88 | 0,0000 | 0,0000 | 0,88 | 0,0000 | 0,0000 | 1,32 | 0,0000 | 0,0000 | 1,32 | 0,0000 | 0,0000 |
| A12- | Hall/Tirol West | A12 Innsbruck Ost | 0,70 | 0,0000 | 0,0000 | 0,70 | 0,0000 | 0,0000 | 0,97 | 0,0000 | 0,0000 | 0,97 | 0,0000 | 0,0000 | 1,46 | 0,0000 | 0,0000 | 1,46 | 0,0000 | 0,0000 |
| A12- | A12 Innsbruck Ost | Innsbruck Mitte | 0,48 | 0,0226 | 0,0004 | 0,48 | 0,0226 | 0,0006 | 0,67 | 0,0317 | 0,0009 | 0,67 | 0,0317 | 0,0014 | 0,99 | 0,0362 | 0,0011 | 0,99 | 0,0362 | 0,0018 |
| A12- | Innsbruck Mitte | A12 Innsbruck West | 0,71 | 0,1280 | 0,0022 | 0,71 | 0,1280 | 0,0035 | 1,00 | 0,1792 | 0,0052 | 1,00 | 0,1792 | 0,0081 | 1,44 | 0,2048 | 0,0065 | 1,44 | 0,2048 | 0,0102 |
| A12- | A12 Innsbruck West | Innsbruck Kranebitten | 0,93 | 0,1678 | 0,0029 | 0,94 | 0,1678 | 0,0046 | 1,31 | 0,2349 | 0,0068 | 1,32 | 0,2349 | 0,0106 | 1,88 | 0,2684 | 0,0085 | 1,89 | 0,2684 | 0,0134 |
| A12- | Innsbruck Kranebitten | Zirl Ost Garmisch Seefeld | 1,08 | 0,1947 | 0,0034 | 1,09 | 0,1947 | 0,0054 | 1,52 | 0,2726 | 0,0078 | 1,53 | 0,2726 | 0,0123 | 2,18 | 0,3115 | 0,0099 | 2,19 | 0,3115 | 0,0155 |
| A12- | Zirl Ost Garmisch Seefeld | Zirl West | 0,68 | 0,1218 | 0,0021 | 0,68 | 0,1218 | 0,0033 | 0,95 | 0,1705 | 0,0049 | 0,95 | 0,1705 | 0,0077 | 1,37 | 0,1949 | 0,0062 | 1,37 | 0,1949 | 0,0097 |
| A12- | Zirl West | Petttau | 1,22 | 0,2181 | 0,0038 | 1,22 | 0,2181 | 0,0060 | 1,71 | 0,3054 | 0,0088 | 1,71 | 0,3054 | 0,0138 | 2,45 | 0,3490 | 0,0111 | 2,45 | 0,3490 | 0,0174 |
| A12- | Petttau | Telfs Ost | 1,23 | 0,2205 | 0,0039 | 1,23 | 0,2205 | 0,0061 | 1,72 | 0,3087 | 0,0089 | 1,73 | 0,3087 | 0,0139 | 2,47 | 0,3528 | 0,0112 | 2,48 | 0,3528 | 0,0176 |
| A12- | Telfs Ost | Telfs West | 0,60 | 0,1077 | 0,0019 | 0,60 | 0,1077 | 0,0030 | 0,84 | 0,1508 | 0,0043 | 0,84 | 0,1508 | 0,0068 | 1,21 | 0,1723 | 0,0055 | 1,21 | 0,1723 | 0,0086 |
| A12- | Telfs West | Mötz Reutte | 1,94 | 0,3480 | 0,0061 | 1,94 | 0,3480 | 0,0096 | 2,72 | 0,4872 | 0,0140 | 2,73 | 0,4872 | 0,0220 | 3,90 | 0,5568 | 0,0177 | 3,91 | 0,5568 | 0,0278 |
| A12- | Mötz Reutte | Haiming Ötztal | 2,26 | 0,4048 | 0,0071 | 2,26 | 0,4048 | 0,0111 | 3,16 | 0,5667 | 0,0163 | 3,17 | 0,5667 | 0,0256 | 4,54 | 0,6477 | 0,0205 | 4,55 | 0,6477 | 0,0323 |
| A12- | Haiming Ötztal | Imst | 1,80 | 0,3222 | 0,0056 | 1,80 | 0,3222 | 0,0089 | 2,52 | 0,4511 | 0,0130 | 2,53 | 0,4511 | 0,0204 | 3,61 | 0,5156 | 0,0164 | 3,62 | 0,5156 | 0,0257 |
| A12- | Imst | Imst Au | 0,30 | 0,0546 | 0,0010 | 0,30 | 0,0546 | 0,0015 | 0,43 | 0,0764 | 0,0022 | 0,43 | 0,0764 | 0,0035 | 0,61 | 0,0873 | 0,0028 | 0,61 | 0,0873 | 0,0044 |
| A12- | Imst Au | Mils | 0,65 | 0,1172 | 0,0021 | 0,65 | 0,1172 | 0,0032 | 0,92 | 0,1641 | 0,0047 | 0,92 | 0,1641 | 0,0074 | 1,31 | 0,1875 | 0,0059 | 1,32 | 0,1875 | 0,0093 |
| A12- | Mils | Mils Schönwies | 1,05 | 0,1888 | 0,0033 | 1,05 | 0,1888 | 0,0052 | 1,48 | 0,2643 | 0,0076 | 1,48 | 0,2643 | 0,0119 | 2,12 | 0,3021 | 0,0096 | 2,12 | | |

| | | | | | | | | | | | | | | | | | | | | |
|------|------------------------------------|------------------------------------|------|--------|--------|------|--------|--------|------|--------|--------|------|--------|--------|------|--------|--------|------|--------|--------|
| A14- | Staatsgrenze Hörbranz | Hörbranz Lochau | 0,28 | 0,0504 | 0,0009 | 0,28 | 0,0504 | 0,0014 | 0,39 | 0,0706 | 0,0020 | 0,40 | 0,0706 | 0,0032 | 0,57 | 0,0807 | 0,0026 | 0,57 | 0,0807 | 0,0040 |
| A14- | Hörbranz Lochau | KN Bregenz | 1,73 | 0,3100 | 0,0054 | 1,73 | 0,3100 | 0,0085 | 2,42 | 0,4339 | 0,0125 | 2,43 | 0,4339 | 0,0196 | 3,48 | 0,4959 | 0,0157 | 3,49 | 0,4959 | 0,0247 |
| A14- | KN Bregenz | Lauterach Wolfurt | 0,09 | 0,0156 | 0,0003 | 0,09 | 0,0156 | 0,0004 | 0,12 | 0,0218 | 0,0006 | 0,12 | 0,0218 | 0,0010 | 0,17 | 0,0249 | 0,0008 | 0,17 | 0,0249 | 0,0012 |
| A14- | Lauterach Wolfurt | Wolfurt Lauterach | 0,77 | 0,1379 | 0,0024 | 0,77 | 0,1379 | 0,0038 | 1,08 | 0,1931 | 0,0056 | 1,08 | 0,1931 | 0,0087 | 1,55 | 0,2207 | 0,0070 | 1,55 | 0,2207 | 0,0110 |
| A14- | Wolfurt Lauterach | Dornbirn Nord Bregenzerwald | 0,30 | 0,0534 | 0,0009 | 0,30 | 0,0534 | 0,0015 | 0,42 | 0,0747 | 0,0021 | 0,42 | 0,0747 | 0,0034 | 0,60 | 0,0854 | 0,0027 | 0,60 | 0,0854 | 0,0043 |
| A14- | Dornbirn Nord Bregenzerwald | Dornbirn Süd Lustenau | 0,83 | 0,1491 | 0,0026 | 0,83 | 0,1491 | 0,0041 | 1,17 | 0,2087 | 0,0060 | 1,17 | 0,2087 | 0,0094 | 1,67 | 0,2385 | 0,0076 | 1,68 | 0,2385 | 0,0119 |
| A14- | Dornbirn Süd Lustenau | Hohenems | 1,17 | 0,2098 | 0,0037 | 1,17 | 0,2098 | 0,0058 | 1,64 | 0,2937 | 0,0084 | 1,64 | 0,2937 | 0,0133 | 2,35 | 0,3356 | 0,0106 | 2,36 | 0,3356 | 0,0167 |
| A14- | Hohenems | Altach Götzis | 0,76 | 0,1368 | 0,0024 | 0,76 | 0,1368 | 0,0038 | 1,07 | 0,1915 | 0,0055 | 1,07 | 0,1915 | 0,0087 | 1,53 | 0,2188 | 0,0069 | 1,54 | 0,2188 | 0,0109 |
| A14- | Altach Götzis | Götzis | 0,58 | 0,1043 | 0,0018 | 0,58 | 0,1043 | 0,0029 | 0,82 | 0,1460 | 0,0042 | 0,82 | 0,1460 | 0,0066 | 1,17 | 0,1668 | 0,0053 | 1,17 | 0,1668 | 0,0083 |
| A14- | Götzis | Klaus Koblach | 0,50 | 0,0906 | 0,0016 | 0,51 | 0,0906 | 0,0025 | 0,71 | 0,1268 | 0,0036 | 0,71 | 0,1268 | 0,0057 | 1,02 | 0,1449 | 0,0046 | 1,02 | 0,1449 | 0,0072 |
| A14- | Klaus Koblach | Rankweil | 0,89 | 0,1592 | 0,0028 | 0,89 | 0,1592 | 0,0044 | 1,24 | 0,2228 | 0,0064 | 1,25 | 0,2228 | 0,0101 | 1,79 | 0,2547 | 0,0081 | 1,79 | 0,2547 | 0,0127 |
| A14- | Rankweil | Feldkirch Frastanz | 1,26 | 0,2267 | 0,0040 | 1,27 | 0,2267 | 0,0062 | 1,77 | 0,3174 | 0,0091 | 1,78 | 0,3174 | 0,0143 | 2,54 | 0,3628 | 0,0115 | 2,55 | 0,3628 | 0,0181 |
| A14- | Feldkirch Frastanz | Nenzing Bludesch | 2,00 | 0,3585 | 0,0063 | 2,00 | 0,3585 | 0,0099 | 2,80 | 0,5019 | 0,0144 | 2,81 | 0,5019 | 0,0227 | 4,02 | 0,5736 | 0,0182 | 4,03 | 0,5736 | 0,0286 |
| A14- | Nenzing Bludesch | Bludenz Nüziders | 1,48 | 0,2662 | 0,0047 | 1,49 | 0,2662 | 0,0073 | 2,08 | 0,3726 | 0,0107 | 2,09 | 0,3726 | 0,0168 | 2,99 | 0,4259 | 0,0135 | 2,99 | 0,4259 | 0,0212 |
| A14- | Bludenz Nüziders | Brandnertal | 0,21 | 0,0370 | 0,0006 | 0,21 | 0,0370 | 0,0010 | 0,29 | 0,0519 | 0,0015 | 0,29 | 0,0519 | 0,0023 | 0,42 | 0,0593 | 0,0019 | 0,42 | 0,0593 | 0,0030 |
| A14- | Brandnertal | Bludenz Bürs | 0,34 | 0,0618 | 0,0011 | 0,35 | 0,0618 | 0,0017 | 0,48 | 0,0865 | 0,0025 | 0,48 | 0,0865 | 0,0039 | 0,69 | 0,0989 | 0,0031 | 0,69 | 0,0989 | 0,0049 |
| A14- | Bludenz Bürs | Bludenz Montafon | 0,49 | 0,0876 | 0,0015 | 0,49 | 0,0876 | 0,0024 | 0,68 | 0,1226 | 0,0035 | 0,69 | 0,1226 | 0,0055 | 0,98 | 0,1402 | 0,0044 | 0,99 | 0,1402 | 0,0070 |
| A141 | KN Bregenz | Bregenz Citytunnel | 0,45 | 0,0802 | 0,0014 | 0,45 | 0,0802 | 0,0022 | 0,63 | 0,1123 | 0,0032 | 0,63 | 0,1123 | 0,0051 | 0,90 | 0,1284 | 0,0041 | 0,90 | 0,1284 | 0,0064 |
| A21- | KN Steinhäusl | Hochstraß | 0,74 | 0,1324 | 0,0023 | 0,74 | 0,1324 | 0,0036 | 1,03 | 0,1853 | 0,0053 | 1,04 | 0,1853 | 0,0084 | 1,48 | 0,2118 | 0,0067 | 1,49 | 0,2118 | 0,0106 |
| A21- | Hochstraß | Alland | 2,58 | 0,4624 | 0,0081 | 2,58 | 0,4624 | 0,0127 | 3,62 | 0,6474 | 0,0186 | 3,63 | 0,6474 | 0,0292 | 5,19 | 0,7399 | 0,0235 | 5,20 | 0,7399 | 0,0369 |
| A21- | Alland | Mayerling | 0,52 | 0,0939 | 0,0016 | 0,52 | 0,0939 | 0,0026 | 0,73 | 0,1314 | 0,0038 | 0,74 | 0,1314 | 0,0059 | 1,05 | 0,1502 | 0,0048 | 1,06 | 0,1502 | 0,0075 |
| A21- | Mayerling | Heiligenkreuz | 1,21 | 0,2175 | 0,0038 | 1,21 | 0,2175 | 0,0060 | 1,70 | 0,3045 | 0,0088 | 1,71 | 0,3045 | 0,0138 | 2,44 | 0,3480 | 0,0110 | 2,45 | 0,3480 | 0,0173 |
| A21- | Heiligenkreuz | Heiligenbrühl | 0,68 | 0,1212 | 0,0021 | 0,68 | 0,1212 | 0,0033 | 0,95 | 0,1697 | 0,0049 | 0,95 | 0,1697 | 0,0077 | 1,36 | 0,1940 | 0,0062 | 1,36 | 0,1940 | 0,0097 |
| A21- | Hinterbrühl | Gießhübl | 1,27 | 0,2274 | 0,0040 | 1,27 | 0,2274 | 0,0063 | 1,78 | 0,3184 | 0,0092 | 1,78 | 0,3184 | 0,0144 | 2,55 | 0,3638 | 0,0115 | 2,56 | 0,3638 | 0,0181 |
| A21- | Gießhübl | Brunn/Gebirge | 1,06 | 0,1903 | 0,0033 | 1,06 | 0,1903 | 0,0052 | 1,49 | 0,2664 | 0,0077 | 1,49 | 0,2664 | 0,0120 | 2,13 | 0,3044 | 0,0097 | 2,14 | 0,3044 | 0,0152 |
| A21- | Brunn/Gebirge | KN Vösendorf | 0,47 | 0,0846 | 0,0015 | 0,47 | 0,0846 | 0,0023 | 0,66 | 0,1185 | 0,0034 | 0,66 | 0,1185 | 0,0054 | 0,95 | 0,1354 | 0,0043 | 0,95 | 0,1354 | 0,0068 |
| A22- | KN Wien Kaisermühlen | Kaisermühlen | 0,37 | 0,0669 | 0,0012 | 0,37 | 0,0669 | 0,0018 | 0,52 | 0,0936 | 0,0027 | 0,52 | 0,0936 | 0,0042 | 0,75 | 0,1070 | 0,0034 | 0,75 | 0,1070 | 0,0053 |
| A22- | Kaisermühlen | Reichsbrücke | 0,31 | 0,0554 | 0,0010 | 0,31 | 0,0554 | 0,0015 | 0,43 | 0,0776 | 0,0022 | 0,43 | 0,0776 | 0,0035 | 0,62 | 0,0887 | 0,0028 | 0,62 | 0,0887 | 0,0044 |
| A22- | Reichsbrücke | Kagran Vienna International Center | 0,12 | 0,0214 | 0,0004 | 0,12 | 0,0214 | 0,0006 | 0,17 | 0,0299 | 0,0009 | 0,17 | 0,0299 | 0,0014 | 0,24 | 0,0342 | 0,0011 | 0,24 | 0,0342 | 0,0017 |
| A22- | Kagran Vienna International Center | Brigittenauebrücke | 0,19 | 0,0342 | 0,0006 | 0,19 | 0,0342 | 0,0009 | 0,27 | 0,0479 | 0,0014 | 0,27 | 0,0479 | 0,0022 | 0,38 | 0,0547 | 0,0017 | 0,38 | 0,0547 | 0,0027 |
| A22- | Brigittenauebrücke | Floridsdorferbrücke | 0,31 | 0,0552 | 0,0010 | 0,31 | 0,0552 | 0,0015 | 0,43 | 0,0773 | 0,0022 | 0,43 | 0,0773 | 0,0035 | 0,62 | 0,0883 | 0,0028 | 0,62 | 0,0883 | 0,0044 |
| A22- | Floridsdorferbrücke | KN Gürtel Nordbrücke | 0,20 | 0,0352 | 0,0006 | 0,20 | 0,0352 | 0,0010 | 0,28 | 0,0493 | 0,0014 | 0,28 | 0,0493 | 0,0022 | 0,39 | 0,0563 | 0,0018 | 0,40 | 0,0563 | 0,0028 |
| A22- | KN Gürtel Nordbrücke | Strebersdorf | 0,67 | 0,1203 | 0,0021 | 0,67 | 0,1203 | 0,0033 | 0,94 | 0,1684 | 0,0048 | 0,94 | 0,1684 | 0,0076 | 1,35 | 0,1925 | 0,0061 | 1,35 | 0,1925 | 0,0096 |
| A221 | Wien Nordbrücke | KN Gürtel Nordbrücke | 0,20 | 0,0355 | 0,0006 | 0,20 | 0,0355 | 0,0010 | 0,28 | 0,0497 | 0,0014 | 0,28 | 0,0497 | 0,0022 | 0,40 | 0,0568 | 0,0018 | 0,40 | 0,0568 | 0,0028 |
| A221 | KN Gürtel Nordbrücke | Wien Pragerstraße | 0,21 | 0,0382 | 0,0007 | 0,21 | 0,0382 | 0,0010 | 0,30 | 0,0535 | 0,0015 | 0,30 | 0,0535 | 0,0024 | 0,43 | 0,0611 | 0,0019 | 0,43 | 0,0611 | 0,0030 |
| A221 | Wien Pragerstraße | Wien Neujedlersdorf | 0,09 | 0,0167 | 0,0003 | 0,09 | 0,0167 | 0,0005 | 0,13 | 0,0234 | 0,0007 | 0,13 | 0,0234 | 0,0011 | 0,19 | 0,0268 | 0,0008 | 0,19 | 0,0268 | 0,0013 |
| A221 | Wien Neujedlersdorf | Brünnerstr/Shuttlewortstraße | 0,24 | 0,0424 | 0,0007 | 0,24 | 0,0424 | 0,0012 | 0,33 | 0,0594 | 0,0017 | 0,33 | 0,0594 | 0,0027 | 0,48 | 0,0678 | 0,0022 | 0,48 | 0,0678 | 0,0034 |
| A22- | Strebersdorf | Korneuburg Ost | 1,35 | 0,2424 | 0,0042 | 1,35 | 0,2424 | 0,0067 | 1,90 | 0,3394 | 0,0098 | 1,90 | 0,3394 | 0,0153 | 2,72 | 0,3878 | 0,0123 | 2,73 | 0,3878 | 0,0193 |
| A222 | Strebersdorf | Wien Vohburggasse | 0,17 | 0,0301 | 0,0005 | 0,17 | 0,0301 | 0,0008 | 0,24 | 0,0422 | 0,0012 | 0,24 | 0,0422 | 0,0019 | 0,34 | 0,0482 | 0,0015 | 0,34 | 0,0482 | 0,0024 |
| A22- | Korneuburg Ost | KN Korneuburg | 0,87 | 0,1564 | 0,0027 | 0,87 | 0,1564 | 0,0043 | 1,22 | 0,2190 | 0,0063 | 1,23 | 0,2190 | 0,0099 | 1,75 | 0,2503 | 0,0079 | 1,76 | 0,2503 | 0,0125 |
| A22- | KN Korneuburg | Stockerau Ost | 1,27 | 0,2276 | 0,0040 | 1,27 | 0,2276 | 0,0063 | 1,78 | 0,3186 | 0,0092 | 1,78 | 0,3186 | 0,0144 | 2,55 | 0,3642 | 0,0116 | 2,56 | 0,3642 | 0,0182 |
| A22- | Stockerau Ost | Stockerau Mitte | 0,51 | 0,0908 | 0,0016 | 0,51 | 0,0908 | 0,0025 | 0,71 | 0,1271 | 0,0037 | 0,71 | 0,1271 | 0,0057 | 1,02 | 0,1452 | 0,0046 | 1,02 | 0,1452 | 0,0072 |
| A22- | Stockerau Mitte | KN Stockerau/West | 0,43 | 0,0771 | 0,0013 | 0,43 | 0,0771 | 0,0021 | 0,60 | 0,1079 | 0,0031 | 0,60 | 0,1079 | 0,0049 | 0,86 | 0,1233 | 0,0039 | 0,87 | 0,1233 | 0,0061 |
| A23- | Altmannsdorferstraße | KN Wien Inzersdorf | 0,38 | 0,0674 | 0,0012 | 0,38 | 0,0674 | 0,0019 | 0,53 | 0,0944 | 0,0027 | 0,53 | 0,0944 | 0,0043 | 0,76 | 0,1079 | 0,0034 | 0,76 | 0,1079 | 0,0054 |
| A23- | KN Wien Inzersdorf | Favoriten | 0,95 | 0,1701 | 0,0030 | 0,95 | 0,1701 | 0,0047 | 1,33 | 0,2381 | 0,0068 | 1,33 | 0,2381 | 0,0108 | 1,91 | 0,2721 | 0,0086 | 1,91 | 0,2721 | 0,0136 |
| A23- | Favoriten | KN Gürtel Landstraßer Hauptstraße | 0,59 | 0,1065 | 0,0019 | 0,59 | 0,1065 | 0,0029 | 0,83 | 0,1491 | 0,0043 | 0,84 | 0,1491 | 0,0067 | 1,19 | 0,1704 | 0,0054 | 1,20 | 0,1704 | 0,0085 |
| A23- | KN Gürtel Landstraßer Hauptstraße | St. Marx | 0,23 | 0,0404 | 0,0007 | 0,23 | 0,0404 | 0,0011 | 0,32 | 0,0566 | 0,0016 | 0,32 | 0,0566 | 0,0026 | 0,45 | 0,0647 | 0,0021 | 0,45 | 0,0647 | 0,0032 |
| A23- | St. Marx | KN Wien Prater | 0,19 | 0,0343 | 0,0006 | 0,19 | 0,0343 | 0,0009 | 0,27 | 0,0480 | 0,0014 | 0,27 | 0,0480 | 0,0022 | 0,38 | 0,0549 | 0,0017 | 0,39 | 0,0549 | 0,0027 |
| A23- | KN Wien Prater | Handelskai | 0,42 | 0,0762 | 0,0013 | 0,43 | 0,0762 | 0,0021 | 0,60 | 0,1067 | 0,0031 | 0,60 | 0,1067 | 0,0048 | 0,85 | 0,1219 | 0,0039 | 0,86 | 0,1219 | 0,0061 |
| A23- | Handelskai | KN Wien Kaisermühlen | 0,19 | 0,0348 | 0,0006 | 0,19 | 0,0348 | 0,0010 | 0,27 | 0,0488 | 0,0014 | 0,27 | 0,0488 | 0,0022 | 0,39 | 0,0557 | 0,0018 | 0,39 | 0,0557 | 0,0028 |
| A23- | KN Wien Kaisermühlen | Groß Enzersdorf Stadlau | 0,53 | 0,0956 | 0,0017 | 0,53 | 0,0956 | 0,0026 | 0,75 | 0,1338 | 0,0038 | 0,75 | 0,1338 | 0,0060 | 1,07 | 0,1530 | 0,0049 | 1,08 | 0,1530 | 0,0076 |
| A23- | Groß Enzersdorf Stadlau | Hirschstetten | 0,30 | 0,0536 | 0,0009 | 0,30 | 0,0536 | 0,0015 | 0,42 | 0,0750 | 0,0022 | 0,42 | 0,0750 | 0,0034 | 0,60 | 0,0858 | 0,0027 | 0,60 | 0,0858 | 0,0043 |
| A233 | KN Gürtel Landstraßer Hauptstraße | Wien Gürtel | 0,17 | 0,0313 | 0,0005 | 0,17 | 0,0313 | 0,0009 | 0,24 | 0,0438 | 0,0013 | 0,25 | 0,0438 | 0,0020 | 0,35 | 0,0500 | 0,0016 | 0,35 | 0,0500 | 0,0025 |
| A25- | KN A1/A25 Passau Wels | Weißkirchen | 1,96 | 0,3526 | 0,0062 | 1,97 | 0,3526 | 0,0097 | 2,76 | 0,4936 | 0,0142 | 2,76 | 0,4936 | 0,0223 | 3,95 | 0,5642 | 0,0179 | 3,97 | 0,5642 | 0,0281 |
| A25- | Weißkirchen | Marchtrenk Wels Ost | 0,70 | 0,1256 | 0,0022 | 0,70 | 0,1256 | 0,0035 | 0,98 | 0,1759 | 0,0051 | 0,99 | 0,1759 | 0,0079 | 1,41 | 0,2010 | 0,0064 | 1,41 | 0,2010 | 0,0100 |
| A25- | Marchtrenk Wels Ost | ÖBB Terminal Wels | 0,19 | 0,0338 | 0,0006 | 0,19 | 0,0338 | 0,0009 | 0,26 | 0,0473 | 0,0014 | 0,26 | 0,0473 | 0,0021 | 0,38 | 0,0541 | 0,0017 | 0,38 | 0,0541 | 0,0027 |
| | | | | | | | | | | | | | | | | | | | | |

| | | | | | | | | | | | | | | | | | | | | |
|------|-----------------------------------|-----------------------------------|------|--------|--------|------|--------|--------|------|--------|--------|------|--------|--------|------|--------|--------|------|----------|--------|
| S01- | Seyring | KN Eibesbrunn | 0,92 | 0,1649 | 0,0029 | 0,92 | 0,1649 | 0,0045 | 1,29 | 0,2308 | 0,0066 | 1,29 | 0,2308 | 0,0104 | 1,85 | 0,2638 | 0,0084 | 1,85 | 0,2638 | 0,0131 |
| S01- | KN Eibesbrunn | Hagenbrunn | 0,72 | 0,1298 | 0,0023 | 0,72 | 0,1298 | 0,0036 | 1,01 | 0,1817 | 0,0052 | 1,02 | 0,1817 | 0,0082 | 1,46 | 0,2077 | 0,0066 | 1,46 | 0,2077 | 0,0104 |
| S01- | Hagenbrunn | Korneuburg Nord | 1,55 | 0,2777 | 0,0049 | 1,55 | 0,2777 | 0,0076 | 2,17 | 0,3888 | 0,0112 | 2,18 | 0,3888 | 0,0176 | 3,11 | 0,4443 | 0,0141 | 3,12 | 0,4443 | 0,0221 |
| S01- | Korneuburg Nord | Korneuburg West | 0,63 | 0,1126 | 0,0020 | 0,63 | 0,1126 | 0,0031 | 0,88 | 0,1577 | 0,0045 | 0,88 | 0,1577 | 0,0071 | 1,26 | 0,1802 | 0,0057 | 1,27 | 0,1802 | 0,0090 |
| S01- | Korneuburg West | KN Korneuburg | 0,20 | 0,0359 | 0,0006 | 0,20 | 0,0359 | 0,0010 | 0,28 | 0,0503 | 0,0014 | 0,28 | 0,0503 | 0,0023 | 0,40 | 0,0575 | 0,0018 | 0,40 | 0,0575 | 0,0029 |
| S02- | Hirschstetten | Gewerbepark Stadlau | 0,22 | 0,0386 | 0,0007 | 0,22 | 0,0386 | 0,0011 | 0,30 | 0,0540 | 0,0016 | 0,30 | 0,0540 | 0,0024 | 0,43 | 0,0618 | 0,0020 | 0,43 | 0,0618 | 0,0031 |
| S02- | Gewerbepark Stadlau | Breitenleer Straße | 0,12 | 0,0214 | 0,0004 | 0,12 | 0,0214 | 0,0006 | 0,17 | 0,0300 | 0,0009 | 0,17 | 0,0300 | 0,0014 | 0,24 | 0,0342 | 0,0011 | 0,24 | 0,0342 | 0,0017 |
| S02- | Breitenleer Straße | Rautenweg | 0,20 | 0,0355 | 0,0006 | 0,20 | 0,0355 | 0,0010 | 0,28 | 0,0497 | 0,0014 | 0,28 | 0,0497 | 0,0022 | 0,40 | 0,0568 | 0,0018 | 0,40 | 0,0568 | 0,0028 |
| S02- | Rautenweg | Hermann Gebauer Straße | 0,22 | 0,0390 | 0,0007 | 0,22 | 0,0390 | 0,0011 | 0,31 | 0,0547 | 0,0016 | 0,31 | 0,0547 | 0,0025 | 0,44 | 0,0625 | 0,0020 | 0,44 | 0,0625 | 0,0031 |
| S02- | Hermann Gebauer Straße | Angerner Straße | 0,79 | 0,1413 | 0,0025 | 0,79 | 0,1413 | 0,0039 | 1,10 | 0,1978 | 0,0057 | 1,11 | 0,1978 | 0,0089 | 1,58 | 0,2260 | 0,0072 | 1,59 | 0,2260 | 0,0113 |
| S03- | KN Stockerau/West | Stockerau Nord | 0,22 | 0,0399 | 0,0007 | 0,22 | 0,0399 | 0,0011 | 0,31 | 0,0559 | 0,0016 | 0,31 | 0,0559 | 0,0025 | 0,45 | 0,0639 | 0,0020 | 0,45 | 0,0639 | 0,0032 |
| S03- | Stockerau Nord | Sierndorf | 1,20 | 0,2146 | 0,0038 | 1,20 | 0,2146 | 0,0059 | 1,68 | 0,3004 | 0,0086 | 1,68 | 0,3004 | 0,0136 | 2,41 | 0,3433 | 0,0109 | 2,41 | 0,3433 | 0,0171 |
| S03- | Sierndorf | Obermallebarn | 0,80 | 0,1441 | 0,0025 | 0,80 | 0,1441 | 0,0040 | 1,13 | 0,2017 | 0,0058 | 1,13 | 0,2017 | 0,0091 | 1,62 | 0,2305 | 0,0073 | 1,62 | 0,2305 | 0,0115 |
| S03- | Obermallebarn | Göllersdorf | 1,06 | 0,1902 | 0,0033 | 1,06 | 0,1902 | 0,0052 | 1,49 | 0,2663 | 0,0077 | 1,49 | 0,2663 | 0,0120 | 2,13 | 0,3044 | 0,0097 | 2,14 | 0,3044 | 0,0152 |
| S03- | Göllersdorf | Großstelzendorf | 0,42 | 0,0762 | 0,0013 | 0,43 | 0,0762 | 0,0021 | 0,60 | 0,1067 | 0,0031 | 0,60 | 0,1067 | 0,0048 | 0,85 | 0,1219 | 0,0039 | 0,86 | 0,1219 | 0,0061 |
| S03- | Großstelzendorf | Hollabrunn Süd | 1,02 | 0,1832 | 0,0032 | 1,02 | 0,1832 | 0,0050 | 1,43 | 0,2565 | 0,0074 | 1,44 | 0,2565 | 0,0116 | 2,06 | 0,2932 | 0,0093 | 2,06 | 0,2932 | 0,0146 |
| S04- | KN Mattersburg | Sigleß | 0,53 | 0,0947 | 0,0017 | 0,53 | 0,0947 | 0,0026 | 0,74 | 0,1326 | 0,0038 | 0,74 | 0,1326 | 0,0060 | 1,06 | 0,1516 | 0,0048 | 1,07 | 0,1516 | 0,0076 |
| S04- | Sigleß | Bad Sauerbrunn | 1,23 | 0,2213 | 0,0039 | 1,24 | 0,2213 | 0,0061 | 1,73 | 0,3098 | 0,0089 | 1,74 | 0,3098 | 0,0140 | 2,48 | 0,3541 | 0,0112 | 2,49 | 0,3541 | 0,0177 |
| S04- | Bad Sauerbrunn | Neudörfel | 0,52 | 0,0930 | 0,0016 | 0,52 | 0,0930 | 0,0026 | 0,73 | 0,1302 | 0,0037 | 0,73 | 0,1302 | 0,0059 | 1,04 | 0,1488 | 0,0047 | 1,05 | 0,1488 | 0,0074 |
| S04- | Neudörfel | Wr. Neustadt Ost | 0,54 | 0,0974 | 0,0017 | 0,54 | 0,0974 | 0,0027 | 0,76 | 0,1363 | 0,0039 | 0,76 | 0,1363 | 0,0062 | 1,09 | 0,1558 | 0,0049 | 1,09 | 0,1558 | 0,0078 |
| S04- | Wr. Neustadt Ost | Katzelsdorf | 0,25 | 0,0456 | 0,0008 | 0,25 | 0,0456 | 0,0013 | 0,36 | 0,0638 | 0,0018 | 0,36 | 0,0638 | 0,0029 | 0,51 | 0,0730 | 0,0023 | 0,51 | 0,0730 | 0,0036 |
| S04- | Katzelsdorf | Lanzenkirchen | 0,21 | 0,0382 | 0,0007 | 0,21 | 0,0382 | 0,0010 | 0,30 | 0,0534 | 0,0015 | 0,30 | 0,0534 | 0,0024 | 0,43 | 0,0611 | 0,0019 | 0,43 | 0,0611 | 0,0030 |
| S04- | Lanzenkirchen | Wr. Neustadt Süd | 0,19 | 0,0338 | 0,0006 | 0,19 | 0,0338 | 0,0009 | 0,26 | 0,0474 | 0,0014 | 0,27 | 0,0474 | 0,0021 | 0,38 | 0,0541 | 0,0017 | 0,38 | 0,0541 | 0,0027 |
| S04- | Wr. Neustadt Süd | KN Wr. Neustadt | 0,31 | 0,0560 | 0,0010 | 0,31 | 0,0560 | 0,0015 | 0,44 | 0,0784 | 0,0023 | 0,44 | 0,0784 | 0,0035 | 0,63 | 0,0896 | 0,0028 | 0,63 | 0,0896 | 0,0045 |
| S05- | KN Stockerau/West | Tulln | 2,15 | 0,3864 | 0,0068 | 2,16 | 0,3864 | 0,0106 | 3,02 | 0,5410 | 0,0156 | 3,03 | 0,5410 | 0,0244 | 4,33 | 0,6182 | 0,0196 | 4,35 | 0,6182 | 0,0308 |
| S05- | Tulln | Königsbrunn / Wagram | 2,70 | 0,4840 | 0,0085 | 2,70 | 0,4840 | 0,0133 | 3,78 | 0,6776 | 0,0195 | 3,79 | 0,6776 | 0,0306 | 5,43 | 0,7744 | 0,0246 | 5,44 | 0,7744 | 0,0386 |
| S05- | Königsbrunn / Wagram | Kirchberg/Wagram | 0,72 | 0,1290 | 0,0023 | 0,72 | 0,1290 | 0,0035 | 1,01 | 0,1806 | 0,0052 | 1,01 | 0,1806 | 0,0082 | 1,45 | 0,2064 | 0,0065 | 1,45 | 0,2064 | 0,0103 |
| S05- | Kirchberg/Wagram | Fels / Wagram | 0,54 | 0,0966 | 0,0017 | 0,54 | 0,0966 | 0,0027 | 0,76 | 0,1353 | 0,0039 | 0,76 | 0,1353 | 0,0061 | 1,08 | 0,1546 | 0,0049 | 1,09 | 0,1546 | 0,0077 |
| S05- | Fels / Wagram | Grafenwörth | 1,24 | 0,2225 | 0,0039 | 1,24 | 0,2225 | 0,0061 | 1,74 | 0,3115 | 0,0090 | 1,74 | 0,3115 | 0,0141 | 2,50 | 0,3560 | 0,0113 | 2,50 | 0,3560 | 0,0177 |
| S05- | Grafenwörth | Jettsdorf | 0,55 | 0,0995 | 0,0017 | 0,56 | 0,0995 | 0,0027 | 0,78 | 0,1393 | 0,0040 | 0,78 | 0,1393 | 0,0063 | 1,12 | 0,1592 | 0,0050 | 1,12 | 0,1592 | 0,0079 |
| S06- | KN Seebein | Neunkirchen | 0,85 | 0,1518 | 0,0027 | 0,85 | 0,1518 | 0,0042 | 1,19 | 0,2125 | 0,0061 | 1,19 | 0,2125 | 0,0096 | 1,70 | 0,2429 | 0,0077 | 1,71 | 0,2429 | 0,0121 |
| S06- | Neunkirchen | Gloggnitz | 2,71 | 0,4868 | 0,0085 | 2,72 | 0,4868 | 0,0134 | 3,81 | 0,6815 | 0,0196 | 3,82 | 0,6815 | 0,0308 | 5,46 | 0,7789 | 0,0247 | 5,47 | 0,7789 | 0,0388 |
| S06- | Gloggnitz | Maria Schutz | 1,73 | 0,3103 | 0,0054 | 1,73 | 0,3103 | 0,0085 | 2,43 | 0,4344 | 0,0125 | 2,43 | 0,4344 | 0,0196 | 3,48 | 0,4964 | 0,0157 | 3,49 | 0,4964 | 0,0247 |
| S06- | Maria Schutz | Spital / Semmering | 1,47 | 0,2634 | 0,0046 | 1,47 | 0,2634 | 0,0072 | 2,06 | 0,3687 | 0,0106 | 2,06 | 0,3687 | 0,0167 | 2,95 | 0,4214 | 0,0134 | 2,96 | 0,4214 | 0,0210 |
| S06- | Spital / Semmering | Mürzzuschlag Ost | 1,23 | 0,2200 | 0,0039 | 1,23 | 0,2200 | 0,0061 | 1,72 | 0,3080 | 0,0089 | 1,72 | 0,3080 | 0,0139 | 2,47 | 0,3520 | 0,0112 | 2,47 | 0,3520 | 0,0175 |
| S06- | Mürzzuschlag Ost | Mariazell, Mürzsteg, Mürzzuschlag | 1,09 | 0,1950 | 0,0034 | 1,09 | 0,1950 | 0,0054 | 1,52 | 0,2731 | 0,0079 | 1,53 | 0,2731 | 0,0123 | 2,19 | 0,3121 | 0,0099 | 2,19 | 0,3121 | 0,0156 |
| S06- | Mariazell, Mürzsteg, Mürzzuschlag | Hönigsberg | 0,78 | 0,1391 | 0,0024 | 0,78 | 0,1391 | 0,0038 | 1,09 | 0,1947 | 0,0056 | 1,09 | 0,1947 | 0,0088 | 1,56 | 0,2225 | 0,0071 | 1,56 | 0,2225 | 0,0111 |
| S06- | Hönigsberg | Langenwang | 0,43 | 0,0769 | 0,0013 | 0,43 | 0,0769 | 0,0021 | 0,60 | 0,1077 | 0,0031 | 0,60 | 0,1077 | 0,0049 | 0,86 | 0,1231 | 0,0039 | 0,87 | 0,1231 | 0,0061 |
| S06- | Langenwang | Krieglach | 0,51 | 0,0914 | 0,0016 | 0,51 | 0,0914 | 0,0025 | 0,71 | 0,1279 | 0,0037 | 0,72 | 0,1279 | 0,0058 | 1,02 | 0,1462 | 0,0046 | 1,03 | 0,1462 | 0,0073 |
| S06- | Krieglach | Mitterdorf | 1,29 | 0,2309 | 0,0040 | 1,29 | 0,2309 | 0,0064 | 1,81 | 0,3233 | 0,0093 | 1,81 | 0,3233 | 0,0146 | 2,59 | 0,3695 | 0,0117 | 2,60 | 0,3695 | 0,0184 |
| S06- | Mitterdorf | Kindberg Ost | 1,31 | 0,2348 | 0,0041 | 1,31 | 0,2348 | 0,0065 | 1,84 | 0,3287 | 0,0095 | 1,84 | 0,3287 | 0,0149 | 2,63 | 0,3757 | 0,0119 | 2,64 | 0,3757 | 0,0187 |
| S06- | Kindberg Ost | Kindberg West | 0,28 | 0,0504 | 0,0009 | 0,28 | 0,0504 | 0,0014 | 0,39 | 0,0706 | 0,0020 | 0,40 | 0,0706 | 0,0032 | 0,57 | 0,0806 | 0,0026 | 0,57 | 0,0806 | 0,0040 |
| S06- | Kindberg West | Kindberg Dörfel | 0,28 | 0,0504 | 0,0009 | 0,28 | 0,0504 | 0,0014 | 0,39 | 0,0705 | 0,0020 | 0,39 | 0,0705 | 0,0032 | 0,56 | 0,0806 | 0,0026 | 0,57 | 0,0806 | 0,0040 |
| S06- | Kindberg Dörfel | Allerheiligen Mürzhofen | 0,63 | 0,1134 | 0,0020 | 0,63 | 0,1134 | 0,0031 | 0,89 | 0,1588 | 0,0046 | 0,89 | 0,1588 | 0,0072 | 1,27 | 0,1815 | 0,0058 | 1,28 | 0,1815 | 0,0090 |
| S06- | Allerheiligen Mürzhofen | St. Marein | 0,95 | 0,1704 | 0,0030 | 0,95 | 0,1704 | 0,0047 | 1,33 | 0,2386 | 0,0069 | 1,34 | 0,2386 | 0,0108 | 1,91 | 0,2726 | 0,0086 | 1,92 | 0,2726 | 0,0136 |
| S06- | St. Marein | Kapfenberg | 0,67 | 0,1208 | 0,0021 | 0,67 | 0,1208 | 0,0033 | 0,94 | 0,1691 | 0,0049 | 0,95 | 0,1691 | 0,0076 | 1,35 | 0,1933 | 0,0061 | 1,36 | 0,1933 | 0,0096 |
| S06- | Kapfenberg | KN Bruck/Mur | 1,26 | 0,2255 | 0,0039 | 1,26 | 0,2255 | 0,0062 | 1,76 | 0,3157 | 0,0091 | 1,77 | 0,3157 | 0,0143 | 2,53 | 0,3608 | 0,0114 | 2,54 | 0,3608 | 0,0180 |
| S06- | KN Bruck/Mur | ASt Bruck/Mur | 1,08 | 0,1934 | 0,0034 | 1,08 | 0,1934 | 0,0053 | 1,51 | 0,2708 | 0,0078 | 1,52 | 0,2708 | 0,0122 | 2,17 | 0,3095 | 0,0098 | 2,18 | 0,3095 | 0,0154 |
| S06- | ASt Bruck/Mur | Niklasdorf | 1,00 | 0,1787 | 0,0031 | 1,00 | 0,1787 | 0,0049 | 1,40 | 0,2502 | 0,0072 | 1,40 | 0,2502 | 0,0113 | 2,00 | 0,2860 | 0,0091 | 2,01 | 0,2860 | 0,0143 |
| S06- | Niklasdorf | Leoben Ost | 1,06 | 0,1906 | 0,0033 | 1,06 | 0,1906 | 0,0052 | 1,49 | 0,2669 | 0,0077 | 1,49 | 0,2669 | 0,0121 | 2,14 | 0,3050 | 0,0097 | 2,14 | 0,3050 | 0,0152 |
| S06- | Leoben Ost | Leoben West | 1,19 | 0,2136 | 0,0037 | 1,19 | 0,2136 | 0,0059 | 1,67 | 0,2990 | 0,0086 | 1,67 | 0,2990 | 0,0135 | 2,40 | 0,3417 | 0,0108 | 2,40 | 0,3417</ | |

| | | | | | | | | | | | | | | | | | | | | |
|------|-----------------------------|-----------------------------|------|--------|--------|------|--------|--------|------|--------|--------|------|--------|--------|------|--------|----------|------|--------|--------|
| S31- | Eisenstadt Mitte | KN Eisenstadt | 0,42 | 0,0761 | 0,0013 | 0,42 | 0,0761 | 0,0021 | 0,59 | 0,1065 | 0,0031 | 0,60 | 0,1065 | 0,0048 | 0,85 | 0,1217 | 0,0039 | 0,86 | 0,1217 | 0,0061 |
| S31- | KN Eisenstadt | Wulkaprodersdorf | 0,56 | 0,1013 | 0,0018 | 0,57 | 0,1013 | 0,0028 | 0,79 | 0,1418 | 0,0041 | 0,79 | 0,1418 | 0,0064 | 1,14 | 0,1620 | 0,0051 | 1,14 | 0,1620 | 0,0081 |
| S31- | Wulkaprodersdorf | KN Mattersburg | 1,60 | 0,2875 | 0,0050 | 1,61 | 0,2875 | 0,0079 | 2,25 | 0,4025 | 0,0116 | 2,25 | 0,4025 | 0,0182 | 3,22 | 0,4600 | 0,0146 | 3,23 | 0,4600 | 0,0229 |
| S31- | KN Mattersburg | Forchtenstein | 1,16 | 0,2081 | 0,0036 | 1,16 | 0,2081 | 0,0057 | 1,63 | 0,2914 | 0,0084 | 1,63 | 0,2914 | 0,0132 | 2,33 | 0,3330 | 0,0106 | 2,34 | 0,3330 | 0,0166 |
| S31- | Forchtenstein | Sieggraben | 1,62 | 0,2908 | 0,0051 | 1,62 | 0,2908 | 0,0080 | 2,27 | 0,4071 | 0,0117 | 2,28 | 0,4071 | 0,0184 | 3,26 | 0,4653 | 0,0148 | 3,27 | 0,4653 | 0,0232 |
| S31- | Sieggraben | Weppersdorf/Kobersdorf | 1,95 | 0,3503 | 0,0061 | 1,96 | 0,3503 | 0,0096 | 2,74 | 0,4904 | 0,0141 | 2,75 | 0,4904 | 0,0222 | 3,93 | 0,5605 | 0,0178 | 3,94 | 0,5605 | 0,0279 |
| S31- | Weppersdorf/Kobersdorf | Weppersdorf/Markt St.Martin | 0,40 | 0,0720 | 0,0013 | 0,40 | 0,0720 | 0,0020 | 0,56 | 0,1007 | 0,0029 | 0,56 | 0,1007 | 0,0046 | 0,81 | 0,1151 | 0,0037 | 0,81 | 0,1151 | 0,0057 |
| S31- | Weppersdorf/Markt St.Martin | Neutal | 0,93 | 0,1663 | 0,0029 | 0,93 | 0,1663 | 0,0046 | 1,30 | 0,2328 | 0,0067 | 1,30 | 0,2328 | 0,0105 | 1,87 | 0,2660 | 0,0084 | 1,87 | 0,2660 | 0,0133 |
| S31- | Neutal | Stoob Süd | 0,81 | 0,1453 | 0,0025 | 0,81 | 0,1453 | 0,0040 | 1,14 | 0,2034 | 0,0058 | 1,14 | 0,2034 | 0,0092 | 1,63 | 0,2324 | 0,0074 | 1,63 | 0,2324 | 0,0116 |
| S31- | Stoob Süd | Oberpullendorf | 0,88 | 0,1586 | 0,0028 | 0,89 | 0,1586 | 0,0044 | 1,24 | 0,2220 | 0,0064 | 1,24 | 0,2220 | 0,0100 | 1,78 | 0,2538 | 0,0080 | 1,78 | 0,2538 | 0,0126 |
| S33- | KN St. Pölten | St. Pölten Ost | 0,48 | 0,0861 | 0,0015 | 0,48 | 0,0861 | 0,0024 | 0,67 | 0,1205 | 0,0035 | 0,67 | 0,1205 | 0,0054 | 0,97 | 0,1377 | 0,0044 | 0,97 | 0,1377 | 0,0069 |
| S33- | St. Pölten Ost | St. Pölten Nord | 0,85 | 0,1521 | 0,0027 | 0,85 | 0,1521 | 0,0042 | 1,19 | 0,2130 | 0,0061 | 1,19 | 0,2130 | 0,0096 | 1,71 | 0,2434 | 0,0077 | 1,71 | 0,2434 | 0,0121 |
| S33- | St. Pölten Nord | Herzogenburg Süd | 0,90 | 0,1611 | 0,0028 | 0,90 | 0,1611 | 0,0044 | 1,26 | 0,2255 | 0,0065 | 1,26 | 0,2255 | 0,0102 | 1,81 | 0,2577 | 0,0082 | 1,81 | 0,2577 | 0,0128 |
| S33- | Herzogenburg Süd | Herzogenburg Stadt | 0,48 | 0,0860 | 0,0015 | 0,48 | 0,0860 | 0,0024 | 0,67 | 0,1204 | 0,0035 | 0,67 | 0,1204 | 0,0054 | 0,96 | 0,1376 | 0,0044 | 0,97 | 0,1376 | 0,0069 |
| S33- | Herzogenburg Stadt | Herzogenburg Nord | 0,27 | 0,0477 | 0,0008 | 0,27 | 0,0477 | 0,0013 | 0,37 | 0,0668 | 0,0019 | 0,37 | 0,0668 | 0,0030 | 0,53 | 0,0763 | 0,0024 | 0,54 | 0,0763 | 0,0038 |
| S33- | Herzogenburg Nord | Traismauer Süd | 1,29 | 0,2320 | 0,0041 | 1,30 | 0,2320 | 0,0064 | 1,81 | 0,3249 | 0,0093 | 1,82 | 0,3249 | 0,0147 | 2,60 | 0,3713 | 0,0118 | 2,61 | 0,3713 | 0,0185 |
| S33- | Traismauer Süd | Traismauer Nord | 0,66 | 0,1180 | 0,0021 | 0,66 | 0,1180 | 0,0032 | 0,92 | 0,1652 | 0,0047 | 0,93 | 0,1652 | 0,0075 | 1,32 | 0,1888 | 0,0060 | 1,33 | 0,1888 | 0,0094 |
| S33- | Traismauer Nord | Jettsdorf | 1,11 | 0,1993 | 0,0035 | 1,11 | 0,1993 | 0,0055 | 1,56 | 0,2790 | 0,0080 | 1,56 | 0,2790 | 0,0126 | 2,24 | 0,3188 | 0,0101 | 2,24 | 0,3188 | 0,0159 |
| S35- | KN Bruck/Mur | Pernegg | 1,36 | 0,2436 | 0,0043 | 1,36 | 0,2436 | 0,0067 | 1,90 | 0,3410 | 0,0098 | 1,91 | 0,3410 | 0,0154 | 2,73 | 0,3898 | 0,0124 | 2,74 | 0,3898 | 0,0194 |
| S35- | Pernegg | Mixnitz/Mautstatt | 0,99 | 0,1772 | 0,0031 | 0,99 | 0,1772 | 0,0049 | 1,38 | 0,2480 | 0,0071 | 1,39 | 0,2480 | 0,0112 | 1,99 | 0,2835 | 0,0090 | 1,99 | 0,2835 | 0,0141 |
| S35- | Mixnitz/Mautstatt | Röthelstein | 1,18 | 0,2124 | 0,0037 | 1,19 | 0,2124 | 0,0058 | 1,66 | 0,2974 | 0,0085 | 1,67 | 0,2974 | 0,0134 | 2,38 | 0,3398 | 0,0108 | 2,39 | 0,3398 | 0,0169 |
| S35- | Röthelstein | Laufnitzdorf | 0,57 | 0,1024 | 0,0018 | 0,57 | 0,1024 | 0,0028 | 0,80 | 0,1433 | 0,0041 | 0,80 | 0,1433 | 0,0065 | 1,15 | 0,1638 | 0,0052 | 1,15 | 0,1638 | 0,0082 |
| S35- | Laufnitzdorf | Rothleiten | 0,65 | 0,1164 | 0,0020 | 0,65 | 0,1164 | 0,0032 | 0,91 | 0,1629 | 0,0047 | 0,91 | 0,1629 | 0,0074 | 1,31 | 0,1862 | 0,0059 | 1,31 | 0,1862 | 0,0093 |
| S35- | Rothleiten | Frohnleiten Nord | 0,40 | 0,0725 | 0,0013 | 0,40 | 0,0725 | 0,0020 | 0,57 | 0,1015 | 0,0029 | 0,57 | 0,1015 | 0,0046 | 0,81 | 0,1160 | 0,0037 | 0,82 | 0,1160 | 0,0058 |
| S35- | Frohnleiten Nord | Frohnleiten | 0,19 | 0,0334 | 0,0006 | 0,19 | 0,0334 | 0,0009 | 0,26 | 0,0468 | 0,0013 | 0,26 | 0,0468 | 0,0021 | 0,38 | 0,0535 | 0,0017 | 0,38 | 0,0535 | 0,0027 |
| S35- | Frohnleiten | Badl Peggau | 1,25 | 0,2248 | 0,0039 | 1,26 | 0,2248 | 0,0062 | 1,76 | 0,3147 | 0,0090 | 1,76 | 0,3147 | 0,0142 | 2,52 | 0,3597 | 0,0114 | 2,53 | 0,3597 | 0,0179 |
| S35- | Badl Peggau | Peggau Mitte | 0,42 | 0,0752 | 0,0013 | 0,42 | 0,0752 | 0,0021 | 0,59 | 0,1053 | 0,0030 | 0,59 | 0,1053 | 0,0048 | 0,84 | 0,1203 | 0,0038 | 0,85 | 0,1203 | 0,0060 |
| S35- | Peggau Mitte | KN Peggau Deutschfeistritz | 0,87 | 0,1566 | 0,0027 | 0,87 | 0,1566 | 0,0043 | 1,22 | 0,2192 | 0,0063 | 1,23 | 0,2192 | 0,0099 | 1,76 | 0,2506 | 0,0079 | 1,76 | 0,2506 | 0,0125 |
| S36- | KN St. Michael | St. Stefan ob Leoben | 0,72 | 0,1290 | 0,0023 | 0,72 | 0,1290 | 0,0035 | 1,01 | 0,1806 | 0,0052 | 1,01 | 0,1806 | 0,0082 | 1,45 | 0,2064 | 0,0065 | 1,45 | 0,2064 | 0,0103 |
| S36- | St. Stefan ob Leoben | Kraubath | 0,77 | 0,1386 | 0,0024 | 0,77 | 0,1386 | 0,0038 | 1,08 | 0,1940 | 0,0056 | 1,09 | 0,1940 | 0,0088 | 1,55 | 0,2218 | 0,0070 | 1,56 | 0,2218 | 0,0111 |
| S36- | Kraubath | Feistritz St. Lorenzen | 1,36 | 0,2435 | 0,0043 | 1,36 | 0,2435 | 0,0067 | 1,90 | 0,3409 | 0,0098 | 1,91 | 0,3409 | 0,0154 | 2,73 | 0,3896 | 0,0124 | 2,74 | 0,3896 | 0,0194 |
| S36- | Feistritz St. Lorenzen | Knittelfeld Ost | 1,56 | 0,2795 | 0,0049 | 1,56 | 0,2795 | 0,0077 | 2,18 | 0,3913 | 0,0112 | 2,19 | 0,3913 | 0,0177 | 3,13 | 0,4472 | 0,0142 | 3,14 | 0,4472 | 0,0223 |
| S36- | Knittelfeld Ost | Knittelfeld West | 0,66 | 0,1185 | 0,0021 | 0,66 | 0,1185 | 0,0033 | 0,93 | 0,1659 | 0,0048 | 0,93 | 0,1659 | 0,0075 | 1,33 | 0,1896 | 0,0060 | 1,33 | 0,1896 | 0,0095 |
| S36- | Knittelfeld West | Zeitweg Ost Spielberg | 0,21 | 0,0370 | 0,0006 | 0,21 | 0,0370 | 0,0010 | 0,29 | 0,0518 | 0,0015 | 0,29 | 0,0518 | 0,0023 | 0,42 | 0,0592 | 0,0019 | 0,42 | 0,0592 | 0,0030 |
| S36- | Zeitweg Ost Spielberg | Zeitweg West | 1,34 | 0,2408 | 0,0042 | 1,34 | 0,2408 | 0,0066 | 1,88 | 0,3371 | 0,0097 | 1,89 | 0,3371 | 0,0152 | 2,70 | 0,3853 | 0,0122 | 2,71 | 0,3853 | 0,0192 |
| S36- | Zeitweg West | Judenburg Ost Fohnsdorf | 0,67 | 0,1211 | 0,0021 | 0,68 | 0,1211 | 0,0033 | 0,95 | 0,1695 | 0,0049 | 0,95 | 0,1695 | 0,0077 | 1,36 | 0,1937 | 0,0061 | 1,36 | 0,1937 | 0,0097 |
| S36- | Judenburg Ost Fohnsdorf | Judenburg West | 1,05 | 0,1878 | 0,0033 | 1,05 | 0,1878 | 0,0052 | 1,47 | 0,2630 | 0,0076 | 1,47 | 0,2630 | 0,0119 | 2,11 | 0,3005 | 0,0095 | 2,11 | 0,3005 | 0,0150 |
| S36- | As B317 (prov.) | St. Georgen Ost | 0,11 | 0,0196 | 0,0003 | 0,11 | 0,0196 | 0,0005 | 0,15 | 0,0275 | 0,0008 | 0,15 | 0,0275 | 0,0012 | 0,22 | 0,0314 | 0,0010 | 0,22 | 0,0314 | 0,0016 |
| S36- | St. Georgen Ost | St. Georgen West | 0,20 | 0,0364 | 0,0006 | 0,20 | 0,0364 | 0,0010 | 0,28 | 0,0509 | 0,0015 | 0,29 | 0,0509 | 0,0023 | 0,41 | 0,0582 | 0,0018 | 0,41 | 0,0582 | 0,0029 |
| S37- | St. Veit Nord | St. Veit Mitte / Brückl | 0,63 | 0,1139 | 0,0020 | 0,64 | 0,1139 | 0,0031 | 0,89 | 0,1595 | 0,0046 | 0,89 | 0,1595 | 0,0072 | 1,28 | 0,1823 | 0,0058 | 1,28 | 0,1823 | 0,0091 |
| S37- | St. Veit Mitte / Brückl | St. Veit Süd | 0,54 | 0,0968 | 0,0017 | 0,54 | 0,0968 | 0,0027 | 0,76 | 0,1356 | 0,0039 | 0,76 | 0,1356 | 0,0061 | 1,09 | 0,1549 | 0,0049 | 1,09 | 0,1549 | 0,0077 |
| S37- | St. Veit Süd | St. Veit Industriegebiet | 0,41 | 0,0728 | 0,0013 | 0,41 | 0,0728 | 0,0020 | 0,57 | 0,1019 | 0,0029 | 0,57 | 0,1019 | 0,0046 | 0,82 | 0,1165 | 0,0037 | 0,82 | 0,1165 | 0,0058 |
| S37- | St. Veit Industriegebiet | Maria Saal | 1,42 | 0,2555 | 0,0045 | 1,43 | 0,2555 | 0,0070 | 2,00 | 0,3577 | 0,0103 | 2,00 | 0,3577 | 0,0162 | 2,87 | 0,4088 | 0,0130 | 2,87 | 0,4088 | 0,0204 |
| S37- | Maria Saal | Karnburg | 0,51 | 0,0912 | 0,0016 | 0,51 | 0,0912 | 0,0025 | 0,71 | 0,1277 | 0,0037 | 0,72 | 0,1277 | 0,0058 | 1,02 | 0,1460 | 0,0046 | 1,03 | 0,1460 | 0,0073 |
| S37- | Karnburg | Klagenfurt Nord | 0,44 | 0,0796 | 0,0014 | 0,44 | 0,0796 | 0,0022 | 0,62 | 0,1115 | 0,0032 | 0,62 | 0,1115 | 0,0050 | 0,89 | 0,1274 | 0,0040 | 0,90 | 0,1274 | 0,0064 |
| A01- | Preßbaum | Wien Auhof | 3,11 | 0,5572 | 0,0098 | 3,11 | 0,5572 | 0,0153 | 4,36 | 0,7801 | 0,0224 | 4,37 | 0,7801 | 0,0352 | 6,25 | 0,8915 | 0,0283 | 6,27 | 0,8915 | 0,0444 |
| A01- | KN Steinhäusl | Preßbaum | 1,75 | 0,3149 | 0,0055 | 1,76 | 0,3149 | 0,0087 | 2,46 | 0,4408 | 0,0127 | 2,47 | 0,4408 | 0,0199 | 3,53 | 0,5038 | 0,0160 | 3,54 | 0,5038 | 0,0251 |
| A01- | Alltlengbach | KN Steinhäusl | 1,03 | 0,1851 | 0,0032 | 1,03 | 0,1851 | 0,0051 | 1,45 | 0,2592 | 0,0075 | 1,45 | 0,2592 | 0,0117 | 2,08 | 0,2962 | 0,0094 | 2,08 | 0,2962 | 0,0148 |
| A01- | St. Christophen | Alltlengbach | 1,23 | 0,2208 | 0,0039 | 1,23 | 0,2208 | 0,0061 | 1,73 | 0,3091 | 0,0089 | 1,73 | 0,3091 | 0,0140 | 2,48 | 0,3532 | 0,0112 | 2,48 | 0,3532 | 0,0176 |
| A01- | Böheimkirchen | St. Christophen | 1,48 | 0,2648 | 0,0046 | 1,48 | 0,2648 | 0,0073 | 2,07 | 0,3707 | 0,0107 | 2,08 | 0,3707 | 0,0167 | 2,97 | 0,4236 | 0,0134 | 2,98 | 0,4236 | 0,0211 |
| A01- | KN St. Pölten | Böheimkirchen | 1,44 | 0,2590 | 0,0045 | 1,45 | 0,2590 | 0,0071 | 2,02 | 0,3626 | 0,0104 | 2,03 | 0,3626 | 0,0164 | 2,91 | 0,4144 | 0,0131</ | | | |

| | | | | | | | | | | | | | | | | | | | | |
|------|----------------------------|----------------------------|------|--------|--------|------|--------|--------|------|--------|--------|------|--------|--------|------|--------|--------|------|--------|--------|
| A01- | Laakirchen West | Laakirchen Ost | 0,81 | 0,1448 | 0,0025 | 0,81 | 0,1448 | 0,0040 | 1,13 | 0,2027 | 0,0058 | 1,14 | 0,2027 | 0,0092 | 1,62 | 0,2317 | 0,0073 | 1,63 | 0,2317 | 0,0115 |
| A01- | Regau | Laakirchen West | 1,58 | 0,2838 | 0,0050 | 1,58 | 0,2838 | 0,0078 | 2,22 | 0,3974 | 0,0114 | 2,23 | 0,3974 | 0,0180 | 3,18 | 0,4541 | 0,0144 | 3,19 | 0,4541 | 0,0226 |
| A01- | Schörfling | Regau | 2,08 | 0,3730 | 0,0065 | 2,08 | 0,3730 | 0,0103 | 2,92 | 0,5221 | 0,0150 | 2,92 | 0,5221 | 0,0236 | 4,18 | 0,5967 | 0,0189 | 4,19 | 0,5967 | 0,0297 |
| A01- | Seewalchen | Schörfling | 0,32 | 0,0578 | 0,0010 | 0,32 | 0,0578 | 0,0016 | 0,45 | 0,0809 | 0,0023 | 0,45 | 0,0809 | 0,0037 | 0,65 | 0,0925 | 0,0029 | 0,65 | 0,0925 | 0,0046 |
| A01- | St. Georgen | Seewalchen | 1,88 | 0,3381 | 0,0059 | 1,89 | 0,3381 | 0,0093 | 2,64 | 0,4733 | 0,0136 | 2,65 | 0,4733 | 0,0214 | 3,79 | 0,5409 | 0,0172 | 3,80 | 0,5409 | 0,0270 |
| A01- | Oberwang | St. Georgen | 2,51 | 0,4508 | 0,0079 | 2,52 | 0,4508 | 0,0124 | 3,52 | 0,6311 | 0,0181 | 3,53 | 0,6311 | 0,0285 | 5,06 | 0,7213 | 0,0229 | 5,07 | 0,7213 | 0,0360 |
| A01- | Mondsee | Oberwang | 2,31 | 0,4149 | 0,0073 | 2,32 | 0,4149 | 0,0114 | 3,24 | 0,5809 | 0,0167 | 3,25 | 0,5809 | 0,0262 | 4,65 | 0,6639 | 0,0211 | 4,67 | 0,6639 | 0,0331 |
| A01- | Thalgau | Mondsee | 2,13 | 0,3825 | 0,0067 | 2,14 | 0,3825 | 0,0105 | 2,99 | 0,5355 | 0,0154 | 3,00 | 0,5355 | 0,0242 | 4,29 | 0,6120 | 0,0194 | 4,30 | 0,6120 | 0,0305 |
| A01- | Wallersee | Thalgau | 1,62 | 0,2915 | 0,0051 | 1,63 | 0,2915 | 0,0080 | 2,28 | 0,4081 | 0,0117 | 2,29 | 0,4081 | 0,0184 | 3,27 | 0,4664 | 0,0148 | 3,28 | 0,4664 | 0,0232 |
| A01- | Salzburg Nord | Wallersee | 1,57 | 0,2822 | 0,0049 | 1,58 | 0,2822 | 0,0078 | 2,21 | 0,3950 | 0,0114 | 2,21 | 0,3950 | 0,0178 | 3,16 | 0,4515 | 0,0143 | 3,17 | 0,4515 | 0,0225 |
| A01- | Salzburg Bergheim-West | Salzburg Nord | 0,35 | 0,0636 | 0,0011 | 0,36 | 0,0636 | 0,0017 | 0,50 | 0,0890 | 0,0026 | 0,50 | 0,0890 | 0,0040 | 0,71 | 0,1018 | 0,0032 | 0,72 | 0,1018 | 0,0051 |
| A01- | Messe | Salzburg Bergheim-West | 0,17 | 0,0304 | 0,0005 | 0,17 | 0,0304 | 0,0008 | 0,24 | 0,0426 | 0,0012 | 0,24 | 0,0426 | 0,0019 | 0,34 | 0,0487 | 0,0015 | 0,34 | 0,0487 | 0,0024 |
| A01- | Salzburg Mitte Freilassing | Messe | 0,23 | 0,0405 | 0,0007 | 0,23 | 0,0405 | 0,0011 | 0,32 | 0,0567 | 0,0016 | 0,32 | 0,0567 | 0,0026 | 0,45 | 0,0648 | 0,0021 | 0,46 | 0,0648 | 0,0032 |
| A01- | Kleßheim | Salzburg Mitte Freilassing | 0,28 | 0,0497 | 0,0009 | 0,28 | 0,0497 | 0,0014 | 0,39 | 0,0696 | 0,0020 | 0,39 | 0,0696 | 0,0031 | 0,56 | 0,0796 | 0,0025 | 0,56 | 0,0796 | 0,0040 |
| A01- | Siezenheim | Kleßheim | 0,38 | 0,0689 | 0,0012 | 0,38 | 0,0689 | 0,0019 | 0,54 | 0,0965 | 0,0028 | 0,54 | 0,0965 | 0,0044 | 0,77 | 0,1103 | 0,0035 | 0,78 | 0,1103 | 0,0055 |
| A01- | Flughafen | Siezenheim | 0,19 | 0,0346 | 0,0006 | 0,19 | 0,0346 | 0,0010 | 0,27 | 0,0485 | 0,0014 | 0,27 | 0,0485 | 0,0022 | 0,39 | 0,0554 | 0,0018 | 0,39 | 0,0554 | 0,0028 |
| A01- | Wals Salzburg West | Flughafen | 0,24 | 0,0424 | 0,0007 | 0,24 | 0,0424 | 0,0012 | 0,33 | 0,0593 | 0,0017 | 0,33 | 0,0593 | 0,0027 | 0,48 | 0,0678 | 0,0021 | 0,48 | 0,0678 | 0,0034 |
| A01- | KN Salzburg | Wals Salzburg West | 0,35 | 0,0634 | 0,0011 | 0,35 | 0,0634 | 0,0017 | 0,50 | 0,0888 | 0,0026 | 0,50 | 0,0888 | 0,0040 | 0,71 | 0,1014 | 0,0032 | 0,71 | 0,1014 | 0,0051 |
| A01- | Staatsgrenze Walsberg | KN Salzburg | 0,60 | 0,1077 | 0,0019 | 0,60 | 0,1077 | 0,0030 | 0,84 | 0,1508 | 0,0043 | 0,84 | 0,1508 | 0,0068 | 1,21 | 0,1724 | 0,0055 | 1,21 | 0,1724 | 0,0086 |
| A02- | KN Vösendorf | KN Wien Inzersdorf | 0,75 | 0,1348 | 0,0024 | 0,75 | 0,1348 | 0,0037 | 1,05 | 0,1887 | 0,0054 | 1,06 | 0,1887 | 0,0085 | 1,51 | 0,2157 | 0,0068 | 1,52 | 0,2157 | 0,0108 |
| A02- | Mödling | KN Vösendorf | 0,51 | 0,0916 | 0,0016 | 0,51 | 0,0916 | 0,0025 | 0,72 | 0,1283 | 0,0037 | 0,72 | 0,1283 | 0,0058 | 1,03 | 0,1466 | 0,0047 | 1,03 | 0,1466 | 0,0073 |
| A02- | Wr. Neudorf | Mödling | 0,49 | 0,0874 | 0,0015 | 0,49 | 0,0874 | 0,0024 | 0,68 | 0,1224 | 0,0035 | 0,69 | 0,1224 | 0,0055 | 0,98 | 0,1399 | 0,0044 | 0,98 | 0,1399 | 0,0070 |
| A02- | Wr. Neudorf IZ/Süd | Wr. Neudorf | 0,54 | 0,0962 | 0,0017 | 0,54 | 0,0962 | 0,0026 | 0,75 | 0,1347 | 0,0039 | 0,75 | 0,1347 | 0,0061 | 1,08 | 0,1539 | 0,0049 | 1,08 | 0,1539 | 0,0077 |
| A02- | KN Guntramsdorf | Wr. Neudorf IZ/Süd | 0,78 | 0,1402 | 0,0025 | 0,78 | 0,1402 | 0,0039 | 1,10 | 0,1963 | 0,0056 | 1,10 | 0,1963 | 0,0089 | 1,57 | 0,2244 | 0,0071 | 1,58 | 0,2244 | 0,0112 |
| A02- | Traiskirchen | KN Guntramsdorf | 0,87 | 0,1562 | 0,0027 | 0,87 | 0,1562 | 0,0043 | 1,22 | 0,2186 | 0,0063 | 1,22 | 0,2186 | 0,0099 | 1,75 | 0,2499 | 0,0079 | 1,76 | 0,2499 | 0,0125 |
| A02- | Baden | Traiskirchen | 0,48 | 0,0869 | 0,0015 | 0,49 | 0,0869 | 0,0024 | 0,68 | 0,1217 | 0,0035 | 0,68 | 0,1217 | 0,0055 | 0,97 | 0,1391 | 0,0044 | 0,98 | 0,1391 | 0,0069 |
| A02- | Bad Vöslau | Baden | 0,80 | 0,1428 | 0,0025 | 0,80 | 0,1428 | 0,0039 | 1,12 | 0,1999 | 0,0057 | 1,12 | 0,1999 | 0,0090 | 1,60 | 0,2285 | 0,0072 | 1,61 | 0,2285 | 0,0114 |
| A02- | Kottingbrunn | Bad Vöslau | 0,57 | 0,1031 | 0,0018 | 0,58 | 0,1031 | 0,0028 | 0,81 | 0,1444 | 0,0042 | 0,81 | 0,1444 | 0,0065 | 1,16 | 0,1650 | 0,0052 | 1,16 | 0,1650 | 0,0082 |
| A02- | Leobersdorf | Kottingbrunn | 0,50 | 0,0905 | 0,0016 | 0,51 | 0,0905 | 0,0025 | 0,71 | 0,1267 | 0,0036 | 0,71 | 0,1267 | 0,0057 | 1,01 | 0,1448 | 0,0046 | 1,02 | 0,1448 | 0,0072 |
| A02- | Wöllersdorf | Leobersdorf | 2,01 | 0,3610 | 0,0063 | 2,02 | 0,3610 | 0,0099 | 2,82 | 0,5054 | 0,0145 | 2,83 | 0,5054 | 0,0228 | 4,05 | 0,5776 | 0,0183 | 4,06 | 0,5776 | 0,0288 |
| A02- | Wr. Neustadt West | Wöllersdorf | 1,31 | 0,2345 | 0,0041 | 1,31 | 0,2345 | 0,0064 | 1,83 | 0,3283 | 0,0094 | 1,84 | 0,3283 | 0,0148 | 2,63 | 0,3752 | 0,0119 | 2,64 | 0,3752 | 0,0187 |
| A02- | KN Wr. Neustadt | Wr. Neustadt West | 0,52 | 0,0939 | 0,0016 | 0,52 | 0,0939 | 0,0026 | 0,73 | 0,1314 | 0,0038 | 0,74 | 0,1314 | 0,0059 | 1,05 | 0,1502 | 0,0048 | 1,06 | 0,1502 | 0,0075 |
| A02- | KN Seebenstein | KN Wr. Neustadt | 2,37 | 0,4248 | 0,0074 | 2,37 | 0,4248 | 0,0117 | 3,32 | 0,5947 | 0,0171 | 3,33 | 0,5947 | 0,0269 | 4,76 | 0,6797 | 0,0216 | 4,78 | 0,6797 | 0,0339 |
| A02- | Grimmenstein | KN Seebenstein | 2,02 | 0,3624 | 0,0063 | 2,02 | 0,3624 | 0,0100 | 2,83 | 0,5073 | 0,0146 | 2,84 | 0,5073 | 0,0229 | 4,06 | 0,5798 | 0,0184 | 4,07 | 0,5798 | 0,0289 |
| A02- | Edlitz | Grimmenstein | 0,56 | 0,1003 | 0,0018 | 0,56 | 0,1003 | 0,0028 | 0,78 | 0,1404 | 0,0040 | 0,79 | 0,1404 | 0,0063 | 1,13 | 0,1605 | 0,0051 | 1,13 | 0,1605 | 0,0080 |
| A02- | Krumbach | Edlitz | 1,73 | 0,3098 | 0,0054 | 1,73 | 0,3098 | 0,0085 | 2,42 | 0,4337 | 0,0125 | 2,43 | 0,4337 | 0,0196 | 3,47 | 0,4957 | 0,0157 | 3,48 | 0,4957 | 0,0247 |
| A02- | Zöbern | Krumbach | 0,91 | 0,1635 | 0,0029 | 0,91 | 0,1635 | 0,0045 | 1,28 | 0,2289 | 0,0066 | 1,28 | 0,2289 | 0,0103 | 1,83 | 0,2616 | 0,0083 | 1,84 | 0,2616 | 0,0130 |
| A02- | Aspang | Zöbern | 0,12 | 0,0214 | 0,0004 | 0,12 | 0,0214 | 0,0006 | 0,17 | 0,0299 | 0,0009 | 0,17 | 0,0299 | 0,0014 | 0,24 | 0,0342 | 0,0011 | 0,24 | 0,0342 | 0,0017 |
| A02- | Schäftern | Aspang | 1,44 | 0,2588 | 0,0045 | 1,44 | 0,2588 | 0,0071 | 2,02 | 0,3623 | 0,0104 | 2,03 | 0,3623 | 0,0164 | 2,90 | 0,4140 | 0,0131 | 2,91 | 0,4140 | 0,0206 |
| A02- | Pinggau/Friedberg | Schäftern | 1,72 | 0,3091 | 0,0054 | 1,73 | 0,3091 | 0,0085 | 2,42 | 0,4327 | 0,0124 | 2,42 | 0,4327 | 0,0195 | 3,47 | 0,4945 | 0,0157 | 3,48 | 0,4945 | 0,0246 |
| A02- | Pinkafeld | Pinggau/Friedberg | 1,17 | 0,2094 | 0,0037 | 1,17 | 0,2094 | 0,0058 | 1,64 | 0,2931 | 0,0084 | 1,64 | 0,2931 | 0,0132 | 2,35 | 0,3350 | 0,0106 | 2,35 | 0,3350 | 0,0167 |
| A02- | Lafnitzal/Oberwart | Pinkafeld | 2,43 | 0,4364 | 0,0076 | 2,44 | 0,4364 | 0,0120 | 3,41 | 0,6110 | 0,0176 | 3,42 | 0,6110 | 0,0276 | 4,90 | 0,6983 | 0,0221 | 4,91 | 0,6983 | 0,0348 |
| A02- | Hartberg | Lafnitzal/Oberwart | 0,96 | 0,1723 | 0,0030 | 0,96 | 0,1723 | 0,0047 | 1,35 | 0,2412 | 0,0069 | 1,35 | 0,2412 | 0,0109 | 1,93 | 0,2756 | 0,0087 | 1,94 | 0,2756 | 0,0137 |
| A02- | Sebersdorf/Bad Waltersdorf | Hartberg | 2,43 | 0,4359 | 0,0076 | 2,43 | 0,4359 | 0,0120 | 3,41 | 0,6103 | 0,0175 | 3,42 | 0,6103 | 0,0276 | 4,89 | 0,6975 | 0,0221 | 4,90 | 0,6975 | 0,0348 |
| A02- | Ilz Fürstenfeld | Sebersdorf/Bad Waltersdorf | 2,72 | 0,4888 | 0,0086 | 2,73 | 0,4888 | 0,0134 | 3,82 | 0,6843 | 0,0197 | 3,83 | 0,6843 | 0,0309 | 5,48 | 0,7820 | 0,0248 | 5,50 | 0,7820 | 0,0390 |
| A02- | Sinabelkirchen | Ilz Fürstenfeld | 2,50 | 0,4493 | 0,0079 | 2,51 | 0,4493 | 0,0124 | 3,51 | 0,6290 | 0,0181 | 3,52 | 0,6290 | 0,0284 | 5,04 | 0,7189 | 0,0228 | 5,05 | 0,7189 | 0,0358 |
| A02- | Gleisdorf Süd | Sinabelkirchen | 1,65 | 0,2960 | 0,0052 | 1,65 | 0,2960 | 0,0081 | 2,31 | 0,4144 | 0,0119 | 2,32 | 0,4144 | 0,0187 | 3,32 | 0,4736 | 0,0150 | 3,33 | 0,4736 | 0,0236 |
| A02- | Gleisdorf West | Gleisdorf Süd | 0,72 | 0,1285 | 0,0022 | 0,72 | 0,1285 | 0,0035 | 1,00 | 0,1799 | 0,0052 | 1,01 | 0,1799 | 0,0081 | 1,44 | 0,2056 | 0,0065 | 1,44 | 0,2056 | 0,0102 |
| A02- | Laßnitzhöhe | Gleisdorf West | 1,88 | 0,3366 | 0,0059 | 1,88 | 0,3366 | 0,0093 | 2,63 | 0,4713 | 0,0135 | 2,64 | 0,4713 | 0,0213 | 3,78 | 0,5386 | 0,0171 | 3,79 | 0,5386 | 0,0268 |
| A02- | KN Graz Ost | Laßnitzhöhe | 2,35 | 0,4212 | 0,0074 | 2,35 | 0,4212 | 0,0116 | 3,29 | 0,5896 | 0,0170 | 3,30 | 0,5896 | 0,0266 | 4,72 | 0,6739 | 0,0214 | 4,74 | 0,6739 | 0,0336 |
| A02- | Graz Feldkirchen Flughafen | KN Graz Ost | 0,84 | 0,1515 | 0,0027 | 0,85 | 0,1515 | 0,0042 | 1,18 | 0,2121 | 0,0061 | 1,19 | 0,2121 | 0,0096 | 1,70 | 0,2424 | 0,0077 | 1,70 | 0,2424 | 0,0121 |
| A02- | KN Graz West | Graz Feldkirchen Flughafen | 0,57 | 0,1014 | 0,0018 | 0,57 | 0,1014 | 0,0028 | 0,79 | 0,1420 | 0,0041 | 0,80 | 0,1420 | 0,0064 | 1,14 | 0,1623 | 0,0051 | 1,14 | 0,1623 | 0,0081 |
| A02- | Unterpremstätten | KN Graz West | 0,68 | 0,1220 | 0,0021 | 0,68 | 0,1220 | 0,0034 | 0,95 | 0,1707 | 0,0049 | 0,96 | 0,1707 | 0,0077 | 1,37 | 0,1951 | 0,0062 | 1,37 | 0,1951 | 0,0097 |
| A02- | Lieboch | Unterpremstätten | 1,06 | 0,1894 | 0,0033 | 1,06 | 0,1894 | 0,0052 | 1,48 | 0,2652 | 0,0076 | 1,49 | 0,2652 | 0,0120 | 2,12 | 0,3030 | 0,0096 | 2,13 | 0,3030 | 0,0151 |
| A02- | Mooskirchen | Lieboch | 1,46 | 0,2612 | 0,0046 | 1,46 | 0,2612 | 0,0072 | 2,04 | 0,3656 | 0,0105 | 2,05 | 0,3656 | 0,0165 | 2,93 | 0,4179 | 0,0133 | 2,94 | 0,4179 | 0,0208 |
| A02- | Steinberg | Mooskirchen | 1,51 | 0,2703 | 0,0047 | 1,51 | 0,2703 | 0,0074 | 2,11 | 0,3784 | 0,0109 | 2,12 | 0,3784 | 0,0171 | 3,03 | 0,4324 | 0,0137 | 3,04 | 0,4324 | 0,0216 |
| A02- | Modriach | Steinberg | 3,76 | 0,6756 | 0,0118 | 3,77 | 0,6756 | 0,0186 | 5,28 | 0,9458 | 0,0272 | 5,30 | | | | | | | | |

| | | | | | | | | | | | | | | | | | | | | |
|------|----------------------------------|----------------------------------|------|--------|--------|------|----------|--------|------|--------|--------|------|--------|--------|------|--------|--------|------|--------|--------|
| A02- | Velden West | Velden Ost | 0,83 | 0,1493 | 0,0026 | 0,83 | 0,1493 | 0,0041 | 1,17 | 0,2090 | 0,0060 | 1,17 | 0,2090 | 0,0094 | 1,67 | 0,2389 | 0,0076 | 1,68 | 0,2389 | 0,0119 |
| A02- | Wernberg | Velden West | 1,38 | 0,2468 | 0,0043 | 1,38 | 0,2468 | 0,0068 | 1,93 | 0,3455 | 0,0099 | 1,93 | 0,3455 | 0,0156 | 2,77 | 0,3949 | 0,0125 | 2,78 | 0,3949 | 0,0197 |
| A02- | KN Villach | Wernberg | 0,73 | 0,1312 | 0,0023 | 0,73 | 0,1312 | 0,0036 | 1,03 | 0,1837 | 0,0053 | 1,03 | 0,1837 | 0,0083 | 1,47 | 0,2099 | 0,0067 | 1,48 | 0,2099 | 0,0105 |
| A02- | Villach Faaker See | KN Villach | 0,57 | 0,1020 | 0,0018 | 0,57 | 0,1020 | 0,0028 | 0,80 | 0,1428 | 0,0041 | 0,80 | 0,1428 | 0,0065 | 1,14 | 0,1632 | 0,0052 | 1,15 | 0,1632 | 0,0081 |
| A02- | Villach Warmbad | Villach Faaker See | 1,30 | 0,2330 | 0,0041 | 1,30 | 0,2330 | 0,0064 | 1,82 | 0,3262 | 0,0094 | 1,83 | 0,3262 | 0,0147 | 2,61 | 0,3728 | 0,0118 | 2,62 | 0,3728 | 0,0186 |
| A02- | Hermagor | Villach Warmbad | 2,35 | 0,4224 | 0,0074 | 2,36 | 0,4224 | 0,0116 | 3,30 | 0,5914 | 0,0170 | 3,31 | 0,5914 | 0,0267 | 4,74 | 0,6758 | 0,0214 | 4,75 | 0,6758 | 0,0337 |
| A02- | Arnoldstein | Hermagor | 0,56 | 0,1006 | 0,0018 | 0,56 | 0,1006 | 0,0028 | 0,79 | 0,1408 | 0,0040 | 0,79 | 0,1408 | 0,0064 | 1,13 | 0,1610 | 0,0051 | 1,13 | 0,1610 | 0,0080 |
| A02- | Staatsgrenze Arnoldstein | Arnoldstein | 0,86 | 0,1542 | 0,0027 | 0,86 | 0,1542 | 0,0042 | 1,21 | 0,2159 | 0,0062 | 1,21 | 0,2159 | 0,0098 | 1,73 | 0,2468 | 0,0078 | 1,73 | 0,2468 | 0,0123 |
| A03- | Münchendorf/Achau | KN Guntramsdorf | 0,22 | 0,0400 | 0,0007 | 0,22 | 0,0400 | 0,0011 | 0,31 | 0,0561 | 0,0016 | 0,31 | 0,0561 | 0,0025 | 0,45 | 0,0641 | 0,0020 | 0,45 | 0,0641 | 0,0032 |
| A03- | Ebreichsdorf Nord | Münchendorf/Achau | 0,94 | 0,1686 | 0,0029 | 0,94 | 0,1686 | 0,0046 | 1,32 | 0,2360 | 0,0068 | 1,32 | 0,2360 | 0,0107 | 1,89 | 0,2697 | 0,0086 | 1,90 | 0,2697 | 0,0134 |
| A03- | Ebreichsdorf West | Ebreichsdorf Nord | 0,77 | 0,1376 | 0,0024 | 0,77 | 0,1376 | 0,0038 | 1,08 | 0,1926 | 0,0055 | 1,08 | 0,1926 | 0,0087 | 1,54 | 0,2202 | 0,0070 | 1,55 | 0,2202 | 0,0110 |
| A03- | Pottendorf | Ebreichsdorf West | 1,01 | 0,1805 | 0,0032 | 1,01 | 0,1805 | 0,0050 | 1,41 | 0,2527 | 0,0073 | 1,42 | 0,2527 | 0,0114 | 2,02 | 0,2888 | 0,0092 | 2,03 | 0,2888 | 0,0144 |
| A03- | Hornstein | Pottendorf | 1,65 | 0,2964 | 0,0052 | 1,65 | 0,2964 | 0,0082 | 2,32 | 0,4150 | 0,0119 | 2,32 | 0,4150 | 0,0187 | 3,32 | 0,4742 | 0,0150 | 3,33 | 0,4742 | 0,0236 |
| A03- | Müllendorf | Hornstein | 1,08 | 0,1942 | 0,0034 | 1,08 | 0,1942 | 0,0053 | 1,52 | 0,2719 | 0,0078 | 1,52 | 0,2719 | 0,0123 | 2,18 | 0,3108 | 0,0099 | 2,18 | 0,3108 | 0,0155 |
| A03- | KN Eisenstadt | Müllendorf | 0,90 | 0,1624 | 0,0028 | 0,91 | 0,1624 | 0,0045 | 1,27 | 0,2273 | 0,0065 | 1,27 | 0,2273 | 0,0103 | 1,82 | 0,2598 | 0,0082 | 1,83 | 0,2598 | 0,0129 |
| A031 | Siegenderf | KN Eisenstadt | 0,71 | 0,1280 | 0,0022 | 0,71 | 0,1280 | 0,0035 | 1,00 | 0,1792 | 0,0052 | 1,00 | 0,1792 | 0,0081 | 1,44 | 0,2048 | 0,0065 | 1,44 | 0,2048 | 0,0102 |
| A041 | KN Wien Prater | Stadionbrücke | 0,13 | 0,0235 | 0,0004 | 0,13 | 0,0235 | 0,0006 | 0,18 | 0,0329 | 0,0009 | 0,18 | 0,0329 | 0,0015 | 0,26 | 0,0376 | 0,0012 | 0,26 | 0,0376 | 0,0019 |
| A04- | Wien Simmeringer Haide | KN Wien Prater | 0,90 | 0,1622 | 0,0028 | 0,91 | 0,1622 | 0,0045 | 1,27 | 0,2271 | 0,0065 | 1,27 | 0,2271 | 0,0103 | 1,82 | 0,2595 | 0,0082 | 1,82 | 0,2595 | 0,0129 |
| A04- | KN Schwechat | Wien Simmeringer Haide | 0,81 | 0,1456 | 0,0025 | 0,81 | 0,1456 | 0,0040 | 1,14 | 0,2038 | 0,0059 | 1,14 | 0,2038 | 0,0092 | 1,63 | 0,2330 | 0,0074 | 1,64 | 0,2330 | 0,0116 |
| A04- | Flughafen Wien Schwechat | KN Schwechat | 1,17 | 0,2103 | 0,0037 | 1,17 | 0,2103 | 0,0058 | 1,64 | 0,2944 | 0,0085 | 1,65 | 0,2944 | 0,0133 | 2,36 | 0,3365 | 0,0107 | 2,37 | 0,3365 | 0,0168 |
| A04- | Fischamend | Flughafen Wien Schwechat | 1,31 | 0,2355 | 0,0041 | 1,31 | 0,2355 | 0,0065 | 1,84 | 0,3297 | 0,0095 | 1,85 | 0,3297 | 0,0149 | 2,64 | 0,3768 | 0,0120 | 2,65 | 0,3768 | 0,0188 |
| A04- | Bruck/Leitha West | Fischamend | 2,88 | 0,5164 | 0,0090 | 2,88 | 0,5164 | 0,0142 | 4,04 | 0,7230 | 0,0208 | 4,05 | 0,7230 | 0,0327 | 5,79 | 0,8263 | 0,0262 | 5,81 | 0,8263 | 0,0412 |
| A04- | Bruck/Leitha Ost | Bruck/Leitha West | 0,96 | 0,1715 | 0,0030 | 0,96 | 0,1715 | 0,0047 | 1,34 | 0,2401 | 0,0069 | 1,34 | 0,2401 | 0,0108 | 1,92 | 0,2744 | 0,0087 | 1,93 | 0,2744 | 0,0137 |
| A04- | KN Bruckneudorf | Bruck/Leitha Ost | 0,60 | 0,1070 | 0,0019 | 0,60 | 0,1070 | 0,0029 | 0,84 | 0,1498 | 0,0043 | 0,84 | 0,1498 | 0,0068 | 1,20 | 0,1712 | 0,0054 | 1,20 | 0,1712 | 0,0085 |
| A04- | Parndorf | KN Bruckneudorf | 0,38 | 0,0689 | 0,0012 | 0,38 | 0,0689 | 0,0019 | 0,54 | 0,0964 | 0,0028 | 0,54 | 0,0964 | 0,0044 | 0,77 | 0,1102 | 0,0035 | 0,77 | 0,1102 | 0,0055 |
| A04- | Neusiedl | Parndorf | 0,74 | 0,1332 | 0,0023 | 0,74 | 0,1332 | 0,0037 | 1,04 | 0,1865 | 0,0054 | 1,04 | 0,1865 | 0,0084 | 1,49 | 0,2131 | 0,0068 | 1,50 | 0,2131 | 0,0106 |
| A04- | Neusiedl/Gewerbepark | Neusiedl | 0,17 | 0,0309 | 0,0005 | 0,17 | 0,0309 | 0,0008 | 0,24 | 0,0432 | 0,0012 | 0,24 | 0,0432 | 0,0020 | 0,35 | 0,0494 | 0,0016 | 0,35 | 0,0494 | 0,0025 |
| A04- | Weiden/Gols | Neusiedl/Gewerbepark | 1,54 | 0,2762 | 0,0048 | 1,54 | 0,2762 | 0,0076 | 2,16 | 0,3867 | 0,0111 | 2,17 | 0,3867 | 0,0175 | 3,10 | 0,4420 | 0,0140 | 3,11 | 0,4420 | 0,0220 |
| A04- | Mönchhof | Weiden/Gols | 1,12 | 0,2015 | 0,0035 | 1,12 | 0,2015 | 0,0055 | 1,58 | 0,2821 | 0,0081 | 1,58 | 0,2821 | 0,0127 | 2,26 | 0,3224 | 0,0102 | 2,27 | 0,3224 | 0,0161 |
| A04- | Nickelsdorf | Mönchhof | 1,76 | 0,3157 | 0,0055 | 1,76 | 0,3157 | 0,0087 | 2,47 | 0,4420 | 0,0127 | 2,48 | 0,4420 | 0,0200 | 3,54 | 0,5052 | 0,0160 | 3,55 | 0,5052 | 0,0252 |
| A04- | Staatsgrenze Nickelsdorf | Nickelsdorf | 0,31 | 0,0559 | 0,0010 | 0,31 | 0,0559 | 0,0015 | 0,44 | 0,0783 | 0,0023 | 0,44 | 0,0783 | 0,0035 | 0,63 | 0,0895 | 0,0028 | 0,63 | 0,0895 | 0,0045 |
| A05- | Wolkersdorf Süd | KN Eibesbrunn | 0,61 | 0,1088 | 0,0019 | 0,61 | 0,1088 | 0,0030 | 0,85 | 0,1524 | 0,0044 | 0,85 | 0,1524 | 0,0069 | 1,22 | 0,1741 | 0,0055 | 1,22 | 0,1741 | 0,0087 |
| A05- | Ulrichskirchen | Wolkersdorf Süd | 0,66 | 0,1177 | 0,0021 | 0,66 | 0,1177 | 0,0032 | 0,92 | 0,1648 | 0,0047 | 0,92 | 0,1648 | 0,0074 | 1,32 | 0,1884 | 0,0060 | 1,32 | 0,1884 | 0,0094 |
| A05- | Wolkersdorf Nord | Ulrichskirchen | 0,43 | 0,0769 | 0,0013 | 0,43 | 0,0769 | 0,0021 | 0,60 | 0,1077 | 0,0031 | 0,60 | 0,1077 | 0,0049 | 0,86 | 0,1231 | 0,0039 | 0,87 | 0,1231 | 0,0061 |
| A05- | Hochleithen | Wolkersdorf Nord | 0,77 | 0,1380 | 0,0024 | 0,77 | 0,1380 | 0,0038 | 1,08 | 0,1932 | 0,0056 | 1,08 | 0,1932 | 0,0087 | 1,55 | 0,2208 | 0,0070 | 1,55 | 0,2208 | 0,0110 |
| A05- | Gaweinstal Mitte | Hochleithen | 1,54 | 0,2761 | 0,0048 | 1,54 | 0,2761 | 0,0076 | 2,16 | 0,3865 | 0,0111 | 2,16 | 0,3865 | 0,0175 | 3,10 | 0,4417 | 0,0140 | 3,10 | 0,4417 | 0,0220 |
| A05- | Gaweinstal Nord | Gaweinstal Mitte | 0,41 | 0,0730 | 0,0013 | 0,41 | 0,0730 | 0,0020 | 0,57 | 0,1023 | 0,0029 | 0,57 | 0,1023 | 0,0046 | 0,82 | 0,1169 | 0,0037 | 0,82 | 0,1169 | 0,0058 |
| A05- | Mistelbach Süd | Gaweinstal Nord | 0,70 | 0,1261 | 0,0022 | 0,70 | 0,1261 | 0,0035 | 0,99 | 0,1765 | 0,0051 | 0,99 | 0,1765 | 0,0080 | 1,41 | 0,2017 | 0,0064 | 1,42 | 0,2017 | 0,0101 |
| A05- | Mistelbach Ost / Wilfersdorf | Mistelbach Süd | 1,18 | 0,2116 | 0,0037 | 1,18 | 0,2116 | 0,0058 | 1,65 | 0,2962 | 0,0085 | 1,66 | 0,2962 | 0,0134 | 2,37 | 0,3386 | 0,0107 | 2,38 | 0,3386 | 0,0169 |
| A05- | Poysdorf Süd | Mistelbach Ost / Wilfersdorf | 1,19 | 0,2137 | 0,0037 | 1,19 | 0,2137 | 0,0059 | 1,67 | 0,2992 | 0,0086 | 1,68 | 0,2992 | 0,0135 | 2,40 | 0,3419 | 0,0108 | 2,40 | 0,3419 | 0,0170 |
| A05- | Großkrut | Poysdorf Süd | 1,57 | 0,2818 | 0,0049 | 1,57 | 0,2818 | 0,0077 | 2,20 | 0,3945 | 0,0113 | 2,21 | 0,3945 | 0,0178 | 3,16 | 0,4509 | 0,0143 | 3,17 | 0,4509 | 0,0225 |
| A05- | Poysdorf Nord | Großkrut | 1,53 | 0,2741 | 0,0048 | 1,53 | 0,2741 | 0,0075 | 2,14 | 0,3838 | 0,0110 | 2,15 | 0,3838 | 0,0173 | 3,07 | 0,4386 | 0,0139 | 3,08 | 0,4386 | 0,0219 |
| A06- | Potzneusiedl | KN Bruckneudorf | 1,94 | 0,3472 | 0,0061 | 1,94 | 0,3472 | 0,0095 | 2,71 | 0,4861 | 0,0140 | 2,72 | 0,4861 | 0,0220 | 3,89 | 0,5556 | 0,0176 | 3,90 | 0,5556 | 0,0277 |
| A06- | Gattendorf | Potzneusiedl | 0,84 | 0,1507 | 0,0026 | 0,84 | 0,1507 | 0,0041 | 1,18 | 0,2110 | 0,0061 | 1,18 | 0,2110 | 0,0095 | 1,69 | 0,2412 | 0,0076 | 1,69 | 0,2412 | 0,0120 |
| A06- | Kittsee | Gattendorf | 1,40 | 0,2521 | 0,0044 | 1,41 | 0,2521 | 0,0069 | 1,97 | 0,3529 | 0,0101 | 1,98 | 0,3529 | 0,0159 | 2,83 | 0,4033 | 0,0128 | 2,83 | 0,4033 | 0,0201 |
| A06- | Staatsgrenze Kittsee | Kittsee | 0,71 | 0,1280 | 0,0022 | 0,71 | 0,1280 | 0,0035 | 1,00 | 0,1793 | 0,0052 | 1,00 | 0,1793 | 0,0081 | 1,44 | 0,2049 | 0,0065 | 1,44 | 0,2049 | 0,0102 |
| A07- | Linz Franzosenhausweg | KN Linz | 0,50 | 0,0903 | 0,0016 | 0,50 | 0,0903 | 0,0025 | 0,71 | 0,1264 | 0,0036 | 0,71 | 0,1264 | 0,0057 | 1,01 | 0,1445 | 0,0046 | 1,02 | 0,1445 | 0,0072 |
| A07- | Linz Salzburger Straße Neue Welt | Linz Franzosenhausweg | 0,44 | 0,0788 | 0,0014 | 0,44 | 0,0788 | 0,0022 | 0,62 | 0,1104 | 0,0032 | 0,62 | 0,1104 | 0,0050 | 0,88 | 0,1261 | 0,0040 | 0,89 | 0,1261 | 0,0063 |
| A07- | Muldenstraße Bindermichl | Linz Salzburger Straße Neue Welt | 0,30 | 0,0547 | 0,0010 | 0,31 | 0,0547 | 0,0015 | 0,43 | 0,0766 | 0,0022 | 0,43 | 0,0766 | 0,0035 | 0,61 | 0,0876 | 0,0028 | 0,62 | 0,0876 | 0,0044 |
| A07- | Leonding Linz Zentrum | Muldenstraße Bindermichl | 0,15 | 0,0266 | 0,0005 | 0,15 | 0,0266 | 0,0007 | 0,21 | 0,0372 | 0,0011 | 0,21 | 0,0372 | 0,0017 | 0,30 | 0,0425 | 0,0013 | 0,30 | 0,0425 | 0,0021 |
| A07- | Linz Wiener Straße | Leonding Linz Zentrum | 0,21 | 0,0374 | 0,0007 | 0,21 | 0,0374 | 0,0010 | 0,29 | 0,0523 | 0,0015 | 0,29 | 0,0523 | 0,0024 | 0,42 | 0,0598 | 0,0019 | 0,42 | 0,0598 | 0,0030 |
| A07- | Linz VOEST | Linz Wiener Straße | 0,19 | 0,0347 | 0,0006 | 0,19 | 0,0347 | 0,0010 | 0,27 | 0,0486 | 0,0014 | 0,27 | 0,0486 | 0,0022 | 0,39 | 0,0556 | 0,0018 | 0,39 | 0,0556 | 0,0028 |
| A07- | Linz Industriezeile | Linz VOEST | 0,15 | 0,0272 | 0,0005 | 0,15 | 0,0272 | 0,0007 | 0,21 | 0,0381 | 0,0011 | 0,21 | 0,0381 | 0,0017 | 0,31 | 0,0436 | 0,0014 | 0,31 | 0,0436 | 0,0022 |
| A07- | Linz Prinz Eugenstraße | Linz Industriezeile | 0,24 | 0,0432 | 0,0008 | 0,24 | 0,0432 | 0,0012 | 0,34 | 0,0605 | 0,0017 | 0,34 | 0,0605 | 0,0027 | 0,49 | 0,0692 | 0,0022 | 0,49 | 0,0692 | 0,0034 |
| A07- | Linz Hafensstraße | Linz Prinz Eugenstraße | 0,45 | 0,0809 | 0,0014 | 0,45 | 0,0809 | 0,0022 | 0,63 | 0,1133 | 0,0033 | 0,63 | 0,1133 | 0,0051 | 0,91 | 0,1295 | 0,0041 | 0,91 | 0,1295 | 0,0065 |
| A07- | Linz Urfahr | Linz Hafensstraße | 0,18 | 0,0318 | 0,0006 | 0,18 | 0,0318 | 0,0009 | 0,25 | 0,0445 | 0,0013 | 0,25 | 0,0445 | 0,0020 | 0,36 | 0,0509 | 0,0016 | 0,36 | 0,0509 | 0,0025 |
| A07- | Linz Dornach | Linz Urfahr | 0,43 | 0,0770 | 0,0013 | 0,43 | 0,0770</ | | | | | | | | | | | | | |

| | | | | | | | | | | | | | | | | | | | | |
|------|---|--------------------------------------|-------|--------|--------|-------|--------|--------|-------|--------|--------|-------|--------|--------|-------|--------|--------|-------|--------|--------|
| A08- | Staatsgrenze Suben | Schürding Suben | 0,50 | 0,0893 | 0,0016 | 0,50 | 0,0893 | 0,0025 | 0,70 | 0,1250 | 0,0036 | 0,70 | 0,1250 | 0,0056 | 1,00 | 0,1428 | 0,0045 | 1,00 | 0,1428 | 0,0071 |
| A09- | Ried im Traunkreis | KN Voralpenkreuz | 1,23 | 0,2200 | 0,0039 | 1,23 | 0,2200 | 0,0061 | 1,72 | 0,3081 | 0,0089 | 1,73 | 0,3081 | 0,0139 | 2,47 | 0,3521 | 0,0112 | 2,47 | 0,3521 | 0,0175 |
| A09- | Inzersdorf Kirchdorf | Ried im Traunkreis | 2,30 | 0,4128 | 0,0072 | 2,30 | 0,4128 | 0,0114 | 3,23 | 0,5779 | 0,0166 | 3,24 | 0,5779 | 0,0261 | 4,63 | 0,6604 | 0,0209 | 4,64 | 0,6604 | 0,0329 |
| A09- | Klaus | Inzersdorf Kirchdorf | 2,80 | 0,5028 | 0,0088 | 2,81 | 0,5028 | 0,0138 | 3,93 | 0,7039 | 0,0202 | 3,94 | 0,7039 | 0,0318 | 5,64 | 0,8045 | 0,0255 | 5,65 | 0,8045 | 0,0401 |
| A09- | St. Pankratz | Klaus | 1,78 | 0,3196 | 0,0056 | 1,78 | 0,3196 | 0,0088 | 2,50 | 0,4474 | 0,0129 | 2,51 | 0,4474 | 0,0202 | 3,58 | 0,5114 | 0,0162 | 3,59 | 0,5114 | 0,0255 |
| A09- | Roßleiten Windischgarsten | St. Pankratz | 2,48 | 0,4459 | 0,0078 | 2,49 | 0,4459 | 0,0123 | 3,49 | 0,6243 | 0,0179 | 3,50 | 0,6243 | 0,0282 | 5,00 | 0,7135 | 0,0226 | 5,01 | 0,7135 | 0,0356 |
| A09- | Gleinkerau | Roßleiten Windischgarsten | 1,17 | 0,2096 | 0,0037 | 1,17 | 0,2096 | 0,0058 | 1,64 | 0,2934 | 0,0084 | 1,64 | 0,2934 | 0,0133 | 2,35 | 0,3354 | 0,0106 | 2,36 | 0,3354 | 0,0167 |
| A09- | Spital am Pyhrn | Gleinkerau | 0,88 | 0,1580 | 0,0028 | 0,88 | 0,1580 | 0,0043 | 1,24 | 0,2212 | 0,0064 | 1,24 | 0,2212 | 0,0100 | 1,77 | 0,2528 | 0,0080 | 1,78 | 0,2528 | 0,0126 |
| A09- | Ardning / Admont | Spital am Pyhrn | 4,53 | 0,4022 | 0,0070 | 4,54 | 0,4022 | 0,0111 | 6,35 | 0,5631 | 0,0162 | 6,36 | 0,5631 | 0,0254 | 9,33 | 0,6436 | 0,0204 | 9,34 | 0,6436 | 0,0321 |
| A09- | Liezen | Ardning / Admont | 0,51 | 0,0917 | 0,0016 | 0,51 | 0,0917 | 0,0025 | 0,72 | 0,1284 | 0,0037 | 0,72 | 0,1284 | 0,0058 | 1,03 | 0,1467 | 0,0047 | 1,03 | 0,1467 | 0,0073 |
| A09- | Rottenmann | Liezen | 1,07 | 0,1916 | 0,0034 | 1,07 | 0,1916 | 0,0053 | 1,50 | 0,2682 | 0,0077 | 1,50 | 0,2682 | 0,0121 | 2,15 | 0,3065 | 0,0097 | 2,15 | 0,3065 | 0,0153 |
| A09- | Trieben | Rottenmann | 2,66 | 0,4776 | 0,0084 | 2,67 | 0,4776 | 0,0131 | 3,73 | 0,6686 | 0,0192 | 3,74 | 0,6686 | 0,0302 | 5,36 | 0,7641 | 0,0242 | 5,37 | 0,7641 | 0,0381 |
| A09- | Treglwang | Trieben | 2,16 | 0,3883 | 0,0068 | 2,17 | 0,3883 | 0,0107 | 3,04 | 0,5436 | 0,0156 | 3,04 | 0,5436 | 0,0246 | 4,36 | 0,6212 | 0,0197 | 4,37 | 0,6212 | 0,0310 |
| A09- | Kalwang | Treglwang | 2,91 | 0,5218 | 0,0091 | 2,91 | 0,5218 | 0,0143 | 4,08 | 0,7305 | 0,0210 | 4,09 | 0,7305 | 0,0330 | 5,85 | 0,8349 | 0,0265 | 5,87 | 0,8349 | 0,0416 |
| A09- | Mautern | Kalwang | 1,35 | 0,2430 | 0,0043 | 1,36 | 0,2430 | 0,0067 | 1,90 | 0,3401 | 0,0098 | 1,90 | 0,3401 | 0,0154 | 2,73 | 0,3887 | 0,0123 | 2,73 | 0,3887 | 0,0194 |
| A09- | Kammern | Mautern | 1,52 | 0,2733 | 0,0048 | 1,53 | 0,2733 | 0,0075 | 2,14 | 0,3826 | 0,0110 | 2,14 | 0,3826 | 0,0173 | 3,07 | 0,4373 | 0,0139 | 3,07 | 0,4373 | 0,0218 |
| A09- | Traboch | Kammern | 1,59 | 0,2858 | 0,0050 | 1,60 | 0,2858 | 0,0079 | 2,23 | 0,4001 | 0,0115 | 2,24 | 0,4001 | 0,0181 | 3,21 | 0,4572 | 0,0145 | 3,21 | 0,4572 | 0,0228 |
| A09- | Terminal St. Michael | Traboch | 0,31 | 0,0561 | 0,0010 | 0,31 | 0,0561 | 0,0015 | 0,44 | 0,0786 | 0,0023 | 0,44 | 0,0786 | 0,0035 | 0,63 | 0,0898 | 0,0028 | 0,63 | 0,0898 | 0,0045 |
| A09- | KN St. Michael | Terminal St. Michael | 0,59 | 0,1052 | 0,0018 | 0,59 | 0,1052 | 0,0029 | 0,82 | 0,1473 | 0,0042 | 0,82 | 0,1473 | 0,0067 | 1,18 | 0,1683 | 0,0053 | 1,18 | 0,1683 | 0,0084 |
| A09- | Übelbach | KN St. Michael | 11,04 | 0,9797 | 0,0171 | 11,05 | 0,9797 | 0,0269 | 15,48 | 1,3716 | 0,0394 | 15,50 | 1,3716 | 0,0620 | 22,72 | 1,5676 | 0,0497 | 22,74 | 1,5676 | 0,0781 |
| A09- | KN Peggau Deutschefeistritz | Übelbach | 1,81 | 0,3240 | 0,0057 | 1,81 | 0,3240 | 0,0089 | 2,53 | 0,4537 | 0,0130 | 2,54 | 0,4537 | 0,0205 | 3,63 | 0,5185 | 0,0164 | 3,64 | 0,5185 | 0,0258 |
| A09- | Gratkorn Nord | KN Peggau Deutschefeistritz | 0,86 | 0,1535 | 0,0027 | 0,86 | 0,1535 | 0,0042 | 1,20 | 0,2149 | 0,0062 | 1,20 | 0,2149 | 0,0097 | 1,72 | 0,2456 | 0,0078 | 1,73 | 0,2456 | 0,0122 |
| A09- | Gratkorn Süd | Gratkorn Nord | 0,94 | 0,1686 | 0,0030 | 0,94 | 0,1686 | 0,0046 | 1,32 | 0,2360 | 0,0068 | 1,32 | 0,2360 | 0,0107 | 1,89 | 0,2698 | 0,0086 | 1,90 | 0,2698 | 0,0134 |
| A09- | Graz Nord | Gratkorn Süd | 0,21 | 0,0374 | 0,0007 | 0,21 | 0,0374 | 0,0010 | 0,29 | 0,0523 | 0,0015 | 0,29 | 0,0523 | 0,0024 | 0,42 | 0,0598 | 0,0019 | 0,42 | 0,0598 | 0,0030 |
| A09- | Graz Webling | Graz Nord | 2,38 | 0,4274 | 0,0075 | 2,39 | 0,4274 | 0,0118 | 3,34 | 0,5983 | 0,0172 | 3,35 | 0,5983 | 0,0270 | 4,79 | 0,6838 | 0,0217 | 4,81 | 0,6838 | 0,0341 |
| A09- | Seiersberg | Graz Webling | 0,63 | 0,1136 | 0,0020 | 0,63 | 0,1136 | 0,0031 | 0,89 | 0,1590 | 0,0046 | 0,89 | 0,1590 | 0,0072 | 1,27 | 0,1818 | 0,0058 | 1,28 | 0,1818 | 0,0091 |
| A09- | KN Graz West | Seiersberg | 0,31 | 0,0556 | 0,0010 | 0,31 | 0,0556 | 0,0015 | 0,43 | 0,0778 | 0,0022 | 0,44 | 0,0778 | 0,0035 | 0,62 | 0,0890 | 0,0028 | 0,63 | 0,0890 | 0,0044 |
| A09- | Schwarzlsee | KN Graz West | 0,31 | 0,0548 | 0,0010 | 0,31 | 0,0548 | 0,0015 | 0,43 | 0,0767 | 0,0022 | 0,43 | 0,0767 | 0,0035 | 0,61 | 0,0877 | 0,0028 | 0,62 | 0,0877 | 0,0044 |
| A09- | Schachenwald / IBC Businesscenter | Schwarzlsee | 0,34 | 0,0613 | 0,0011 | 0,34 | 0,0613 | 0,0017 | 0,48 | 0,0858 | 0,0025 | 0,48 | 0,0858 | 0,0039 | 0,69 | 0,0980 | 0,0031 | 0,69 | 0,0980 | 0,0049 |
| A09- | Kalsdorf | Schachenwald / IBC Businesscenter | 0,35 | 0,0623 | 0,0011 | 0,35 | 0,0623 | 0,0017 | 0,49 | 0,0872 | 0,0025 | 0,49 | 0,0872 | 0,0039 | 0,70 | 0,0997 | 0,0032 | 0,70 | 0,0997 | 0,0050 |
| A09- | Werndorf Terminal | Kalsdorf | 0,87 | 0,1560 | 0,0027 | 0,87 | 0,1560 | 0,0043 | 1,22 | 0,2184 | 0,0063 | 1,22 | 0,2184 | 0,0099 | 1,75 | 0,2496 | 0,0079 | 1,75 | 0,2496 | 0,0124 |
| A09- | Wildon | Werndorf Terminal | 0,97 | 0,1744 | 0,0031 | 0,97 | 0,1744 | 0,0048 | 1,36 | 0,2441 | 0,0070 | 1,37 | 0,2441 | 0,0110 | 1,96 | 0,2790 | 0,0088 | 1,96 | 0,2790 | 0,0139 |
| A09- | Hengsberg | Wildon | 0,47 | 0,0851 | 0,0015 | 0,48 | 0,0851 | 0,0023 | 0,67 | 0,1192 | 0,0034 | 0,67 | 0,1192 | 0,0054 | 0,95 | 0,1362 | 0,0043 | 0,96 | 0,1362 | 0,0068 |
| A09- | Lebring | Hengsberg | 0,84 | 0,1508 | 0,0026 | 0,84 | 0,1508 | 0,0041 | 1,18 | 0,2111 | 0,0061 | 1,18 | 0,2111 | 0,0095 | 1,69 | 0,2413 | 0,0077 | 1,70 | 0,2413 | 0,0120 |
| A09- | Leibnitz | Lebring | 1,45 | 0,2610 | 0,0046 | 1,46 | 0,2610 | 0,0072 | 2,04 | 0,3655 | 0,0105 | 2,05 | 0,3655 | 0,0165 | 2,93 | 0,4177 | 0,0132 | 2,94 | 0,4177 | 0,0208 |
| A09- | Vogau Straß | Leibnitz | 1,78 | 0,3192 | 0,0056 | 1,78 | 0,3192 | 0,0088 | 2,50 | 0,4469 | 0,0128 | 2,50 | 0,4469 | 0,0202 | 3,58 | 0,5108 | 0,0162 | 3,59 | 0,5108 | 0,0255 |
| A09- | Gersdorf | Vogau Straß | 0,86 | 0,1548 | 0,0027 | 0,86 | 0,1548 | 0,0043 | 1,21 | 0,2168 | 0,0062 | 1,21 | 0,2168 | 0,0098 | 1,74 | 0,2477 | 0,0079 | 1,74 | 0,2477 | 0,0123 |
| A09- | Spielfeld | Gersdorf | 0,45 | 0,0816 | 0,0014 | 0,46 | 0,0816 | 0,0022 | 0,64 | 0,1142 | 0,0033 | 0,64 | 0,1142 | 0,0052 | 0,92 | 0,1306 | 0,0041 | 0,92 | 0,1306 | 0,0065 |
| A09- | Staatsgrenze Spielfeld | Spielfeld | 0,41 | 0,0744 | 0,0013 | 0,42 | 0,0744 | 0,0020 | 0,58 | 0,1042 | 0,0030 | 0,58 | 0,1042 | 0,0047 | 0,83 | 0,1190 | 0,0038 | 0,84 | 0,1190 | 0,0059 |
| A10- | Salzburg Süd / Anif | KN Salzburg | 1,68 | 0,3010 | 0,0053 | 1,68 | 0,3010 | 0,0083 | 2,35 | 0,4213 | 0,0121 | 2,36 | 0,4213 | 0,0190 | 3,38 | 0,4815 | 0,0153 | 3,38 | 0,4815 | 0,0240 |
| A10- | Puch Urstein | Salzburg Süd / Anif | 0,57 | 0,1021 | 0,0018 | 0,57 | 0,1021 | 0,0028 | 0,80 | 0,1430 | 0,0041 | 0,80 | 0,1430 | 0,0065 | 1,15 | 0,1634 | 0,0052 | 1,15 | 0,1634 | 0,0081 |
| A10- | Hallein | Puch Urstein | 1,17 | 0,2108 | 0,0037 | 1,18 | 0,2108 | 0,0058 | 1,65 | 0,2952 | 0,0085 | 1,65 | 0,2952 | 0,0133 | 2,36 | 0,3373 | 0,0107 | 2,37 | 0,3373 | 0,0168 |
| A10- | Kuchl | Hallein | 1,30 | 0,2342 | 0,0041 | 1,31 | 0,2342 | 0,0064 | 1,83 | 0,3278 | 0,0094 | 1,84 | 0,3278 | 0,0148 | 2,63 | 0,3747 | 0,0119 | 2,63 | 0,3747 | 0,0187 |
| A10- | Golling / Abtenau | Kuchl | 1,31 | 0,2354 | 0,0041 | 1,31 | 0,2354 | 0,0065 | 1,84 | 0,3296 | 0,0095 | 1,85 | 0,3296 | 0,0149 | 2,64 | 0,3766 | 0,0119 | 2,65 | 0,3766 | 0,0188 |
| A10- | Paß Lueg | Golling / Abtenau | 1,37 | 0,2456 | 0,0043 | 1,37 | 0,2456 | 0,0068 | 1,92 | 0,3439 | 0,0099 | 1,93 | 0,3439 | 0,0155 | 2,76 | 0,3930 | 0,0125 | 2,76 | 0,3930 | 0,0196 |
| A10- | Werfen | Paß Lueg | 1,95 | 0,3499 | 0,0061 | 1,95 | 0,3499 | 0,0096 | 2,74 | 0,4898 | 0,0141 | 2,74 | 0,4898 | 0,0221 | 3,92 | 0,5598 | 0,0178 | 3,93 | 0,5598 | 0,0279 |
| A10- | Pfarrwerfen / Werfen | Werfen | 0,25 | 0,0456 | 0,0008 | 0,25 | 0,0456 | 0,0013 | 0,36 | 0,0638 | 0,0018 | 0,36 | 0,0638 | 0,0029 | 0,51 | 0,0730 | 0,0023 | 0,51 | 0,0730 | 0,0036 |
| A10- | KN Pongau | Pfarrwerfen / Werfen | 0,55 | 0,0990 | 0,0017 | 0,55 | 0,0990 | 0,0027 | 0,77 | 0,1385 | 0,0040 | 0,78 | 0,1385 | 0,0063 | 1,11 | 0,1583 | 0,0050 | 1,11 | 0,1583 | 0,0079 |
| A101 | Bischofshofen Mühlbach a. Hochkönig | KN Pongau | 0,82 | 0,1472 | 0,0026 | 0,82 | 0,1472 | 0,0040 | 1,15 | 0,2061 | 0,0059 | 1,15 | 0,2061 | 0,0093 | 1,65 | 0,2355 | 0,0075 | 1,66 | 0,2355 | 0,0117 |
| A10- | Lammertal Hüttal | KN Pongau | 2,24 | 0,4025 | 0,0070 | 2,25 | 0,4025 | 0,0111 | 3,15 | 0,5635 | 0,0162 | 3,16 | 0,5635 | 0,0255 | 4,51 | 0,6440 | 0,0204 | 4,53 | 0,6440 | 0,0321 |
| A10- | F. Verbindung GH Eben | Lammertal Hüttal | 0,58 | 0,1036 | 0,0018 | 0,58 | 0,1036 | 0,0028 | 0,81 | 0,1450 | 0,0042 | 0,81 | 0,1450 | 0,0066 | 1,16 | 0,1658 | 0,0053 | 1,17 | 0,1658 | 0,00 |

| | | | | | | | | | | | | | | | | | | | | |
|------|-------------------------------------|-------------------------------------|------|--------|--------|------|--------|--------|------|--------|--------|------|--------|--------|-------|--------|--------|-------|--------|--------|
| A12- | Kufstein Nord | Staatsgrenze Kufstein | 0,36 | 0,0000 | 0,0000 | 0,36 | 0,0000 | 0,0000 | 0,51 | 0,0000 | 0,0000 | 0,51 | 0,0000 | 0,0000 | 0,76 | 0,0000 | 0,0000 | 0,76 | 0,0000 | 0,0000 |
| A12- | Kufstein Süd | Kufstein Nord | 0,93 | 0,0000 | 0,0000 | 0,93 | 0,0000 | 0,0000 | 1,31 | 0,0000 | 0,0000 | 1,31 | 0,0000 | 0,0000 | 1,96 | 0,0000 | 0,0000 | 1,96 | 0,0000 | 0,0000 |
| A12- | Kirchbichl Langkampfen | Kufstein Süd | 1,27 | 0,0000 | 0,0000 | 1,27 | 0,0000 | 0,0000 | 1,78 | 0,0000 | 0,0000 | 1,78 | 0,0000 | 0,0000 | 2,68 | 0,0000 | 0,0000 | 2,68 | 0,0000 | 0,0000 |
| A12- | Wörgl Ost St.Johann i. T. Brixental | Kirchbichl Langkampfen | 1,25 | 0,0000 | 0,0000 | 1,25 | 0,0000 | 0,0000 | 1,75 | 0,0000 | 0,0000 | 1,75 | 0,0000 | 0,0000 | 2,62 | 0,0000 | 0,0000 | 2,62 | 0,0000 | 0,0000 |
| A12- | Wörgl West | Wörgl Ost St.Johann i. T. Brixental | 0,66 | 0,0000 | 0,0000 | 0,66 | 0,0000 | 0,0000 | 0,92 | 0,0000 | 0,0000 | 0,92 | 0,0000 | 0,0000 | 1,38 | 0,0000 | 0,0000 | 1,38 | 0,0000 | 0,0000 |
| A12- | Kramsach Rattenberg Brixlegg | Wörgl West | 2,80 | 0,0000 | 0,0000 | 2,80 | 0,0000 | 0,0000 | 3,92 | 0,0000 | 0,0000 | 3,92 | 0,0000 | 0,0000 | 5,88 | 0,0000 | 0,0000 | 5,88 | 0,0000 | 0,0000 |
| A12- | Wiesing Achensee Zillertal | Kramsach Rattenberg Brixlegg | 1,72 | 0,0000 | 0,0000 | 1,72 | 0,0000 | 0,0000 | 2,40 | 0,0000 | 0,0000 | 2,40 | 0,0000 | 0,0000 | 3,61 | 0,0000 | 0,0000 | 3,61 | 0,0000 | 0,0000 |
| A12- | Jenbach | Wiesing Achensee Zillertal | 0,68 | 0,0000 | 0,0000 | 0,68 | 0,0000 | 0,0000 | 0,95 | 0,0000 | 0,0000 | 0,95 | 0,0000 | 0,0000 | 1,43 | 0,0000 | 0,0000 | 1,43 | 0,0000 | 0,0000 |
| A12- | Schwaz | Jenbach | 1,50 | 0,0000 | 0,0000 | 1,50 | 0,0000 | 0,0000 | 2,10 | 0,0000 | 0,0000 | 2,10 | 0,0000 | 0,0000 | 3,15 | 0,0000 | 0,0000 | 3,15 | 0,0000 | 0,0000 |
| A12- | Vomp | Schwaz | 0,86 | 0,0000 | 0,0000 | 0,86 | 0,0000 | 0,0000 | 1,20 | 0,0000 | 0,0000 | 1,20 | 0,0000 | 0,0000 | 1,80 | 0,0000 | 0,0000 | 1,80 | 0,0000 | 0,0000 |
| A12- | Wattens | Vomp | 1,77 | 0,0000 | 0,0000 | 1,77 | 0,0000 | 0,0000 | 2,47 | 0,0000 | 0,0000 | 2,47 | 0,0000 | 0,0000 | 3,71 | 0,0000 | 0,0000 | 3,71 | 0,0000 | 0,0000 |
| A12- | Hall/Tirol Mitte | Wattens | 1,57 | 0,0000 | 0,0000 | 1,57 | 0,0000 | 0,0000 | 2,19 | 0,0000 | 0,0000 | 2,19 | 0,0000 | 0,0000 | 3,29 | 0,0000 | 0,0000 | 3,29 | 0,0000 | 0,0000 |
| A12- | Hall/Tirol West | Hall/Tirol Mitte | 0,63 | 0,0000 | 0,0000 | 0,63 | 0,0000 | 0,0000 | 0,88 | 0,0000 | 0,0000 | 0,88 | 0,0000 | 0,0000 | 1,32 | 0,0000 | 0,0000 | 1,32 | 0,0000 | 0,0000 |
| A12- | A12 Innsbruck Ost | Hall/Tirol West | 0,70 | 0,0000 | 0,0000 | 0,70 | 0,0000 | 0,0000 | 0,97 | 0,0000 | 0,0000 | 0,97 | 0,0000 | 0,0000 | 1,46 | 0,0000 | 0,0000 | 1,46 | 0,0000 | 0,0000 |
| A12- | Innsbruck Mitte | A12 Innsbruck Ost | 0,48 | 0,0226 | 0,0004 | 0,48 | 0,0226 | 0,0006 | 0,67 | 0,0317 | 0,0009 | 0,67 | 0,0317 | 0,0014 | 0,99 | 0,0362 | 0,0011 | 0,99 | 0,0362 | 0,0018 |
| A12- | A12 Innsbruck West | Innsbruck Mitte | 0,71 | 0,1280 | 0,0022 | 0,71 | 0,1280 | 0,0035 | 1,00 | 0,1792 | 0,0052 | 1,00 | 0,1792 | 0,0081 | 1,44 | 0,2048 | 0,0065 | 1,44 | 0,2048 | 0,0102 |
| A12- | Innsbruck Kranebitten | A12 Innsbruck West | 0,93 | 0,1678 | 0,0029 | 0,94 | 0,1678 | 0,0046 | 1,31 | 0,2349 | 0,0068 | 1,32 | 0,2349 | 0,0106 | 1,88 | 0,2684 | 0,0085 | 1,89 | 0,2684 | 0,0134 |
| A12- | Zirl Ost Garmisch Seefeld | Innsbruck Kranebitten | 1,08 | 0,1947 | 0,0034 | 1,09 | 0,1947 | 0,0054 | 1,52 | 0,2726 | 0,0078 | 1,53 | 0,2726 | 0,0123 | 2,18 | 0,3115 | 0,0099 | 2,19 | 0,3115 | 0,0155 |
| A12- | Zirl West | Zirl Ost Garmisch Seefeld | 0,68 | 0,1218 | 0,0021 | 0,68 | 0,1218 | 0,0033 | 0,95 | 0,1705 | 0,0049 | 0,95 | 0,1705 | 0,0077 | 1,37 | 0,1949 | 0,0062 | 1,37 | 0,1949 | 0,0097 |
| A12- | Petttau | Zirl West | 1,22 | 0,2181 | 0,0038 | 1,22 | 0,2181 | 0,0060 | 1,71 | 0,3054 | 0,0088 | 1,71 | 0,3054 | 0,0138 | 2,45 | 0,3490 | 0,0111 | 2,45 | 0,3490 | 0,0174 |
| A12- | Telfs Ost | Petttau | 1,23 | 0,2205 | 0,0039 | 1,23 | 0,2205 | 0,0061 | 1,72 | 0,3087 | 0,0089 | 1,73 | 0,3087 | 0,0139 | 2,47 | 0,3528 | 0,0112 | 2,48 | 0,3528 | 0,0176 |
| A12- | Telfs West | Telfs Ost | 0,60 | 0,1077 | 0,0019 | 0,60 | 0,1077 | 0,0030 | 0,84 | 0,1508 | 0,0043 | 0,84 | 0,1508 | 0,0068 | 1,21 | 0,1723 | 0,0055 | 1,21 | 0,1723 | 0,0086 |
| A12- | Mötz Reutte | Telfs West | 1,94 | 0,3480 | 0,0061 | 1,94 | 0,3480 | 0,0096 | 2,72 | 0,4872 | 0,0140 | 2,73 | 0,4872 | 0,0220 | 3,90 | 0,5568 | 0,0177 | 3,91 | 0,5568 | 0,0278 |
| A12- | Haiming Ötztal | Mötz Reutte | 2,26 | 0,4048 | 0,0071 | 2,26 | 0,4048 | 0,0111 | 3,16 | 0,5667 | 0,0163 | 3,17 | 0,5667 | 0,0256 | 4,54 | 0,6477 | 0,0205 | 4,55 | 0,6477 | 0,0323 |
| A12- | Imst | Haiming Ötztal | 1,80 | 0,3222 | 0,0056 | 1,80 | 0,3222 | 0,0089 | 2,52 | 0,4511 | 0,0130 | 2,53 | 0,4511 | 0,0204 | 3,61 | 0,5156 | 0,0164 | 3,62 | 0,5156 | 0,0257 |
| A12- | Imst Au | Imst | 0,53 | 0,0950 | 0,0017 | 0,53 | 0,0950 | 0,0026 | 0,74 | 0,1331 | 0,0038 | 0,75 | 0,1331 | 0,0060 | 1,07 | 0,1521 | 0,0048 | 1,07 | 0,1521 | 0,0076 |
| A12- | Mils | Imst Au | 0,43 | 0,0767 | 0,0013 | 0,43 | 0,0767 | 0,0021 | 0,60 | 0,1074 | 0,0031 | 0,60 | 0,1074 | 0,0049 | 0,86 | 0,1228 | 0,0039 | 0,86 | 0,1228 | 0,0061 |
| A12- | Mils Schönwies | Mils | 1,05 | 0,1888 | 0,0033 | 1,05 | 0,1888 | 0,0052 | 1,48 | 0,2643 | 0,0076 | 1,48 | 0,2643 | 0,0119 | 2,12 | 0,3021 | 0,0096 | 2,12 | 0,3021 | 0,0151 |
| A12- | KN Oberinntal | Mils Schönwies | 0,93 | 0,1672 | 0,0029 | 0,93 | 0,1672 | 0,0046 | 1,31 | 0,2341 | 0,0067 | 1,31 | 0,2341 | 0,0106 | 1,88 | 0,2675 | 0,0085 | 1,88 | 0,2675 | 0,0133 |
| A12- | Zams | KN Oberinntal | 0,25 | 0,0440 | 0,0008 | 0,25 | 0,0440 | 0,0012 | 0,34 | 0,0616 | 0,0018 | 0,35 | 0,0616 | 0,0028 | 0,49 | 0,0704 | 0,0022 | 0,49 | 0,0704 | 0,0035 |
| A122 | Fließ | KN Oberinntal | 1,74 | 0,3128 | 0,0055 | 1,75 | 0,3128 | 0,0086 | 2,45 | 0,4379 | 0,0126 | 2,45 | 0,4379 | 0,0198 | 3,51 | 0,5005 | 0,0159 | 3,52 | 0,5005 | 0,0249 |
| A13- | A13 Innsbruck Süd | A12 Innsbruck Ost | 2,20 | 0,0000 | 0,0000 | 2,20 | 0,0000 | 0,0000 | 3,08 | 0,0000 | 0,0000 | 3,08 | 0,0000 | 0,0000 | 4,62 | 0,0000 | 0,0000 | 8,50 | 0,0000 | 0,0000 |
| A13- | Zenzenhof | A13 Innsbruck Süd | 0,88 | 0,0000 | 0,0000 | 0,88 | 0,0000 | 0,0000 | 1,23 | 0,0000 | 0,0000 | 1,23 | 0,0000 | 0,0000 | 1,84 | 0,0000 | 0,0000 | 3,68 | 0,0000 | 0,0000 |
| A13- | Igls Patsch | Zenzenhof | 1,62 | 0,0000 | 0,0000 | 1,62 | 0,0000 | 0,0000 | 2,27 | 0,0000 | 0,0000 | 2,27 | 0,0000 | 0,0000 | 3,41 | 0,0000 | 0,0000 | 6,82 | 0,0000 | 0,0000 |
| A13- | Schönberg Stubaital | Igls Patsch | 1,76 | 0,0000 | 0,0000 | 1,76 | 0,0000 | 0,0000 | 2,46 | 0,0000 | 0,0000 | 2,46 | 0,0000 | 0,0000 | 3,69 | 0,0000 | 0,0000 | 7,38 | 0,0000 | 0,0000 |
| A13- | Matrei Steinach | Schönberg Stubaital | 5,54 | 0,0000 | 0,0000 | 5,54 | 0,0000 | 0,0000 | 7,76 | 0,0000 | 0,0000 | 7,76 | 0,0000 | 0,0000 | 11,63 | 0,0000 | 0,0000 | 23,26 | 0,0000 | 0,0000 |
| A13- | Nösslach | Matrei Steinach | 4,46 | 0,0000 | 0,0000 | 4,46 | 0,0000 | 0,0000 | 6,24 | 0,0000 | 0,0000 | 6,24 | 0,0000 | 0,0000 | 9,36 | 0,0000 | 0,0000 | 18,72 | 0,0000 | 0,0000 |
| A13- | Brenner-Nord | Nösslach | 4,00 | 0,0000 | 0,0000 | 4,00 | 0,0000 | 0,0000 | 5,60 | 0,0000 | 0,0000 | 5,60 | 0,0000 | 0,0000 | 8,40 | 0,0000 | 0,0000 | 16,80 | 0,0000 | 0,0000 |
| A13- | Staatsgrenze Brennerpass | Brenner-Nord | 0,79 | 0,0000 | 0,0000 | 0,79 | 0,0000 | 0,0000 | 1,11 | 0,0000 | 0,0000 | 1,11 | 0,0000 | 0,0000 | 1,66 | 0,0000 | 0,0000 | 3,32 | 0,0000 | 0,0000 |
| A131 | A13 Innsbruck Süd | A12 Innsbruck West | 1,43 | 0,0416 | 0,0007 | 1,43 | 0,0416 | 0,0011 | 2,01 | 0,0583 | 0,0017 | 2,01 | 0,0583 | 0,0026 | 2,99 | 0,0666 | 0,0021 | 5,51 | 0,0666 | 0,0033 |
| A14- | Hörbranz Lochau | Staatsgrenze Hörbranz | 0,28 | 0,0504 | 0,0009 | 0,28 | 0,0504 | 0,0014 | 0,39 | 0,0706 | 0,0020 | 0,40 | 0,0706 | 0,0032 | 0,57 | 0,0807 | 0,0026 | 0,57 | 0,0807 | 0,0040 |
| A14- | KN Bregenz | Hörbranz Lochau | 1,73 | 0,3100 | 0,0054 | 1,73 | 0,3100 | 0,0085 | 2,42 | 0,4339 | 0,0125 | 2,43 | 0,4339 | 0,0196 | 3,48 | 0,4959 | 0,0157 | 3,49 | 0,4959 | 0,0247 |
| A14- | Lauterach Wolfurt | KN Bregenz | 0,09 | 0,0156 | 0,0003 | 0,09 | 0,0156 | 0,0004 | 0,12 | 0,0218 | 0,0006 | 0,12 | 0,0218 | 0,0010 | 0,17 | 0,0249 | 0,0008 | 0,17 | 0,0249 | 0,0012 |
| A14- | Wolfurt Lauterach | Lauterach Wolfurt | 0,77 | 0,1379 | 0,0024 | 0,77 | 0,1379 | 0,0038 | 1,08 | 0,1931 | 0,0056 | 1,08 | 0,1931 | 0,0087 | 1,55 | 0,2207 | 0,0070 | 1,55 | 0,2207 | 0,0110 |
| A14- | Dornbirn Nord Bregenzerwald | Wolfurt Lauterach | 0,30 | 0,0534 | 0,0009 | 0,30 | 0,0534 | 0,0015 | 0,42 | 0,0747 | 0,0021 | 0,42 | 0,0747 | 0,0034 | 0,60 | 0,0854 | 0,0027 | 0,60 | 0,0854 | 0,0043 |
| A14- | Dornbirn Süd Lustenau | Dornbirn Nord Bregenzerwald | 0,83 | 0,1491 | 0,0026 | 0,83 | 0,1491 | 0,0041 | 1,17 | 0,2087 | 0,0060 | 1,17 | 0,2087 | 0,0094 | 1,67 | 0,2385 | 0,0076 | 1,68 | 0,2385 | 0,0119 |
| A14- | Hohenems | Dornbirn Süd Lustenau | 1,17 | 0,2098 | 0,0037 | 1,17 | 0,2098 | 0,0058 | 1,64 | 0,2937 | 0,0084 | 1,64 | 0,2937 | 0,0133 | 2,35 | 0,3356 | 0,0106 | 2,36 | 0,3356 | 0,0167 |
| A14- | Altach Götzis | Hohenems | 0,76 | 0,1368 | 0,0024 | 0,76 | 0,1368 | 0,0038 | 1,07 | 0,1915 | 0,0055 | 1,07 | 0,1915 | 0,0087 | 1,53 | 0,2188 | 0,0069 | 1,54 | 0,2188 | 0,0109 |
| A14- | Götzis | Altach Götzis | 0,58 | 0,1043 | 0,0018 | 0,58 | 0,1043 | 0,0029 | 0,82 | 0,1460 | 0,0042 | 0,82 | 0,1460 | 0,0066 | 1,17 | 0,1668 | 0,0053 | 1,17 | 0,1668 | 0,0083 |
| A14- | Klaus Koblach | Götzis | 0,50 | 0,0906 | 0,0016 | 0,51 | 0,0906 | 0,0025 | 0,71 | 0,1268 | 0,0036 | 0,71 | 0,1268 | 0,0057 | 1,02 | 0,1449 | 0,0046 | 1,02 | 0,1449 | 0,0072 |
| A14- | Rankweil | Klaus Koblach | 0,89 | 0,1592 | 0,0028 | 0,89 | 0,1592 | 0,0044 | 1,24 | 0,2228 | 0,0064 | 1,25 | 0,2228 | 0,0101 | 1,79 | 0,2547 | 0,0081 | 1,79 | 0,2547 | 0,0127 |
| A14- | Feldkirch Frastanz | Rankweil | 1,26 | 0,2267 | 0,0040 | 1,27 | 0,2267 | 0,0062 | 1,77 | 0,3174 | 0,0091 | 1,78 | 0,3174 | 0,0143 | 2,54 | 0,3628 | 0,0115 | 2,55 | 0,3628 | 0,0181 |
| A14- | Nenzing Bludesch | Feldkirch Frastanz | 2,00 | 0,3585 | 0,0063 | 2,00 | 0,3585 | 0,0099 | 2,80 | 0,5019 | 0,0144 | 2,81 | 0,5019 | 0,0227 | 4,02 | 0,5736 | 0,0182 | 4,03 | 0,5736 | 0,0286 |
| A14- | Bludenz Nüziders | Nenzing Bludesch | 1,48 | 0,2662 | 0,0047 | 1,49 | 0,2662 | 0,0073 | 2,08 | 0,3726 | 0,0107 | 2,09 | 0,3726 | 0,0168 | 2,99 | 0,4259 | 0,0135 | 2,99 | 0,4259 | 0,0212 |
| A14- | Brandnertal | Bludenz Nüziders | 0,21 | 0,0370 | 0,0006 | 0,21 | 0,0370 | 0,0010 | 0,29 | 0,0519 | 0,0015 | 0,29 | 0,0519 | 0,0023 | 0,42 | 0,0593 | 0,0019 | 0,42 | 0,0593 | 0,0030 |
| A14- | Bludenz Bürs | Brandnertal | 0,34 | 0,0618 | 0,0011 | 0,35 | 0,0618 | 0,0017 | 0,48 | 0,0865 | 0,0025 | 0,48 | 0,0865 | 0,0039 | 0,69 | 0,0989 | 0,0031 | 0,69 | 0,0989 | 0,0049 |
| A14- | Bludenz Montafon | Bludenz Bürs | 0,49 | 0,087 | | | | | | | | | | | | | | | | |

| | | | | | | | | | | | | | | | | | | | | |
|------|--------------------------------------|--------------------------------------|------|--------|--------|------|--------|--------|------|--------|--------|------|--------|--------|------|--------|--------|------|--------|--------|
| A22- | Strebersdorf | KN Gürtel Nordbrücke | 0,67 | 0,1203 | 0,0021 | 0,67 | 0,1203 | 0,0033 | 0,94 | 0,1684 | 0,0048 | 0,94 | 0,1684 | 0,0076 | 1,35 | 0,1925 | 0,0061 | 1,35 | 0,1925 | 0,0096 |
| A221 | KN Gürtel Nordbrücke | Wien Nordbrücke | 0,20 | 0,0355 | 0,0006 | 0,20 | 0,0355 | 0,0010 | 0,28 | 0,0497 | 0,0014 | 0,28 | 0,0497 | 0,0022 | 0,40 | 0,0568 | 0,0018 | 0,40 | 0,0568 | 0,0028 |
| A221 | Wien Pragerstraße | KN Gürtel Nordbrücke | 0,21 | 0,0382 | 0,0007 | 0,21 | 0,0382 | 0,0011 | 0,30 | 0,0535 | 0,0015 | 0,30 | 0,0535 | 0,0024 | 0,43 | 0,0611 | 0,0019 | 0,43 | 0,0611 | 0,0030 |
| A221 | Wien Neujedlersdorf | Wien Pragerstraße | 0,09 | 0,0167 | 0,0003 | 0,09 | 0,0167 | 0,0005 | 0,13 | 0,0234 | 0,0007 | 0,13 | 0,0234 | 0,0011 | 0,19 | 0,0268 | 0,0008 | 0,19 | 0,0268 | 0,0013 |
| A221 | Brünnerstr/Shuttlewort hstraße | Wien Neujedlersdorf | 0,24 | 0,0424 | 0,0007 | 0,24 | 0,0424 | 0,0012 | 0,33 | 0,0594 | 0,0017 | 0,33 | 0,0594 | 0,0027 | 0,48 | 0,0678 | 0,0022 | 0,48 | 0,0678 | 0,0034 |
| A22- | Korneuburg Ost | Strebersdorf | 1,35 | 0,2424 | 0,0042 | 1,35 | 0,2424 | 0,0067 | 1,90 | 0,3394 | 0,0098 | 1,90 | 0,3394 | 0,0153 | 2,72 | 0,3878 | 0,0123 | 2,72 | 0,3878 | 0,0193 |
| A222 | Wien Vohburggasse | Strebersdorf | 0,17 | 0,0301 | 0,0005 | 0,17 | 0,0301 | 0,0008 | 0,24 | 0,0422 | 0,0012 | 0,24 | 0,0422 | 0,0019 | 0,34 | 0,0482 | 0,0015 | 0,34 | 0,0482 | 0,0024 |
| A22- | KN Korneuburg | Korneuburg Ost | 0,87 | 0,1564 | 0,0027 | 0,87 | 0,1564 | 0,0043 | 1,22 | 0,2190 | 0,0063 | 1,23 | 0,2190 | 0,0099 | 1,75 | 0,2503 | 0,0079 | 1,76 | 0,2503 | 0,0125 |
| A22- | Stockerau Ost | KN Korneuburg | 1,27 | 0,2276 | 0,0040 | 1,27 | 0,2276 | 0,0063 | 1,78 | 0,3186 | 0,0092 | 1,78 | 0,3186 | 0,0144 | 2,55 | 0,3642 | 0,0116 | 2,56 | 0,3642 | 0,0182 |
| A22- | Stockerau Mitte | Stockerau Ost | 0,51 | 0,0908 | 0,0016 | 0,51 | 0,0908 | 0,0025 | 0,71 | 0,1271 | 0,0037 | 0,71 | 0,1271 | 0,0057 | 1,02 | 0,1452 | 0,0046 | 1,02 | 0,1452 | 0,0072 |
| A22- | KN Stockerau/West | Stockerau Mitte | 0,43 | 0,0771 | 0,0013 | 0,43 | 0,0771 | 0,0021 | 0,60 | 0,1079 | 0,0031 | 0,60 | 0,1079 | 0,0049 | 0,86 | 0,1233 | 0,0039 | 0,87 | 0,1233 | 0,0061 |
| A23- | KN Wien Inzersdorf | Altmannsdorferstraße | 0,38 | 0,0674 | 0,0012 | 0,38 | 0,0674 | 0,0019 | 0,53 | 0,0944 | 0,0027 | 0,53 | 0,0944 | 0,0043 | 0,76 | 0,1079 | 0,0034 | 0,76 | 0,1079 | 0,0054 |
| A23- | Favoriten | KN Wien Inzersdorf | 0,95 | 0,1701 | 0,0030 | 0,95 | 0,1701 | 0,0047 | 1,33 | 0,2381 | 0,0068 | 1,33 | 0,2381 | 0,0108 | 1,91 | 0,2721 | 0,0086 | 1,91 | 0,2721 | 0,0136 |
| A23- | KN Gürtel Landstraßer Hauptstraße | Favoriten | 0,59 | 0,1065 | 0,0019 | 0,59 | 0,1065 | 0,0029 | 0,83 | 0,1491 | 0,0043 | 0,84 | 0,1491 | 0,0067 | 1,19 | 0,1704 | 0,0054 | 1,20 | 0,1704 | 0,0085 |
| A23- | St. Marx | KN Gürtel Landstraßer Hauptstraße | 0,23 | 0,0404 | 0,0007 | 0,23 | 0,0404 | 0,0011 | 0,32 | 0,0566 | 0,0016 | 0,32 | 0,0566 | 0,0026 | 0,45 | 0,0647 | 0,0021 | 0,45 | 0,0647 | 0,0032 |
| A23- | KN Wien Prater | St. Marx | 0,19 | 0,0343 | 0,0006 | 0,19 | 0,0343 | 0,0009 | 0,27 | 0,0480 | 0,0014 | 0,27 | 0,0480 | 0,0022 | 0,38 | 0,0549 | 0,0017 | 0,39 | 0,0549 | 0,0027 |
| A23- | Handelskai | KN Wien Prater | 0,42 | 0,0762 | 0,0013 | 0,43 | 0,0762 | 0,0021 | 0,60 | 0,1067 | 0,0031 | 0,60 | 0,1067 | 0,0048 | 0,85 | 0,1219 | 0,0039 | 0,86 | 0,1219 | 0,0061 |
| A23- | KN Wien Kaisermühlen | Handelskai | 0,19 | 0,0348 | 0,0006 | 0,19 | 0,0348 | 0,0010 | 0,27 | 0,0488 | 0,0014 | 0,27 | 0,0488 | 0,0022 | 0,39 | 0,0557 | 0,0018 | 0,39 | 0,0557 | 0,0028 |
| A23- | Groß Enzersdorf Stadlau | KN Wien Kaisermühlen | 0,53 | 0,0956 | 0,0017 | 0,53 | 0,0956 | 0,0026 | 0,75 | 0,1338 | 0,0038 | 0,75 | 0,1338 | 0,0060 | 1,07 | 0,1530 | 0,0049 | 1,08 | 0,1530 | 0,0076 |
| A23- | Hirschstetten | Groß Enzersdorf Stadlau | 0,30 | 0,0536 | 0,0009 | 0,30 | 0,0536 | 0,0015 | 0,42 | 0,0750 | 0,0022 | 0,42 | 0,0750 | 0,0034 | 0,60 | 0,0858 | 0,0027 | 0,60 | 0,0858 | 0,0043 |
| A233 | Wien Gürtel | KN Gürtel Landstraßer Hauptstraße | 0,17 | 0,0313 | 0,0005 | 0,17 | 0,0313 | 0,0009 | 0,24 | 0,0438 | 0,0013 | 0,25 | 0,0438 | 0,0020 | 0,35 | 0,0500 | 0,0016 | 0,35 | 0,0500 | 0,0025 |
| A25- | Weißkirchen | KN A1/A25 Passau Wels | 1,96 | 0,3526 | 0,0062 | 1,97 | 0,3526 | 0,0097 | 2,76 | 0,4936 | 0,0142 | 2,76 | 0,4936 | 0,0223 | 3,95 | 0,5642 | 0,0179 | 3,97 | 0,5642 | 0,0281 |
| A25- | Marchtrenk Wels Ost | Weißkirchen | 0,70 | 0,1256 | 0,0022 | 0,70 | 0,1256 | 0,0035 | 0,98 | 0,1759 | 0,0051 | 0,99 | 0,1759 | 0,0079 | 1,41 | 0,2010 | 0,0064 | 1,41 | 0,2010 | 0,0100 |
| A25- | ÖBB Terminal Wels | Marchtrenk Wels Ost | 0,19 | 0,0338 | 0,0006 | 0,19 | 0,0338 | 0,0009 | 0,26 | 0,0473 | 0,0014 | 0,26 | 0,0473 | 0,0021 | 0,38 | 0,0541 | 0,0017 | 0,38 | 0,0541 | 0,0027 |
| A25- | Wels Nord | ÖBB Terminal Wels | 0,90 | 0,1620 | 0,0028 | 0,90 | 0,1620 | 0,0045 | 1,27 | 0,2269 | 0,0065 | 1,27 | 0,2269 | 0,0102 | 1,82 | 0,2593 | 0,0082 | 1,82 | 0,2593 | 0,0129 |
| A25- | KN Wels | Wels Nord | 0,64 | 0,1153 | 0,0020 | 0,64 | 0,1153 | 0,0032 | 0,90 | 0,1614 | 0,0046 | 0,90 | 0,1614 | 0,0073 | 1,29 | 0,1844 | 0,0059 | 1,30 | 0,1844 | 0,0092 |
| S01- | Vorarlberger Allee | KN Vösendorf | 0,48 | 0,0855 | 0,0015 | 0,48 | 0,0855 | 0,0024 | 0,67 | 0,1197 | 0,0034 | 0,67 | 0,1197 | 0,0054 | 0,96 | 0,1368 | 0,0043 | 0,96 | 0,1368 | 0,0068 |
| S01- | Laxenburger Str. | Vorarlberger Allee | 0,25 | 0,0449 | 0,0008 | 0,25 | 0,0449 | 0,0012 | 0,35 | 0,0628 | 0,0018 | 0,35 | 0,0628 | 0,0028 | 0,50 | 0,0718 | 0,0023 | 0,50 | 0,0718 | 0,0036 |
| S01- | Güterzentrum Wien Süd | Laxenburger Str. | 0,31 | 0,0556 | 0,0010 | 0,31 | 0,0556 | 0,0015 | 0,43 | 0,0779 | 0,0022 | 0,44 | 0,0779 | 0,0035 | 0,62 | 0,0890 | 0,0028 | 0,63 | 0,0890 | 0,0044 |
| S01- | Rothneusiedl | Güterzentrum Wien Süd | 0,20 | 0,0362 | 0,0006 | 0,20 | 0,0362 | 0,0010 | 0,28 | 0,0506 | 0,0015 | 0,28 | 0,0506 | 0,0023 | 0,41 | 0,0579 | 0,0018 | 0,41 | 0,0579 | 0,0029 |
| S01- | KN Rustenfeld | Rothneusiedl | 0,47 | 0,0846 | 0,0015 | 0,47 | 0,0846 | 0,0023 | 0,66 | 0,1184 | 0,0034 | 0,66 | 0,1184 | 0,0054 | 0,95 | 0,1354 | 0,0043 | 0,95 | 0,1354 | 0,0067 |
| S01- | Rannersdorf | KN Rustenfeld | 0,66 | 0,1187 | 0,0021 | 0,66 | 0,1187 | 0,0033 | 0,93 | 0,1662 | 0,0048 | 0,93 | 0,1662 | 0,0075 | 1,33 | 0,1900 | 0,0060 | 1,34 | 0,1900 | 0,0095 |
| S011 | Leopoldsdorf (B16) | KN Rustenfeld | 0,29 | 0,0526 | 0,0009 | 0,29 | 0,0526 | 0,0014 | 0,41 | 0,0736 | 0,0021 | 0,41 | 0,0736 | 0,0033 | 0,59 | 0,0842 | 0,0027 | 0,59 | 0,0842 | 0,0042 |
| S01- | Schwechat Süd | Rannersdorf | 0,52 | 0,0928 | 0,0016 | 0,52 | 0,0928 | 0,0026 | 0,73 | 0,1299 | 0,0037 | 0,73 | 0,1299 | 0,0059 | 1,04 | 0,1484 | 0,0047 | 1,04 | 0,1484 | 0,0074 |
| S01- | Schwechat Ost | Schwechat Süd | 0,30 | 0,0531 | 0,0009 | 0,30 | 0,0531 | 0,0015 | 0,42 | 0,0744 | 0,0021 | 0,42 | 0,0744 | 0,0034 | 0,60 | 0,0850 | 0,0027 | 0,60 | 0,0850 | 0,0042 |
| S01- | Mannswörth | Schwechat Ost | 0,31 | 0,0562 | 0,0010 | 0,31 | 0,0562 | 0,0015 | 0,44 | 0,0787 | 0,0023 | 0,44 | 0,0787 | 0,0036 | 0,63 | 0,0900 | 0,0029 | 0,63 | 0,0900 | 0,0045 |
| S01- | KN Schwechat | Mannswörth | 0,12 | 0,0211 | 0,0004 | 0,12 | 0,0211 | 0,0006 | 0,16 | 0,0295 | 0,0008 | 0,17 | 0,0295 | 0,0013 | 0,24 | 0,0337 | 0,0011 | 0,24 | 0,0337 | 0,0017 |
| S01- | Seyring | Angerner Straße | 1,10 | 0,1971 | 0,0034 | 1,10 | 0,1971 | 0,0054 | 1,54 | 0,2759 | 0,0079 | 1,55 | 0,2759 | 0,0125 | 2,21 | 0,3153 | 0,0100 | 2,22 | 0,3153 | 0,0157 |
| S01- | KN Eibesbrunn | Seyring | 0,92 | 0,1649 | 0,0029 | 0,92 | 0,1649 | 0,0045 | 1,29 | 0,2308 | 0,0066 | 1,29 | 0,2308 | 0,0104 | 1,85 | 0,2638 | 0,0084 | 1,85 | 0,2638 | 0,0131 |
| S01- | Hagenbrunn | KN Eibesbrunn | 0,72 | 0,1298 | 0,0023 | 0,72 | 0,1298 | 0,0036 | 1,01 | 0,1817 | 0,0052 | 1,02 | 0,1817 | 0,0082 | 1,46 | 0,2077 | 0,0066 | 1,46 | 0,2077 | 0,0104 |
| S01- | Korneuburg Nord | Hagenbrunn | 1,55 | 0,2777 | 0,0049 | 1,55 | 0,2777 | 0,0076 | 2,17 | 0,3888 | 0,0112 | 2,18 | 0,3888 | 0,0176 | 3,11 | 0,4443 | 0,0141 | 3,12 | 0,4443 | 0,0221 |
| S01- | Korneuburg West | Korneuburg Nord | 0,63 | 0,1126 | 0,0020 | 0,63 | 0,1126 | 0,0031 | 0,88 | 0,1577 | 0,0045 | 0,88 | 0,1577 | 0,0071 | 1,26 | 0,1802 | 0,0057 | 1,27 | 0,1802 | 0,0090 |
| S01- | KN Korneuburg | Korneuburg West | 0,20 | 0,0359 | 0,0006 | 0,20 | 0,0359 | 0,0010 | 0,28 | 0,0503 | 0,0014 | 0,28 | 0,0503 | 0,0023 | 0,40 | 0,0575 | 0,0018 | 0,40 | 0,0575 | 0,0029 |
| S02- | Gewerbepark Stadlau | Hirschstetten | 0,22 | 0,0386 | 0,0007 | 0,22 | 0,0386 | 0,0011 | 0,30 | 0,0540 | 0,0016 | 0,30 | 0,0540 | 0,0024 | 0,43 | 0,0618 | 0,0020 | 0,43 | 0,0618 | 0,0031 |
| S02- | Breitenleer Straße | Gewerbepark Stadlau | 0,12 | 0,0214 | 0,0004 | 0,12 | 0,0214 | 0,0006 | 0,17 | 0,0300 | 0,0009 | 0,17 | 0,0300 | 0,0014 | 0,24 | 0,0342 | 0,0011 | 0,24 | 0,0342 | 0,0017 |
| S02- | Rautenweg | Breitenleer Straße | 0,20 | 0,0355 | 0,0006 | 0,20 | 0,0355 | 0,0010 | 0,28 | 0,0497 | 0,0014 | 0,28 | 0,0497 | 0,0022 | 0,40 | 0,0568 | 0,0018 | 0,40 | 0,0568 | 0,0028 |
| S02- | Hermann Gebauer Straße | Rautenweg | 0,22 | 0,0390 | 0,0007 | 0,22 | 0,0390 | 0,0011 | 0,31 | 0,0547 | 0,0016 | 0,31 | 0,0547 | 0,0025 | 0,44 | 0,0625 | 0,0020 | 0,44 | 0,0625 | 0,0031 |
| S02- | Angerner Straße | Hermann Gebauer Straße | 0,79 | 0,1413 | 0,0025 | 0,79 | 0,1413 | 0,0039 | 1,10 | 0,1978 | 0,0057 | 1,11 | 0,1978 | 0,0089 | 1,58 | 0,2260 | 0,0072 | 1,59 | 0,2260 | 0,0113 |
| S03- | Stockerau Nord | KN Stockerau/West | 0,22 | 0,0399 | 0,0007 | 0,22 | 0,0399 | 0,0011 | 0,31 | 0,0559 | 0,0016 | 0,31 | 0,0559 | 0,0025 | 0,45 | 0,0639 | 0,0020 | 0,45 | 0,0639 | 0,0032 |
| S03- | Sierndorf | Stockerau Nord | 1,20 | 0,2146 | 0,0038 | 1,20 | 0,2146 | 0,0059 | 1,68 | 0,3004 | 0,0086 | 1,68 | 0,3004 | 0,0136 | 2,41 | 0,3433 | 0,0109 | 2,41 | 0,3433 | 0,0171 |
| S03- | Obermallebarn | Sierndorf | 0,80 | 0,1441 | 0,0025 | 0,80 | 0,1441 | 0,0040 | 1,13 | 0,2017 | 0,0058 | 1,13 | 0,2017 | 0,0091 | 1,62 | 0,2305 | 0,0073 | 1,62 | 0,2305 | 0,0115 |
| S03- | Göllersdorf | Obermallebarn | 1,06 | 0,1902 | 0,0033 | 1,06 | 0,1902 | 0,0052 | 1,49 | 0,2663 | 0,0077 | 1,49 | 0,2663 | 0,0120 | 2,13 | 0,3044 | 0,0097 | 2,14 | 0,3044 | 0,0152 |
| S03- | Großstelzendorf | Göllersdorf | 0,42 | 0,0762 | 0,0013 | 0,43 | 0,0762 | 0,0021 | 0,60 | 0,1067 | 0,0031 | 0,60 | 0,1067 | 0,0048 | 0,85 | 0,1219 | 0,0039 | 0,86 | 0,1219 | 0,0061 |
| S03- | Hollabrunn Süd | Großstelzendorf | 1,02 | 0,1832 | 0,0032 | 1,02 | 0,1832 | 0,0050 | 1,43 | 0,2565 | 0,0074 | 1,44 | 0,2565 | 0,0116 | 2,06 | 0,2932 | 0,0093 | 2,06 | 0,2932 | 0,0146 |
| S04- | Sigleß | KN Mattersburg | 0,53 | 0,0947 | 0,0017 | 0,53 | 0,0947 | 0,0026 | 0,74 | 0,1326 | 0,0038 | 0,74 | 0,1326 | 0,0060 | 1,06 | 0,1516 | 0,0048 | 1,07 | 0,1516 | 0,0076 |
| S04- | Bad Sauerbrunn | Sigleß | 1,23 | 0,2213 | 0,0039 | 1,24 | 0,2213 | 0,0061 | 1,73 | 0,3098 | 0,0089 | 1,74 | 0,3098 | 0,0140 | 2,48 | 0,3541 | 0,0112 | 2,49 | 0,3541 | 0,0177 |
| S04- | | | | | | | | | | | | | | | | | | | | |

| | | | | | | | | | | | | | | | | | | | | |
|------|-----------------------------------|-----------------------------------|------|--------|--------|------|--------|--------|-------|--------|--------|-------|--------|--------|-------|--------|--------|-------|--------|--------|
| S06- | Gloggnitz | Neunkirchen | 2,71 | 0,4868 | 0,0085 | 2,72 | 0,4868 | 0,0134 | 3,81 | 0,6815 | 0,0196 | 3,82 | 0,6815 | 0,0308 | 5,46 | 0,7789 | 0,0247 | 5,47 | 0,7789 | 0,0388 |
| S06- | Maria Schutz | Gloggnitz | 1,73 | 0,3103 | 0,0054 | 1,73 | 0,3103 | 0,0085 | 2,43 | 0,4344 | 0,0125 | 2,43 | 0,4344 | 0,0196 | 3,48 | 0,4964 | 0,0157 | 3,49 | 0,4964 | 0,0247 |
| S06- | Spital / Semmering | Maria Schutz | 1,47 | 0,2634 | 0,0046 | 1,47 | 0,2634 | 0,0072 | 2,06 | 0,3687 | 0,0106 | 2,06 | 0,3687 | 0,0167 | 2,95 | 0,4214 | 0,0134 | 2,96 | 0,4214 | 0,0210 |
| S06- | Mürzzuschlag Ost | Spital / Semmering | 1,23 | 0,2200 | 0,0039 | 1,23 | 0,2200 | 0,0061 | 1,72 | 0,3080 | 0,0089 | 1,72 | 0,3080 | 0,0139 | 2,47 | 0,3520 | 0,0112 | 2,47 | 0,3520 | 0,0175 |
| S06- | Mariazell, Mürzsteg, Mürzzuschlag | Mürzzuschlag Ost | 1,09 | 0,1950 | 0,0034 | 1,09 | 0,1950 | 0,0054 | 1,52 | 0,2731 | 0,0079 | 1,53 | 0,2731 | 0,0123 | 2,19 | 0,3121 | 0,0099 | 2,19 | 0,3121 | 0,0156 |
| S06- | Hönigsberg | Mariazell, Mürzsteg, Mürzzuschlag | 0,78 | 0,1391 | 0,0024 | 0,78 | 0,1391 | 0,0038 | 1,09 | 0,1947 | 0,0056 | 1,09 | 0,1947 | 0,0088 | 1,56 | 0,2225 | 0,0071 | 1,56 | 0,2225 | 0,0111 |
| S06- | Langenwang | Hönigsberg | 0,43 | 0,0769 | 0,0013 | 0,43 | 0,0769 | 0,0021 | 0,60 | 0,1077 | 0,0031 | 0,60 | 0,1077 | 0,0049 | 0,86 | 0,1231 | 0,0039 | 0,87 | 0,1231 | 0,0061 |
| S06- | Krieglach | Langenwang | 0,51 | 0,0914 | 0,0016 | 0,51 | 0,0914 | 0,0025 | 0,71 | 0,1279 | 0,0037 | 0,72 | 0,1279 | 0,0058 | 1,02 | 0,1462 | 0,0046 | 1,03 | 0,1462 | 0,0073 |
| S06- | Mitterdorf | Krieglach | 1,29 | 0,2309 | 0,0040 | 1,29 | 0,2309 | 0,0064 | 1,81 | 0,3233 | 0,0093 | 1,81 | 0,3233 | 0,0146 | 2,59 | 0,3695 | 0,0117 | 2,60 | 0,3695 | 0,0184 |
| S06- | Kindberg Ost | Mitterdorf | 1,31 | 0,2348 | 0,0041 | 1,31 | 0,2348 | 0,0065 | 1,84 | 0,3287 | 0,0095 | 1,84 | 0,3287 | 0,0149 | 2,63 | 0,3757 | 0,0119 | 2,64 | 0,3757 | 0,0187 |
| S06- | Kindberg West | Kindberg Ost | 0,28 | 0,0504 | 0,0009 | 0,28 | 0,0504 | 0,0014 | 0,39 | 0,0706 | 0,0020 | 0,40 | 0,0706 | 0,0032 | 0,57 | 0,0806 | 0,0026 | 0,57 | 0,0806 | 0,0040 |
| S06- | Kindberg Dörfel | Kindberg West | 0,28 | 0,0504 | 0,0009 | 0,28 | 0,0504 | 0,0014 | 0,39 | 0,0705 | 0,0020 | 0,39 | 0,0705 | 0,0032 | 0,56 | 0,0806 | 0,0026 | 0,57 | 0,0806 | 0,0040 |
| S06- | Allerheiligen Mürzhofen | Kindberg Dörfel | 0,63 | 0,1134 | 0,0020 | 0,63 | 0,1134 | 0,0031 | 0,89 | 0,1588 | 0,0046 | 0,89 | 0,1588 | 0,0072 | 1,27 | 0,1815 | 0,0058 | 1,28 | 0,1815 | 0,0090 |
| S06- | St. Marein | Allerheiligen Mürzhofen | 0,95 | 0,1704 | 0,0030 | 0,95 | 0,1704 | 0,0047 | 1,33 | 0,2386 | 0,0069 | 1,34 | 0,2386 | 0,0108 | 1,91 | 0,2726 | 0,0086 | 1,92 | 0,2726 | 0,0136 |
| S06- | Kapfenberg | St. Marein | 0,67 | 0,1208 | 0,0021 | 0,67 | 0,1208 | 0,0033 | 0,94 | 0,1691 | 0,0049 | 0,95 | 0,1691 | 0,0076 | 1,35 | 0,1933 | 0,0061 | 1,36 | 0,1933 | 0,0096 |
| S06- | KN Bruck/Mur | Kapfenberg | 1,26 | 0,2255 | 0,0039 | 1,26 | 0,2255 | 0,0062 | 1,76 | 0,3157 | 0,0091 | 1,77 | 0,3157 | 0,0143 | 2,53 | 0,3608 | 0,0114 | 2,54 | 0,3608 | 0,0180 |
| S06- | ASt Bruck/Mur | KN Bruck/Mur | 1,08 | 0,1934 | 0,0034 | 1,08 | 0,1934 | 0,0053 | 1,51 | 0,2708 | 0,0078 | 1,52 | 0,2708 | 0,0122 | 2,17 | 0,3095 | 0,0098 | 2,18 | 0,3095 | 0,0154 |
| S06- | Niklasdorf | ASt Bruck/Mur | 1,00 | 0,1787 | 0,0031 | 1,00 | 0,1787 | 0,0049 | 1,40 | 0,2502 | 0,0072 | 1,40 | 0,2502 | 0,0113 | 2,00 | 0,2860 | 0,0091 | 2,01 | 0,2860 | 0,0143 |
| S06- | Leoben Ost | Niklasdorf | 1,06 | 0,1906 | 0,0033 | 1,06 | 0,1906 | 0,0052 | 1,49 | 0,2669 | 0,0077 | 1,49 | 0,2669 | 0,0121 | 2,14 | 0,3050 | 0,0097 | 2,14 | 0,3050 | 0,0152 |
| S06- | Leoben West | Leoben Ost | 1,19 | 0,2136 | 0,0037 | 1,19 | 0,2136 | 0,0059 | 1,67 | 0,2990 | 0,0086 | 1,67 | 0,2990 | 0,0135 | 2,40 | 0,3417 | 0,0108 | 2,40 | 0,3417 | 0,0170 |
| S06- | KN St. Michael | Leoben West | 1,47 | 0,2644 | 0,0046 | 1,48 | 0,2644 | 0,0073 | 2,07 | 0,3701 | 0,0106 | 2,07 | 0,3701 | 0,0167 | 2,97 | 0,4230 | 0,0134 | 2,97 | 0,4230 | 0,0211 |
| S10- | Neumarkt | Unterweikersdorf | 1,49 | 0,2679 | 0,0047 | 1,50 | 0,2679 | 0,0074 | 2,09 | 0,3750 | 0,0108 | 2,10 | 0,3750 | 0,0169 | 3,00 | 0,4286 | 0,0136 | 3,01 | 0,4286 | 0,0214 |
| S10- | Kefermarkt | Neumarkt | 0,86 | 0,1538 | 0,0027 | 0,86 | 0,1538 | 0,0042 | 1,20 | 0,2154 | 0,0062 | 1,21 | 0,2154 | 0,0097 | 1,73 | 0,2461 | 0,0078 | 1,73 | 0,2461 | 0,0123 |
| S10- | Freistadt / Süd | Kefermarkt | 0,92 | 0,1655 | 0,0029 | 0,92 | 0,1655 | 0,0046 | 1,29 | 0,2317 | 0,0067 | 1,30 | 0,2317 | 0,0105 | 1,86 | 0,2648 | 0,0084 | 1,86 | 0,2648 | 0,0132 |
| S10- | Grünbach Sandl | Freistadt / Süd | 0,98 | 0,1750 | 0,0031 | 0,98 | 0,1750 | 0,0048 | 1,37 | 0,2451 | 0,0070 | 1,37 | 0,2451 | 0,0111 | 1,96 | 0,2801 | 0,0089 | 1,97 | 0,2801 | 0,0140 |
| S10- | Freistadt / Nord | Grünbach Sandl | 0,27 | 0,0481 | 0,0008 | 0,27 | 0,0481 | 0,0013 | 0,38 | 0,0673 | 0,0019 | 0,38 | 0,0673 | 0,0030 | 0,54 | 0,0769 | 0,0024 | 0,54 | 0,0769 | 0,0038 |
| S16- | Landeck West | Zams | 1,14 | 0,2046 | 0,0036 | 1,14 | 0,2046 | 0,0056 | 1,60 | 0,2864 | 0,0082 | 1,60 | 0,2864 | 0,0129 | 2,29 | 0,3274 | 0,0104 | 2,30 | 0,3274 | 0,0163 |
| S16- | Pians | Landeck West | 0,73 | 0,1310 | 0,0023 | 0,73 | 0,1310 | 0,0036 | 1,02 | 0,1835 | 0,0053 | 1,03 | 0,1835 | 0,0083 | 1,47 | 0,2097 | 0,0067 | 1,47 | 0,2097 | 0,0105 |
| S16- | Flirsch | Pians | 1,45 | 0,2597 | 0,0045 | 1,45 | 0,2597 | 0,0071 | 2,03 | 0,3636 | 0,0105 | 2,04 | 0,3636 | 0,0164 | 2,91 | 0,4156 | 0,0132 | 2,92 | 0,4156 | 0,0207 |
| S16- | Schnann am Arlberg | Flirsch | 0,91 | 0,1630 | 0,0029 | 0,91 | 0,1630 | 0,0045 | 1,27 | 0,2283 | 0,0066 | 1,28 | 0,2283 | 0,0103 | 1,83 | 0,2609 | 0,0083 | 1,83 | 0,2609 | 0,0130 |
| S16- | Pettneu | Schnann am Arlberg | 0,66 | 0,1185 | 0,0021 | 0,66 | 0,1185 | 0,0033 | 0,93 | 0,1659 | 0,0048 | 0,93 | 0,1659 | 0,0075 | 1,33 | 0,1896 | 0,0060 | 1,33 | 0,1896 | 0,0095 |
| S16- | St. Anton/Arlberg | Pettneu | 0,37 | 0,0660 | 0,0012 | 0,37 | 0,0660 | 0,0018 | 0,52 | 0,0924 | 0,0027 | 0,52 | 0,0924 | 0,0042 | 0,74 | 0,1056 | 0,0033 | 0,74 | 0,1056 | 0,0053 |
| S16- | Langen/Arlberg | St. Anton/Arlberg | 8,43 | 0,6421 | 0,0112 | 8,43 | 0,6421 | 0,0177 | 11,81 | 0,8990 | 0,0258 | 11,82 | 0,8990 | 0,0406 | 17,39 | 1,0274 | 0,0326 | 17,41 | 1,0274 | 0,0512 |
| S16- | Wald/Arlberg | Langen/Arlberg | 1,17 | 0,2103 | 0,0037 | 1,17 | 0,2103 | 0,0058 | 1,64 | 0,2944 | 0,0085 | 1,65 | 0,2944 | 0,0133 | 2,36 | 0,3365 | 0,0107 | 2,37 | 0,3365 | 0,0168 |
| S16- | Dalaas | Wald/Arlberg | 1,34 | 0,2396 | 0,0042 | 1,34 | 0,2396 | 0,0066 | 1,87 | 0,3354 | 0,0096 | 1,88 | 0,3354 | 0,0152 | 2,69 | 0,3833 | 0,0122 | 2,69 | 0,3833 | 0,0191 |
| S16- | Braz Ost | Dalaas | 0,76 | 0,1358 | 0,0024 | 0,76 | 0,1358 | 0,0037 | 1,06 | 0,1901 | 0,0055 | 1,06 | 0,1901 | 0,0086 | 1,52 | 0,2173 | 0,0069 | 1,53 | 0,2173 | 0,0108 |
| S16- | Braz West | Braz Ost | 0,59 | 0,1060 | 0,0019 | 0,59 | 0,1060 | 0,0029 | 0,83 | 0,1483 | 0,0043 | 0,83 | 0,1483 | 0,0067 | 1,19 | 0,1695 | 0,0054 | 1,19 | 0,1695 | 0,0085 |
| S16- | Bings | Braz West | 0,80 | 0,1436 | 0,0025 | 0,80 | 0,1436 | 0,0039 | 1,12 | 0,2010 | 0,0058 | 1,13 | 0,2010 | 0,0091 | 1,61 | 0,2297 | 0,0073 | 1,61 | 0,2297 | 0,0114 |
| S16- | Bludenz Montafon | Bings | 0,38 | 0,0680 | 0,0012 | 0,38 | 0,0680 | 0,0019 | 0,53 | 0,0951 | 0,0027 | 0,53 | 0,0951 | 0,0043 | 0,76 | 0,1087 | 0,0034 | 0,76 | 0,1087 | 0,0054 |
| S31- | Eisenstadt Süd | Eisenstadt Ost | 0,69 | 0,1232 | 0,0022 | 0,69 | 0,1232 | 0,0034 | 0,96 | 0,1724 | 0,0050 | 0,97 | 0,1724 | 0,0078 | 1,38 | 0,1971 | 0,0063 | 1,39 | 0,1971 | 0,0098 |
| S31- | Eisenstadt Mitte | Eisenstadt Süd | 0,26 | 0,0461 | 0,0008 | 0,26 | 0,0461 | 0,0013 | 0,36 | 0,0646 | 0,0019 | 0,36 | 0,0646 | 0,0029 | 0,52 | 0,0738 | 0,0023 | 0,52 | 0,0738 | 0,0037 |
| S31- | KN Eisenstadt | Eisenstadt Mitte | 0,42 | 0,0761 | 0,0013 | 0,42 | 0,0761 | 0,0021 | 0,59 | 0,1065 | 0,0031 | 0,60 | 0,1065 | 0,0048 | 0,85 | 0,1217 | 0,0039 | 0,86 | 0,1217 | 0,0061 |
| S31- | Wulkaprodersdorf | KN Eisenstadt | 0,56 | 0,1013 | 0,0018 | 0,57 | 0,1013 | 0,0028 | 0,79 | 0,1418 | 0,0041 | 0,79 | 0,1418 | 0,0064 | 1,14 | 0,1620 | 0,0051 | 1,14 | 0,1620 | 0,0081 |
| S31- | KN Mattersburg | Wulkaprodersdorf | 1,60 | 0,2875 | 0,0050 | 1,61 | 0,2875 | 0,0079 | 2,25 | 0,4025 | 0,0116 | 2,25 | 0,4025 | 0,0182 | 3,22 | 0,4600 | 0,0146 | 3,23 | 0,4600 | 0,0229 |
| S31- | Forchtenstein | KN Mattersburg | 1,16 | 0,2081 | 0,0036 | 1,16 | 0,2081 | 0,0057 | 1,63 | 0,2914 | 0,0084 | 1,63 | 0,2914 | 0,0132 | 2,33 | 0,3330 | 0,0106 | 2,34 | 0,3330 | 0,0166 |
| S31- | Sieggraben | Forchtenstein | 1,62 | 0,2908 | 0,0051 | 1,62 | 0,2908 | 0,0080 | 2,27 | 0,4071 | 0,0117 | 2,28 | 0,4071 | 0,0184 | 3,26 | 0,4653 | 0,0148 | 3,27 | 0,4653 | 0,0232 |
| S31- | Weppersdorf/Kobersdorf | Sieggraben | 1,95 | 0,3503 | 0,0061 | 1,96 | 0,3503 | 0,0096 | 2,74 | 0,4904 | 0,0141 | 2,75 | 0,4904 | 0,0222 | 3,93 | 0,5605 | 0,0178 | 3,94 | 0,5605 | 0,0279 |
| S31- | Weppersdorf/Markt St.Martin | Weppersdorf/Kobersdorf | 0,40 | 0,0720 | 0,0013 | 0,40 | 0,0720 | 0,0020 | 0,56 | 0,1007 | 0,0029 | 0,56 | 0,1007 | 0,0046 | 0,81 | 0,1151 | 0,0037 | 0,81 | 0,1151 | 0,0057 |
| S31- | Neutal | Weppersdorf/Markt St.Martin | 0,93 | 0,1663 | 0,0029 | 0,93 | 0,1663 | 0,0046 | 1,30 | 0,2328 | 0,0067 | 1,30 | 0,2328 | 0,0105 | 1,87 | 0,2660 | 0,0084 | 1,87 | 0,2660 | 0,0133 |
| S31- | Stoob Süd | Neutal | 0,81 | 0,1453 | 0,0025 | 0,81 | 0,1453 | 0,0040 | 1,14 | 0,2034 | 0,0058 | 1,14 | 0,2034 | 0,0092 | 1,63 | 0,2324 | 0,0074 | 1,63 | 0,2324 | 0,0116 |
| S31- | Oberpullendorf | Stoob Süd | 0,88 | 0,1586 | 0,0028 | 0,89 | 0,1586 | 0,0044 | 1,24 | 0,2220 | 0,0064 | 1,24 | 0,2220 | 0,0100 | 1,78 | 0,2538 | 0,0080 | 1,78 | 0,2538 | 0,0126 |
| S33- | St. Pölten Ost | KN St. Pölten | 0,48 | 0,0861 | 0,0015 | 0,48 | 0,0861 | 0,0024 | 0,67 | 0,1205 | 0,0035 | 0,67 | 0,1205 | 0,0054 | 0,97 | 0,1377 | 0,0044 | 0,97 | 0,1377 | 0,0069 |
| S33- | St. Pölten Nord | St. Pölten Ost | 0,85 | 0,1521 | 0,0027 | 0,85 | 0,1521 | 0,0042 | 1,19 | 0,2130 | 0,0061 | 1,19 | 0,2130 | 0,0096 | 1,71 | 0,2434 | 0,0077 | 1,71 | 0,2434 | 0,0121 |
| S33- | Herzogenburg Süd | St. Pölten Nord | 0,90 | 0,1611 | 0,0028 | 0,90 | 0,1611 | 0,0044 | 1,26 | 0,2255 | 0,0065 | 1,26 | 0,2255 | 0,0102 | 1,81 | 0,2577 | 0,0082 | 1,81 | 0,2577 | 0,0128 |
| S33- | Herzogenburg Stadt | Herzogenburg Süd | 0,48 | 0,0860 | 0,0015 | 0,48 | 0,0860 | 0,0024 | 0,67 | 0,1204 | 0,0035 | 0,67 | 0,1204 | 0,0054 | 0,96 | 0,1376 | 0,0044 | 0,97 | 0,1376 | 0,0069 |
| S33- | Herzogenburg Nord | Herzogenburg Stadt | 0,27 | 0,0477 | 0,0008 | 0,27 | 0,0477 | 0,0013 | 0,37 | 0,0668 | 0,0019 | 0,37 | 0,0668 | 0,0030 | 0,53 | 0,0763 | 0,0024 | 0,54 | 0,0763 | 0,0038 |
| S33- | Traismauer Süd | Herzogenburg Nord | 1,29 | 0,2320 | 0,0041 | 1,30 | 0,2320 | 0,0064 | 1,81 | | | | | | | | | | | |

| | | | | | | | | | | | | | | | | | | | | |
|------|--------------------------|--------------------------|------|--------|--------|------|--------|--------|------|--------|--------|------|--------|--------|------|--------|--------|------|--------|--------|
| S36- | Zeltweg Ost Spielberg | Knittelfeld West | 0,21 | 0,0370 | 0,0006 | 0,21 | 0,0370 | 0,0010 | 0,29 | 0,0518 | 0,0015 | 0,29 | 0,0518 | 0,0023 | 0,42 | 0,0592 | 0,0019 | 0,42 | 0,0592 | 0,0030 |
| S36- | Zeltweg West | Zeltweg Ost Spielberg | 1,34 | 0,2408 | 0,0042 | 1,34 | 0,2408 | 0,0066 | 1,88 | 0,3371 | 0,0097 | 1,89 | 0,3371 | 0,0152 | 2,70 | 0,3853 | 0,0122 | 2,71 | 0,3853 | 0,0192 |
| S36- | Judenburg Ost Fohnsdorf | Zeltweg West | 0,67 | 0,1211 | 0,0021 | 0,68 | 0,1211 | 0,0033 | 0,95 | 0,1695 | 0,0049 | 0,95 | 0,1695 | 0,0077 | 1,36 | 0,1937 | 0,0061 | 1,36 | 0,1937 | 0,0097 |
| S36- | Judenburg West | Judenburg Ost Fohnsdorf | 1,05 | 0,1878 | 0,0033 | 1,05 | 0,1878 | 0,0052 | 1,47 | 0,2630 | 0,0076 | 1,47 | 0,2630 | 0,0119 | 2,11 | 0,3005 | 0,0095 | 2,11 | 0,3005 | 0,0150 |
| S36- | St. Georgen Ost | As B317 (prov.) | 0,11 | 0,0196 | 0,0003 | 0,11 | 0,0196 | 0,0005 | 0,15 | 0,0275 | 0,0008 | 0,15 | 0,0275 | 0,0012 | 0,22 | 0,0314 | 0,0010 | 0,22 | 0,0314 | 0,0016 |
| S36- | St. Georgen West | St. Georgen Ost | 0,20 | 0,0364 | 0,0006 | 0,20 | 0,0364 | 0,0010 | 0,28 | 0,0509 | 0,0015 | 0,29 | 0,0509 | 0,0023 | 0,41 | 0,0582 | 0,0018 | 0,41 | 0,0582 | 0,0029 |
| S37- | St. Veit Mitte / Brückl | St. Veit Nord | 0,63 | 0,1139 | 0,0020 | 0,64 | 0,1139 | 0,0031 | 0,89 | 0,1595 | 0,0046 | 0,89 | 0,1595 | 0,0072 | 1,28 | 0,1823 | 0,0058 | 1,28 | 0,1823 | 0,0091 |
| S37- | St. Veit Süd | St. Veit Mitte / Brückl | 0,54 | 0,0968 | 0,0017 | 0,54 | 0,0968 | 0,0027 | 0,76 | 0,1356 | 0,0039 | 0,76 | 0,1356 | 0,0061 | 1,09 | 0,1549 | 0,0049 | 1,09 | 0,1549 | 0,0077 |
| S37- | St. Veit Industriegebiet | St. Veit Süd | 0,41 | 0,0728 | 0,0013 | 0,41 | 0,0728 | 0,0020 | 0,57 | 0,1019 | 0,0029 | 0,57 | 0,1019 | 0,0046 | 0,82 | 0,1165 | 0,0037 | 0,82 | 0,1165 | 0,0058 |
| S37- | Maria Saal | St. Veit Industriegebiet | 1,42 | 0,2555 | 0,0045 | 1,43 | 0,2555 | 0,0070 | 2,00 | 0,3577 | 0,0103 | 2,00 | 0,3577 | 0,0162 | 2,87 | 0,4088 | 0,0130 | 2,87 | 0,4088 | 0,0204 |
| S37- | Karnburg | Maria Saal | 0,51 | 0,0912 | 0,0016 | 0,51 | 0,0912 | 0,0025 | 0,71 | 0,1277 | 0,0037 | 0,72 | 0,1277 | 0,0058 | 1,02 | 0,1460 | 0,0046 | 1,03 | 0,1460 | 0,0073 |
| S37- | Klagenfurt Nord | Karnburg | 0,44 | 0,0796 | 0,0014 | 0,44 | 0,0796 | 0,0022 | 0,62 | 0,1115 | 0,0032 | 0,62 | 0,1115 | 0,0050 | 0,89 | 0,1274 | 0,0040 | 0,90 | 0,1274 | 0,0064 |

| Road | Toll road section from | Toll road section to | EURO III Cat 2 | | | | | | EURO III Cat 3 | | | | | | EURO III Cat 4 | | | | | |
|------|----------------------------|----------------------------|----------------|--------|--------|------------|--------|--------|----------------|--------|--------|------------|--------|--------|----------------|--------|--------|------|--------|--------|
| | | | Unit Price | | | Unit Price | | | Unit Price | | | Unit Price | | | Unit Price | | | | | |
| | | | Day | | Night | Day | | Night | Day | | Night | Day | | Night | Day | | Night | | | |
| Sum | Air | Noise | Sum | Air | Noise | Sum | Air | Noise | Sum | Air | Noise | Sum | Air | Noise | Sum | Air | Noise | | | |
| A01- | Wien Auhof | Preßbaum | 3,11 | 0,5572 | 0,0098 | 3,11 | 0,5572 | 0,0153 | 4,36 | 0,7801 | 0,0224 | 4,37 | 0,7801 | 0,0352 | 6,25 | 0,8915 | 0,0283 | 6,27 | 0,8915 | 0,0444 |
| A01- | Preßbaum | KN Steinhäusl | 1,75 | 0,3149 | 0,0055 | 1,76 | 0,3149 | 0,0087 | 2,46 | 0,4408 | 0,0127 | 2,47 | 0,4408 | 0,0199 | 3,53 | 0,5038 | 0,0160 | 3,54 | 0,5038 | 0,0251 |
| A01- | KN Steinhäusl | Altlangbach | 1,03 | 0,1851 | 0,0032 | 1,03 | 0,1851 | 0,0051 | 1,45 | 0,2592 | 0,0075 | 1,45 | 0,2592 | 0,0117 | 2,08 | 0,2962 | 0,0094 | 2,08 | 0,2962 | 0,0148 |
| A01- | Altlangbach | St. Christoph | 1,23 | 0,2208 | 0,0039 | 1,23 | 0,2208 | 0,0061 | 1,73 | 0,3091 | 0,0089 | 1,73 | 0,3091 | 0,0140 | 2,48 | 0,3532 | 0,0112 | 2,48 | 0,3532 | 0,0176 |
| A01- | St. Christoph | Böheimkirchen | 1,48 | 0,2648 | 0,0046 | 1,48 | 0,2648 | 0,0073 | 2,07 | 0,3707 | 0,0107 | 2,08 | 0,3707 | 0,0167 | 2,97 | 0,4236 | 0,0134 | 2,98 | 0,4236 | 0,0211 |
| A01- | Böheimkirchen | KN St. Pölten | 1,44 | 0,2590 | 0,0045 | 1,45 | 0,2590 | 0,0071 | 2,02 | 0,3626 | 0,0104 | 2,03 | 0,3626 | 0,0164 | 2,91 | 0,4144 | 0,0131 | 2,91 | 0,4144 | 0,0207 |
| A01- | KN St. Pölten | St. Pölten Süd | 1,02 | 0,1837 | 0,0032 | 1,03 | 0,1837 | 0,0051 | 1,44 | 0,2572 | 0,0074 | 1,44 | 0,2572 | 0,0116 | 2,06 | 0,2940 | 0,0093 | 2,07 | 0,2940 | 0,0147 |
| A01- | St. Pölten Süd | Loosdorf | 3,55 | 0,6371 | 0,0111 | 3,56 | 0,6371 | 0,0175 | 4,98 | 0,8920 | 0,0256 | 5,00 | 0,8920 | 0,0403 | 7,15 | 1,0194 | 0,0323 | 7,16 | 1,0194 | 0,0508 |
| A01- | Loosdorf | Melk | 1,30 | 0,2334 | 0,0041 | 1,30 | 0,2334 | 0,0064 | 1,82 | 0,3268 | 0,0094 | 1,83 | 0,3268 | 0,0148 | 2,62 | 0,3735 | 0,0118 | 2,63 | 0,3735 | 0,0186 |
| A01- | Melk | Pöchlarn | 2,31 | 0,4138 | 0,0072 | 2,31 | 0,4138 | 0,0114 | 3,24 | 0,5794 | 0,0167 | 3,24 | 0,5794 | 0,0262 | 4,64 | 0,6621 | 0,0210 | 4,65 | 0,6621 | 0,0330 |
| A01- | Pöchlarn | Ybbs Wieselburg | 2,13 | 0,3819 | 0,0067 | 2,13 | 0,3819 | 0,0105 | 2,99 | 0,5346 | 0,0154 | 2,99 | 0,5346 | 0,0242 | 4,28 | 0,6110 | 0,0194 | 4,29 | 0,6110 | 0,0305 |
| A01- | Ybbs Wieselburg | Amstetten Ost | 1,91 | 0,3432 | 0,0060 | 1,92 | 0,3432 | 0,0094 | 2,68 | 0,4804 | 0,0138 | 2,69 | 0,4804 | 0,0217 | 3,85 | 0,5491 | 0,0174 | 3,86 | 0,5491 | 0,0274 |
| A01- | Amstetten Ost | Amstetten West | 3,01 | 0,5398 | 0,0094 | 3,01 | 0,5398 | 0,0148 | 4,22 | 0,7557 | 0,0217 | 4,23 | 0,7557 | 0,0341 | 6,05 | 0,8636 | 0,0274 | 6,07 | 0,8636 | 0,0430 |
| A01- | Amstetten West | Oed | 2,11 | 0,3790 | 0,0066 | 2,12 | 0,3790 | 0,0104 | 2,96 | 0,5305 | 0,0153 | 2,97 | 0,5305 | 0,0240 | 4,25 | 0,6063 | 0,0192 | 4,26 | 0,6063 | 0,0302 |
| A01- | Oed | Haag | 2,28 | 0,4090 | 0,0072 | 2,28 | 0,4090 | 0,0112 | 3,20 | 0,5726 | 0,0165 | 3,21 | 0,5726 | 0,0259 | 4,59 | 0,6544 | 0,0208 | 4,60 | 0,6544 | 0,0326 |
| A01- | Haag | St. Valentin | 2,03 | 0,3642 | 0,0064 | 2,03 | 0,3642 | 0,0100 | 2,85 | 0,5099 | 0,0147 | 2,86 | 0,5099 | 0,0230 | 4,09 | 0,5827 | 0,0185 | 4,10 | 0,5827 | 0,0290 |
| A01- | St. Valentin | Enns Steyr | 0,86 | 0,1544 | 0,0027 | 0,86 | 0,1544 | 0,0042 | 1,21 | 0,2162 | 0,0062 | 1,21 | 0,2162 | 0,0098 | 1,73 | 0,2470 | 0,0078 | 1,74 | 0,2470 | 0,0123 |
| A01- | Enns Steyr | Enns West | 0,67 | 0,1198 | 0,0021 | 0,67 | 0,1198 | 0,0033 | 0,94 | 0,1677 | 0,0048 | 0,94 | 0,1677 | 0,0076 | 1,34 | 0,1916 | 0,0061 | 1,35 | 0,1916 | 0,0096 |
| A01- | Enns West | Asten St Florian | 0,52 | 0,0930 | 0,0016 | 0,52 | 0,0930 | 0,0026 | 0,73 | 0,1302 | 0,0037 | 0,73 | 0,1302 | 0,0059 | 1,04 | 0,1488 | 0,0047 | 1,05 | 0,1488 | 0,0074 |
| A01- | Asten St Florian | KN Linz | 1,98 | 0,3562 | 0,0062 | 1,99 | 0,3562 | 0,0098 | 2,78 | 0,4986 | 0,0143 | 2,79 | 0,4986 | 0,0225 | 3,99 | 0,5699 | 0,0181 | 4,01 | 0,5699 | 0,0284 |
| A01- | KN Linz | Ansfelden | 0,33 | 0,0600 | 0,0011 | 0,34 | 0,0600 | 0,0017 | 0,47 | 0,0841 | 0,0024 | 0,47 | 0,0841 | 0,0038 | 0,67 | 0,0961 | 0,0030 | 0,68 | 0,0961 | 0,0048 |
| A01- | Ansfelden | Traun | 0,74 | 0,1329 | 0,0023 | 0,74 | 0,1329 | 0,0037 | 1,04 | 0,1860 | 0,0053 | 1,04 | 0,1860 | 0,0084 | 1,49 | 0,2126 | 0,0067 | 1,49 | 0,2126 | 0,0106 |
| A01- | Traun | KN A1/A25 Passau Wels | 0,35 | 0,0625 | 0,0011 | 0,35 | 0,0625 | 0,0017 | 0,49 | 0,0875 | 0,0025 | 0,49 | 0,0875 | 0,0040 | 0,70 | 0,1000 | 0,0032 | 0,70 | 0,1000 | 0,0050 |
| A01- | KN A1/A25 Passau Wels | Allhaming | 1,61 | 0,2883 | 0,0050 | 1,61 | 0,2883 | 0,0079 | 2,25 | 0,4036 | 0,0116 | 2,26 | 0,4036 | 0,0182 | 3,23 | 0,4612 | 0,0146 | 3,24 | 0,4612 | 0,0230 |
| A01- | Allhaming | Sattledt | 2,68 | 0,4810 | 0,0084 | 2,69 | 0,4810 | 0,0132 | 3,76 | 0,6733 | 0,0194 | 3,77 | 0,6733 | 0,0304 | 5,39 | 0,7695 | 0,0244 | 5,41 | 0,7695 | 0,0384 |
| A01- | Sattledt | KN Voralpenkreuz | 0,34 | 0,0605 | 0,0011 | 0,34 | 0,0605 | 0,0017 | 0,47 | 0,0847 | 0,0024 | 0,47 | 0,0847 | 0,0038 | 0,68 | 0,0968 | 0,0031 | 0,68 | 0,0968 | 0,0048 |
| A01- | KN Voralpenkreuz | Eberstalzell | 0,97 | 0,1741 | 0,0030 | 0,97 | 0,1741 | 0,0048 | 1,36 | 0,2438 | 0,0070 | 1,37 | 0,2438 | 0,0110 | 1,95 | 0,2786 | 0,0088 | 1,96 | 0,2786 | 0,0139 |
| A01- | Eberstalzell | Vorchdorf | 1,46 | 0,2626 | 0,0046 | 1,47 | 0,2626 | 0,0072 | 2,05 | 0,3676 | 0,0106 | 2,06 | 0,3676 | 0,0166 | 2,94 | 0,4201 | 0,0133 | 2,95 | 0,4201 | 0,0209 |
| A01- | Vorchdorf | Laakirchen Ost | 1,28 | 0,2300 | 0,0040 | 1,28 | 0,2300 | 0,0063 | 1,80 | 0,3221 | 0,0093 | 1,80 | 0,3221 | 0,0146 | 2,58 | 0,3681 | 0,0117 | 2,59 | 0,3681 | 0,0183 |
| A01- | Laakirchen Ost | Laakirchen West | 0,81 | 0,1448 | 0,0025 | 0,81 | 0,1448 | 0,0040 | 1,13 | 0,2027 | 0,0058 | 1,14 | 0,2027 | 0,0092 | 1,62 | 0,2317 | 0,0073 | 1,63 | 0,2317 | 0,0115 |
| A01- | Laakirchen West | Regau | 1,58 | 0,2838 | 0,0050 | 1,58 | 0,2838 | 0,0078 | 2,22 | 0,3974 | 0,0114 | 2,23 | 0,3974 | 0,0180 | 3,18 | 0,4541 | 0,0144 | 3,19 | 0,4541 | 0,0226 |
| A01- | Regau | Schörfling | 2,08 | 0,3730 | 0,0065 | 2,08 | 0,3730 | 0,0103 | 2,92 | 0,5221 | 0,0150 | 2,92 | 0,5221 | 0,0236 | 4,18 | 0,5967 | 0,0189 | 4,19 | 0,5967 | 0,0297 |
| A01- | Schörfling | Seewalchen | 0,32 | 0,0578 | 0,0010 | 0,32 | 0,0578 | 0,0016 | 0,45 | 0,0809 | 0,0023 | 0,45 | 0,0809 | 0,0037 | 0,65 | 0,0925 | 0,0029 | 0,65 | 0,0925 | 0,0046 |
| A01- | Seewalchen | St. Georgen | 1,88 | 0,3381 | 0,0059 | 1,89 | 0,3381 | 0,0093 | 2,64 | 0,4733 | 0,0136 | 2,65 | 0,4733 | 0,0214 | 3,79 | 0,5409 | 0,0172 | 3,80 | 0,5409 | 0,0270 |
| A01- | St. Georgen | Oberwang | 2,51 | 0,4508 | 0,0079 | 2,52 | 0,4508 | 0,0124 | 3,52 | 0,6311 | 0,0181 | 3,53 | 0,6311 | 0,0285 | 5,06 | 0,7213 | 0,0229 | 5,07 | 0,7213 | 0,0360 |
| A01- | Oberwang | Mondsee | 2,31 | 0,4149 | 0,0073 | 2,32 | 0,4149 | 0,0114 | 3,24 | 0,5809 | 0,0167 | 3,25 | 0,5809 | 0,0262 | 4,65 | 0,6639 | 0,0211 | 4,67 | 0,6639 | 0,0331 |
| A01- | Mondsee | Thalgau | 2,13 | 0,3825 | 0,0067 | 2,14 | 0,3825 | 0,0105 | 2,99 | 0,5355 | 0,0154 | 3,00 | 0,5355 | 0,0242 | 4,29 | 0,6120 | 0,0194 | 4,30 | 0,6120 | 0,0305 |
| A01- | Thalgau | Wallersee | 1,62 | 0,2915 | 0,0051 | 1,63 | 0,2915 | 0,0080 | 2,28 | 0,4081 | 0,0117 | 2,29 | 0,4081 | 0,0184 | 3,27 | 0,4664 | 0,0148 | 3,28 | 0,4664 | 0,0232 |
| A01- | Wallersee | Salzburg Nord | 1,57 | 0,2822 | 0,0049 | 1,58 | 0,2822 | 0,0078 | 2,21 | 0,3950 | 0,0114 | 2,21 | 0,3950 | 0,0178 | 3,16 | 0,4515 | 0,0143 | 3,17 | 0,4515 | 0,0225 |
| A01- | Salzburg Nord | Salzburg Bergheim-West | 0,35 | 0,0636 | 0,0011 | 0,36 | 0,0636 | 0,0017 | 0,50 | 0,0890 | 0,0026 | 0,50 | 0,0890 | 0,0040 | 0,71 | 0,1018 | 0,0032 | 0,72 | 0,1018 | 0,0051 |
| A01- | Salzburg Bergheim-West | Messe | 0,17 | 0,0304 | 0,0005 | 0,17 | 0,0304 | 0,0008 | 0,24 | 0,0426 | 0,0012 | 0,24 | 0,0426 | 0,0019 | 0,34 | 0,0487 | 0,0015 | 0,34 | 0,0487 | 0,0024 |
| A01- | Messe | Salzburg Mitte Freilassing | 0,23 | 0,0405 | 0,0007 | 0,23 | 0,0405 | 0,0011 | 0,32 | 0,0567 | 0,0016 | 0,32 | 0,0567 | 0,0026 | 0,45 | 0,0648 | 0,0021 | 0,46 | 0,0648 | 0,0032 |
| A01- | Salzburg Mitte Freilassing | Kleßheim | 0,28 | 0,0497 | 0,0009 | 0,28 | 0,0497 | 0,0014 | 0,39 | 0,0696 | 0,0020 | 0,39 | 0,0696 | 0,0031 | 0,56 | 0,0796 | 0,0025 | 0,56 | 0,0796 | 0,0040 |
| A01- | Kleßheim | Siezenheim | 0,38 | 0,0689 | 0,0012 | 0,38 | 0,0689 | 0,0019 | 0,54 | 0,0965 | 0,0028 | 0,54 | 0,0965 | 0,0044 | 0,77 | 0,1103 | 0,0035 | 0,78 | 0,1103 | 0,0055 |
| A01- | Siezenheim | Flughafen | 0,19 | 0,0346 | 0,0006 | 0,19 | 0,0346 | 0,0010 | 0,27 | 0,0485 | 0,0014 | 0,27 | 0,0485 | 0,0022 | 0,39 | 0,0554 | 0,0018 | 0,39 | 0,0554 | 0,0028 |
| A01- | Flughafen | Wals Salzburg West | 0,24 | 0,0424 | 0,0007 | 0,24 | 0,0424 | 0,0012 | 0,33 | 0,0593 | 0,0017 | 0,33 | 0,0593 | 0,0027 | 0,48 | 0,0678 | 0,0021 | 0,48 | 0,0678 | 0,0034 |
| A01- | Wals Salzburg West | KN Salzburg | 0,35 | 0,0634 | 0,0011 | 0,35 | 0,0634 | 0,0017 | 0,50 | 0,0888 | 0,0026 | 0,50 | 0,0888 | 0,0040 | 0,71 | 0,1014 | 0,0032 | 0,71 | 0,1014 | 0,0051 |
| A01- | KN Salzburg | Staatsgrenze Walsberg | 0,60 | 0,1077 | 0,0019 | 0,60 | 0,1077 | 0,0030 | 0,84 | 0,1508 | 0,0043 | 0,84 | 0,1508 | 0,0068 | 1,21 | 0,1724 | 0,0055 | 1,21 | 0,1724 | 0,0086 |
| A02- | KN Wien Inzersdorf | KN Vösendorf | 0,75 | 0,1348 | 0,0024 | 0,75 | 0,1348 | 0,0037 | 1,05 | 0,1887 | 0,0054 | 1,06 | 0,1887 | 0,0085 | 1,51 | 0,2157 | 0,0068 | 1,52 | 0,2157 | 0,0108 |
| A02- | KN Vösendorf | Mödling | 0,51 | 0,0916 | 0,0016 | 0,51 | 0,0916 | 0,0025 | 0,72 | 0,1283 | 0,0037 | 0,72 | 0 | | | | | | | |

| | | | | | | | | | | | | | | | | | | | | |
|------|----------------------------|---------------------------------------|------|--------|--------|------|--------|--------|------|--------|--------|------|--------|--------|------|--------|--------|------|--------|--------|
| A02- | Ilz Fürstenfeld | Sinabelkirchen | 2,50 | 0,4493 | 0,0079 | 2,51 | 0,4493 | 0,0124 | 3,51 | 0,6290 | 0,0181 | 3,52 | 0,6290 | 0,0284 | 5,04 | 0,7189 | 0,0228 | 5,05 | 0,7189 | 0,0358 |
| A02- | Sinabelkirchen | Gleisdorf Süd | 1,65 | 0,2960 | 0,0052 | 1,65 | 0,2960 | 0,0081 | 2,31 | 0,4144 | 0,0119 | 2,32 | 0,4144 | 0,0187 | 3,32 | 0,4736 | 0,0150 | 3,33 | 0,4736 | 0,0236 |
| A02- | Gleisdorf Süd | Gleisdorf West | 0,72 | 0,1285 | 0,0022 | 0,72 | 0,1285 | 0,0035 | 1,00 | 0,1799 | 0,0052 | 1,01 | 0,1799 | 0,0081 | 1,44 | 0,2056 | 0,0065 | 1,44 | 0,2056 | 0,0102 |
| A02- | Gleisdorf West | Laßnitzhöhe | 1,88 | 0,3366 | 0,0059 | 1,88 | 0,3366 | 0,0093 | 2,63 | 0,4713 | 0,0135 | 2,64 | 0,4713 | 0,0213 | 3,78 | 0,5386 | 0,0171 | 3,79 | 0,5386 | 0,0268 |
| A02- | Laßnitzhöhe | KN Graz Ost | 2,35 | 0,4212 | 0,0074 | 2,35 | 0,4212 | 0,0116 | 3,29 | 0,5896 | 0,0170 | 3,30 | 0,5896 | 0,0266 | 4,72 | 0,6739 | 0,0214 | 4,74 | 0,6739 | 0,0336 |
| A02- | KN Graz Ost | Graz Feldkirchen Flughafen | 0,84 | 0,1515 | 0,0027 | 0,85 | 0,1515 | 0,0042 | 1,18 | 0,2121 | 0,0061 | 1,19 | 0,2121 | 0,0096 | 1,70 | 0,2424 | 0,0077 | 1,70 | 0,2424 | 0,0121 |
| A02- | Graz Feldkirchen Flughafen | KN Graz West | 0,57 | 0,1014 | 0,0018 | 0,57 | 0,1014 | 0,0028 | 0,79 | 0,1420 | 0,0041 | 0,80 | 0,1420 | 0,0064 | 1,14 | 0,1623 | 0,0051 | 1,14 | 0,1623 | 0,0081 |
| A02- | KN Graz West | Unterpremstätten | 0,68 | 0,1220 | 0,0021 | 0,68 | 0,1220 | 0,0034 | 0,95 | 0,1707 | 0,0049 | 0,96 | 0,1707 | 0,0077 | 1,37 | 0,1951 | 0,0062 | 1,37 | 0,1951 | 0,0097 |
| A02- | Unterpremstätten | Lieboch | 1,06 | 0,1894 | 0,0033 | 1,06 | 0,1894 | 0,0052 | 1,48 | 0,2652 | 0,0076 | 1,49 | 0,2652 | 0,0120 | 2,12 | 0,3030 | 0,0096 | 2,13 | 0,3030 | 0,0151 |
| A02- | Lieboch | Mooskirchen | 1,46 | 0,2612 | 0,0046 | 1,46 | 0,2612 | 0,0072 | 2,04 | 0,3656 | 0,0105 | 2,05 | 0,3656 | 0,0165 | 2,93 | 0,4179 | 0,0133 | 2,94 | 0,4179 | 0,0208 |
| A02- | Mooskirchen | Steinberg | 1,51 | 0,2703 | 0,0047 | 1,51 | 0,2703 | 0,0074 | 2,11 | 0,3784 | 0,0109 | 2,12 | 0,3784 | 0,0171 | 3,03 | 0,4324 | 0,0137 | 3,04 | 0,4324 | 0,0216 |
| A02- | Steinberg | Modriach | 3,76 | 0,6756 | 0,0118 | 3,77 | 0,6756 | 0,0186 | 5,28 | 0,9458 | 0,0272 | 5,30 | 0,9458 | 0,0427 | 7,58 | 1,0810 | 0,0343 | 7,60 | 1,0810 | 0,0539 |
| A022 | KN Graz Ost | Puchwerk | 0,16 | 0,0283 | 0,0005 | 0,16 | 0,0283 | 0,0008 | 0,22 | 0,0396 | 0,0011 | 0,22 | 0,0396 | 0,0018 | 0,32 | 0,0453 | 0,0014 | 0,32 | 0,0453 | 0,0023 |
| A022 | Puchwerk | Graz Raaba | 0,23 | 0,0405 | 0,0007 | 0,23 | 0,0405 | 0,0011 | 0,32 | 0,0567 | 0,0016 | 0,32 | 0,0567 | 0,0026 | 0,45 | 0,0648 | 0,0021 | 0,46 | 0,0648 | 0,0032 |
| A022 | Graz Raaba | Graz Sternäckerweg | 0,33 | 0,0588 | 0,0010 | 0,33 | 0,0588 | 0,0016 | 0,46 | 0,0824 | 0,0024 | 0,46 | 0,0824 | 0,0037 | 0,66 | 0,0941 | 0,0030 | 0,66 | 0,0941 | 0,0047 |
| A02- | Modriach | Packsattel | 1,73 | 0,3112 | 0,0054 | 1,74 | 0,3112 | 0,0086 | 2,43 | 0,4356 | 0,0125 | 2,44 | 0,4356 | 0,0197 | 3,49 | 0,4979 | 0,0158 | 3,50 | 0,4979 | 0,0248 |
| A02- | Packsattel | Bad St. Leonhard | 2,11 | 0,3784 | 0,0066 | 2,11 | 0,3784 | 0,0104 | 2,96 | 0,5297 | 0,0152 | 2,97 | 0,5297 | 0,0239 | 4,24 | 0,6054 | 0,0192 | 4,25 | 0,6054 | 0,0302 |
| A02- | Bad St. Leonhard | Wolfsberg Nord | 2,48 | 0,4446 | 0,0078 | 2,48 | 0,4446 | 0,0122 | 3,48 | 0,6225 | 0,0179 | 3,49 | 0,6225 | 0,0281 | 4,99 | 0,7114 | 0,0226 | 5,00 | 0,7114 | 0,0355 |
| A02- | Wolfsberg Nord | Wolfsberg Süd | 0,70 | 0,1264 | 0,0022 | 0,71 | 0,1264 | 0,0035 | 0,99 | 0,1770 | 0,0051 | 0,99 | 0,1770 | 0,0080 | 1,42 | 0,2022 | 0,0064 | 1,42 | 0,2022 | 0,0101 |
| A02- | Wolfsberg Süd | St. Andrä | 2,07 | 0,3714 | 0,0065 | 2,07 | 0,3714 | 0,0102 | 2,90 | 0,5200 | 0,0149 | 2,91 | 0,5200 | 0,0235 | 4,17 | 0,5942 | 0,0188 | 4,18 | 0,5942 | 0,0296 |
| A02- | St. Andrä | Griffen | 2,01 | 0,3610 | 0,0063 | 2,02 | 0,3610 | 0,0099 | 2,82 | 0,5054 | 0,0145 | 2,83 | 0,5054 | 0,0228 | 4,05 | 0,5776 | 0,0183 | 4,06 | 0,5776 | 0,0288 |
| A02- | Griffen | Völkermarkt Ost | 1,02 | 0,1824 | 0,0032 | 1,02 | 0,1824 | 0,0050 | 1,43 | 0,2553 | 0,0073 | 1,43 | 0,2553 | 0,0115 | 2,05 | 0,2918 | 0,0093 | 2,05 | 0,2918 | 0,0145 |
| A02- | Völkermarkt Ost | Völkermarkt West | 2,35 | 0,4208 | 0,0074 | 2,35 | 0,4208 | 0,0116 | 3,29 | 0,5892 | 0,0169 | 3,30 | 0,5892 | 0,0266 | 4,72 | 0,6733 | 0,0214 | 4,73 | 0,6733 | 0,0336 |
| A02- | Völkermarkt West | Grafenstein | 2,24 | 0,4028 | 0,0070 | 2,25 | 0,4028 | 0,0111 | 3,15 | 0,5640 | 0,0162 | 3,16 | 0,5640 | 0,0255 | 4,52 | 0,6445 | 0,0204 | 4,53 | 0,6445 | 0,0321 |
| A02- | Grafenstein | Klagenfurt Ost | 1,44 | 0,2584 | 0,0045 | 1,44 | 0,2584 | 0,0071 | 2,02 | 0,3618 | 0,0104 | 2,03 | 0,3618 | 0,0163 | 2,90 | 0,4134 | 0,0131 | 2,91 | 0,4134 | 0,0206 |
| A02- | Klagenfurt Ost | Klagenfurt Flughafen | 0,73 | 0,1307 | 0,0023 | 0,73 | 0,1307 | 0,0036 | 1,02 | 0,1830 | 0,0053 | 1,02 | 0,1830 | 0,0083 | 1,47 | 0,2092 | 0,0066 | 1,47 | 0,2092 | 0,0104 |
| A02- | Klagenfurt Flughafen | Klagenfurt Nord | 0,81 | 0,1448 | 0,0025 | 0,81 | 0,1448 | 0,0040 | 1,13 | 0,2027 | 0,0058 | 1,14 | 0,2027 | 0,0092 | 1,62 | 0,2317 | 0,0073 | 1,63 | 0,2317 | 0,0115 |
| A02- | Klagenfurt Nord | Klagenfurt West | 1,40 | 0,2504 | 0,0044 | 1,40 | 0,2504 | 0,0069 | 1,96 | 0,3505 | 0,0101 | 1,96 | 0,3505 | 0,0158 | 2,81 | 0,4006 | 0,0127 | 2,82 | 0,4006 | 0,0200 |
| A02- | Klagenfurt West | Krumpendorf West | 0,56 | 0,0998 | 0,0017 | 0,56 | 0,0998 | 0,0027 | 0,78 | 0,1397 | 0,0040 | 0,78 | 0,1397 | 0,0063 | 1,12 | 0,1597 | 0,0051 | 1,12 | 0,1597 | 0,0080 |
| A02- | Krumpendorf West | Pörschach Ost | 0,67 | 0,1202 | 0,0021 | 0,67 | 0,1202 | 0,0033 | 0,94 | 0,1683 | 0,0048 | 0,94 | 0,1683 | 0,0076 | 1,35 | 0,1923 | 0,0061 | 1,35 | 0,1923 | 0,0096 |
| A02- | Pörschach Ost | Pörschach West | 1,04 | 0,1872 | 0,0033 | 1,04 | 0,1872 | 0,0051 | 1,46 | 0,2620 | 0,0075 | 1,47 | 0,2620 | 0,0118 | 2,10 | 0,2995 | 0,0095 | 2,10 | 0,2995 | 0,0149 |
| A02- | Pörschach West | Velden Ost | 0,77 | 0,1387 | 0,0024 | 0,77 | 0,1387 | 0,0038 | 1,08 | 0,1942 | 0,0056 | 1,09 | 0,1942 | 0,0088 | 1,56 | 0,2219 | 0,0070 | 1,56 | 0,2219 | 0,0111 |
| A02- | Velden Ost | Velden West | 0,83 | 0,1493 | 0,0026 | 0,83 | 0,1493 | 0,0041 | 1,17 | 0,2090 | 0,0060 | 1,17 | 0,2090 | 0,0094 | 1,67 | 0,2389 | 0,0076 | 1,68 | 0,2389 | 0,0119 |
| A02- | Velden West | Wernberg | 1,38 | 0,2468 | 0,0043 | 1,38 | 0,2468 | 0,0068 | 1,93 | 0,3455 | 0,0099 | 1,93 | 0,3455 | 0,0156 | 2,77 | 0,3949 | 0,0125 | 2,78 | 0,3949 | 0,0197 |
| A02- | Wernberg | KN Villach | 0,73 | 0,1312 | 0,0023 | 0,73 | 0,1312 | 0,0036 | 1,03 | 0,1837 | 0,0053 | 1,03 | 0,1837 | 0,0083 | 1,47 | 0,2099 | 0,0067 | 1,48 | 0,2099 | 0,0105 |
| A02- | KN Villach | Villach Faaker See | 0,57 | 0,1020 | 0,0018 | 0,57 | 0,1020 | 0,0028 | 0,80 | 0,1428 | 0,0041 | 0,80 | 0,1428 | 0,0065 | 1,14 | 0,1632 | 0,0052 | 1,15 | 0,1632 | 0,0081 |
| A02- | Villach Faaker See | Villach Warmbad | 1,30 | 0,2330 | 0,0041 | 1,30 | 0,2330 | 0,0064 | 1,82 | 0,3262 | 0,0094 | 1,83 | 0,3262 | 0,0147 | 2,61 | 0,3728 | 0,0118 | 2,62 | 0,3728 | 0,0186 |
| A02- | Villach Warmbad | Hermagor | 2,35 | 0,4224 | 0,0074 | 2,36 | 0,4224 | 0,0116 | 3,30 | 0,5914 | 0,0170 | 3,31 | 0,5914 | 0,0267 | 4,74 | 0,6758 | 0,0214 | 4,75 | 0,6758 | 0,0337 |
| A02- | Hermagor | Arnoldstein | 0,56 | 0,1006 | 0,0018 | 0,56 | 0,1006 | 0,0028 | 0,79 | 0,1408 | 0,0040 | 0,79 | 0,1408 | 0,0064 | 1,13 | 0,1610 | 0,0051 | 1,13 | 0,1610 | 0,0080 |
| A02- | Arnoldstein | Staatsgrenze Arnoldstein | 0,86 | 0,1542 | 0,0027 | 0,86 | 0,1542 | 0,0042 | 1,21 | 0,2159 | 0,0062 | 1,21 | 0,2159 | 0,0098 | 1,73 | 0,2468 | 0,0078 | 1,73 | 0,2468 | 0,0123 |
| A03- | KN Guntramsdorf | Münchendorf/Achau | 0,22 | 0,0400 | 0,0007 | 0,22 | 0,0400 | 0,0011 | 0,31 | 0,0561 | 0,0016 | 0,31 | 0,0561 | 0,0025 | 0,45 | 0,0641 | 0,0020 | 0,45 | 0,0641 | 0,0032 |
| A03- | Münchendorf/Achau | Ebreichsdorf Nord | 0,94 | 0,1686 | 0,0029 | 0,94 | 0,1686 | 0,0046 | 1,32 | 0,2360 | 0,0068 | 1,32 | 0,2360 | 0,0107 | 1,89 | 0,2697 | 0,0086 | 1,90 | 0,2697 | 0,0134 |
| A03- | Ebreichsdorf Nord | Ebreichsdorf West | 0,77 | 0,1376 | 0,0024 | 0,77 | 0,1376 | 0,0038 | 1,08 | 0,1926 | 0,0055 | 1,08 | 0,1926 | 0,0087 | 1,54 | 0,2202 | 0,0070 | 1,55 | 0,2202 | 0,0110 |
| A03- | Ebreichsdorf West | Pottendorf | 1,01 | 0,1805 | 0,0032 | 1,01 | 0,1805 | 0,0050 | 1,41 | 0,2527 | 0,0073 | 1,42 | 0,2527 | 0,0114 | 2,02 | 0,2888 | 0,0092 | 2,03 | 0,2888 | 0,0144 |
| A03- | Pottendorf | Hornstein | 1,65 | 0,2964 | 0,0052 | 1,65 | 0,2964 | 0,0082 | 2,32 | 0,4150 | 0,0119 | 2,32 | 0,4150 | 0,0187 | 3,32 | 0,4742 | 0,0150 | 3,33 | 0,4742 | 0,0236 |
| A03- | Hornstein | Müllendorf | 1,08 | 0,1942 | 0,0034 | 1,08 | 0,1942 | 0,0053 | 1,52 | 0,2719 | 0,0078 | 1,52 | 0,2719 | 0,0123 | 2,18 | 0,3108 | 0,0099 | 2,18 | 0,3108 | 0,0155 |
| A03- | Müllendorf | KN Eisenstadt | 0,90 | 0,1624 | 0,0028 | 0,91 | 0,1624 | 0,0045 | 1,27 | 0,2273 | 0,0065 | 1,27 | 0,2273 | 0,0103 | 1,82 | 0,2598 | 0,0082 | 1,83 | 0,2598 | 0,0129 |
| A031 | KN Eisenstadt | Siegersdorf | 0,71 | 0,1280 | 0,0022 | 0,71 | 0,1280 | 0,0035 | 1,00 | 0,1792 | 0,0052 | 1,00 | 0,1792 | 0,0081 | 1,44 | 0,2048 | 0,0065 | 1,44 | 0,2048 | 0,0102 |
| A041 | Stadionbrücke | KN Wien Prater | 0,13 | 0,0235 | 0,0004 | 0,13 | 0,0235 | 0,0006 | 0,18 | 0,0329 | 0,0009 | 0,18 | 0,0329 | 0,0015 | 0,26 | 0,0376 | 0,0012 | 0,26 | 0,0376 | 0,0019 |
| A04- | KN Wien Prater | Alt-Simmering Wien 7. Haidequerstraße | 0,29 | 0,0512 | 0,0009 | 0,29 | 0,0512 | 0,0014 | 0,40 | 0,0717 | 0,0021 | 0,40 | 0,0717 | 0,0032 | 0,57 | 0,0820 | 0,0026 | 0,58 | 0,0820 | 0,0041 |
| A04- | Alt-Simmering | Wien 7. Haidequerstraße | 0,22 | 0,0387 | 0,0007 | 0,22 | 0,0387 | 0,0011 | 0,30 | 0,0542 | 0,0016 | 0,30 | 0,0542 | 0,0024 | 0,43 | 0,0619 | 0,0020 | 0,44 | 0,0619 | 0,0031 |
| A04- | Wien 7. Haidequerstraße | Wien Simmeringer Haide | 0,40 | 0,0723 | 0,0013 | 0,40 | 0,0723 | 0,0020 | 0,57 | 0,1012 | 0,0029 | 0,57 | 0,1012 | 0,0046 | 0,81 | 0,1156 | 0,0037 | 0,81 | 0,1156 | 0,0058 |
| A04- | Wien Simmeringer Haide | KN Schwechat | 0,81 | 0,1456 | 0,0025 | 0,81 | 0,1456 | 0,0040 | 1,14 | 0,2038 | 0,0059 | 1,14 | 0,2038 | 0,0092 | 1,63 | 0,2330 | 0,0074 | 1,64 | 0,2330 | 0,0116 |
| A04- | KN Schwechat | Flughafen Wien Schwechat | 1,17 | 0,2103 | 0,0037 | 1,17 | 0,2103 | 0,0058 | 1,64 | 0,2944 | 0,0085 | 1,65 | 0,2944 | 0,0133 | 2,36 | 0,3365 | 0,0107 | 2,37 | 0,3365 | 0,0168 |
| A04- | Flughafen Wien Schwechat | Fischamend | 1,31 | 0,2355 | 0,0041 | 1,31 | 0,2355 | 0,0065 | 1,84 | 0,3297 | 0,0095 | 1,85 | 0,3297 | 0,0149 | 2,64 | 0,3768 | 0,0120 | 2,65 | 0,3768 | 0,0188 |
| A04- | Fischamend | Bruck/Leitha West | 2,88 | 0,5164 | 0,0090 | 2,88 | 0,5164 | 0,0142 | 4,04 | 0,7230 | 0,0208 | 4,05 | 0,7230 | 0,0327 | 5,79 | 0,8263 | 0,0262 | 5,81 | 0,8263 | 0,0412 |
| A04- | Bruck/Leitha West | Bruck/Leitha Ost | 0,96 | 0,1715 | 0,0030 | 0,96 | 0,1715 | 0,0047 | 1,34 | 0,2401 | 0,006 | | | | | | | | | |

| | | | | | | | | | | | | | | | | | | | | |
|------|----------------------------------|----------------------------------|-------|--------|--------|-------|--------|--------|-------|--------|--------|-------|--------|--------|-------|--------|--------|-------|--------|--------|
| A05- | Großkrut | Poysdorf Nord | 1,53 | 0,2741 | 0,0048 | 1,53 | 0,2741 | 0,0075 | 2,14 | 0,3838 | 0,0110 | 2,15 | 0,3838 | 0,0173 | 3,07 | 0,4386 | 0,0139 | 3,08 | 0,4386 | 0,0219 |
| A06- | KN Bruckneudorf | Potzneusiedl | 1,94 | 0,3472 | 0,0061 | 1,94 | 0,3472 | 0,0095 | 2,71 | 0,4861 | 0,0140 | 2,72 | 0,4861 | 0,0220 | 3,89 | 0,5556 | 0,0176 | 3,90 | 0,5556 | 0,0277 |
| A06- | Potzneusiedl | Gattendorf | 0,84 | 0,1507 | 0,0026 | 0,84 | 0,1507 | 0,0041 | 1,18 | 0,2110 | 0,0061 | 1,18 | 0,2110 | 0,0095 | 1,69 | 0,2412 | 0,0076 | 1,69 | 0,2412 | 0,0120 |
| A06- | Gattendorf | Kittsee | 1,40 | 0,2521 | 0,0044 | 1,41 | 0,2521 | 0,0069 | 1,97 | 0,3529 | 0,0101 | 1,98 | 0,3529 | 0,0159 | 2,83 | 0,4033 | 0,0128 | 2,83 | 0,4033 | 0,0201 |
| A06- | Kittsee | Staatsgrenze Kittsee | 0,71 | 0,1280 | 0,0022 | 0,71 | 0,1280 | 0,0035 | 1,00 | 0,1793 | 0,0052 | 1,00 | 0,1793 | 0,0081 | 1,44 | 0,2049 | 0,0065 | 1,44 | 0,2049 | 0,0102 |
| A07- | KN Linz | Linz Franzosenhausweg | 0,50 | 0,0903 | 0,0016 | 0,50 | 0,0903 | 0,0025 | 0,71 | 0,1264 | 0,0036 | 0,71 | 0,1264 | 0,0057 | 1,01 | 0,1445 | 0,0046 | 1,02 | 0,1445 | 0,0072 |
| A07- | Linz Franzosenhausweg | Linz Salzburger Straße Neue Welt | 0,44 | 0,0788 | 0,0014 | 0,44 | 0,0788 | 0,0022 | 0,62 | 0,1104 | 0,0032 | 0,62 | 0,1104 | 0,0050 | 0,88 | 0,1261 | 0,0040 | 0,89 | 0,1261 | 0,0063 |
| A07- | Linz Salzburger Straße Neue Welt | Muldenstraße Bindermichl | 0,30 | 0,0547 | 0,0010 | 0,31 | 0,0547 | 0,0015 | 0,43 | 0,0766 | 0,0022 | 0,43 | 0,0766 | 0,0035 | 0,61 | 0,0876 | 0,0028 | 0,62 | 0,0876 | 0,0044 |
| A07- | Muldenstraße Bindermichl | Leonding Linz Zentrum | 0,15 | 0,0266 | 0,0005 | 0,15 | 0,0266 | 0,0007 | 0,21 | 0,0372 | 0,0011 | 0,21 | 0,0372 | 0,0017 | 0,30 | 0,0425 | 0,0013 | 0,30 | 0,0425 | 0,0021 |
| A07- | Leonding Linz Zentrum | Linz Wiener Straße | 0,21 | 0,0374 | 0,0007 | 0,21 | 0,0374 | 0,0010 | 0,29 | 0,0523 | 0,0015 | 0,29 | 0,0523 | 0,0024 | 0,42 | 0,0598 | 0,0019 | 0,42 | 0,0598 | 0,0030 |
| A07- | Linz Wiener Straße | Linz VOEST | 0,19 | 0,0347 | 0,0006 | 0,19 | 0,0347 | 0,0010 | 0,27 | 0,0486 | 0,0014 | 0,27 | 0,0486 | 0,0022 | 0,39 | 0,0556 | 0,0018 | 0,39 | 0,0556 | 0,0028 |
| A07- | Linz VOEST | Linz Industriezeile | 0,15 | 0,0272 | 0,0005 | 0,15 | 0,0272 | 0,0007 | 0,21 | 0,0381 | 0,0011 | 0,21 | 0,0381 | 0,0017 | 0,31 | 0,0436 | 0,0014 | 0,31 | 0,0436 | 0,0022 |
| A07- | Linz Industriezeile | Linz Prinz Eugenstraße | 0,24 | 0,0432 | 0,0008 | 0,24 | 0,0432 | 0,0012 | 0,34 | 0,0605 | 0,0017 | 0,34 | 0,0605 | 0,0027 | 0,49 | 0,0692 | 0,0022 | 0,49 | 0,0692 | 0,0034 |
| A07- | Linz Prinz Eugenstraße | Linz Hafenstraße | 0,45 | 0,0809 | 0,0014 | 0,45 | 0,0809 | 0,0022 | 0,63 | 0,1133 | 0,0033 | 0,63 | 0,1133 | 0,0051 | 0,91 | 0,1295 | 0,0041 | 0,91 | 0,1295 | 0,0065 |
| A07- | Linz Hafenstraße | Linz Urfa hr | 0,18 | 0,0318 | 0,0006 | 0,18 | 0,0318 | 0,0009 | 0,25 | 0,0445 | 0,0013 | 0,25 | 0,0445 | 0,0020 | 0,36 | 0,0509 | 0,0016 | 0,36 | 0,0509 | 0,0025 |
| A07- | Linz Urfa hr | Linz Dornach | 0,43 | 0,0770 | 0,0013 | 0,43 | 0,0770 | 0,0021 | 0,60 | 0,1078 | 0,0031 | 0,60 | 0,1078 | 0,0049 | 0,86 | 0,1232 | 0,0039 | 0,87 | 0,1232 | 0,0061 |
| A07- | Linz Dornach | Treffling | 0,94 | 0,1694 | 0,0030 | 0,95 | 0,1694 | 0,0047 | 1,32 | 0,2371 | 0,0068 | 1,33 | 0,2371 | 0,0107 | 1,90 | 0,2710 | 0,0086 | 1,90 | 0,2710 | 0,0135 |
| A07- | Treffling | Gallneukirchen | 0,71 | 0,1276 | 0,0022 | 0,71 | 0,1276 | 0,0035 | 1,00 | 0,1786 | 0,0051 | 1,00 | 0,1786 | 0,0081 | 1,43 | 0,2042 | 0,0065 | 1,44 | 0,2042 | 0,0102 |
| A07- | Gallneukirchen | Engerwitzdorf | 0,63 | 0,1137 | 0,0020 | 0,63 | 0,1137 | 0,0031 | 0,89 | 0,1592 | 0,0046 | 0,89 | 0,1592 | 0,0072 | 1,28 | 0,1819 | 0,0058 | 1,28 | 0,1819 | 0,0091 |
| A07- | Engerwitzdorf | Unterweikersdorf | 0,81 | 0,1458 | 0,0026 | 0,81 | 0,1458 | 0,0040 | 1,14 | 0,2041 | 0,0059 | 1,14 | 0,2041 | 0,0092 | 1,63 | 0,2332 | 0,0074 | 1,64 | 0,2332 | 0,0116 |
| A08- | KN Voralpenkreuz | Wels West | 2,49 | 0,4471 | 0,0078 | 2,50 | 0,4471 | 0,0123 | 3,50 | 0,6260 | 0,0180 | 3,51 | 0,6260 | 0,0283 | 5,02 | 0,7154 | 0,0227 | 5,03 | 0,7154 | 0,0357 |
| A08- | Wels West | KN Wels | 0,88 | 0,1577 | 0,0028 | 0,88 | 0,1577 | 0,0043 | 1,23 | 0,2208 | 0,0063 | 1,24 | 0,2208 | 0,0100 | 1,77 | 0,2523 | 0,0080 | 1,77 | 0,2523 | 0,0126 |
| A08- | KN Wels | Pichl/Bad Schallerbach | 0,97 | 0,1735 | 0,0030 | 0,97 | 0,1735 | 0,0048 | 1,36 | 0,2429 | 0,0070 | 1,36 | 0,2429 | 0,0110 | 1,95 | 0,2776 | 0,0088 | 1,95 | 0,2776 | 0,0138 |
| A08- | Pichl/Bad Schallerbach | Meggenhofen Gallspace | 2,44 | 0,4384 | 0,0077 | 2,45 | 0,4384 | 0,0121 | 3,43 | 0,6138 | 0,0176 | 3,44 | 0,6138 | 0,0277 | 4,92 | 0,7015 | 0,0223 | 4,93 | 0,7015 | 0,0350 |
| A08- | Meggenhofen Gallspace | Haag am Hausruck | 2,66 | 0,4778 | 0,0084 | 2,67 | 0,4778 | 0,0131 | 3,74 | 0,6690 | 0,0192 | 3,75 | 0,6690 | 0,0302 | 5,36 | 0,7645 | 0,0243 | 5,37 | 0,7645 | 0,0381 |
| A08- | Haag am Hausruck | Ried im Innkreis | 2,43 | 0,4361 | 0,0076 | 2,43 | 0,4361 | 0,0120 | 3,41 | 0,6105 | 0,0176 | 3,42 | 0,6105 | 0,0276 | 4,89 | 0,6977 | 0,0221 | 4,90 | 0,6977 | 0,0348 |
| A08- | Ried im Innkreis | Ort im Innkreis | 2,61 | 0,4680 | 0,0082 | 2,61 | 0,4680 | 0,0129 | 3,66 | 0,6553 | 0,0188 | 3,67 | 0,6553 | 0,0296 | 5,25 | 0,7489 | 0,0238 | 5,26 | 0,7489 | 0,0373 |
| A08- | Ort im Innkreis | Schärding Suben | 1,97 | 0,3533 | 0,0062 | 1,97 | 0,3533 | 0,0097 | 2,76 | 0,4946 | 0,0142 | 2,77 | 0,4946 | 0,0223 | 3,96 | 0,5652 | 0,0179 | 3,97 | 0,5652 | 0,0282 |
| A08- | Schärding Suben | Staatsgrenze Suben | 0,50 | 0,0893 | 0,0016 | 0,50 | 0,0893 | 0,0025 | 0,70 | 0,1250 | 0,0036 | 0,70 | 0,1250 | 0,0056 | 1,00 | 0,1428 | 0,0045 | 1,00 | 0,1428 | 0,0071 |
| A09- | KN Voralpenkreuz | Ried im Traunkreis | 1,23 | 0,2200 | 0,0039 | 1,23 | 0,2200 | 0,0061 | 1,72 | 0,3081 | 0,0089 | 1,73 | 0,3081 | 0,0139 | 2,47 | 0,3521 | 0,0112 | 2,47 | 0,3521 | 0,0175 |
| A09- | Ried im Traunkreis | Inzersdorf Kirchdorf | 2,30 | 0,4128 | 0,0072 | 2,30 | 0,4128 | 0,0114 | 3,23 | 0,5779 | 0,0166 | 3,24 | 0,5779 | 0,0261 | 4,63 | 0,6604 | 0,0209 | 4,64 | 0,6604 | 0,0329 |
| A09- | Inzersdorf Kirchdorf | Klaus | 2,80 | 0,5028 | 0,0088 | 2,81 | 0,5028 | 0,0138 | 3,93 | 0,7039 | 0,0202 | 3,94 | 0,7039 | 0,0318 | 5,64 | 0,8045 | 0,0255 | 5,65 | 0,8045 | 0,0401 |
| A09- | Klaus | St. Pankratz | 1,78 | 0,3196 | 0,0056 | 1,78 | 0,3196 | 0,0088 | 2,50 | 0,4474 | 0,0129 | 2,51 | 0,4474 | 0,0202 | 3,58 | 0,5114 | 0,0162 | 3,59 | 0,5114 | 0,0255 |
| A09- | St. Pankratz | Roßleiten Windischgarsten | 2,48 | 0,4459 | 0,0078 | 2,49 | 0,4459 | 0,0123 | 3,49 | 0,6243 | 0,0179 | 3,50 | 0,6243 | 0,0282 | 5,00 | 0,7135 | 0,0226 | 5,01 | 0,7135 | 0,0356 |
| A09- | Roßleiten Windischgarsten | Gleinkerau | 1,17 | 0,2096 | 0,0037 | 1,17 | 0,2096 | 0,0058 | 1,64 | 0,2934 | 0,0084 | 1,64 | 0,2934 | 0,0133 | 2,35 | 0,3354 | 0,0106 | 2,36 | 0,3354 | 0,0167 |
| A09- | Gleinkerau | Spital am Pyhrn | 0,88 | 0,1580 | 0,0028 | 0,88 | 0,1580 | 0,0043 | 1,24 | 0,2212 | 0,0064 | 1,24 | 0,2212 | 0,0100 | 1,77 | 0,2528 | 0,0080 | 1,78 | 0,2528 | 0,0126 |
| A09- | Spital am Pyhrn | Ardning / Admont | 4,53 | 0,4022 | 0,0070 | 4,54 | 0,4022 | 0,0111 | 6,35 | 0,5631 | 0,0162 | 6,36 | 0,5631 | 0,0254 | 9,33 | 0,6436 | 0,0204 | 9,34 | 0,6436 | 0,0321 |
| A09- | Ardning / Admont | Liezen | 0,51 | 0,0917 | 0,0016 | 0,51 | 0,0917 | 0,0025 | 0,72 | 0,1284 | 0,0037 | 0,72 | 0,1284 | 0,0058 | 1,03 | 0,1467 | 0,0047 | 1,03 | 0,1467 | 0,0073 |
| A09- | Liezen | Rottenmann | 1,07 | 0,1916 | 0,0034 | 1,07 | 0,1916 | 0,0053 | 1,50 | 0,2682 | 0,0077 | 1,50 | 0,2682 | 0,0121 | 2,15 | 0,3065 | 0,0097 | 2,15 | 0,3065 | 0,0153 |
| A09- | Rottenmann | Trieben | 2,66 | 0,4776 | 0,0084 | 2,67 | 0,4776 | 0,0131 | 3,73 | 0,6686 | 0,0192 | 3,74 | 0,6686 | 0,0302 | 5,36 | 0,7641 | 0,0242 | 5,37 | 0,7641 | 0,0381 |
| A09- | Trieben | Treglwang | 2,16 | 0,3883 | 0,0068 | 2,17 | 0,3883 | 0,0107 | 3,04 | 0,5436 | 0,0156 | 3,04 | 0,5436 | 0,0246 | 4,36 | 0,6212 | 0,0197 | 4,37 | 0,6212 | 0,0310 |
| A09- | Treglwang | Kalwang | 2,91 | 0,5218 | 0,0091 | 2,91 | 0,5218 | 0,0143 | 4,08 | 0,7305 | 0,0210 | 4,09 | 0,7305 | 0,0330 | 5,85 | 0,8349 | 0,0265 | 5,87 | 0,8349 | 0,0416 |
| A09- | Kalwang | Mautern | 1,35 | 0,2430 | 0,0043 | 1,36 | 0,2430 | 0,0067 | 1,90 | 0,3401 | 0,0098 | 1,90 | 0,3401 | 0,0154 | 2,73 | 0,3887 | 0,0123 | 2,73 | 0,3887 | 0,0194 |
| A09- | Mautern | Kammern | 1,52 | 0,2733 | 0,0048 | 1,53 | 0,2733 | 0,0075 | 2,14 | 0,3826 | 0,0110 | 2,14 | 0,3826 | 0,0173 | 3,07 | 0,4373 | 0,0139 | 3,07 | 0,4373 | 0,0218 |
| A09- | Kammern | Traboch | 1,59 | 0,2858 | 0,0050 | 1,60 | 0,2858 | 0,0079 | 2,23 | 0,4001 | 0,0115 | 2,24 | 0,4001 | 0,0181 | 3,21 | 0,4572 | 0,0145 | 3,21 | 0,4572 | 0,0228 |
| A09- | Traboch | Terminal St. Michael | 0,31 | 0,0561 | 0,0010 | 0,31 | 0,0561 | 0,0015 | 0,44 | 0,0786 | 0,0023 | 0,44 | 0,0786 | 0,0035 | 0,63 | 0,0898 | 0,0028 | 0,63 | 0,0898 | 0,0045 |
| A09- | Terminal St. Michael | KN St. Michael | 0,59 | 0,1052 | 0,0018 | 0,59 | 0,1052 | 0,0029 | 0,82 | 0,1473 | 0,0042 | 0,82 | 0,1473 | 0,0067 | 1,18 | 0,1683 | 0,0053 | 1,18 | 0,1683 | 0,0084 |
| A09- | KN St. Michael | Übelbach | 11,04 | 0,9797 | 0,0171 | 11,05 | 0,9797 | 0,0289 | 15,48 | 1,3716 | 0,0394 | 15,50 | 1,3716 | 0,0620 | 22,72 | 1,5676 | 0,0497 | 22,74 | 1,5676 | 0,0781 |
| A09- | Übelbach | KN Peggau Deutschfeistritz | 1,81 | 0,3240 | 0,0057 | 1,81 | 0,3240 | 0,0089 | 2,53 | 0,4537 | 0,0130 | 2,54 | 0,4537 | 0,0205 | 3,63 | 0,5185 | 0,0164 | 3,64 | 0,5185 | 0,0258 |
| A09- | KN Peggau Deutschfeistritz | Gratkorn Nord | 0,86 | 0,1535 | 0,0027 | 0,86 | 0,1535 | 0,0042 | 1,20 | 0,2149 | 0,0062 | 1,20 | 0,2149 | 0,0097 | 1,72 | 0,2456 | 0,0078 | 1,73 | 0,2456 | 0,0122 |
| A09- | Gratkorn Nord | Gratkorn Süd | 0,94 | 0,1686 | 0,0030 | 0,94 | 0,1686 | 0,0046 | 1,32 | 0,2360 | 0,0068 | 1,32 | 0,2360 | 0,0107 | 1,89 | 0,2698 | 0,0086 | 1,90 | 0,2698 | |

| | | | | | | | | | | | | | | | | | | | | |
|------|-------------------------------------|-------------------------------------|-------|--------|--------|-------|--------|--------|-------|--------|--------|-------|--------|--------|-------|--------|--------|-------|--------|--------|
| A10- | Hallein | Kuchl | 1,30 | 0,2342 | 0,0041 | 1,31 | 0,2342 | 0,0064 | 1,83 | 0,3278 | 0,0094 | 1,84 | 0,3278 | 0,0148 | 2,63 | 0,3747 | 0,0119 | 2,63 | 0,3747 | 0,0187 |
| A10- | Kuchl | Golling / Abtenau | 1,31 | 0,2354 | 0,0041 | 1,31 | 0,2354 | 0,0065 | 1,84 | 0,3296 | 0,0095 | 1,85 | 0,3296 | 0,0149 | 2,64 | 0,3766 | 0,0119 | 2,65 | 0,3766 | 0,0188 |
| A10- | Golling / Abtenau | Paß Lueg | 1,37 | 0,2456 | 0,0043 | 1,37 | 0,2456 | 0,0068 | 1,92 | 0,3439 | 0,0099 | 1,93 | 0,3439 | 0,0155 | 2,76 | 0,3930 | 0,0125 | 2,76 | 0,3930 | 0,0196 |
| A10- | Paß Lueg | Werfen | 1,95 | 0,3499 | 0,0061 | 1,95 | 0,3499 | 0,0096 | 2,94 | 0,4898 | 0,0141 | 2,74 | 0,4898 | 0,0221 | 3,92 | 0,5598 | 0,0178 | 3,93 | 0,5598 | 0,0279 |
| A10- | Werfen | Pfarrwerfen / Werfen | 0,25 | 0,0456 | 0,0008 | 0,25 | 0,0456 | 0,0013 | 0,36 | 0,0638 | 0,0018 | 0,36 | 0,0638 | 0,0029 | 0,51 | 0,0730 | 0,0023 | 0,51 | 0,0730 | 0,0036 |
| A10- | Pfarrwerfen / Werfen | KN Pongau | 0,55 | 0,0990 | 0,0017 | 0,55 | 0,0990 | 0,0027 | 0,77 | 0,1385 | 0,0040 | 0,78 | 0,1385 | 0,0063 | 1,11 | 0,1583 | 0,0050 | 1,11 | 0,1583 | 0,0079 |
| A101 | KN Pongau | Bischofshofen Mühlbach a. Hochkönig | 0,82 | 0,1472 | 0,0026 | 0,82 | 0,1472 | 0,0040 | 1,15 | 0,2061 | 0,0059 | 1,15 | 0,2061 | 0,0093 | 1,65 | 0,2355 | 0,0075 | 1,66 | 0,2355 | 0,0117 |
| A10- | KN Pongau | Lammertal Hütttau | 2,24 | 0,4025 | 0,0070 | 2,25 | 0,4025 | 0,0111 | 3,15 | 0,5635 | 0,0162 | 3,16 | 0,5635 | 0,0255 | 4,51 | 0,6440 | 0,0204 | 4,53 | 0,6440 | 0,0321 |
| A10- | Lammertal Hütttau | F. Verbindung GH Eben | 0,58 | 0,1036 | 0,0018 | 0,58 | 0,1036 | 0,0028 | 0,81 | 0,1450 | 0,0042 | 0,81 | 0,1450 | 0,0066 | 1,16 | 0,1658 | 0,0053 | 1,17 | 0,1658 | 0,0083 |
| A10- | F. Verbindung GH Eben | Eben | 0,27 | 0,0480 | 0,0008 | 0,27 | 0,0480 | 0,0013 | 0,38 | 0,0672 | 0,0019 | 0,38 | 0,0672 | 0,0030 | 0,54 | 0,0768 | 0,0024 | 0,54 | 0,0768 | 0,0038 |
| A10- | Eben | Radstadt Altenmarkt Graz | 0,59 | 0,1066 | 0,0019 | 0,60 | 0,1066 | 0,0029 | 0,83 | 0,1492 | 0,0043 | 0,84 | 0,1492 | 0,0067 | 1,20 | 0,1706 | 0,0054 | 1,20 | 0,1706 | 0,0085 |
| A10- | Radstadt Altenmarkt Graz | Flachau | 0,83 | 0,1491 | 0,0026 | 0,83 | 0,1491 | 0,0041 | 1,17 | 0,2087 | 0,0060 | 1,17 | 0,2087 | 0,0094 | 1,67 | 0,2385 | 0,0076 | 1,68 | 0,2385 | 0,0119 |
| A10- | Flachau | Flachauwinkel | 3,05 | 0,2908 | 0,0051 | 3,05 | 0,2908 | 0,0080 | 4,27 | 0,4071 | 0,0117 | 4,28 | 0,4071 | 0,0184 | 6,26 | 0,4653 | 0,0148 | 6,27 | 0,4653 | 0,0232 |
| A10- | Flachauwinkel | Zederhaus | 7,69 | 0,7328 | 0,0128 | 7,69 | 0,7328 | 0,0202 | 10,77 | 1,0260 | 0,0295 | 10,79 | 1,0260 | 0,0464 | 15,78 | 1,1725 | 0,0372 | 15,80 | 1,1725 | 0,0584 |
| A10- | Zederhaus | St. Michael/Lungau | 5,07 | 0,4835 | 0,0085 | 5,08 | 0,4835 | 0,0133 | 7,11 | 0,6769 | 0,0195 | 7,12 | 0,6769 | 0,0306 | 10,41 | 0,7736 | 0,0245 | 10,43 | 0,7736 | 0,0386 |
| A10- | St. Michael/Lungau | Rennweg Katschberg | 3,72 | 0,3545 | 0,0062 | 3,72 | 0,3545 | 0,0097 | 5,21 | 0,4963 | 0,0143 | 5,22 | 0,4963 | 0,0224 | 7,63 | 0,5672 | 0,0180 | 7,65 | 0,5672 | 0,0283 |
| A102 | Seeboden | KN Spittal Millstätter See | 0,43 | 0,0776 | 0,0014 | 0,43 | 0,0776 | 0,0021 | 0,61 | 0,1086 | 0,0031 | 0,61 | 0,1086 | 0,0049 | 0,87 | 0,1242 | 0,0039 | 0,87 | 0,1242 | 0,0062 |
| A102 | KN Spittal Millstätter See | Lendorf | 0,93 | 0,1674 | 0,0029 | 0,93 | 0,1674 | 0,0046 | 1,31 | 0,2344 | 0,0067 | 1,31 | 0,2344 | 0,0106 | 1,88 | 0,2678 | 0,0085 | 1,88 | 0,2678 | 0,0134 |
| A10- | Rennweg Katschberg | Gmünd Maltatal | 3,77 | 0,6774 | 0,0119 | 3,78 | 0,6774 | 0,0186 | 5,30 | 0,9483 | 0,0273 | 5,31 | 0,9483 | 0,0428 | 7,60 | 1,0838 | 0,0344 | 7,62 | 1,0838 | 0,0540 |
| A10- | Gmünd Maltatal | KN Spittal Millstätter See | 2,15 | 0,3855 | 0,0067 | 2,15 | 0,3855 | 0,0106 | 3,01 | 0,5397 | 0,0155 | 3,02 | 0,5397 | 0,0244 | 4,32 | 0,6168 | 0,0196 | 4,34 | 0,6168 | 0,0307 |
| A10- | KN Spittal Millstätter See | Spittal Ost | 1,63 | 0,2920 | 0,0051 | 1,63 | 0,2920 | 0,0080 | 2,28 | 0,4088 | 0,0118 | 2,29 | 0,4088 | 0,0185 | 3,28 | 0,4672 | 0,0148 | 3,28 | 0,4672 | 0,0233 |
| A10- | Spittal Ost | Paternion Feistritz | 2,81 | 0,5043 | 0,0088 | 2,82 | 0,5043 | 0,0139 | 3,94 | 0,7060 | 0,0203 | 3,95 | 0,7060 | 0,0319 | 5,66 | 0,8068 | 0,0256 | 5,67 | 0,8068 | 0,0402 |
| A10- | Paternion Feistritz | Villach West | 3,03 | 0,5435 | 0,0095 | 3,03 | 0,5435 | 0,0149 | 4,25 | 0,7609 | 0,0219 | 4,26 | 0,7609 | 0,0344 | 6,10 | 0,8696 | 0,0276 | 6,11 | 0,8696 | 0,0433 |
| A10- | Villach West | Villach Ossiacher See | 1,31 | 0,2350 | 0,0041 | 1,31 | 0,2350 | 0,0065 | 1,84 | 0,3289 | 0,0095 | 1,84 | 0,3289 | 0,0149 | 2,64 | 0,3759 | 0,0119 | 2,64 | 0,3759 | 0,0187 |
| A10- | Villach Ossiacher See | KN Villach | 1,02 | 0,1836 | 0,0032 | 1,02 | 0,1836 | 0,0050 | 1,44 | 0,2570 | 0,0074 | 1,44 | 0,2570 | 0,0116 | 2,06 | 0,2938 | 0,0093 | 2,06 | 0,2938 | 0,0146 |
| A11- | KN Villach | St. Niklas Faakersee | 0,73 | 0,1314 | 0,0023 | 0,73 | 0,1314 | 0,0036 | 1,03 | 0,1840 | 0,0053 | 1,03 | 0,1840 | 0,0083 | 1,47 | 0,2102 | 0,0067 | 1,48 | 0,2102 | 0,0105 |
| A11- | St. Niklas Faakersee | St. Jakob/Rosental | 1,84 | 0,3300 | 0,0058 | 1,84 | 0,3300 | 0,0091 | 2,58 | 0,4621 | 0,0133 | 2,59 | 0,4621 | 0,0209 | 3,70 | 0,5281 | 0,0167 | 3,71 | 0,5281 | 0,0263 |
| A11- | St. Jakob/Rosental | Staatsgrenze Karawankentunnel | 16,10 | 0,3883 | 0,0068 | 16,11 | 0,3883 | 0,0107 | 22,55 | 0,5436 | 0,0156 | 22,56 | 0,5436 | 0,0246 | 33,63 | 0,6212 | 0,0197 | 33,64 | 0,6212 | 0,0310 |
| A12- | Staatsgrenze Kufstein | Kufstein Nord | 0,36 | 0,0000 | 0,0000 | 0,36 | 0,0000 | 0,0000 | 0,51 | 0,0000 | 0,0000 | 0,51 | 0,0000 | 0,0000 | 0,76 | 0,0000 | 0,0000 | 0,76 | 0,0000 | 0,0000 |
| A12- | Kufstein Nord | Kufstein Süd | 0,93 | 0,0000 | 0,0000 | 0,93 | 0,0000 | 0,0000 | 1,31 | 0,0000 | 0,0000 | 1,31 | 0,0000 | 0,0000 | 1,96 | 0,0000 | 0,0000 | 1,96 | 0,0000 | 0,0000 |
| A12- | Kufstein Süd | Kirchbichl Langkampfen | 1,27 | 0,0000 | 0,0000 | 1,27 | 0,0000 | 0,0000 | 1,78 | 0,0000 | 0,0000 | 1,78 | 0,0000 | 0,0000 | 2,68 | 0,0000 | 0,0000 | 2,68 | 0,0000 | 0,0000 |
| A12- | Kirchbichl Langkampfen | Wörgl Ost St.Johann i. T. Brixental | 1,25 | 0,0000 | 0,0000 | 1,25 | 0,0000 | 0,0000 | 1,75 | 0,0000 | 0,0000 | 1,75 | 0,0000 | 0,0000 | 2,62 | 0,0000 | 0,0000 | 2,62 | 0,0000 | 0,0000 |
| A12- | Wörgl Ost St.Johann i. T. Brixental | Wörgl West | 0,66 | 0,0000 | 0,0000 | 0,66 | 0,0000 | 0,0000 | 0,92 | 0,0000 | 0,0000 | 0,92 | 0,0000 | 0,0000 | 1,38 | 0,0000 | 0,0000 | 1,38 | 0,0000 | 0,0000 |
| A12- | Wörgl West | Kramsach Rattenberg Brixlegg | 2,80 | 0,0000 | 0,0000 | 2,80 | 0,0000 | 0,0000 | 3,92 | 0,0000 | 0,0000 | 3,92 | 0,0000 | 0,0000 | 5,88 | 0,0000 | 0,0000 | 5,88 | 0,0000 | 0,0000 |
| A12- | Kramsach Rattenberg Brixlegg | Wiesing Achensee Zillertal | 1,72 | 0,0000 | 0,0000 | 1,72 | 0,0000 | 0,0000 | 2,40 | 0,0000 | 0,0000 | 2,40 | 0,0000 | 0,0000 | 3,61 | 0,0000 | 0,0000 | 3,61 | 0,0000 | 0,0000 |
| A12- | Wiesing Achensee Zillertal | Jenbach | 0,68 | 0,0000 | 0,0000 | 0,68 | 0,0000 | 0,0000 | 0,95 | 0,0000 | 0,0000 | 0,95 | 0,0000 | 0,0000 | 1,43 | 0,0000 | 0,0000 | 1,43 | 0,0000 | 0,0000 |
| A12- | Jenbach | Schwaz | 1,50 | 0,0000 | 0,0000 | 1,50 | 0,0000 | 0,0000 | 2,10 | 0,0000 | 0,0000 | 2,10 | 0,0000 | 0,0000 | 3,15 | 0,0000 | 0,0000 | 3,15 | 0,0000 | 0,0000 |
| A12- | Schwaz | Vomp | 0,86 | 0,0000 | 0,0000 | 0,86 | 0,0000 | 0,0000 | 1,20 | 0,0000 | 0,0000 | 1,20 | 0,0000 | 0,0000 | 1,80 | 0,0000 | 0,0000 | 1,80 | 0,0000 | 0,0000 |
| A12- | Vomp | Wattens | 1,77 | 0,0000 | 0,0000 | 1,77 | 0,0000 | 0,0000 | 2,47 | 0,0000 | 0,0000 | 2,47 | 0,0000 | 0,0000 | 3,71 | 0,0000 | 0,0000 | 3,71 | 0,0000 | 0,0000 |
| A12- | Wattens | Hall/Tirol Mitte | 1,57 | 0,0000 | 0,0000 | 1,57 | 0,0000 | 0,0000 | 2,19 | 0,0000 | 0,0000 | 2,19 | 0,0000 | 0,0000 | 3,29 | 0,0000 | 0,0000 | 3,29 | 0,0000 | 0,0000 |
| A12- | Hall/Tirol Mitte | Hall/Tirol West | 0,63 | 0,0000 | 0,0000 | 0,63 | 0,0000 | 0,0000 | 0,88 | 0,0000 | 0,0000 | 0,88 | 0,0000 | 0,0000 | 1,32 | 0,0000 | 0,0000 | 1,32 | 0,0000 | 0,0000 |
| A12- | Hall/Tirol West | A12 Innsbruck Ost | 0,70 | 0,0000 | 0,0000 | 0,70 | 0,0000 | 0,0000 | 0,97 | 0,0000 | 0,0000 | 0,97 | 0,0000 | 0,0000 | 1,46 | 0,0000 | 0,0000 | 1,46 | 0,0000 | 0,0000 |
| A12- | A12 Innsbruck Ost | Innsbruck Mitte | 0,48 | 0,0226 | 0,0004 | 0,48 | 0,0226 | 0,0006 | 0,67 | 0,0317 | 0,0009 | 0,67 | 0,0317 | 0,0014 | 0,99 | 0,0362 | 0,0011 | 0,99 | 0,0362 | 0,0018 |
| A12- | Innsbruck Mitte | A12 Innsbruck West | 0,71 | 0,1280 | 0,0022 | 0,71 | 0,1280 | 0,0035 | 1,00 | 0,1792 | 0,0052 | 1,00 | 0,1792 | 0,0081 | 1,44 | 0,2048 | 0,0065 | 1,44 | 0,2048 | 0,0102 |
| A12- | A12 Innsbruck West | Innsbruck Kranebitten | 0,93 | 0,1678 | 0,0029 | 0,94 | 0,1678 | 0,0046 | 1,31 | 0,2349 | 0,0068 | 1,32 | 0,2349 | 0,0106 | 1,88 | 0,2684 | 0,0085 | 1,89 | 0,2684 | 0,0134 |
| A12- | Innsbruck Kranebitten | Zirl Ost Garmisch Seefeld | 1,08 | 0,1947 | 0,0034 | 1,09 | 0,1947 | 0,0054 | 1,52 | 0,2726 | 0,0078 | 1,53 | 0,2726 | 0,0123 | 2,18 | 0,3115 | 0,0099 | 2,19 | 0,3115 | 0,0155 |
| A12- | Zirl Ost Garmisch Seefeld | Zirl West | 0,68 | 0,1218 | 0,0021 | 0,68 | 0,1218 | 0,0033 | 0,95 | 0,1705 | 0,0049 | 0,95 | 0,1705 | 0,0077 | 1,37 | 0,1949 | 0,0062 | 1,37 | 0,1949 | 0,0097 |
| A12- | Zirl West | Petttau | 1,22 | 0,2181 | 0,0038 | 1,22 | 0,2181 | 0,0060 | 1,71 | 0,3054 | 0,0088 | 1,71 | 0,3054 | 0,0138 | 2,45 | 0,3490 | 0,0111 | 2,45 | 0,3490 | 0,0174 |
| A12- | Petttau | Telfs Ost | 1,23 | 0,2205 | 0,0039 | 1,23 | 0,2205 | 0,0061 | 1,72 | 0,3087 | 0,0089 | 1,73 | 0,3087 | 0,0139 | 2,47 | 0,3528 | 0,0112 | 2,48 | 0,3528 | 0,0176 |
| A12- | Telfs Ost | Telfs West | 0,60 | 0,1077 | 0,0019 | 0,60 | 0,1077 | 0,0030 | 0,84 | 0,1508 | 0,0043 | 0,84 | 0,1508 | 0,0068 | 1,21 | 0,1723 | 0,0055 | 1,21 | 0,1723 | 0,0086 |
| A12- | Telfs West | Mötz Reutte | 1,94 | 0,3480 | 0,0061 | 1,94 | 0,3480 | 0,0096 | 2,72 | 0,4872 | 0,0140 | 2,73 | 0,4872 | 0,0220 | 3,90 | 0,5568 | 0,0177 | 3,91 | 0,5568 | 0,0278 |
| A12- | Mötz Reutte | Haiming Ötztal | 2,26 | 0,4048 | 0,0071 | 2,26 | 0,4048 | 0,0111 | 3,16 | 0,5667 | 0,0163 | 3,17 | 0,5667 | 0,0256 | 4,54 | 0,6477 | 0,0205 | 4,55 | 0,6477 | 0,0323 |
| A12- | Haiming Ötztal | Imst | 1,80 | 0,3222 | 0,0056 | 1,80 | 0,3222 | 0,0089 | 2,52 | 0,4511 | 0,0130 | 2,53 | 0,4511 | 0,0204 | 3,61 | 0,5156 | 0,0164 | 3,62 | 0,5156 | 0,0257 |
| A12- | Imst | Imst Au | 0,30 | 0,0546 | 0,0010 | 0,30 | 0,0546 | 0,0015 | 0,43 | 0,0764 | 0,0022 | 0,43 | 0,0764 | 0,0035 | 0,61 | 0,0873 | 0,0028 | 0,61 | 0,0873 | 0,0044 |
| A12- | Imst Au | Mils | 0,65 | 0,1172 | 0,0021 | 0,65 | 0,1172 | 0,0032 | 0,92 | 0,1641 | 0,0047 | 0,92 | 0,1641 | 0,0074 | 1,31 | 0,1875 | 0,0059 | 1,32 | 0,1875 | 0,0093 |
| A12- | Mils | Mils Schönwies | 1,05 | 0,1888 | 0,0033 | 1,05 | 0,1888 | 0,0052 | 1,48 | 0,2643 | 0,0076 | 1,48 | 0,2643 | 0,0119 | 2,12 | 0,3021 | 0,0096 | 2,12 | 0,3021 | 0,0151 |
| A12- | Mils Schönwies | KN Oberinnt | | | | | | | | | | | | | | | | | | |

| | | | | | | | | | | | | | | | | | | | | |
|------|------------------------------------|------------------------------------|------|--------|--------|------|--------|--------|------|--------|--------|------|--------|--------|------|--------|--------|------|--------|--------|
| A14- | Staatsgrenze Hörbranz | Hörbranz Lochau | 0,28 | 0,0504 | 0,0009 | 0,28 | 0,0504 | 0,0014 | 0,39 | 0,0706 | 0,0020 | 0,40 | 0,0706 | 0,0032 | 0,57 | 0,0807 | 0,0026 | 0,57 | 0,0807 | 0,0040 |
| A14- | Hörbranz Lochau | KN Bregenz | 1,73 | 0,3100 | 0,0054 | 1,73 | 0,3100 | 0,0085 | 2,42 | 0,4339 | 0,0125 | 2,43 | 0,4339 | 0,0196 | 3,48 | 0,4959 | 0,0157 | 3,49 | 0,4959 | 0,0247 |
| A14- | KN Bregenz | Lauterach Wolfurt | 0,09 | 0,0156 | 0,0003 | 0,09 | 0,0156 | 0,0004 | 0,12 | 0,0218 | 0,0006 | 0,12 | 0,0218 | 0,0010 | 0,17 | 0,0249 | 0,0008 | 0,17 | 0,0249 | 0,0012 |
| A14- | Lauterach Wolfurt | Wolfurt Lauterach | 0,77 | 0,1379 | 0,0024 | 0,77 | 0,1379 | 0,0038 | 1,08 | 0,1931 | 0,0056 | 1,08 | 0,1931 | 0,0087 | 1,55 | 0,2207 | 0,0070 | 1,55 | 0,2207 | 0,0110 |
| A14- | Wolfurt Lauterach | Dornbirn Nord Bregenzerwald | 0,30 | 0,0534 | 0,0009 | 0,30 | 0,0534 | 0,0015 | 0,42 | 0,0747 | 0,0021 | 0,42 | 0,0747 | 0,0034 | 0,60 | 0,0854 | 0,0027 | 0,60 | 0,0854 | 0,0043 |
| A14- | Dornbirn Nord Bregenzerwald | Dornbirn Süd Lustenau | 0,83 | 0,1491 | 0,0026 | 0,83 | 0,1491 | 0,0041 | 1,17 | 0,2087 | 0,0060 | 1,17 | 0,2087 | 0,0094 | 1,67 | 0,2385 | 0,0076 | 1,68 | 0,2385 | 0,0119 |
| A14- | Dornbirn Süd Lustenau | Hohenems | 1,17 | 0,2098 | 0,0037 | 1,17 | 0,2098 | 0,0058 | 1,64 | 0,2937 | 0,0084 | 1,64 | 0,2937 | 0,0133 | 2,35 | 0,3356 | 0,0106 | 2,36 | 0,3356 | 0,0167 |
| A14- | Hohenems | Altach Götzis | 0,76 | 0,1368 | 0,0024 | 0,76 | 0,1368 | 0,0038 | 1,07 | 0,1915 | 0,0055 | 1,07 | 0,1915 | 0,0087 | 1,53 | 0,2188 | 0,0069 | 1,54 | 0,2188 | 0,0109 |
| A14- | Altach Götzis | Götzis | 0,58 | 0,1043 | 0,0018 | 0,58 | 0,1043 | 0,0029 | 0,82 | 0,1460 | 0,0042 | 0,82 | 0,1460 | 0,0066 | 1,17 | 0,1668 | 0,0053 | 1,17 | 0,1668 | 0,0083 |
| A14- | Götzis | Klaus Koblach | 0,50 | 0,0906 | 0,0016 | 0,51 | 0,0906 | 0,0025 | 0,71 | 0,1268 | 0,0036 | 0,71 | 0,1268 | 0,0057 | 1,02 | 0,1449 | 0,0046 | 1,02 | 0,1449 | 0,0072 |
| A14- | Klaus Koblach | Rankweil | 0,89 | 0,1592 | 0,0028 | 0,89 | 0,1592 | 0,0044 | 1,24 | 0,2228 | 0,0064 | 1,25 | 0,2228 | 0,0101 | 1,79 | 0,2547 | 0,0081 | 1,79 | 0,2547 | 0,0127 |
| A14- | Rankweil | Feldkirch Frastanz | 1,26 | 0,2267 | 0,0040 | 1,27 | 0,2267 | 0,0062 | 1,77 | 0,3174 | 0,0091 | 1,78 | 0,3174 | 0,0143 | 2,54 | 0,3628 | 0,0115 | 2,55 | 0,3628 | 0,0181 |
| A14- | Feldkirch Frastanz | Nenzing Bludesch | 2,00 | 0,3585 | 0,0063 | 2,00 | 0,3585 | 0,0099 | 2,80 | 0,5019 | 0,0144 | 2,81 | 0,5019 | 0,0227 | 4,02 | 0,5736 | 0,0182 | 4,03 | 0,5736 | 0,0286 |
| A14- | Nenzing Bludesch | Bludenz Nüziders | 1,48 | 0,2662 | 0,0047 | 1,49 | 0,2662 | 0,0073 | 2,08 | 0,3726 | 0,0107 | 2,09 | 0,3726 | 0,0168 | 2,99 | 0,4259 | 0,0135 | 2,99 | 0,4259 | 0,0212 |
| A14- | Bludenz Nüziders | Brandnertal | 0,21 | 0,0370 | 0,0006 | 0,21 | 0,0370 | 0,0010 | 0,29 | 0,0519 | 0,0015 | 0,29 | 0,0519 | 0,0023 | 0,42 | 0,0593 | 0,0019 | 0,42 | 0,0593 | 0,0030 |
| A14- | Brandnertal | Bludenz Bürs | 0,34 | 0,0618 | 0,0011 | 0,35 | 0,0618 | 0,0017 | 0,48 | 0,0865 | 0,0025 | 0,48 | 0,0865 | 0,0039 | 0,69 | 0,0989 | 0,0031 | 0,69 | 0,0989 | 0,0049 |
| A14- | Bludenz Bürs | Bludenz Montafon | 0,49 | 0,0876 | 0,0015 | 0,49 | 0,0876 | 0,0024 | 0,68 | 0,1226 | 0,0035 | 0,69 | 0,1226 | 0,0055 | 0,98 | 0,1402 | 0,0044 | 0,99 | 0,1402 | 0,0070 |
| A141 | KN Bregenz | Bregenz Citytunnel | 0,45 | 0,0802 | 0,0014 | 0,45 | 0,0802 | 0,0022 | 0,63 | 0,1123 | 0,0032 | 0,63 | 0,1123 | 0,0051 | 0,90 | 0,1284 | 0,0041 | 0,90 | 0,1284 | 0,0064 |
| A21- | KN Steinhäusl | Hochstraß | 0,74 | 0,1324 | 0,0023 | 0,74 | 0,1324 | 0,0036 | 1,03 | 0,1853 | 0,0053 | 1,04 | 0,1853 | 0,0084 | 1,48 | 0,2118 | 0,0067 | 1,49 | 0,2118 | 0,0106 |
| A21- | Hochstraß | Alland | 2,58 | 0,4624 | 0,0081 | 2,58 | 0,4624 | 0,0127 | 3,62 | 0,6474 | 0,0186 | 3,63 | 0,6474 | 0,0292 | 5,19 | 0,7399 | 0,0235 | 5,20 | 0,7399 | 0,0369 |
| A21- | Alland | Mayerling | 0,52 | 0,0939 | 0,0016 | 0,52 | 0,0939 | 0,0026 | 0,73 | 0,1314 | 0,0038 | 0,74 | 0,1314 | 0,0059 | 1,05 | 0,1502 | 0,0048 | 1,06 | 0,1502 | 0,0075 |
| A21- | Mayerling | Heiligenkreuz | 1,21 | 0,2175 | 0,0038 | 1,21 | 0,2175 | 0,0060 | 1,70 | 0,3045 | 0,0088 | 1,71 | 0,3045 | 0,0138 | 2,44 | 0,3480 | 0,0110 | 2,45 | 0,3480 | 0,0173 |
| A21- | Heiligenkreuz | Heiligenbrühl | 0,68 | 0,1212 | 0,0021 | 0,68 | 0,1212 | 0,0033 | 0,95 | 0,1697 | 0,0049 | 0,95 | 0,1697 | 0,0077 | 1,36 | 0,1940 | 0,0062 | 1,36 | 0,1940 | 0,0097 |
| A21- | Hinterbrühl | Gießhübl | 1,27 | 0,2274 | 0,0040 | 1,27 | 0,2274 | 0,0063 | 1,78 | 0,3184 | 0,0092 | 1,78 | 0,3184 | 0,0144 | 2,55 | 0,3638 | 0,0115 | 2,56 | 0,3638 | 0,0181 |
| A21- | Gießhübl | Brunn/Gebirge | 1,06 | 0,1903 | 0,0033 | 1,06 | 0,1903 | 0,0052 | 1,49 | 0,2664 | 0,0077 | 1,49 | 0,2664 | 0,0120 | 2,13 | 0,3044 | 0,0097 | 2,14 | 0,3044 | 0,0152 |
| A21- | Brunn/Gebirge | KN Vösendorf | 0,47 | 0,0846 | 0,0015 | 0,47 | 0,0846 | 0,0023 | 0,66 | 0,1185 | 0,0034 | 0,66 | 0,1185 | 0,0054 | 0,95 | 0,1354 | 0,0043 | 0,95 | 0,1354 | 0,0068 |
| A22- | KN Wien Kaisermühlen | Kaisermühlen | 0,37 | 0,0669 | 0,0012 | 0,37 | 0,0669 | 0,0018 | 0,52 | 0,0936 | 0,0027 | 0,52 | 0,0936 | 0,0042 | 0,75 | 0,1070 | 0,0034 | 0,75 | 0,1070 | 0,0053 |
| A22- | Kaisermühlen | Reichsbrücke | 0,31 | 0,0554 | 0,0010 | 0,31 | 0,0554 | 0,0015 | 0,43 | 0,0776 | 0,0022 | 0,43 | 0,0776 | 0,0035 | 0,62 | 0,0887 | 0,0028 | 0,62 | 0,0887 | 0,0044 |
| A22- | Reichsbrücke | Kagran Vienna International Center | 0,12 | 0,0214 | 0,0004 | 0,12 | 0,0214 | 0,0006 | 0,17 | 0,0299 | 0,0009 | 0,17 | 0,0299 | 0,0014 | 0,24 | 0,0342 | 0,0011 | 0,24 | 0,0342 | 0,0017 |
| A22- | Kagran Vienna International Center | Brigittenauebrücke | 0,19 | 0,0342 | 0,0006 | 0,19 | 0,0342 | 0,0009 | 0,27 | 0,0479 | 0,0014 | 0,27 | 0,0479 | 0,0022 | 0,38 | 0,0547 | 0,0017 | 0,38 | 0,0547 | 0,0027 |
| A22- | Brigittenauebrücke | Floridsdorferbrücke | 0,31 | 0,0552 | 0,0010 | 0,31 | 0,0552 | 0,0015 | 0,43 | 0,0773 | 0,0022 | 0,43 | 0,0773 | 0,0035 | 0,62 | 0,0883 | 0,0028 | 0,62 | 0,0883 | 0,0044 |
| A22- | Floridsdorferbrücke | KN Gürtel Nordbrücke | 0,20 | 0,0352 | 0,0006 | 0,20 | 0,0352 | 0,0010 | 0,28 | 0,0493 | 0,0014 | 0,28 | 0,0493 | 0,0022 | 0,39 | 0,0563 | 0,0018 | 0,40 | 0,0563 | 0,0028 |
| A22- | KN Gürtel Nordbrücke | Strebendorf | 0,67 | 0,1203 | 0,0021 | 0,67 | 0,1203 | 0,0033 | 0,94 | 0,1684 | 0,0048 | 0,94 | 0,1684 | 0,0076 | 1,35 | 0,1925 | 0,0061 | 1,35 | 0,1925 | 0,0096 |
| A221 | Wien Nordbrücke | KN Gürtel Nordbrücke | 0,20 | 0,0355 | 0,0006 | 0,20 | 0,0355 | 0,0010 | 0,28 | 0,0497 | 0,0014 | 0,28 | 0,0497 | 0,0022 | 0,40 | 0,0568 | 0,0018 | 0,40 | 0,0568 | 0,0028 |
| A221 | KN Gürtel Nordbrücke | Wien Pragerstraße | 0,21 | 0,0382 | 0,0007 | 0,21 | 0,0382 | 0,0010 | 0,30 | 0,0535 | 0,0015 | 0,30 | 0,0535 | 0,0024 | 0,43 | 0,0611 | 0,0019 | 0,43 | 0,0611 | 0,0030 |
| A221 | Wien Pragerstraße | Wien Neujedlersdorf | 0,09 | 0,0167 | 0,0003 | 0,09 | 0,0167 | 0,0005 | 0,13 | 0,0234 | 0,0007 | 0,13 | 0,0234 | 0,0011 | 0,19 | 0,0268 | 0,0008 | 0,19 | 0,0268 | 0,0013 |
| A221 | Wien Neujedlersdorf | Brünnerstr/Shuttlewortstraße | 0,24 | 0,0424 | 0,0007 | 0,24 | 0,0424 | 0,0012 | 0,33 | 0,0594 | 0,0017 | 0,33 | 0,0594 | 0,0027 | 0,48 | 0,0678 | 0,0022 | 0,48 | 0,0678 | 0,0034 |
| A22- | Strebendorf | Korneuburg Ost | 1,35 | 0,2424 | 0,0042 | 1,35 | 0,2424 | 0,0067 | 1,90 | 0,3394 | 0,0098 | 1,90 | 0,3394 | 0,0153 | 2,72 | 0,3878 | 0,0123 | 2,73 | 0,3878 | 0,0193 |
| A222 | Strebendorf | Wien Vohburggasse | 0,17 | 0,0301 | 0,0005 | 0,17 | 0,0301 | 0,0008 | 0,24 | 0,0422 | 0,0012 | 0,24 | 0,0422 | 0,0019 | 0,34 | 0,0482 | 0,0015 | 0,34 | 0,0482 | 0,0024 |
| A22- | Korneuburg Ost | KN Korneuburg | 0,87 | 0,1564 | 0,0027 | 0,87 | 0,1564 | 0,0043 | 1,22 | 0,2190 | 0,0063 | 1,23 | 0,2190 | 0,0099 | 1,75 | 0,2503 | 0,0079 | 1,76 | 0,2503 | 0,0125 |
| A22- | KN Korneuburg | Stockerau Ost | 1,27 | 0,2276 | 0,0040 | 1,27 | 0,2276 | 0,0063 | 1,78 | 0,3186 | 0,0092 | 1,78 | 0,3186 | 0,0144 | 2,55 | 0,3642 | 0,0116 | 2,56 | 0,3642 | 0,0182 |
| A22- | Stockerau Ost | Stockerau Mitte | 0,51 | 0,0908 | 0,0016 | 0,51 | 0,0908 | 0,0025 | 0,71 | 0,1271 | 0,0037 | 0,71 | 0,1271 | 0,0057 | 1,02 | 0,1452 | 0,0046 | 1,02 | 0,1452 | 0,0072 |
| A22- | Stockerau Mitte | KN Stockerau/West | 0,43 | 0,0771 | 0,0013 | 0,43 | 0,0771 | 0,0021 | 0,60 | 0,1079 | 0,0031 | 0,60 | 0,1079 | 0,0049 | 0,86 | 0,1233 | 0,0039 | 0,87 | 0,1233 | 0,0061 |
| A23- | Altmannsdorferstraße | KN Wien Inzersdorf | 0,38 | 0,0674 | 0,0012 | 0,38 | 0,0674 | 0,0019 | 0,53 | 0,0944 | 0,0027 | 0,53 | 0,0944 | 0,0043 | 0,76 | 0,1079 | 0,0034 | 0,76 | 0,1079 | 0,0054 |
| A23- | KN Wien Inzersdorf | Favoriten | 0,95 | 0,1701 | 0,0030 | 0,95 | 0,1701 | 0,0047 | 1,33 | 0,2381 | 0,0068 | 1,33 | 0,2381 | 0,0108 | 1,91 | 0,2721 | 0,0086 | 1,91 | 0,2721 | 0,0136 |
| A23- | Favoriten | KN Gürtel Landstraßer Hauptstraße | 0,59 | 0,1065 | 0,0019 | 0,59 | 0,1065 | 0,0029 | 0,83 | 0,1491 | 0,0043 | 0,84 | 0,1491 | 0,0067 | 1,19 | 0,1704 | 0,0054 | 1,20 | 0,1704 | 0,0085 |
| A23- | KN Gürtel Landstraßer Hauptstraße | St. Marx | 0,23 | 0,0404 | 0,0007 | 0,23 | 0,0404 | 0,0011 | 0,32 | 0,0566 | 0,0016 | 0,32 | 0,0566 | 0,0026 | 0,45 | 0,0647 | 0,0021 | 0,45 | 0,0647 | 0,0032 |
| A23- | St. Marx | KN Wien Prater | 0,19 | 0,0343 | 0,0006 | 0,19 | 0,0343 | 0,0009 | 0,27 | 0,0480 | 0,0014 | 0,27 | 0,0480 | 0,0022 | 0,38 | 0,0549 | 0,0017 | 0,39 | 0,0549 | 0,0027 |
| A23- | KN Wien Prater | Handelskai | 0,42 | 0,0762 | 0,0013 | 0,43 | 0,0762 | 0,0021 | 0,60 | 0,1067 | 0,0031 | 0,60 | 0,1067 | 0,0048 | 0,85 | 0,1219 | 0,0039 | 0,86 | 0,1219 | 0,0061 |
| A23- | Handelskai | KN Wien Kaisermühlen | 0,19 | 0,0348 | 0,0006 | 0,19 | 0,0348 | 0,0010 | 0,27 | 0,0488 | 0,0014 | 0,27 | 0,0488 | 0,0022 | 0,39 | 0,0557 | 0,0018 | 0,39 | 0,0557 | 0,0028 |
| A23- | KN Wien Kaisermühlen | Groß Enzersdorf Stadlau | 0,53 | 0,0956 | 0,0017 | 0,53 | 0,0956 | 0,0026 | 0,75 | 0,1338 | 0,0038 | 0,75 | 0,1338 | 0,0060 | 1,07 | 0,1530 | 0,0049 | 1,08 | 0,1530 | 0,0076 |
| A23- | Groß Enzersdorf Stadlau | Hirschstetten | 0,30 | 0,0536 | 0,0009 | 0,30 | 0,0536 | 0,0015 | 0,42 | 0,0750 | 0,0022 | 0,42 | 0,0750 | 0,0034 | 0,60 | 0,0858 | 0,0027 | 0,60 | 0,0858 | 0,0043 |
| A233 | KN Gürtel Landstraßer Hauptstraße | Wien Gürtel | 0,17 | 0,0313 | 0,0005 | 0,17 | 0,0313 | 0,0009 | 0,24 | 0,0438 | 0,0013 | 0,25 | 0,0438 | 0,0020 | 0,35 | 0,0500 | 0,0016 | 0,35 | 0,0500 | 0,0025 |
| A25- | KN A1/A25 Passau Wels | Weißkirchen | 1,96 | 0,3526 | 0,0062 | 1,97 | 0,3526 | 0,0097 | 2,76 | 0,4936 | 0,0142 | 2,76 | 0,4936 | 0,0223 | 3,95 | 0,5642 | 0,0179 | 3,97 | 0,5642 | 0,0281 |
| A25- | Weißkirchen | Marchtrenk Wels Ost | 0,70 | 0,1256 | 0,0022 | 0,70 | 0,1256 | 0,0035 | 0,98 | 0,1759 | 0,0051 | 0,99 | 0,1759 | 0,0079 | 1,41 | 0,2010 | 0,0064 | 1,41 | 0,2010 | 0,0100 |
| A25- | Marchtrenk Wels Ost | ÖBB Terminal Wels | 0,19 | 0,0338 | 0,0006 | 0,19 | 0,0338 | 0,0009 | 0,26 | 0,0473 | 0,0014 | 0,26 | 0,0473 | 0,0021 | 0,38 | 0,0541 | 0,0017 | 0,38 | 0,0541 | 0,0027 |

| | | | | | | | | | | | | | | | | | | | | |
|------|-----------------------------------|-----------------------------------|------|--------|--------|------|--------|--------|------|--------|--------|------|--------|--------|------|--------|--------|------|----------|--------|
| S01- | Seyring | KN Eibesbrunn | 0,92 | 0,1649 | 0,0029 | 0,92 | 0,1649 | 0,0045 | 1,29 | 0,2308 | 0,0066 | 1,29 | 0,2308 | 0,0104 | 1,85 | 0,2638 | 0,0084 | 1,85 | 0,2638 | 0,0131 |
| S01- | KN Eibesbrunn | Hagenbrunn | 0,72 | 0,1298 | 0,0023 | 0,72 | 0,1298 | 0,0036 | 1,01 | 0,1817 | 0,0052 | 1,02 | 0,1817 | 0,0082 | 1,46 | 0,2077 | 0,0066 | 1,46 | 0,2077 | 0,0104 |
| S01- | Hagenbrunn | Korneuburg Nord | 1,55 | 0,2777 | 0,0049 | 1,55 | 0,2777 | 0,0076 | 2,17 | 0,3888 | 0,0112 | 2,18 | 0,3888 | 0,0176 | 3,11 | 0,4443 | 0,0141 | 3,12 | 0,4443 | 0,0221 |
| S01- | Korneuburg Nord | Korneuburg West | 0,63 | 0,1126 | 0,0020 | 0,63 | 0,1126 | 0,0031 | 0,88 | 0,1577 | 0,0045 | 0,88 | 0,1577 | 0,0071 | 1,26 | 0,1802 | 0,0057 | 1,27 | 0,1802 | 0,0090 |
| S01- | Korneuburg West | KN Korneuburg | 0,20 | 0,0359 | 0,0006 | 0,20 | 0,0359 | 0,0010 | 0,28 | 0,0503 | 0,0014 | 0,28 | 0,0503 | 0,0023 | 0,40 | 0,0575 | 0,0018 | 0,40 | 0,0575 | 0,0029 |
| S02- | Hirschstetten | Gewerbepark Stadlau | 0,22 | 0,0386 | 0,0007 | 0,22 | 0,0386 | 0,0011 | 0,30 | 0,0540 | 0,0016 | 0,30 | 0,0540 | 0,0024 | 0,43 | 0,0618 | 0,0020 | 0,43 | 0,0618 | 0,0031 |
| S02- | Gewerbepark Stadlau | Breitenleer Straße | 0,12 | 0,0214 | 0,0004 | 0,12 | 0,0214 | 0,0006 | 0,17 | 0,0300 | 0,0009 | 0,17 | 0,0300 | 0,0014 | 0,24 | 0,0342 | 0,0011 | 0,24 | 0,0342 | 0,0017 |
| S02- | Breitenleer Straße | Rautenweg | 0,20 | 0,0355 | 0,0006 | 0,20 | 0,0355 | 0,0010 | 0,28 | 0,0497 | 0,0014 | 0,28 | 0,0497 | 0,0022 | 0,40 | 0,0568 | 0,0018 | 0,40 | 0,0568 | 0,0028 |
| S02- | Rautenweg | Hermann Gebauer Straße | 0,22 | 0,0390 | 0,0007 | 0,22 | 0,0390 | 0,0011 | 0,31 | 0,0547 | 0,0016 | 0,31 | 0,0547 | 0,0025 | 0,44 | 0,0625 | 0,0020 | 0,44 | 0,0625 | 0,0031 |
| S02- | Hermann Gebauer Straße | Angerner Straße | 0,79 | 0,1413 | 0,0025 | 0,79 | 0,1413 | 0,0039 | 1,10 | 0,1978 | 0,0057 | 1,11 | 0,1978 | 0,0089 | 1,58 | 0,2260 | 0,0072 | 1,59 | 0,2260 | 0,0113 |
| S03- | KN Stockerau/West | Stockerau Nord | 0,22 | 0,0399 | 0,0007 | 0,22 | 0,0399 | 0,0011 | 0,31 | 0,0559 | 0,0016 | 0,31 | 0,0559 | 0,0025 | 0,45 | 0,0639 | 0,0020 | 0,45 | 0,0639 | 0,0032 |
| S03- | Stockerau Nord | Sierndorf | 1,20 | 0,2146 | 0,0038 | 1,20 | 0,2146 | 0,0059 | 1,68 | 0,3004 | 0,0086 | 1,68 | 0,3004 | 0,0136 | 2,41 | 0,3433 | 0,0109 | 2,41 | 0,3433 | 0,0171 |
| S03- | Sierndorf | Obermallebarn | 0,80 | 0,1441 | 0,0025 | 0,80 | 0,1441 | 0,0040 | 1,13 | 0,2017 | 0,0058 | 1,13 | 0,2017 | 0,0091 | 1,62 | 0,2305 | 0,0073 | 1,62 | 0,2305 | 0,0115 |
| S03- | Obermallebarn | Göllersdorf | 1,06 | 0,1902 | 0,0033 | 1,06 | 0,1902 | 0,0052 | 1,49 | 0,2663 | 0,0077 | 1,49 | 0,2663 | 0,0120 | 2,13 | 0,3044 | 0,0097 | 2,14 | 0,3044 | 0,0152 |
| S03- | Göllersdorf | Großstelzendorf | 0,42 | 0,0762 | 0,0013 | 0,43 | 0,0762 | 0,0021 | 0,60 | 0,1067 | 0,0031 | 0,60 | 0,1067 | 0,0048 | 0,85 | 0,1219 | 0,0039 | 0,86 | 0,1219 | 0,0061 |
| S03- | Großstelzendorf | Hollabrunn Süd | 1,02 | 0,1832 | 0,0032 | 1,02 | 0,1832 | 0,0050 | 1,43 | 0,2565 | 0,0074 | 1,44 | 0,2565 | 0,0116 | 2,06 | 0,2932 | 0,0093 | 2,06 | 0,2932 | 0,0146 |
| S04- | KN Mattersburg | Sigleß | 0,53 | 0,0947 | 0,0017 | 0,53 | 0,0947 | 0,0026 | 0,74 | 0,1326 | 0,0038 | 0,74 | 0,1326 | 0,0060 | 1,06 | 0,1516 | 0,0048 | 1,07 | 0,1516 | 0,0076 |
| S04- | Sigleß | Bad Sauerbrunn | 1,23 | 0,2213 | 0,0039 | 1,24 | 0,2213 | 0,0061 | 1,73 | 0,3098 | 0,0089 | 1,74 | 0,3098 | 0,0140 | 2,48 | 0,3541 | 0,0112 | 2,49 | 0,3541 | 0,0177 |
| S04- | Bad Sauerbrunn | Neudörfel | 0,52 | 0,0930 | 0,0016 | 0,52 | 0,0930 | 0,0026 | 0,73 | 0,1302 | 0,0037 | 0,73 | 0,1302 | 0,0059 | 1,04 | 0,1488 | 0,0047 | 1,05 | 0,1488 | 0,0074 |
| S04- | Neudörfel | Wr. Neustadt Ost | 0,54 | 0,0974 | 0,0017 | 0,54 | 0,0974 | 0,0027 | 0,76 | 0,1363 | 0,0039 | 0,76 | 0,1363 | 0,0062 | 1,09 | 0,1558 | 0,0049 | 1,09 | 0,1558 | 0,0078 |
| S04- | Wr. Neustadt Ost | Katzelsdorf | 0,25 | 0,0456 | 0,0008 | 0,25 | 0,0456 | 0,0013 | 0,36 | 0,0638 | 0,0018 | 0,36 | 0,0638 | 0,0029 | 0,51 | 0,0730 | 0,0023 | 0,51 | 0,0730 | 0,0036 |
| S04- | Katzelsdorf | Lanzenkirchen | 0,21 | 0,0382 | 0,0007 | 0,21 | 0,0382 | 0,0010 | 0,30 | 0,0534 | 0,0015 | 0,30 | 0,0534 | 0,0024 | 0,43 | 0,0611 | 0,0019 | 0,43 | 0,0611 | 0,0030 |
| S04- | Lanzenkirchen | Wr. Neustadt Süd | 0,19 | 0,0338 | 0,0006 | 0,19 | 0,0338 | 0,0009 | 0,26 | 0,0474 | 0,0014 | 0,27 | 0,0474 | 0,0021 | 0,38 | 0,0541 | 0,0017 | 0,38 | 0,0541 | 0,0027 |
| S04- | Wr. Neustadt Süd | KN Wr. Neustadt | 0,31 | 0,0560 | 0,0010 | 0,31 | 0,0560 | 0,0015 | 0,44 | 0,0784 | 0,0023 | 0,44 | 0,0784 | 0,0035 | 0,63 | 0,0896 | 0,0028 | 0,63 | 0,0896 | 0,0045 |
| S05- | KN Stockerau/West | Tulln | 2,15 | 0,3864 | 0,0068 | 2,16 | 0,3864 | 0,0106 | 3,02 | 0,5410 | 0,0156 | 3,03 | 0,5410 | 0,0244 | 4,33 | 0,6182 | 0,0196 | 4,35 | 0,6182 | 0,0308 |
| S05- | Tulln | Königsbrunn / Wagram | 2,70 | 0,4840 | 0,0085 | 2,70 | 0,4840 | 0,0133 | 3,78 | 0,6776 | 0,0195 | 3,79 | 0,6776 | 0,0306 | 5,43 | 0,7744 | 0,0246 | 5,44 | 0,7744 | 0,0386 |
| S05- | Königsbrunn / Wagram | Kirchberg/Wagram | 0,72 | 0,1290 | 0,0023 | 0,72 | 0,1290 | 0,0035 | 1,01 | 0,1806 | 0,0052 | 1,01 | 0,1806 | 0,0082 | 1,45 | 0,2064 | 0,0065 | 1,45 | 0,2064 | 0,0103 |
| S05- | Kirchberg/Wagram | Fels / Wagram | 0,54 | 0,0966 | 0,0017 | 0,54 | 0,0966 | 0,0027 | 0,76 | 0,1353 | 0,0039 | 0,76 | 0,1353 | 0,0061 | 1,08 | 0,1546 | 0,0049 | 1,09 | 0,1546 | 0,0077 |
| S05- | Fels / Wagram | Grafenwörth | 1,24 | 0,2225 | 0,0039 | 1,24 | 0,2225 | 0,0061 | 1,74 | 0,3115 | 0,0090 | 1,74 | 0,3115 | 0,0141 | 2,50 | 0,3560 | 0,0113 | 2,50 | 0,3560 | 0,0177 |
| S05- | Grafenwörth | Jettsdorf | 0,55 | 0,0995 | 0,0017 | 0,56 | 0,0995 | 0,0027 | 0,78 | 0,1393 | 0,0040 | 0,78 | 0,1393 | 0,0063 | 1,12 | 0,1592 | 0,0050 | 1,12 | 0,1592 | 0,0079 |
| S06- | KN Seebein | Neunkirchen | 0,85 | 0,1518 | 0,0027 | 0,85 | 0,1518 | 0,0042 | 1,19 | 0,2125 | 0,0061 | 1,19 | 0,2125 | 0,0096 | 1,70 | 0,2429 | 0,0077 | 1,71 | 0,2429 | 0,0121 |
| S06- | Neunkirchen | Gloggnitz | 2,71 | 0,4868 | 0,0085 | 2,72 | 0,4868 | 0,0134 | 3,81 | 0,6815 | 0,0196 | 3,82 | 0,6815 | 0,0308 | 5,46 | 0,7789 | 0,0247 | 5,47 | 0,7789 | 0,0388 |
| S06- | Gloggnitz | Maria Schutz | 1,73 | 0,3103 | 0,0054 | 1,73 | 0,3103 | 0,0085 | 2,43 | 0,4344 | 0,0125 | 2,43 | 0,4344 | 0,0196 | 3,48 | 0,4964 | 0,0157 | 3,49 | 0,4964 | 0,0247 |
| S06- | Maria Schutz | Spital / Semmering | 1,47 | 0,2634 | 0,0046 | 1,47 | 0,2634 | 0,0072 | 2,06 | 0,3687 | 0,0106 | 2,06 | 0,3687 | 0,0167 | 2,95 | 0,4214 | 0,0134 | 2,96 | 0,4214 | 0,0210 |
| S06- | Spital / Semmering | Mürzzuschlag Ost | 1,23 | 0,2200 | 0,0039 | 1,23 | 0,2200 | 0,0061 | 1,72 | 0,3080 | 0,0089 | 1,72 | 0,3080 | 0,0139 | 2,47 | 0,3520 | 0,0112 | 2,47 | 0,3520 | 0,0175 |
| S06- | Mürzzuschlag Ost | Mariazell, Mürzsteg, Mürzzuschlag | 1,09 | 0,1950 | 0,0034 | 1,09 | 0,1950 | 0,0054 | 1,52 | 0,2731 | 0,0079 | 1,53 | 0,2731 | 0,0123 | 2,19 | 0,3121 | 0,0099 | 2,19 | 0,3121 | 0,0156 |
| S06- | Mariazell, Mürzsteg, Mürzzuschlag | Hönigsberg | 0,78 | 0,1391 | 0,0024 | 0,78 | 0,1391 | 0,0038 | 1,09 | 0,1947 | 0,0056 | 1,09 | 0,1947 | 0,0088 | 1,56 | 0,2225 | 0,0071 | 1,56 | 0,2225 | 0,0111 |
| S06- | Hönigsberg | Langenwang | 0,43 | 0,0769 | 0,0013 | 0,43 | 0,0769 | 0,0021 | 0,60 | 0,1077 | 0,0031 | 0,60 | 0,1077 | 0,0049 | 0,86 | 0,1231 | 0,0039 | 0,87 | 0,1231 | 0,0061 |
| S06- | Langenwang | Krieglach | 0,51 | 0,0914 | 0,0016 | 0,51 | 0,0914 | 0,0025 | 0,71 | 0,1279 | 0,0037 | 0,72 | 0,1279 | 0,0058 | 1,02 | 0,1462 | 0,0046 | 1,03 | 0,1462 | 0,0073 |
| S06- | Krieglach | Mitterdorf | 1,29 | 0,2309 | 0,0040 | 1,29 | 0,2309 | 0,0064 | 1,81 | 0,3233 | 0,0093 | 1,81 | 0,3233 | 0,0146 | 2,59 | 0,3695 | 0,0117 | 2,60 | 0,3695 | 0,0184 |
| S06- | Mitterdorf | Kindberg Ost | 1,31 | 0,2348 | 0,0041 | 1,31 | 0,2348 | 0,0065 | 1,84 | 0,3287 | 0,0095 | 1,84 | 0,3287 | 0,0149 | 2,63 | 0,3757 | 0,0119 | 2,64 | 0,3757 | 0,0187 |
| S06- | Kindberg Ost | Kindberg West | 0,28 | 0,0504 | 0,0009 | 0,28 | 0,0504 | 0,0014 | 0,39 | 0,0706 | 0,0020 | 0,40 | 0,0706 | 0,0032 | 0,57 | 0,0806 | 0,0026 | 0,57 | 0,0806 | 0,0040 |
| S06- | Kindberg West | Kindberg Dörfel | 0,28 | 0,0504 | 0,0009 | 0,28 | 0,0504 | 0,0014 | 0,39 | 0,0705 | 0,0020 | 0,39 | 0,0705 | 0,0032 | 0,56 | 0,0806 | 0,0026 | 0,57 | 0,0806 | 0,0040 |
| S06- | Kindberg Dörfel | Allerheiligen Mürzhofen | 0,63 | 0,1134 | 0,0020 | 0,63 | 0,1134 | 0,0031 | 0,89 | 0,1588 | 0,0046 | 0,89 | 0,1588 | 0,0072 | 1,27 | 0,1815 | 0,0058 | 1,28 | 0,1815 | 0,0090 |
| S06- | Allerheiligen Mürzhofen | St. Marein | 0,95 | 0,1704 | 0,0030 | 0,95 | 0,1704 | 0,0047 | 1,33 | 0,2386 | 0,0069 | 1,34 | 0,2386 | 0,0108 | 1,91 | 0,2726 | 0,0086 | 1,92 | 0,2726 | 0,0136 |
| S06- | St. Marein | Kapfenberg | 0,67 | 0,1208 | 0,0021 | 0,67 | 0,1208 | 0,0033 | 0,94 | 0,1691 | 0,0049 | 0,95 | 0,1691 | 0,0076 | 1,35 | 0,1933 | 0,0061 | 1,36 | 0,1933 | 0,0096 |
| S06- | Kapfenberg | KN Bruck/Mur | 1,26 | 0,2255 | 0,0039 | 1,26 | 0,2255 | 0,0062 | 1,76 | 0,3157 | 0,0091 | 1,77 | 0,3157 | 0,0143 | 2,53 | 0,3608 | 0,0114 | 2,54 | 0,3608 | 0,0180 |
| S06- | KN Bruck/Mur | ASt Bruck/Mur | 1,08 | 0,1934 | 0,0034 | 1,08 | 0,1934 | 0,0053 | 1,51 | 0,2708 | 0,0078 | 1,52 | 0,2708 | 0,0122 | 2,17 | 0,3095 | 0,0098 | 2,18 | 0,3095 | 0,0154 |
| S06- | ASt Bruck/Mur | Niklasdorf | 1,00 | 0,1787 | 0,0031 | 1,00 | 0,1787 | 0,0049 | 1,40 | 0,2502 | 0,0072 | 1,40 | 0,2502 | 0,0113 | 2,00 | 0,2860 | 0,0091 | 2,01 | 0,2860 | 0,0143 |
| S06- | Niklasdorf | Leoben Ost | 1,06 | 0,1906 | 0,0033 | 1,06 | 0,1906 | 0,0052 | 1,49 | 0,2669 | 0,0077 | 1,49 | 0,2669 | 0,0121 | 2,14 | 0,3050 | 0,0097 | 2,14 | 0,3050 | 0,0152 |
| S06- | Leoben Ost | Leoben West | 1,19 | 0,2136 | 0,0037 | 1,19 | 0,2136 | 0,0059 | 1,67 | 0,2990 | 0,0086 | 1,67 | 0,2990 | 0,0135 | 2,40 | 0,3417 | 0,0108 | 2,40 | 0,3417</ | |

| | | | | | | | | | | | | | | | | | | | | |
|------|-----------------------------|-----------------------------|------|--------|--------|------|--------|--------|------|--------|--------|------|--------|--------|------|--------|----------|------|--------|--------|
| S31- | Eisenstadt Mitte | KN Eisenstadt | 0,42 | 0,0761 | 0,0013 | 0,42 | 0,0761 | 0,0021 | 0,59 | 0,1065 | 0,0031 | 0,60 | 0,1065 | 0,0048 | 0,85 | 0,1217 | 0,0039 | 0,86 | 0,1217 | 0,0061 |
| S31- | KN Eisenstadt | Wulkaprodersdorf | 0,56 | 0,1013 | 0,0018 | 0,57 | 0,1013 | 0,0028 | 0,79 | 0,1418 | 0,0041 | 0,79 | 0,1418 | 0,0064 | 1,14 | 0,1620 | 0,0051 | 1,14 | 0,1620 | 0,0081 |
| S31- | Wulkaprodersdorf | KN Mattersburg | 1,60 | 0,2875 | 0,0050 | 1,61 | 0,2875 | 0,0079 | 2,25 | 0,4025 | 0,0116 | 2,25 | 0,4025 | 0,0182 | 3,22 | 0,4600 | 0,0146 | 3,23 | 0,4600 | 0,0229 |
| S31- | KN Mattersburg | Forchtenstein | 1,16 | 0,2081 | 0,0036 | 1,16 | 0,2081 | 0,0057 | 1,63 | 0,2914 | 0,0084 | 1,63 | 0,2914 | 0,0132 | 2,33 | 0,3330 | 0,0106 | 2,34 | 0,3330 | 0,0166 |
| S31- | Forchtenstein | Sieggraben | 1,62 | 0,2908 | 0,0051 | 1,62 | 0,2908 | 0,0080 | 2,27 | 0,4071 | 0,0117 | 2,28 | 0,4071 | 0,0184 | 3,26 | 0,4653 | 0,0148 | 3,27 | 0,4653 | 0,0232 |
| S31- | Sieggraben | Weppersdorf/Kobersdorf | 1,95 | 0,3503 | 0,0061 | 1,96 | 0,3503 | 0,0096 | 2,74 | 0,4904 | 0,0141 | 2,75 | 0,4904 | 0,0222 | 3,93 | 0,5605 | 0,0178 | 3,94 | 0,5605 | 0,0279 |
| S31- | Weppersdorf/Kobersdorf | Weppersdorf/Markt St.Martin | 0,40 | 0,0720 | 0,0013 | 0,40 | 0,0720 | 0,0020 | 0,56 | 0,1007 | 0,0029 | 0,56 | 0,1007 | 0,0046 | 0,81 | 0,1151 | 0,0037 | 0,81 | 0,1151 | 0,0057 |
| S31- | Weppersdorf/Markt St.Martin | Neutal | 0,93 | 0,1663 | 0,0029 | 0,93 | 0,1663 | 0,0046 | 1,30 | 0,2328 | 0,0067 | 1,30 | 0,2328 | 0,0105 | 1,87 | 0,2660 | 0,0084 | 1,87 | 0,2660 | 0,0133 |
| S31- | Neutal | Stoob Süd | 0,81 | 0,1453 | 0,0025 | 0,81 | 0,1453 | 0,0040 | 1,14 | 0,2034 | 0,0058 | 1,14 | 0,2034 | 0,0092 | 1,63 | 0,2324 | 0,0074 | 1,63 | 0,2324 | 0,0116 |
| S31- | Stoob Süd | Oberpullendorf | 0,88 | 0,1586 | 0,0028 | 0,89 | 0,1586 | 0,0044 | 1,24 | 0,2220 | 0,0064 | 1,24 | 0,2220 | 0,0100 | 1,78 | 0,2538 | 0,0080 | 1,78 | 0,2538 | 0,0126 |
| S33- | KN St. Pölten | St. Pölten Ost | 0,48 | 0,0861 | 0,0015 | 0,48 | 0,0861 | 0,0024 | 0,67 | 0,1205 | 0,0035 | 0,67 | 0,1205 | 0,0054 | 0,97 | 0,1377 | 0,0044 | 0,97 | 0,1377 | 0,0069 |
| S33- | St. Pölten Ost | St. Pölten Nord | 0,85 | 0,1521 | 0,0027 | 0,85 | 0,1521 | 0,0042 | 1,19 | 0,2130 | 0,0061 | 1,19 | 0,2130 | 0,0096 | 1,71 | 0,2434 | 0,0077 | 1,71 | 0,2434 | 0,0121 |
| S33- | St. Pölten Nord | Herzogenburg Süd | 0,90 | 0,1611 | 0,0028 | 0,90 | 0,1611 | 0,0044 | 1,26 | 0,2255 | 0,0065 | 1,26 | 0,2255 | 0,0102 | 1,81 | 0,2577 | 0,0082 | 1,81 | 0,2577 | 0,0128 |
| S33- | Herzogenburg Süd | Herzogenburg Stadt | 0,48 | 0,0860 | 0,0015 | 0,48 | 0,0860 | 0,0024 | 0,67 | 0,1204 | 0,0035 | 0,67 | 0,1204 | 0,0054 | 0,96 | 0,1376 | 0,0044 | 0,97 | 0,1376 | 0,0069 |
| S33- | Herzogenburg Stadt | Herzogenburg Nord | 0,27 | 0,0477 | 0,0008 | 0,27 | 0,0477 | 0,0013 | 0,37 | 0,0668 | 0,0019 | 0,37 | 0,0668 | 0,0030 | 0,53 | 0,0763 | 0,0024 | 0,54 | 0,0763 | 0,0038 |
| S33- | Herzogenburg Nord | Traismauer Süd | 1,29 | 0,2320 | 0,0041 | 1,30 | 0,2320 | 0,0064 | 1,81 | 0,3249 | 0,0093 | 1,82 | 0,3249 | 0,0147 | 2,60 | 0,3713 | 0,0118 | 2,61 | 0,3713 | 0,0185 |
| S33- | Traismauer Süd | Traismauer Nord | 0,66 | 0,1180 | 0,0021 | 0,66 | 0,1180 | 0,0032 | 0,92 | 0,1652 | 0,0047 | 0,93 | 0,1652 | 0,0075 | 1,32 | 0,1888 | 0,0060 | 1,33 | 0,1888 | 0,0094 |
| S33- | Traismauer Nord | Jettsdorf | 1,11 | 0,1993 | 0,0035 | 1,11 | 0,1993 | 0,0055 | 1,56 | 0,2790 | 0,0080 | 1,56 | 0,2790 | 0,0126 | 2,24 | 0,3188 | 0,0101 | 2,24 | 0,3188 | 0,0159 |
| S35- | KN Bruck/Mur | Pernegg | 1,36 | 0,2436 | 0,0043 | 1,36 | 0,2436 | 0,0067 | 1,90 | 0,3410 | 0,0098 | 1,91 | 0,3410 | 0,0154 | 2,73 | 0,3898 | 0,0124 | 2,74 | 0,3898 | 0,0194 |
| S35- | Pernegg | Mixnitz/Mautstatt | 0,99 | 0,1772 | 0,0031 | 0,99 | 0,1772 | 0,0049 | 1,38 | 0,2480 | 0,0071 | 1,39 | 0,2480 | 0,0112 | 1,99 | 0,2835 | 0,0090 | 1,99 | 0,2835 | 0,0141 |
| S35- | Mixnitz/Mautstatt | Röthelstein | 1,18 | 0,2124 | 0,0037 | 1,19 | 0,2124 | 0,0058 | 1,66 | 0,2974 | 0,0085 | 1,67 | 0,2974 | 0,0134 | 2,38 | 0,3398 | 0,0108 | 2,39 | 0,3398 | 0,0169 |
| S35- | Röthelstein | Laufnitzdorf | 0,57 | 0,1024 | 0,0018 | 0,57 | 0,1024 | 0,0028 | 0,80 | 0,1433 | 0,0041 | 0,80 | 0,1433 | 0,0065 | 1,15 | 0,1638 | 0,0052 | 1,15 | 0,1638 | 0,0082 |
| S35- | Laufnitzdorf | Rothleiten | 0,65 | 0,1164 | 0,0020 | 0,65 | 0,1164 | 0,0032 | 0,91 | 0,1629 | 0,0047 | 0,91 | 0,1629 | 0,0074 | 1,31 | 0,1862 | 0,0059 | 1,31 | 0,1862 | 0,0093 |
| S35- | Rothleiten | Frohnleiten Nord | 0,40 | 0,0725 | 0,0013 | 0,40 | 0,0725 | 0,0020 | 0,57 | 0,1015 | 0,0029 | 0,57 | 0,1015 | 0,0046 | 0,81 | 0,1160 | 0,0037 | 0,82 | 0,1160 | 0,0058 |
| S35- | Frohnleiten Nord | Frohnleiten | 0,19 | 0,0334 | 0,0006 | 0,19 | 0,0334 | 0,0009 | 0,26 | 0,0468 | 0,0013 | 0,26 | 0,0468 | 0,0021 | 0,38 | 0,0535 | 0,0017 | 0,38 | 0,0535 | 0,0027 |
| S35- | Frohnleiten | Badl Peggau | 1,25 | 0,2248 | 0,0039 | 1,26 | 0,2248 | 0,0062 | 1,76 | 0,3147 | 0,0090 | 1,76 | 0,3147 | 0,0142 | 2,52 | 0,3597 | 0,0114 | 2,53 | 0,3597 | 0,0179 |
| S35- | Badl Peggau | Peggau Mitte | 0,42 | 0,0752 | 0,0013 | 0,42 | 0,0752 | 0,0021 | 0,59 | 0,1053 | 0,0030 | 0,59 | 0,1053 | 0,0048 | 0,84 | 0,1203 | 0,0038 | 0,85 | 0,1203 | 0,0060 |
| S35- | Peggau Mitte | KN Peggau Deutschfeistritz | 0,87 | 0,1566 | 0,0027 | 0,87 | 0,1566 | 0,0043 | 1,22 | 0,2192 | 0,0063 | 1,23 | 0,2192 | 0,0099 | 1,76 | 0,2506 | 0,0079 | 1,76 | 0,2506 | 0,0125 |
| S36- | KN St. Michael | St. Stefan ob Leoben | 0,72 | 0,1290 | 0,0023 | 0,72 | 0,1290 | 0,0035 | 1,01 | 0,1806 | 0,0052 | 1,01 | 0,1806 | 0,0082 | 1,45 | 0,2064 | 0,0065 | 1,45 | 0,2064 | 0,0103 |
| S36- | St. Stefan ob Leoben | Kraubath | 0,77 | 0,1386 | 0,0024 | 0,77 | 0,1386 | 0,0038 | 1,08 | 0,1940 | 0,0056 | 1,09 | 0,1940 | 0,0088 | 1,55 | 0,2218 | 0,0070 | 1,56 | 0,2218 | 0,0111 |
| S36- | Kraubath | Feistritz St. Lorenzen | 1,36 | 0,2435 | 0,0043 | 1,36 | 0,2435 | 0,0067 | 1,90 | 0,3409 | 0,0098 | 1,91 | 0,3409 | 0,0154 | 2,73 | 0,3896 | 0,0124 | 2,74 | 0,3896 | 0,0194 |
| S36- | Feistritz St. Lorenzen | Knittelfeld Ost | 1,56 | 0,2795 | 0,0049 | 1,56 | 0,2795 | 0,0077 | 2,18 | 0,3913 | 0,0112 | 2,19 | 0,3913 | 0,0177 | 3,13 | 0,4472 | 0,0142 | 3,14 | 0,4472 | 0,0223 |
| S36- | Knittelfeld Ost | Knittelfeld West | 0,66 | 0,1185 | 0,0021 | 0,66 | 0,1185 | 0,0033 | 0,93 | 0,1659 | 0,0048 | 0,93 | 0,1659 | 0,0075 | 1,33 | 0,1896 | 0,0060 | 1,33 | 0,1896 | 0,0095 |
| S36- | Knittelfeld West | Zeitweg Ost Spielberg | 0,21 | 0,0370 | 0,0006 | 0,21 | 0,0370 | 0,0010 | 0,29 | 0,0518 | 0,0015 | 0,29 | 0,0518 | 0,0023 | 0,42 | 0,0592 | 0,0019 | 0,42 | 0,0592 | 0,0030 |
| S36- | Zeitweg Ost Spielberg | Zeitweg West | 1,34 | 0,2408 | 0,0042 | 1,34 | 0,2408 | 0,0066 | 1,88 | 0,3371 | 0,0097 | 1,89 | 0,3371 | 0,0152 | 2,70 | 0,3853 | 0,0122 | 2,71 | 0,3853 | 0,0192 |
| S36- | Zeitweg West | Judenburg Ost Fohnsdorf | 0,67 | 0,1211 | 0,0021 | 0,68 | 0,1211 | 0,0033 | 0,95 | 0,1695 | 0,0049 | 0,95 | 0,1695 | 0,0077 | 1,36 | 0,1937 | 0,0061 | 1,36 | 0,1937 | 0,0097 |
| S36- | Judenburg Ost Fohnsdorf | Judenburg West | 1,05 | 0,1878 | 0,0033 | 1,05 | 0,1878 | 0,0052 | 1,47 | 0,2630 | 0,0076 | 1,47 | 0,2630 | 0,0119 | 2,11 | 0,3005 | 0,0095 | 2,11 | 0,3005 | 0,0150 |
| S36- | As B317 (prov.) | St. Georgen Ost | 0,11 | 0,0196 | 0,0003 | 0,11 | 0,0196 | 0,0005 | 0,15 | 0,0275 | 0,0008 | 0,15 | 0,0275 | 0,0012 | 0,22 | 0,0314 | 0,0010 | 0,22 | 0,0314 | 0,0016 |
| S36- | St. Georgen Ost | St. Georgen West | 0,20 | 0,0364 | 0,0006 | 0,20 | 0,0364 | 0,0010 | 0,28 | 0,0509 | 0,0015 | 0,29 | 0,0509 | 0,0023 | 0,41 | 0,0582 | 0,0018 | 0,41 | 0,0582 | 0,0029 |
| S37- | St. Veit Nord | St. Veit Mitte / Brückl | 0,63 | 0,1139 | 0,0020 | 0,64 | 0,1139 | 0,0031 | 0,89 | 0,1595 | 0,0046 | 0,89 | 0,1595 | 0,0072 | 1,28 | 0,1823 | 0,0058 | 1,28 | 0,1823 | 0,0091 |
| S37- | St. Veit Mitte / Brückl | St. Veit Süd | 0,54 | 0,0968 | 0,0017 | 0,54 | 0,0968 | 0,0027 | 0,76 | 0,1356 | 0,0039 | 0,76 | 0,1356 | 0,0061 | 1,09 | 0,1549 | 0,0049 | 1,09 | 0,1549 | 0,0077 |
| S37- | St. Veit Süd | St. Veit Industriegebiet | 0,41 | 0,0728 | 0,0013 | 0,41 | 0,0728 | 0,0020 | 0,57 | 0,1019 | 0,0029 | 0,57 | 0,1019 | 0,0046 | 0,82 | 0,1165 | 0,0037 | 0,82 | 0,1165 | 0,0058 |
| S37- | St. Veit Industriegebiet | Maria Saal | 1,42 | 0,2555 | 0,0045 | 1,43 | 0,2555 | 0,0070 | 2,00 | 0,3577 | 0,0103 | 2,00 | 0,3577 | 0,0162 | 2,87 | 0,4088 | 0,0130 | 2,87 | 0,4088 | 0,0204 |
| S37- | Maria Saal | Karnburg | 0,51 | 0,0912 | 0,0016 | 0,51 | 0,0912 | 0,0025 | 0,71 | 0,1277 | 0,0037 | 0,72 | 0,1277 | 0,0058 | 1,02 | 0,1460 | 0,0046 | 1,03 | 0,1460 | 0,0073 |
| S37- | Karnburg | Klagenfurt Nord | 0,44 | 0,0796 | 0,0014 | 0,44 | 0,0796 | 0,0022 | 0,62 | 0,1115 | 0,0032 | 0,62 | 0,1115 | 0,0050 | 0,89 | 0,1274 | 0,0040 | 0,90 | 0,1274 | 0,0064 |
| A01- | Preßbaum | Wien Auhof | 3,11 | 0,5572 | 0,0098 | 3,11 | 0,5572 | 0,0153 | 4,36 | 0,7801 | 0,0224 | 4,37 | 0,7801 | 0,0352 | 6,25 | 0,8915 | 0,0283 | 6,27 | 0,8915 | 0,0444 |
| A01- | KN Steinhäusl | Preßbaum | 1,75 | 0,3149 | 0,0055 | 1,76 | 0,3149 | 0,0087 | 2,46 | 0,4408 | 0,0127 | 2,47 | 0,4408 | 0,0199 | 3,53 | 0,5038 | 0,0160 | 3,54 | 0,5038 | 0,0251 |
| A01- | Alltengbach | KN Steinhäusl | 1,03 | 0,1851 | 0,0032 | 1,03 | 0,1851 | 0,0051 | 1,45 | 0,2592 | 0,0075 | 1,45 | 0,2592 | 0,0117 | 2,08 | 0,2962 | 0,0094 | 2,08 | 0,2962 | 0,0148 |
| A01- | St. Christophen | Alltengbach | 1,23 | 0,2208 | 0,0039 | 1,23 | 0,2208 | 0,0061 | 1,73 | 0,3091 | 0,0089 | 1,73 | 0,3091 | 0,0140 | 2,48 | 0,3532 | 0,0112 | 2,48 | 0,3532 | 0,0176 |
| A01- | Böheimkirchen | St. Christophen | 1,48 | 0,2648 | 0,0046 | 1,48 | 0,2648 | 0,0073 | 2,07 | 0,3707 | 0,0107 | 2,08 | 0,3707 | 0,0167 | 2,97 | 0,4236 | 0,0134 | 2,98 | 0,4236 | 0,0211 |
| A01- | KN St. Pölten | Böheimkirchen | 1,44 | 0,2590 | 0,0045 | 1,45 | 0,2590 | 0,0071 | 2,02 | 0,3626 | 0,0104 | 2,03 | 0,3626 | 0,0164 | 2,91 | 0,4144 | 0,0131</ | | | |

| | | | | | | | | | | | | | | | | | | | | |
|------|----------------------------|----------------------------|------|--------|--------|------|--------|--------|------|--------|--------|------|--------|--------|------|--------|--------|------|--------|--------|
| A01- | Laakirchen West | Laakirchen Ost | 0,81 | 0,1448 | 0,0025 | 0,81 | 0,1448 | 0,0040 | 1,13 | 0,2027 | 0,0058 | 1,14 | 0,2027 | 0,0092 | 1,62 | 0,2317 | 0,0073 | 1,63 | 0,2317 | 0,0115 |
| A01- | Regau | Laakirchen West | 1,58 | 0,2838 | 0,0050 | 1,58 | 0,2838 | 0,0078 | 2,22 | 0,3974 | 0,0114 | 2,23 | 0,3974 | 0,0180 | 3,18 | 0,4541 | 0,0144 | 3,19 | 0,4541 | 0,0226 |
| A01- | Schörfling | Regau | 2,08 | 0,3730 | 0,0065 | 2,08 | 0,3730 | 0,0103 | 2,92 | 0,5221 | 0,0150 | 2,92 | 0,5221 | 0,0236 | 4,18 | 0,5967 | 0,0189 | 4,19 | 0,5967 | 0,0297 |
| A01- | Seewalchen | Schörfling | 0,32 | 0,0578 | 0,0010 | 0,32 | 0,0578 | 0,0016 | 0,45 | 0,0809 | 0,0023 | 0,45 | 0,0809 | 0,0037 | 0,65 | 0,0925 | 0,0029 | 0,65 | 0,0925 | 0,0046 |
| A01- | St. Georgen | Seewalchen | 1,88 | 0,3381 | 0,0059 | 1,89 | 0,3381 | 0,0093 | 2,64 | 0,4733 | 0,0136 | 2,65 | 0,4733 | 0,0214 | 3,79 | 0,5409 | 0,0172 | 3,80 | 0,5409 | 0,0270 |
| A01- | Oberwang | St. Georgen | 2,51 | 0,4508 | 0,0079 | 2,52 | 0,4508 | 0,0124 | 3,52 | 0,6311 | 0,0181 | 3,53 | 0,6311 | 0,0285 | 5,06 | 0,7213 | 0,0229 | 5,07 | 0,7213 | 0,0360 |
| A01- | Mondsee | Oberwang | 2,31 | 0,4149 | 0,0073 | 2,32 | 0,4149 | 0,0114 | 3,24 | 0,5809 | 0,0167 | 3,25 | 0,5809 | 0,0262 | 4,65 | 0,6639 | 0,0211 | 4,67 | 0,6639 | 0,0331 |
| A01- | Thalgau | Mondsee | 2,13 | 0,3825 | 0,0067 | 2,14 | 0,3825 | 0,0105 | 2,99 | 0,5355 | 0,0154 | 3,00 | 0,5355 | 0,0242 | 4,29 | 0,6120 | 0,0194 | 4,30 | 0,6120 | 0,0305 |
| A01- | Wallersee | Thalgau | 1,62 | 0,2915 | 0,0051 | 1,63 | 0,2915 | 0,0080 | 2,28 | 0,4081 | 0,0117 | 2,29 | 0,4081 | 0,0184 | 3,27 | 0,4664 | 0,0148 | 3,28 | 0,4664 | 0,0232 |
| A01- | Salzburg Nord | Wallersee | 1,57 | 0,2822 | 0,0049 | 1,58 | 0,2822 | 0,0078 | 2,21 | 0,3950 | 0,0114 | 2,21 | 0,3950 | 0,0178 | 3,16 | 0,4515 | 0,0143 | 3,17 | 0,4515 | 0,0225 |
| A01- | Salzburg Bergheim-West | Salzburg Nord | 0,35 | 0,0636 | 0,0011 | 0,36 | 0,0636 | 0,0017 | 0,50 | 0,0890 | 0,0026 | 0,50 | 0,0890 | 0,0040 | 0,71 | 0,1018 | 0,0032 | 0,72 | 0,1018 | 0,0051 |
| A01- | Messe | Salzburg Bergheim-West | 0,17 | 0,0304 | 0,0005 | 0,17 | 0,0304 | 0,0008 | 0,24 | 0,0426 | 0,0012 | 0,24 | 0,0426 | 0,0019 | 0,34 | 0,0487 | 0,0015 | 0,34 | 0,0487 | 0,0024 |
| A01- | Salzburg Mitte Freilassing | Messe | 0,23 | 0,0405 | 0,0007 | 0,23 | 0,0405 | 0,0011 | 0,32 | 0,0567 | 0,0016 | 0,32 | 0,0567 | 0,0026 | 0,45 | 0,0648 | 0,0021 | 0,46 | 0,0648 | 0,0032 |
| A01- | Kleßheim | Salzburg Mitte Freilassing | 0,28 | 0,0497 | 0,0009 | 0,28 | 0,0497 | 0,0014 | 0,39 | 0,0696 | 0,0020 | 0,39 | 0,0696 | 0,0031 | 0,56 | 0,0796 | 0,0025 | 0,56 | 0,0796 | 0,0040 |
| A01- | Siezenheim | Kleßheim | 0,38 | 0,0689 | 0,0012 | 0,38 | 0,0689 | 0,0019 | 0,54 | 0,0965 | 0,0028 | 0,54 | 0,0965 | 0,0044 | 0,77 | 0,1103 | 0,0035 | 0,78 | 0,1103 | 0,0055 |
| A01- | Flughafen | Siezenheim | 0,19 | 0,0346 | 0,0006 | 0,19 | 0,0346 | 0,0010 | 0,27 | 0,0485 | 0,0014 | 0,27 | 0,0485 | 0,0022 | 0,39 | 0,0554 | 0,0018 | 0,39 | 0,0554 | 0,0028 |
| A01- | Wals Salzburg West | Flughafen | 0,24 | 0,0424 | 0,0007 | 0,24 | 0,0424 | 0,0012 | 0,33 | 0,0593 | 0,0017 | 0,33 | 0,0593 | 0,0027 | 0,48 | 0,0678 | 0,0021 | 0,48 | 0,0678 | 0,0034 |
| A01- | KN Salzburg | Wals Salzburg West | 0,35 | 0,0634 | 0,0011 | 0,35 | 0,0634 | 0,0017 | 0,50 | 0,0888 | 0,0026 | 0,50 | 0,0888 | 0,0040 | 0,71 | 0,1014 | 0,0032 | 0,71 | 0,1014 | 0,0051 |
| A01- | Staatsgrenze Walsberg | KN Salzburg | 0,60 | 0,1077 | 0,0019 | 0,60 | 0,1077 | 0,0030 | 0,84 | 0,1508 | 0,0043 | 0,84 | 0,1508 | 0,0068 | 1,21 | 0,1724 | 0,0055 | 1,21 | 0,1724 | 0,0086 |
| A02- | KN Vösendorf | KN Wien Inzersdorf | 0,75 | 0,1348 | 0,0024 | 0,75 | 0,1348 | 0,0037 | 1,05 | 0,1887 | 0,0054 | 1,06 | 0,1887 | 0,0085 | 1,51 | 0,2157 | 0,0068 | 1,52 | 0,2157 | 0,0108 |
| A02- | Mödling | KN Vösendorf | 0,51 | 0,0916 | 0,0016 | 0,51 | 0,0916 | 0,0025 | 0,72 | 0,1283 | 0,0037 | 0,72 | 0,1283 | 0,0058 | 1,03 | 0,1466 | 0,0047 | 1,03 | 0,1466 | 0,0073 |
| A02- | Wr. Neudorf | Mödling | 0,49 | 0,0874 | 0,0015 | 0,49 | 0,0874 | 0,0024 | 0,68 | 0,1224 | 0,0035 | 0,69 | 0,1224 | 0,0055 | 0,98 | 0,1399 | 0,0044 | 0,98 | 0,1399 | 0,0070 |
| A02- | Wr. Neudorf IZ/Süd | Wr. Neudorf | 0,54 | 0,0962 | 0,0017 | 0,54 | 0,0962 | 0,0026 | 0,75 | 0,1347 | 0,0039 | 0,75 | 0,1347 | 0,0061 | 1,08 | 0,1539 | 0,0049 | 1,08 | 0,1539 | 0,0077 |
| A02- | KN Guntramsdorf | Wr. Neudorf IZ/Süd | 0,78 | 0,1402 | 0,0025 | 0,78 | 0,1402 | 0,0039 | 1,10 | 0,1963 | 0,0056 | 1,10 | 0,1963 | 0,0089 | 1,57 | 0,2244 | 0,0071 | 1,58 | 0,2244 | 0,0112 |
| A02- | Traiskirchen | KN Guntramsdorf | 0,87 | 0,1562 | 0,0027 | 0,87 | 0,1562 | 0,0043 | 1,22 | 0,2186 | 0,0063 | 1,22 | 0,2186 | 0,0099 | 1,75 | 0,2499 | 0,0079 | 1,76 | 0,2499 | 0,0125 |
| A02- | Baden | Traiskirchen | 0,48 | 0,0869 | 0,0015 | 0,49 | 0,0869 | 0,0024 | 0,68 | 0,1217 | 0,0035 | 0,68 | 0,1217 | 0,0055 | 0,97 | 0,1391 | 0,0044 | 0,98 | 0,1391 | 0,0069 |
| A02- | Bad Vöslau | Baden | 0,80 | 0,1428 | 0,0025 | 0,80 | 0,1428 | 0,0039 | 1,12 | 0,1999 | 0,0057 | 1,12 | 0,1999 | 0,0090 | 1,60 | 0,2285 | 0,0072 | 1,61 | 0,2285 | 0,0114 |
| A02- | Kottingbrunn | Bad Vöslau | 0,57 | 0,1031 | 0,0018 | 0,58 | 0,1031 | 0,0028 | 0,81 | 0,1444 | 0,0042 | 0,81 | 0,1444 | 0,0065 | 1,16 | 0,1650 | 0,0052 | 1,16 | 0,1650 | 0,0082 |
| A02- | Leobersdorf | Kottingbrunn | 0,50 | 0,0905 | 0,0016 | 0,51 | 0,0905 | 0,0025 | 0,71 | 0,1267 | 0,0036 | 0,71 | 0,1267 | 0,0057 | 1,01 | 0,1448 | 0,0046 | 1,02 | 0,1448 | 0,0072 |
| A02- | Wöllersdorf | Leobersdorf | 2,01 | 0,3610 | 0,0063 | 2,02 | 0,3610 | 0,0099 | 2,82 | 0,5054 | 0,0145 | 2,83 | 0,5054 | 0,0228 | 4,05 | 0,5776 | 0,0183 | 4,06 | 0,5776 | 0,0288 |
| A02- | Wr. Neustadt West | Wöllersdorf | 1,31 | 0,2345 | 0,0041 | 1,31 | 0,2345 | 0,0064 | 1,83 | 0,3283 | 0,0094 | 1,84 | 0,3283 | 0,0148 | 2,63 | 0,3752 | 0,0119 | 2,64 | 0,3752 | 0,0187 |
| A02- | KN Wr. Neustadt | Wr. Neustadt West | 0,52 | 0,0939 | 0,0016 | 0,52 | 0,0939 | 0,0026 | 0,73 | 0,1314 | 0,0038 | 0,74 | 0,1314 | 0,0059 | 1,05 | 0,1502 | 0,0048 | 1,06 | 0,1502 | 0,0075 |
| A02- | KN Seebenstein | KN Wr. Neustadt | 2,37 | 0,4248 | 0,0074 | 2,37 | 0,4248 | 0,0117 | 3,32 | 0,5947 | 0,0171 | 3,33 | 0,5947 | 0,0269 | 4,76 | 0,6797 | 0,0216 | 4,78 | 0,6797 | 0,0339 |
| A02- | Grimmenstein | KN Seebenstein | 2,02 | 0,3624 | 0,0063 | 2,02 | 0,3624 | 0,0100 | 2,83 | 0,5073 | 0,0146 | 2,84 | 0,5073 | 0,0229 | 4,06 | 0,5798 | 0,0184 | 4,07 | 0,5798 | 0,0289 |
| A02- | Edlitz | Grimmenstein | 0,56 | 0,1003 | 0,0018 | 0,56 | 0,1003 | 0,0028 | 0,78 | 0,1404 | 0,0040 | 0,79 | 0,1404 | 0,0063 | 1,13 | 0,1605 | 0,0051 | 1,13 | 0,1605 | 0,0080 |
| A02- | Krumbach | Edlitz | 1,73 | 0,3098 | 0,0054 | 1,73 | 0,3098 | 0,0085 | 2,42 | 0,4337 | 0,0125 | 2,43 | 0,4337 | 0,0196 | 3,47 | 0,4957 | 0,0157 | 3,48 | 0,4957 | 0,0247 |
| A02- | Zöbern | Krumbach | 0,91 | 0,1635 | 0,0029 | 0,91 | 0,1635 | 0,0045 | 1,28 | 0,2289 | 0,0066 | 1,28 | 0,2289 | 0,0103 | 1,83 | 0,2616 | 0,0083 | 1,84 | 0,2616 | 0,0130 |
| A02- | Aspang | Zöbern | 0,12 | 0,0214 | 0,0004 | 0,12 | 0,0214 | 0,0006 | 0,17 | 0,0299 | 0,0009 | 0,17 | 0,0299 | 0,0014 | 0,24 | 0,0342 | 0,0011 | 0,24 | 0,0342 | 0,0017 |
| A02- | Schäftern | Aspang | 1,44 | 0,2588 | 0,0045 | 1,44 | 0,2588 | 0,0071 | 2,02 | 0,3623 | 0,0104 | 2,03 | 0,3623 | 0,0164 | 2,90 | 0,4140 | 0,0131 | 2,91 | 0,4140 | 0,0206 |
| A02- | Pinggau/Friedberg | Schäftern | 1,72 | 0,3091 | 0,0054 | 1,73 | 0,3091 | 0,0085 | 2,42 | 0,4327 | 0,0124 | 2,42 | 0,4327 | 0,0195 | 3,47 | 0,4945 | 0,0157 | 3,48 | 0,4945 | 0,0246 |
| A02- | Pinkafeld | Pinggau/Friedberg | 1,17 | 0,2094 | 0,0037 | 1,17 | 0,2094 | 0,0058 | 1,64 | 0,2931 | 0,0084 | 1,64 | 0,2931 | 0,0132 | 2,35 | 0,3350 | 0,0106 | 2,35 | 0,3350 | 0,0167 |
| A02- | Lafnitzal/Oberwart | Pinkafeld | 2,43 | 0,4364 | 0,0076 | 2,44 | 0,4364 | 0,0120 | 3,41 | 0,6110 | 0,0176 | 3,42 | 0,6110 | 0,0276 | 4,90 | 0,6983 | 0,0221 | 4,91 | 0,6983 | 0,0348 |
| A02- | Hartberg | Lafnitzal/Oberwart | 0,96 | 0,1723 | 0,0030 | 0,96 | 0,1723 | 0,0047 | 1,35 | 0,2412 | 0,0069 | 1,35 | 0,2412 | 0,0109 | 1,93 | 0,2756 | 0,0087 | 1,94 | 0,2756 | 0,0137 |
| A02- | Sebersdorf/Bad Waltersdorf | Hartberg | 2,43 | 0,4359 | 0,0076 | 2,43 | 0,4359 | 0,0120 | 3,41 | 0,6103 | 0,0175 | 3,42 | 0,6103 | 0,0276 | 4,89 | 0,6975 | 0,0221 | 4,90 | 0,6975 | 0,0348 |
| A02- | Ilz Fürstenfeld | Sebersdorf/Bad Waltersdorf | 2,72 | 0,4888 | 0,0086 | 2,73 | 0,4888 | 0,0134 | 3,82 | 0,6843 | 0,0197 | 3,83 | 0,6843 | 0,0309 | 5,48 | 0,7820 | 0,0248 | 5,50 | 0,7820 | 0,0390 |
| A02- | Sinabelkirchen | Ilz Fürstenfeld | 2,50 | 0,4493 | 0,0079 | 2,51 | 0,4493 | 0,0124 | 3,51 | 0,6290 | 0,0181 | 3,52 | 0,6290 | 0,0284 | 5,04 | 0,7189 | 0,0228 | 5,05 | 0,7189 | 0,0358 |
| A02- | Gleisdorf Süd | Sinabelkirchen | 1,65 | 0,2960 | 0,0052 | 1,65 | 0,2960 | 0,0081 | 2,31 | 0,4144 | 0,0119 | 2,32 | 0,4144 | 0,0187 | 3,32 | 0,4736 | 0,0150 | 3,33 | 0,4736 | 0,0236 |
| A02- | Gleisdorf West | Gleisdorf Süd | 0,72 | 0,1285 | 0,0022 | 0,72 | 0,1285 | 0,0035 | 1,00 | 0,1799 | 0,0052 | 1,01 | 0,1799 | 0,0081 | 1,44 | 0,2056 | 0,0065 | 1,44 | 0,2056 | 0,0102 |
| A02- | Laßnitzhöhe | Gleisdorf West | 1,88 | 0,3366 | 0,0059 | 1,88 | 0,3366 | 0,0093 | 2,63 | 0,4713 | 0,0135 | 2,64 | 0,4713 | 0,0213 | 3,78 | 0,5386 | 0,0171 | 3,79 | 0,5386 | 0,0268 |
| A02- | KN Graz Ost | Laßnitzhöhe | 2,35 | 0,4212 | 0,0074 | 2,35 | 0,4212 | 0,0116 | 3,29 | 0,5896 | 0,0170 | 3,30 | 0,5896 | 0,0266 | 4,72 | 0,6739 | 0,0214 | 4,74 | 0,6739 | 0,0336 |
| A02- | Graz Feldkirchen Flughafen | KN Graz Ost | 0,84 | 0,1515 | 0,0027 | 0,85 | 0,1515 | 0,0042 | 1,18 | 0,2121 | 0,0061 | 1,19 | 0,2121 | 0,0096 | 1,70 | 0,2424 | 0,0077 | 1,70 | 0,2424 | 0,0121 |
| A02- | KN Graz West | Graz Feldkirchen Flughafen | 0,57 | 0,1014 | 0,0018 | 0,57 | 0,1014 | 0,0028 | 0,79 | 0,1420 | 0,0041 | 0,80 | 0,1420 | 0,0064 | 1,14 | 0,1623 | 0,0051 | 1,14 | 0,1623 | 0,0081 |
| A02- | Unterpremstätten | KN Graz West | 0,68 | 0,1220 | 0,0021 | 0,68 | 0,1220 | 0,0034 | 0,95 | 0,1707 | 0,0049 | 0,96 | 0,1707 | 0,0077 | 1,37 | 0,1951 | 0,0062 | 1,37 | 0,1951 | 0,0097 |
| A02- | Lieboch | Unterpremstätten | 1,06 | 0,1894 | 0,0033 | 1,06 | 0,1894 | 0,0052 | 1,48 | 0,2652 | 0,0076 | 1,49 | 0,2652 | 0,0120 | 2,12 | 0,3030 | 0,0096 | 2,13 | 0,3030 | 0,0151 |
| A02- | Mooskirchen | Lieboch | 1,46 | 0,2612 | 0,0046 | 1,46 | 0,2612 | 0,0072 | 2,04 | 0,3656 | 0,0105 | 2,05 | 0,3656 | 0,0165 | 2,93 | 0,4179 | 0,0133 | 2,94 | 0,4179 | 0,0208 |
| A02- | Steinberg | Mooskirchen | 1,51 | 0,2703 | 0,0047 | 1,51 | 0,2703 | 0,0074 | 2,11 | 0,3784 | 0,0109 | 2,12 | 0,3784 | 0,0171 | 3,03 | 0,4324 | 0,0137 | 3,04 | 0,4324 | 0,0216 |
| A02- | Modriach | Steinberg | 3,76 | 0,6756 | 0,0118 | 3,77 | 0,6756 | 0,0186 | 5,28 | 0,9458 | 0,0272 | 5,30 | | | | | | | | |

| | | | | | | | | | | | | | | | | | | | | |
|------|----------------------------------|----------------------------------|------|--------|--------|------|--------|--------|------|--------|--------|------|--------|--------|------|--------|--------|------|--------|--------|
| A02- | Velden West | Velden Ost | 0,83 | 0,1493 | 0,0026 | 0,83 | 0,1493 | 0,0041 | 1,17 | 0,2090 | 0,0060 | 1,17 | 0,2090 | 0,0094 | 1,67 | 0,2389 | 0,0076 | 1,68 | 0,2389 | 0,0119 |
| A02- | Wernberg | Velden West | 1,38 | 0,2468 | 0,0043 | 1,38 | 0,2468 | 0,0068 | 1,93 | 0,3455 | 0,0099 | 1,93 | 0,3455 | 0,0156 | 2,77 | 0,3949 | 0,0125 | 2,78 | 0,3949 | 0,0197 |
| A02- | KN Villach | Wernberg | 0,73 | 0,1312 | 0,0023 | 0,73 | 0,1312 | 0,0036 | 1,03 | 0,1837 | 0,0053 | 1,03 | 0,1837 | 0,0083 | 1,47 | 0,2099 | 0,0067 | 1,48 | 0,2099 | 0,0105 |
| A02- | Villach Faaker See | KN Villach | 0,57 | 0,1020 | 0,0018 | 0,57 | 0,1020 | 0,0028 | 0,80 | 0,1428 | 0,0041 | 0,80 | 0,1428 | 0,0065 | 1,14 | 0,1632 | 0,0052 | 1,15 | 0,1632 | 0,0081 |
| A02- | Villach Warmbad | Villach Faaker See | 1,30 | 0,2330 | 0,0041 | 1,30 | 0,2330 | 0,0064 | 1,82 | 0,3262 | 0,0094 | 1,83 | 0,3262 | 0,0147 | 2,61 | 0,3728 | 0,0118 | 2,62 | 0,3728 | 0,0186 |
| A02- | Hermagor | Villach Warmbad | 2,35 | 0,4224 | 0,0074 | 2,36 | 0,4224 | 0,0116 | 3,30 | 0,5914 | 0,0170 | 3,31 | 0,5914 | 0,0267 | 4,74 | 0,6758 | 0,0214 | 4,75 | 0,6758 | 0,0337 |
| A02- | Arnoldstein | Hermagor | 0,56 | 0,1006 | 0,0018 | 0,56 | 0,1006 | 0,0028 | 0,79 | 0,1408 | 0,0040 | 0,79 | 0,1408 | 0,0064 | 1,13 | 0,1610 | 0,0051 | 1,13 | 0,1610 | 0,0080 |
| A02- | Staatsgrenze Arnoldstein | Arnoldstein | 0,86 | 0,1542 | 0,0027 | 0,86 | 0,1542 | 0,0042 | 1,21 | 0,2159 | 0,0062 | 1,21 | 0,2159 | 0,0098 | 1,73 | 0,2468 | 0,0078 | 1,73 | 0,2468 | 0,0123 |
| A03- | Münchendorf/Achau | KN Guntramsdorf | 0,22 | 0,0400 | 0,0007 | 0,22 | 0,0400 | 0,0011 | 0,31 | 0,0561 | 0,0016 | 0,31 | 0,0561 | 0,0025 | 0,45 | 0,0641 | 0,0020 | 0,45 | 0,0641 | 0,0032 |
| A03- | Ebreichsdorf Nord | Münchendorf/Achau | 0,94 | 0,1686 | 0,0029 | 0,94 | 0,1686 | 0,0046 | 1,32 | 0,2360 | 0,0068 | 1,32 | 0,2360 | 0,0107 | 1,89 | 0,2697 | 0,0086 | 1,90 | 0,2697 | 0,0134 |
| A03- | Ebreichsdorf West | Ebreichsdorf Nord | 0,77 | 0,1376 | 0,0024 | 0,77 | 0,1376 | 0,0038 | 1,08 | 0,1926 | 0,0055 | 1,08 | 0,1926 | 0,0087 | 1,54 | 0,2202 | 0,0070 | 1,55 | 0,2202 | 0,0110 |
| A03- | Pottendorf | Ebreichsdorf West | 1,01 | 0,1805 | 0,0032 | 1,01 | 0,1805 | 0,0050 | 1,41 | 0,2527 | 0,0073 | 1,42 | 0,2527 | 0,0114 | 2,02 | 0,2888 | 0,0092 | 2,03 | 0,2888 | 0,0144 |
| A03- | Hornstein | Pottendorf | 1,65 | 0,2964 | 0,0052 | 1,65 | 0,2964 | 0,0082 | 2,32 | 0,4150 | 0,0119 | 2,32 | 0,4150 | 0,0187 | 3,32 | 0,4742 | 0,0150 | 3,33 | 0,4742 | 0,0236 |
| A03- | Müllendorf | Hornstein | 1,08 | 0,1942 | 0,0034 | 1,08 | 0,1942 | 0,0053 | 1,52 | 0,2719 | 0,0078 | 1,52 | 0,2719 | 0,0123 | 2,18 | 0,3108 | 0,0099 | 2,18 | 0,3108 | 0,0155 |
| A03- | KN Eisenstadt | Müllendorf | 0,90 | 0,1624 | 0,0028 | 0,91 | 0,1624 | 0,0045 | 1,27 | 0,2273 | 0,0065 | 1,27 | 0,2273 | 0,0103 | 1,82 | 0,2598 | 0,0082 | 1,83 | 0,2598 | 0,0129 |
| A031 | Siegendorf | KN Eisenstadt | 0,71 | 0,1280 | 0,0022 | 0,71 | 0,1280 | 0,0035 | 1,00 | 0,1792 | 0,0052 | 1,00 | 0,1792 | 0,0081 | 1,44 | 0,2048 | 0,0065 | 1,44 | 0,2048 | 0,0102 |
| A041 | KN Wien Prater | Stadionbrücke | 0,13 | 0,0235 | 0,0004 | 0,13 | 0,0235 | 0,0006 | 0,18 | 0,0329 | 0,0009 | 0,18 | 0,0329 | 0,0015 | 0,26 | 0,0376 | 0,0012 | 0,26 | 0,0376 | 0,0019 |
| A04- | Wien Simmeringer Haide | KN Wien Prater | 0,90 | 0,1622 | 0,0028 | 0,91 | 0,1622 | 0,0045 | 1,27 | 0,2271 | 0,0065 | 1,27 | 0,2271 | 0,0103 | 1,82 | 0,2595 | 0,0082 | 1,82 | 0,2595 | 0,0129 |
| A04- | KN Schwechat | Wien Simmeringer Haide | 0,81 | 0,1456 | 0,0025 | 0,81 | 0,1456 | 0,0040 | 1,14 | 0,2038 | 0,0059 | 1,14 | 0,2038 | 0,0092 | 1,63 | 0,2330 | 0,0074 | 1,64 | 0,2330 | 0,0116 |
| A04- | Flughafen Wien Schwechat | KN Schwechat | 1,17 | 0,2103 | 0,0037 | 1,17 | 0,2103 | 0,0058 | 1,64 | 0,2944 | 0,0085 | 1,65 | 0,2944 | 0,0133 | 2,36 | 0,3365 | 0,0107 | 2,37 | 0,3365 | 0,0168 |
| A04- | Fischamend | Flughafen Wien Schwechat | 1,31 | 0,2355 | 0,0041 | 1,31 | 0,2355 | 0,0065 | 1,84 | 0,3297 | 0,0095 | 1,85 | 0,3297 | 0,0149 | 2,64 | 0,3768 | 0,0120 | 2,65 | 0,3768 | 0,0188 |
| A04- | Bruck/Leitha West | Fischamend | 2,88 | 0,5164 | 0,0090 | 2,88 | 0,5164 | 0,0142 | 4,04 | 0,7230 | 0,0208 | 4,05 | 0,7230 | 0,0327 | 5,79 | 0,8263 | 0,0262 | 5,81 | 0,8263 | 0,0412 |
| A04- | Bruck/Leitha Ost | Bruck/Leitha West | 0,96 | 0,1715 | 0,0030 | 0,96 | 0,1715 | 0,0047 | 1,34 | 0,2401 | 0,0069 | 1,34 | 0,2401 | 0,0108 | 1,92 | 0,2744 | 0,0087 | 1,93 | 0,2744 | 0,0137 |
| A04- | KN Bruckneudorf | Bruck/Leitha Ost | 0,60 | 0,1070 | 0,0019 | 0,60 | 0,1070 | 0,0029 | 0,84 | 0,1498 | 0,0043 | 0,84 | 0,1498 | 0,0068 | 1,20 | 0,1712 | 0,0054 | 1,20 | 0,1712 | 0,0085 |
| A04- | Parndorf | KN Bruckneudorf | 0,38 | 0,0689 | 0,0012 | 0,38 | 0,0689 | 0,0019 | 0,54 | 0,0964 | 0,0028 | 0,54 | 0,0964 | 0,0044 | 0,77 | 0,1102 | 0,0035 | 0,77 | 0,1102 | 0,0055 |
| A04- | Neusiedl | Parndorf | 0,74 | 0,1332 | 0,0023 | 0,74 | 0,1332 | 0,0037 | 1,04 | 0,1865 | 0,0054 | 1,04 | 0,1865 | 0,0084 | 1,49 | 0,2131 | 0,0068 | 1,50 | 0,2131 | 0,0106 |
| A04- | Neusiedl/Gewerbepark | Neusiedl | 0,17 | 0,0309 | 0,0005 | 0,17 | 0,0309 | 0,0008 | 0,24 | 0,0432 | 0,0012 | 0,24 | 0,0432 | 0,0020 | 0,35 | 0,0494 | 0,0016 | 0,35 | 0,0494 | 0,0025 |
| A04- | Weiden/Gols | Neusiedl/Gewerbepark | 1,54 | 0,2762 | 0,0048 | 1,54 | 0,2762 | 0,0076 | 2,16 | 0,3867 | 0,0111 | 2,17 | 0,3867 | 0,0175 | 3,10 | 0,4420 | 0,0140 | 3,11 | 0,4420 | 0,0220 |
| A04- | Mönchhof | Weiden/Gols | 1,12 | 0,2015 | 0,0035 | 1,12 | 0,2015 | 0,0055 | 1,58 | 0,2821 | 0,0081 | 1,58 | 0,2821 | 0,0127 | 2,26 | 0,3224 | 0,0102 | 2,27 | 0,3224 | 0,0161 |
| A04- | Nickelsdorf | Mönchhof | 1,76 | 0,3157 | 0,0055 | 1,76 | 0,3157 | 0,0087 | 2,47 | 0,4420 | 0,0127 | 2,48 | 0,4420 | 0,0200 | 3,54 | 0,5052 | 0,0160 | 3,55 | 0,5052 | 0,0252 |
| A04- | Staatsgrenze Nickelsdorf | Nickelsdorf | 0,31 | 0,0559 | 0,0010 | 0,31 | 0,0559 | 0,0015 | 0,44 | 0,0783 | 0,0023 | 0,44 | 0,0783 | 0,0035 | 0,63 | 0,0895 | 0,0028 | 0,63 | 0,0895 | 0,0045 |
| A05- | Wolkersdorf Süd | KN Eibesbrunn | 0,61 | 0,1088 | 0,0019 | 0,61 | 0,1088 | 0,0030 | 0,85 | 0,1524 | 0,0044 | 0,85 | 0,1524 | 0,0069 | 1,22 | 0,1741 | 0,0055 | 1,22 | 0,1741 | 0,0087 |
| A05- | Ulrichskirchen | Wolkersdorf Süd | 0,66 | 0,1177 | 0,0021 | 0,66 | 0,1177 | 0,0032 | 0,92 | 0,1648 | 0,0047 | 0,92 | 0,1648 | 0,0074 | 1,32 | 0,1884 | 0,0060 | 1,32 | 0,1884 | 0,0094 |
| A05- | Wolkersdorf Nord | Ulrichskirchen | 0,43 | 0,0769 | 0,0013 | 0,43 | 0,0769 | 0,0021 | 0,60 | 0,1077 | 0,0031 | 0,60 | 0,1077 | 0,0049 | 0,86 | 0,1231 | 0,0039 | 0,87 | 0,1231 | 0,0061 |
| A05- | Hochleithen | Wolkersdorf Nord | 0,77 | 0,1380 | 0,0024 | 0,77 | 0,1380 | 0,0038 | 1,08 | 0,1932 | 0,0056 | 1,08 | 0,1932 | 0,0087 | 1,55 | 0,2208 | 0,0070 | 1,55 | 0,2208 | 0,0110 |
| A05- | Gaweinstal Mitte | Hochleithen | 1,54 | 0,2761 | 0,0048 | 1,54 | 0,2761 | 0,0076 | 2,16 | 0,3865 | 0,0111 | 2,16 | 0,3865 | 0,0175 | 3,10 | 0,4417 | 0,0140 | 3,10 | 0,4417 | 0,0220 |
| A05- | Gaweinstal Nord | Gaweinstal Mitte | 0,41 | 0,0730 | 0,0013 | 0,41 | 0,0730 | 0,0020 | 0,57 | 0,1023 | 0,0029 | 0,57 | 0,1023 | 0,0046 | 0,82 | 0,1169 | 0,0037 | 0,82 | 0,1169 | 0,0058 |
| A05- | Mistelbach Süd | Gaweinstal Nord | 0,70 | 0,1261 | 0,0022 | 0,70 | 0,1261 | 0,0035 | 0,99 | 0,1765 | 0,0051 | 0,99 | 0,1765 | 0,0080 | 1,41 | 0,2017 | 0,0064 | 1,42 | 0,2017 | 0,0101 |
| A05- | Mistelbach Ost / Wilfersdorf | Mistelbach Süd | 1,18 | 0,2116 | 0,0037 | 1,18 | 0,2116 | 0,0058 | 1,65 | 0,2962 | 0,0085 | 1,66 | 0,2962 | 0,0134 | 2,37 | 0,3386 | 0,0107 | 2,38 | 0,3386 | 0,0169 |
| A05- | Poysdorf Süd | Mistelbach Ost / Wilfersdorf | 1,19 | 0,2137 | 0,0037 | 1,19 | 0,2137 | 0,0059 | 1,67 | 0,2992 | 0,0086 | 1,68 | 0,2992 | 0,0135 | 2,40 | 0,3419 | 0,0108 | 2,40 | 0,3419 | 0,0170 |
| A05- | Großkrut | Poysdorf Süd | 1,57 | 0,2818 | 0,0049 | 1,57 | 0,2818 | 0,0077 | 2,20 | 0,3945 | 0,0113 | 2,21 | 0,3945 | 0,0178 | 3,16 | 0,4509 | 0,0143 | 3,17 | 0,4509 | 0,0225 |
| A05- | Poysdorf Nord | Großkrut | 1,53 | 0,2741 | 0,0048 | 1,53 | 0,2741 | 0,0075 | 2,14 | 0,3838 | 0,0110 | 2,15 | 0,3838 | 0,0173 | 3,07 | 0,4386 | 0,0139 | 3,08 | 0,4386 | 0,0219 |
| A06- | Potzneusiedl | KN Bruckneudorf | 1,94 | 0,3472 | 0,0061 | 1,94 | 0,3472 | 0,0095 | 2,71 | 0,4861 | 0,0140 | 2,72 | 0,4861 | 0,0220 | 3,89 | 0,5556 | 0,0176 | 3,90 | 0,5556 | 0,0277 |
| A06- | Gattendorf | Potzneusiedl | 0,84 | 0,1507 | 0,0026 | 0,84 | 0,1507 | 0,0041 | 1,18 | 0,2110 | 0,0061 | 1,18 | 0,2110 | 0,0095 | 1,69 | 0,2412 | 0,0076 | 1,69 | 0,2412 | 0,0120 |
| A06- | Kittsee | Gattendorf | 1,40 | 0,2521 | 0,0044 | 1,41 | 0,2521 | 0,0069 | 1,97 | 0,3529 | 0,0101 | 1,98 | 0,3529 | 0,0159 | 2,83 | 0,4033 | 0,0128 | 2,83 | 0,4033 | 0,0201 |
| A06- | Staatsgrenze Kittsee | Kittsee | 0,71 | 0,1280 | 0,0022 | 0,71 | 0,1280 | 0,0035 | 1,00 | 0,1793 | 0,0052 | 1,00 | 0,1793 | 0,0081 | 1,44 | 0,2049 | 0,0065 | 1,44 | 0,2049 | 0,0102 |
| A07- | Linz Franzosenhausweg | KN Linz | 0,50 | 0,0903 | 0,0016 | 0,50 | 0,0903 | 0,0025 | 0,71 | 0,1264 | 0,0036 | 0,71 | 0,1264 | 0,0057 | 1,01 | 0,1445 | 0,0046 | 1,02 | 0,1445 | 0,0072 |
| A07- | Linz Salzburger Straße Neue Welt | Linz Franzosenhausweg | 0,44 | 0,0788 | 0,0014 | 0,44 | 0,0788 | 0,0022 | 0,62 | 0,1104 | 0,0032 | 0,62 | 0,1104 | 0,0050 | 0,88 | 0,1261 | 0,0040 | 0,89 | 0,1261 | 0,0063 |
| A07- | Muldenstraße Bindermichl | Linz Salzburger Straße Neue Welt | 0,30 | 0,0547 | 0,0010 | 0,31 | 0,0547 | 0,0015 | 0,43 | 0,0766 | 0,0022 | 0,43 | 0,0766 | 0,0035 | 0,61 | 0,0876 | 0,0028 | 0,62 | 0,0876 | 0,0044 |
| A07- | Leonding Linz Zentrum | Muldenstraße Bindermichl | 0,15 | 0,0266 | 0,0005 | 0,15 | 0,0266 | 0,0007 | 0,21 | 0,0372 | 0,0011 | 0,21 | 0,0372 | 0,0017 | 0,30 | 0,0425 | 0,0013 | 0,30 | 0,0425 | 0,0021 |
| A07- | Linz Wiener Straße | Leonding Linz Zentrum | 0,21 | 0,0374 | 0,0007 | 0,21 | 0,0374 | 0,0010 | 0,29 | 0,0523 | 0,0015 | 0,29 | 0,0523 | 0,0024 | 0,42 | 0,0598 | 0,0019 | 0,42 | 0,0598 | 0,0030 |
| A07- | Linz VOEST | Linz Wiener Straße | 0,19 | 0,0347 | 0,0006 | 0,19 | 0,0347 | 0,0010 | 0,27 | 0,0486 | 0,0014 | 0,27 | 0,0486 | 0,0022 | 0,39 | 0,0556 | 0,0018 | 0,39 | 0,0556 | 0,0028 |
| A07- | Linz Industriezeile | Linz VOEST | 0,15 | 0,0272 | 0,0005 | 0,15 | 0,0272 | 0,0007 | 0,21 | 0,0381 | 0,0011 | 0,21 | 0,0381 | 0,0017 | 0,31 | 0,0436 | 0,0014 | 0,31 | 0,0436 | 0,0022 |
| A07- | Linz Prinz Eugenstraße | Linz Industriezeile | 0,24 | 0,0432 | 0,0008 | 0,24 | 0,0432 | 0,0012 | 0,34 | 0,0605 | 0,0017 | 0,34 | 0,0605 | 0,0027 | 0,49 | 0,0692 | 0,0022 | 0,49 | 0,0692 | 0,0034 |
| A07- | Linz Hafenstraße | Linz Prinz Eugenstraße | 0,45 | 0,0809 | 0,0014 | 0,45 | 0,0809 | 0,0022 | 0,63 | 0,1133 | 0,0033 | 0,63 | 0,1133 | 0,0051 | 0,91 | 0,1295 | 0,0041 | 0,91 | 0,1295 | 0,0065 |
| A07- | Linz Urfahr | Linz Hafenstraße | 0,18 | 0,0318 | 0,0006 | 0,18 | 0,0318 | 0,0009 | 0,25 | 0,0445 | 0,0013 | 0,25 | 0,0445 | 0,0020 | 0,36 | 0,0509 | 0,0016 | 0,36 | 0,0509 | 0,0025 |
| A07- | Linz Dornach | Linz Urfahr | 0,43 | 0,0770 | 0,0013 | 0,43 | 0,0770 | | | | | | | | | | | | | |

| | | | | | | | | | | | | | | | | | | | | |
|------|---|--------------------------------------|-------|--------|--------|-------|--------|--------|-------|--------|--------|-------|--------|--------|-------|--------|--------|-------|--------|--------|
| A08- | Staatsgrenze Suben | Schärding Suben | 0,50 | 0,0893 | 0,0016 | 0,50 | 0,0893 | 0,0025 | 0,70 | 0,1250 | 0,0036 | 0,70 | 0,1250 | 0,0056 | 1,00 | 0,1428 | 0,0045 | 1,00 | 0,1428 | 0,0071 |
| A09- | Ried im Traunkreis | KN Voralpenkreuz | 1,23 | 0,2200 | 0,0039 | 1,23 | 0,2200 | 0,0061 | 1,72 | 0,3081 | 0,0089 | 1,73 | 0,3081 | 0,0139 | 2,47 | 0,3521 | 0,0112 | 2,47 | 0,3521 | 0,0175 |
| A09- | Inzersdorf Kirchdorf | Ried im Traunkreis | 2,30 | 0,4128 | 0,0072 | 2,30 | 0,4128 | 0,0114 | 3,23 | 0,5779 | 0,0166 | 3,24 | 0,5779 | 0,0261 | 4,63 | 0,6604 | 0,0209 | 4,64 | 0,6604 | 0,0329 |
| A09- | Klaus | Inzersdorf Kirchdorf | 2,80 | 0,5028 | 0,0088 | 2,81 | 0,5028 | 0,0138 | 3,93 | 0,7039 | 0,0202 | 3,94 | 0,7039 | 0,0318 | 5,64 | 0,8045 | 0,0255 | 5,65 | 0,8045 | 0,0401 |
| A09- | St. Pankratz | Klaus | 1,78 | 0,3196 | 0,0056 | 1,78 | 0,3196 | 0,0088 | 2,50 | 0,4474 | 0,0129 | 2,51 | 0,4474 | 0,0202 | 3,58 | 0,5114 | 0,0162 | 3,59 | 0,5114 | 0,0255 |
| A09- | Roßleiten Windischgarsten | St. Pankratz | 2,48 | 0,4459 | 0,0078 | 2,49 | 0,4459 | 0,0123 | 3,49 | 0,6243 | 0,0179 | 3,50 | 0,6243 | 0,0282 | 5,00 | 0,7135 | 0,0226 | 5,01 | 0,7135 | 0,0356 |
| A09- | Gleinkerau | Roßleiten Windischgarsten | 1,17 | 0,2096 | 0,0037 | 1,17 | 0,2096 | 0,0058 | 1,64 | 0,2934 | 0,0084 | 1,64 | 0,2934 | 0,0133 | 2,35 | 0,3354 | 0,0106 | 2,36 | 0,3354 | 0,0167 |
| A09- | Spital am Pyhrn | Gleinkerau | 0,88 | 0,1580 | 0,0028 | 0,88 | 0,1580 | 0,0043 | 1,24 | 0,2212 | 0,0064 | 1,24 | 0,2212 | 0,0100 | 1,77 | 0,2528 | 0,0080 | 1,78 | 0,2528 | 0,0126 |
| A09- | Ardning / Admont | Spital am Pyhrn | 4,53 | 0,4022 | 0,0070 | 4,54 | 0,4022 | 0,0111 | 6,35 | 0,5631 | 0,0162 | 6,36 | 0,5631 | 0,0254 | 9,33 | 0,6436 | 0,0204 | 9,34 | 0,6436 | 0,0321 |
| A09- | Liezen | Ardning / Admont | 0,51 | 0,0917 | 0,0016 | 0,51 | 0,0917 | 0,0025 | 0,72 | 0,1284 | 0,0037 | 0,72 | 0,1284 | 0,0058 | 1,03 | 0,1467 | 0,0047 | 1,03 | 0,1467 | 0,0073 |
| A09- | Rottenmann | Liezen | 1,07 | 0,1916 | 0,0034 | 1,07 | 0,1916 | 0,0053 | 1,50 | 0,2682 | 0,0077 | 1,50 | 0,2682 | 0,0121 | 2,15 | 0,3065 | 0,0097 | 2,15 | 0,3065 | 0,0153 |
| A09- | Trieben | Rottenmann | 2,66 | 0,4776 | 0,0084 | 2,67 | 0,4776 | 0,0131 | 3,73 | 0,6686 | 0,0192 | 3,74 | 0,6686 | 0,0302 | 5,36 | 0,7641 | 0,0242 | 5,37 | 0,7641 | 0,0381 |
| A09- | Treglwang | Trieben | 2,16 | 0,3883 | 0,0068 | 2,17 | 0,3883 | 0,0107 | 3,04 | 0,5436 | 0,0156 | 3,04 | 0,5436 | 0,0246 | 4,36 | 0,6212 | 0,0197 | 4,37 | 0,6212 | 0,0310 |
| A09- | Kalwang | Treglwang | 2,91 | 0,5218 | 0,0091 | 2,91 | 0,5218 | 0,0143 | 4,08 | 0,7305 | 0,0210 | 4,09 | 0,7305 | 0,0330 | 5,85 | 0,8349 | 0,0265 | 5,87 | 0,8349 | 0,0416 |
| A09- | Mautern | Kalwang | 1,35 | 0,2430 | 0,0043 | 1,36 | 0,2430 | 0,0067 | 1,90 | 0,3401 | 0,0098 | 1,90 | 0,3401 | 0,0154 | 2,73 | 0,3887 | 0,0123 | 2,73 | 0,3887 | 0,0194 |
| A09- | Kammern | Mautern | 1,52 | 0,2733 | 0,0048 | 1,53 | 0,2733 | 0,0075 | 2,14 | 0,3826 | 0,0110 | 2,14 | 0,3826 | 0,0173 | 3,07 | 0,4373 | 0,0139 | 3,07 | 0,4373 | 0,0218 |
| A09- | Traboch | Kammern | 1,59 | 0,2858 | 0,0050 | 1,60 | 0,2858 | 0,0079 | 2,23 | 0,4001 | 0,0115 | 2,24 | 0,4001 | 0,0181 | 3,21 | 0,4572 | 0,0145 | 3,21 | 0,4572 | 0,0228 |
| A09- | Terminal St. Michael | Traboch | 0,31 | 0,0561 | 0,0010 | 0,31 | 0,0561 | 0,0015 | 0,44 | 0,0786 | 0,0023 | 0,44 | 0,0786 | 0,0035 | 0,63 | 0,0898 | 0,0028 | 0,63 | 0,0898 | 0,0045 |
| A09- | KN St. Michael | Terminal St. Michael | 0,59 | 0,1052 | 0,0018 | 0,59 | 0,1052 | 0,0029 | 0,82 | 0,1473 | 0,0042 | 0,82 | 0,1473 | 0,0067 | 1,18 | 0,1683 | 0,0053 | 1,18 | 0,1683 | 0,0084 |
| A09- | Übelbach | KN St. Michael | 11,04 | 0,9797 | 0,0171 | 11,05 | 0,9797 | 0,0269 | 15,48 | 1,3716 | 0,0394 | 15,50 | 1,3716 | 0,0620 | 22,72 | 1,5676 | 0,0497 | 22,74 | 1,5676 | 0,0781 |
| A09- | KN Peggau Deutschefstritz | Übelbach | 1,81 | 0,3240 | 0,0057 | 1,81 | 0,3240 | 0,0089 | 2,53 | 0,4537 | 0,0130 | 2,54 | 0,4537 | 0,0205 | 3,63 | 0,5185 | 0,0164 | 3,64 | 0,5185 | 0,0258 |
| A09- | Gratkorn Nord | KN Peggau Deutschefstritz | 0,86 | 0,1535 | 0,0027 | 0,86 | 0,1535 | 0,0042 | 1,20 | 0,2149 | 0,0062 | 1,20 | 0,2149 | 0,0097 | 1,72 | 0,2456 | 0,0078 | 1,73 | 0,2456 | 0,0122 |
| A09- | Gratkorn Süd | Gratkorn Nord | 0,94 | 0,1686 | 0,0030 | 0,94 | 0,1686 | 0,0046 | 1,32 | 0,2360 | 0,0068 | 1,32 | 0,2360 | 0,0107 | 1,89 | 0,2698 | 0,0086 | 1,90 | 0,2698 | 0,0134 |
| A09- | Graz Nord | Gratkorn Süd | 0,21 | 0,0374 | 0,0007 | 0,21 | 0,0374 | 0,0010 | 0,29 | 0,0523 | 0,0015 | 0,29 | 0,0523 | 0,0024 | 0,42 | 0,0598 | 0,0019 | 0,42 | 0,0598 | 0,0030 |
| A09- | Graz Webling | Graz Nord | 2,38 | 0,4274 | 0,0075 | 2,39 | 0,4274 | 0,0118 | 3,34 | 0,5983 | 0,0172 | 3,35 | 0,5983 | 0,0270 | 4,79 | 0,6838 | 0,0217 | 4,81 | 0,6838 | 0,0341 |
| A09- | Seiersberg | Graz Webling | 0,63 | 0,1136 | 0,0020 | 0,63 | 0,1136 | 0,0031 | 0,89 | 0,1590 | 0,0046 | 0,89 | 0,1590 | 0,0072 | 1,27 | 0,1818 | 0,0058 | 1,28 | 0,1818 | 0,0091 |
| A09- | KN Graz West | Seiersberg | 0,31 | 0,0556 | 0,0010 | 0,31 | 0,0556 | 0,0015 | 0,43 | 0,0778 | 0,0022 | 0,44 | 0,0778 | 0,0035 | 0,62 | 0,0890 | 0,0028 | 0,63 | 0,0890 | 0,0044 |
| A09- | Schwarzlsee | KN Graz West | 0,31 | 0,0548 | 0,0010 | 0,31 | 0,0548 | 0,0015 | 0,43 | 0,0767 | 0,0022 | 0,43 | 0,0767 | 0,0035 | 0,61 | 0,0877 | 0,0028 | 0,62 | 0,0877 | 0,0044 |
| A09- | Schachenwald / IBC Businesscenter | Schwarzlsee | 0,34 | 0,0613 | 0,0011 | 0,34 | 0,0613 | 0,0017 | 0,48 | 0,0858 | 0,0025 | 0,48 | 0,0858 | 0,0039 | 0,69 | 0,0980 | 0,0031 | 0,69 | 0,0980 | 0,0049 |
| A09- | Kalsdorf | Schachenwald / IBC Businesscenter | 0,35 | 0,0623 | 0,0011 | 0,35 | 0,0623 | 0,0017 | 0,49 | 0,0872 | 0,0025 | 0,49 | 0,0872 | 0,0039 | 0,70 | 0,0997 | 0,0032 | 0,70 | 0,0997 | 0,0050 |
| A09- | Werndorf Terminal | Kalsdorf | 0,87 | 0,1560 | 0,0027 | 0,87 | 0,1560 | 0,0043 | 1,22 | 0,2184 | 0,0063 | 1,22 | 0,2184 | 0,0099 | 1,75 | 0,2496 | 0,0079 | 1,75 | 0,2496 | 0,0124 |
| A09- | Wildon | Werndorf Terminal | 0,97 | 0,1744 | 0,0031 | 0,97 | 0,1744 | 0,0048 | 1,36 | 0,2441 | 0,0070 | 1,37 | 0,2441 | 0,0110 | 1,96 | 0,2790 | 0,0088 | 1,96 | 0,2790 | 0,0139 |
| A09- | Hengsberg | Wildon | 0,47 | 0,0851 | 0,0015 | 0,48 | 0,0851 | 0,0023 | 0,67 | 0,1192 | 0,0034 | 0,67 | 0,1192 | 0,0054 | 0,95 | 0,1362 | 0,0043 | 0,96 | 0,1362 | 0,0068 |
| A09- | Lebring | Hengsberg | 0,84 | 0,1508 | 0,0026 | 0,84 | 0,1508 | 0,0041 | 1,18 | 0,2111 | 0,0061 | 1,18 | 0,2111 | 0,0095 | 1,69 | 0,2413 | 0,0077 | 1,70 | 0,2413 | 0,0120 |
| A09- | Leibnitz | Lebring | 1,45 | 0,2610 | 0,0046 | 1,46 | 0,2610 | 0,0072 | 2,04 | 0,3655 | 0,0105 | 2,05 | 0,3655 | 0,0165 | 2,93 | 0,4177 | 0,0132 | 2,94 | 0,4177 | 0,0208 |
| A09- | Vogau Straß | Leibnitz | 1,78 | 0,3192 | 0,0056 | 1,78 | 0,3192 | 0,0088 | 2,50 | 0,4469 | 0,0128 | 2,50 | 0,4469 | 0,0202 | 3,58 | 0,5108 | 0,0162 | 3,59 | 0,5108 | 0,0255 |
| A09- | Gersdorf | Vogau Straß | 0,86 | 0,1548 | 0,0027 | 0,86 | 0,1548 | 0,0043 | 1,21 | 0,2168 | 0,0062 | 1,21 | 0,2168 | 0,0098 | 1,74 | 0,2477 | 0,0079 | 1,74 | 0,2477 | 0,0123 |
| A09- | Spielfeld | Gersdorf | 0,45 | 0,0816 | 0,0014 | 0,46 | 0,0816 | 0,0022 | 0,64 | 0,1142 | 0,0033 | 0,64 | 0,1142 | 0,0052 | 0,92 | 0,1306 | 0,0041 | 0,92 | 0,1306 | 0,0065 |
| A09- | Staatsgrenze Spielfeld | Spielfeld | 0,41 | 0,0744 | 0,0013 | 0,42 | 0,0744 | 0,0020 | 0,58 | 0,1042 | 0,0030 | 0,58 | 0,1042 | 0,0047 | 0,83 | 0,1190 | 0,0038 | 0,84 | 0,1190 | 0,0059 |
| A10- | Salzburg Süd / Anif | KN Salzburg | 1,68 | 0,3010 | 0,0053 | 1,68 | 0,3010 | 0,0083 | 2,35 | 0,4213 | 0,0121 | 2,36 | 0,4213 | 0,0190 | 3,38 | 0,4815 | 0,0153 | 3,38 | 0,4815 | 0,0240 |
| A10- | Puch Urstein | Salzburg Süd / Anif | 0,57 | 0,1021 | 0,0018 | 0,57 | 0,1021 | 0,0028 | 0,80 | 0,1430 | 0,0041 | 0,80 | 0,1430 | 0,0065 | 1,15 | 0,1634 | 0,0052 | 1,15 | 0,1634 | 0,0081 |
| A10- | Hallein | Puch Urstein | 1,17 | 0,2108 | 0,0037 | 1,18 | 0,2108 | 0,0058 | 1,65 | 0,2952 | 0,0085 | 1,65 | 0,2952 | 0,0133 | 2,36 | 0,3373 | 0,0107 | 2,37 | 0,3373 | 0,0168 |
| A10- | Kuchl | Hallein | 1,30 | 0,2342 | 0,0041 | 1,31 | 0,2342 | 0,0064 | 1,83 | 0,3278 | 0,0094 | 1,84 | 0,3278 | 0,0148 | 2,63 | 0,3747 | 0,0119 | 2,63 | 0,3747 | 0,0187 |
| A10- | Golling / Abtenau | Kuchl | 1,31 | 0,2354 | 0,0041 | 1,31 | 0,2354 | 0,0065 | 1,84 | 0,3296 | 0,0095 | 1,85 | 0,3296 | 0,0149 | 2,64 | 0,3766 | 0,0119 | 2,65 | 0,3766 | 0,0188 |
| A10- | Paß Lueg | Golling / Abtenau | 1,37 | 0,2456 | 0,0043 | 1,37 | 0,2456 | 0,0068 | 1,92 | 0,3439 | 0,0099 | 1,93 | 0,3439 | 0,0155 | 2,76 | 0,3930 | 0,0125 | 2,76 | 0,3930 | 0,0196 |
| A10- | Werfen | Paß Lueg | 1,95 | 0,3499 | 0,0061 | 1,95 | 0,3499 | 0,0096 | 2,74 | 0,4898 | 0,0141 | 2,74 | 0,4898 | 0,0221 | 3,92 | 0,5598 | 0,0178 | 3,93 | 0,5598 | 0,0279 |
| A10- | Pfarrwerfen / Werfen | Werfen | 0,25 | 0,0456 | 0,0008 | 0,25 | 0,0456 | 0,0013 | 0,36 | 0,0638 | 0,0018 | 0,36 | 0,0638 | 0,0029 | 0,51 | 0,0730 | 0,0023 | 0,51 | 0,0730 | 0,0036 |
| A10- | KN Pongau | Pfarrwerfen / Werfen | 0,55 | 0,0990 | 0,0017 | 0,55 | 0,0990 | 0,0027 | 0,77 | 0,1385 | 0,0040 | 0,78 | 0,1385 | 0,0063 | 1,11 | 0,1583 | 0,0050 | 1,11 | 0,1583 | 0,0079 |
| A101 | Bischofshofen Mühlbach a. Hochkönig | KN Pongau | 0,82 | 0,1472 | 0,0026 | 0,82 | 0,1472 | 0,0040 | 1,15 | 0,2061 | 0,0059 | 1,15 | 0,2061 | 0,0093 | 1,65 | 0,2355 | 0,0075 | 1,66 | 0,2355 | 0,0117 |
| A10- | Lammertal Hüttal | KN Pongau | 2,24 | 0,4025 | 0,0070 | 2,25 | 0,4025 | 0,0111 | 3,15 | 0,5635 | 0,0162 | 3,16 | 0,5635 | 0,0255 | 4,51 | 0,6440 | 0,0204 | 4,53 | 0,6440 | 0,0321 |
| A10- | F. Verbindung GH Eben | Lammertal Hüttal | 0,58 | 0,1036 | 0,0018 | 0,58 | 0,1036 | 0,0028 | 0,81 | 0,1450 | 0,0042 | 0,81 | 0,1450 | 0,0066 | 1,16 | 0,1658 | 0,0053 | 1,17 | 0,1658 | 0,008 |

| | | | | | | | | | | | | | | | | | | | | |
|------|-------------------------------------|-------------------------------------|------|----------|--------|------|--------|--------|------|--------|--------|------|--------|--------|-------|--------|--------|-------|--------|--------|
| A12- | Kufstein Nord | Staatsgrenze Kufstein | 0,36 | 0,0000 | 0,0000 | 0,36 | 0,0000 | 0,0000 | 0,51 | 0,0000 | 0,0000 | 0,51 | 0,0000 | 0,0000 | 0,76 | 0,0000 | 0,0000 | 0,76 | 0,0000 | 0,0000 |
| A12- | Kufstein Süd | Kufstein Nord | 0,93 | 0,0000 | 0,0000 | 0,93 | 0,0000 | 0,0000 | 1,31 | 0,0000 | 0,0000 | 1,31 | 0,0000 | 0,0000 | 1,96 | 0,0000 | 0,0000 | 1,96 | 0,0000 | 0,0000 |
| A12- | Kirchbichl Langkampfen | Kufstein Süd | 1,27 | 0,0000 | 0,0000 | 1,27 | 0,0000 | 0,0000 | 1,78 | 0,0000 | 0,0000 | 1,78 | 0,0000 | 0,0000 | 2,68 | 0,0000 | 0,0000 | 2,68 | 0,0000 | 0,0000 |
| A12- | Wörgl Ost St.Johann i. T. Brixental | Kirchbichl Langkampfen | 1,25 | 0,0000 | 0,0000 | 1,25 | 0,0000 | 0,0000 | 1,75 | 0,0000 | 0,0000 | 1,75 | 0,0000 | 0,0000 | 2,62 | 0,0000 | 0,0000 | 2,62 | 0,0000 | 0,0000 |
| A12- | Wörgl West | Wörgl Ost St.Johann i. T. Brixental | 0,66 | 0,0000 | 0,0000 | 0,66 | 0,0000 | 0,0000 | 0,92 | 0,0000 | 0,0000 | 0,92 | 0,0000 | 0,0000 | 1,38 | 0,0000 | 0,0000 | 1,38 | 0,0000 | 0,0000 |
| A12- | Kramsach Rattenberg Brixlegg | Wörgl West | 2,80 | 0,0000 | 0,0000 | 2,80 | 0,0000 | 0,0000 | 3,92 | 0,0000 | 0,0000 | 3,92 | 0,0000 | 0,0000 | 5,88 | 0,0000 | 0,0000 | 5,88 | 0,0000 | 0,0000 |
| A12- | Wiesing Achensee Zillertal | Kramsach Rattenberg Brixlegg | 1,72 | 0,0000 | 0,0000 | 1,72 | 0,0000 | 0,0000 | 2,40 | 0,0000 | 0,0000 | 2,40 | 0,0000 | 0,0000 | 3,61 | 0,0000 | 0,0000 | 3,61 | 0,0000 | 0,0000 |
| A12- | Jenbach | Wiesing Achensee Zillertal | 0,68 | 0,0000 | 0,0000 | 0,68 | 0,0000 | 0,0000 | 0,95 | 0,0000 | 0,0000 | 0,95 | 0,0000 | 0,0000 | 1,43 | 0,0000 | 0,0000 | 1,43 | 0,0000 | 0,0000 |
| A12- | Schwaz | Jenbach | 1,50 | 0,0000 | 0,0000 | 1,50 | 0,0000 | 0,0000 | 2,10 | 0,0000 | 0,0000 | 2,10 | 0,0000 | 0,0000 | 3,15 | 0,0000 | 0,0000 | 3,15 | 0,0000 | 0,0000 |
| A12- | Vomp | Schwaz | 0,86 | 0,0000 | 0,0000 | 0,86 | 0,0000 | 0,0000 | 1,20 | 0,0000 | 0,0000 | 1,20 | 0,0000 | 0,0000 | 1,80 | 0,0000 | 0,0000 | 1,80 | 0,0000 | 0,0000 |
| A12- | Wattens | Vomp | 1,77 | 0,0000 | 0,0000 | 1,77 | 0,0000 | 0,0000 | 2,47 | 0,0000 | 0,0000 | 2,47 | 0,0000 | 0,0000 | 3,71 | 0,0000 | 0,0000 | 3,71 | 0,0000 | 0,0000 |
| A12- | Hall/Tirol Mitte | Wattens | 1,57 | 0,0000 | 0,0000 | 1,57 | 0,0000 | 0,0000 | 2,19 | 0,0000 | 0,0000 | 2,19 | 0,0000 | 0,0000 | 3,29 | 0,0000 | 0,0000 | 3,29 | 0,0000 | 0,0000 |
| A12- | Hall/Tirol West | Hall/Tirol Mitte | 0,63 | 0,0000 | 0,0000 | 0,63 | 0,0000 | 0,0000 | 0,88 | 0,0000 | 0,0000 | 0,88 | 0,0000 | 0,0000 | 1,32 | 0,0000 | 0,0000 | 1,32 | 0,0000 | 0,0000 |
| A12- | A12 Innsbruck Ost | Hall/Tirol West | 0,70 | 0,0000 | 0,0000 | 0,70 | 0,0000 | 0,0000 | 0,97 | 0,0000 | 0,0000 | 0,97 | 0,0000 | 0,0000 | 1,46 | 0,0000 | 0,0000 | 1,46 | 0,0000 | 0,0000 |
| A12- | Innsbruck Mitte | A12 Innsbruck Ost | 0,48 | 0,0226 | 0,0004 | 0,48 | 0,0226 | 0,0006 | 0,67 | 0,0317 | 0,0009 | 0,67 | 0,0317 | 0,0014 | 0,99 | 0,0362 | 0,0011 | 0,99 | 0,0362 | 0,0018 |
| A12- | A12 Innsbruck West | Innsbruck Mitte | 0,71 | 0,1280 | 0,0022 | 0,71 | 0,1280 | 0,0035 | 1,00 | 0,1792 | 0,0052 | 1,00 | 0,1792 | 0,0081 | 1,44 | 0,2048 | 0,0065 | 1,44 | 0,2048 | 0,0102 |
| A12- | Innsbruck Kranebitten | A12 Innsbruck West | 0,93 | 0,1678 | 0,0029 | 0,94 | 0,1678 | 0,0046 | 1,31 | 0,2349 | 0,0068 | 1,32 | 0,2349 | 0,0106 | 1,88 | 0,2684 | 0,0085 | 1,89 | 0,2684 | 0,0134 |
| A12- | Zirl Ost Garmisch Seefeld | Innsbruck Kranebitten | 1,08 | 0,1947 | 0,0034 | 1,09 | 0,1947 | 0,0054 | 1,52 | 0,2726 | 0,0078 | 1,53 | 0,2726 | 0,0123 | 2,18 | 0,3115 | 0,0099 | 2,19 | 0,3115 | 0,0155 |
| A12- | Zirl West | Zirl Ost Garmisch Seefeld | 0,68 | 0,1218 | 0,0021 | 0,68 | 0,1218 | 0,0033 | 0,95 | 0,1705 | 0,0049 | 0,95 | 0,1705 | 0,0077 | 1,37 | 0,1949 | 0,0062 | 1,37 | 0,1949 | 0,0097 |
| A12- | Petttau | Zirl West | 1,22 | 0,2181 | 0,0038 | 1,22 | 0,2181 | 0,0060 | 1,71 | 0,3054 | 0,0088 | 1,71 | 0,3054 | 0,0138 | 2,45 | 0,3490 | 0,0111 | 2,45 | 0,3490 | 0,0174 |
| A12- | Telfs Ost | Petttau | 1,23 | 0,2205 | 0,0039 | 1,23 | 0,2205 | 0,0061 | 1,72 | 0,3087 | 0,0089 | 1,73 | 0,3087 | 0,0139 | 2,47 | 0,3528 | 0,0112 | 2,48 | 0,3528 | 0,0176 |
| A12- | Telfs West | Telfs Ost | 0,60 | 0,1077 | 0,0019 | 0,60 | 0,1077 | 0,0030 | 0,84 | 0,1508 | 0,0043 | 0,84 | 0,1508 | 0,0068 | 1,21 | 0,1723 | 0,0055 | 1,21 | 0,1723 | 0,0086 |
| A12- | Mötz Reutte | Telfs West | 1,94 | 0,3480 | 0,0061 | 1,94 | 0,3480 | 0,0096 | 2,72 | 0,4872 | 0,0140 | 2,73 | 0,4872 | 0,0220 | 3,90 | 0,5568 | 0,0177 | 3,91 | 0,5568 | 0,0278 |
| A12- | Haiming Ötztal | Mötz Reutte | 2,26 | 0,4048 | 0,0071 | 2,26 | 0,4048 | 0,0111 | 3,16 | 0,5667 | 0,0163 | 3,17 | 0,5667 | 0,0256 | 4,54 | 0,6477 | 0,0205 | 4,55 | 0,6477 | 0,0323 |
| A12- | Imst | Haiming Ötztal | 1,80 | 0,3222 | 0,0056 | 1,80 | 0,3222 | 0,0089 | 2,52 | 0,4511 | 0,0130 | 2,53 | 0,4511 | 0,0204 | 3,61 | 0,5156 | 0,0164 | 3,62 | 0,5156 | 0,0257 |
| A12- | Imst Au | Imst | 0,53 | 0,0950 | 0,0017 | 0,53 | 0,0950 | 0,0026 | 0,74 | 0,1331 | 0,0038 | 0,75 | 0,1331 | 0,0060 | 1,07 | 0,1521 | 0,0048 | 1,07 | 0,1521 | 0,0076 |
| A12- | Mils | Imst Au | 0,43 | 0,0767 | 0,0013 | 0,43 | 0,0767 | 0,0021 | 0,60 | 0,1074 | 0,0031 | 0,60 | 0,1074 | 0,0049 | 0,86 | 0,1228 | 0,0039 | 0,86 | 0,1228 | 0,0061 |
| A12- | Mils Schönwies | Mils | 1,05 | 0,1888 | 0,0033 | 1,05 | 0,1888 | 0,0052 | 1,48 | 0,2643 | 0,0076 | 1,48 | 0,2643 | 0,0119 | 2,12 | 0,3021 | 0,0096 | 2,12 | 0,3021 | 0,0151 |
| A12- | KN Oberinntal | Mils Schönwies | 0,93 | 0,1672 | 0,0029 | 0,93 | 0,1672 | 0,0046 | 1,31 | 0,2341 | 0,0067 | 1,31 | 0,2341 | 0,0106 | 1,88 | 0,2675 | 0,0085 | 1,88 | 0,2675 | 0,0133 |
| A12- | Zams | KN Oberinntal | 0,25 | 0,0440 | 0,0008 | 0,25 | 0,0440 | 0,0012 | 0,34 | 0,0616 | 0,0018 | 0,35 | 0,0616 | 0,0028 | 0,49 | 0,0704 | 0,0022 | 0,49 | 0,0704 | 0,0035 |
| A122 | Fließ | KN Oberinntal | 1,74 | 0,3128 | 0,0055 | 1,75 | 0,3128 | 0,0086 | 2,45 | 0,4379 | 0,0126 | 2,45 | 0,4379 | 0,0198 | 3,51 | 0,5005 | 0,0159 | 3,52 | 0,5005 | 0,0249 |
| A13- | A13 Innsbruck Süd | A12 Innsbruck Ost | 2,20 | 0,0000 | 0,0000 | 2,20 | 0,0000 | 0,0000 | 3,08 | 0,0000 | 0,0000 | 3,08 | 0,0000 | 0,0000 | 4,62 | 0,0000 | 0,0000 | 8,50 | 0,0000 | 0,0000 |
| A13- | Zenzenhof | A13 Innsbruck Süd | 0,88 | 0,0000 | 0,0000 | 0,88 | 0,0000 | 0,0000 | 1,23 | 0,0000 | 0,0000 | 1,23 | 0,0000 | 0,0000 | 1,84 | 0,0000 | 0,0000 | 3,68 | 0,0000 | 0,0000 |
| A13- | Igls Patsch | Zenzenhof | 1,62 | 0,0000 | 0,0000 | 1,62 | 0,0000 | 0,0000 | 2,27 | 0,0000 | 0,0000 | 2,27 | 0,0000 | 0,0000 | 3,41 | 0,0000 | 0,0000 | 6,82 | 0,0000 | 0,0000 |
| A13- | Schönberg Stubaital | Igls Patsch | 1,76 | 0,0000 | 0,0000 | 1,76 | 0,0000 | 0,0000 | 2,46 | 0,0000 | 0,0000 | 2,46 | 0,0000 | 0,0000 | 3,69 | 0,0000 | 0,0000 | 7,38 | 0,0000 | 0,0000 |
| A13- | Matrei Steinach | Schönberg Stubaital | 5,54 | 0,0000 | 0,0000 | 5,54 | 0,0000 | 0,0000 | 7,76 | 0,0000 | 0,0000 | 7,76 | 0,0000 | 0,0000 | 11,63 | 0,0000 | 0,0000 | 23,26 | 0,0000 | 0,0000 |
| A13- | Nösslach | Matrei Steinach | 4,46 | 0,0000 | 0,0000 | 4,46 | 0,0000 | 0,0000 | 6,24 | 0,0000 | 0,0000 | 6,24 | 0,0000 | 0,0000 | 9,36 | 0,0000 | 0,0000 | 18,72 | 0,0000 | 0,0000 |
| A13- | Brenner-Nord | Nösslach | 4,00 | 0,0000 | 0,0000 | 4,00 | 0,0000 | 0,0000 | 5,60 | 0,0000 | 0,0000 | 5,60 | 0,0000 | 0,0000 | 8,40 | 0,0000 | 0,0000 | 16,80 | 0,0000 | 0,0000 |
| A13- | Staatsgrenze Brennerpass | Brenner-Nord | 0,79 | 0,0000 | 0,0000 | 0,79 | 0,0000 | 0,0000 | 1,11 | 0,0000 | 0,0000 | 1,11 | 0,0000 | 0,0000 | 1,66 | 0,0000 | 0,0000 | 3,32 | 0,0000 | 0,0000 |
| A131 | A13 Innsbruck Süd | A12 Innsbruck West | 1,43 | 0,0416 | 0,0007 | 1,43 | 0,0416 | 0,0011 | 2,01 | 0,0583 | 0,0017 | 2,01 | 0,0583 | 0,0026 | 2,99 | 0,0666 | 0,0021 | 5,51 | 0,0666 | 0,0033 |
| A14- | Hörbranz Lochau | Staatsgrenze Hörbranz | 0,28 | 0,0504 | 0,0009 | 0,28 | 0,0504 | 0,0014 | 0,39 | 0,0706 | 0,0020 | 0,40 | 0,0706 | 0,0032 | 0,57 | 0,0807 | 0,0026 | 0,57 | 0,0807 | 0,0040 |
| A14- | KN Bregenz | Hörbranz Lochau | 1,73 | 0,3100 | 0,0054 | 1,73 | 0,3100 | 0,0085 | 2,42 | 0,4339 | 0,0125 | 2,43 | 0,4339 | 0,0196 | 3,48 | 0,4959 | 0,0157 | 3,49 | 0,4959 | 0,0247 |
| A14- | Lauterach Wolfurt | KN Bregenz | 0,09 | 0,0156 | 0,0003 | 0,09 | 0,0156 | 0,0004 | 0,12 | 0,0218 | 0,0006 | 0,12 | 0,0218 | 0,0010 | 0,17 | 0,0249 | 0,0008 | 0,17 | 0,0249 | 0,0012 |
| A14- | Wolfurt Lauterach | Lauterach Wolfurt | 0,77 | 0,1379 | 0,0024 | 0,77 | 0,1379 | 0,0038 | 1,08 | 0,1931 | 0,0056 | 1,08 | 0,1931 | 0,0087 | 1,55 | 0,2207 | 0,0070 | 1,55 | 0,2207 | 0,0110 |
| A14- | Dornbirn Nord Bregenzerwald | Wolfurt Lauterach | 0,30 | 0,0534 | 0,0009 | 0,30 | 0,0534 | 0,0015 | 0,42 | 0,0747 | 0,0021 | 0,42 | 0,0747 | 0,0034 | 0,60 | 0,0854 | 0,0027 | 0,60 | 0,0854 | 0,0043 |
| A14- | Dornbirn Süd Lustenau | Dornbirn Nord Bregenzerwald | 0,83 | 0,1491 | 0,0026 | 0,83 | 0,1491 | 0,0041 | 1,17 | 0,2087 | 0,0060 | 1,17 | 0,2087 | 0,0094 | 1,67 | 0,2385 | 0,0076 | 1,68 | 0,2385 | 0,0119 |
| A14- | Hohenems | Dornbirn Süd Lustenau | 1,17 | 0,2098 | 0,0037 | 1,17 | 0,2098 | 0,0058 | 1,64 | 0,2937 | 0,0084 | 1,64 | 0,2937 | 0,0133 | 2,35 | 0,3356 | 0,0106 | 2,36 | 0,3356 | 0,0167 |
| A14- | Altach Götzis | Hohenems | 0,76 | 0,1368 | 0,0024 | 0,76 | 0,1368 | 0,0038 | 1,07 | 0,1915 | 0,0055 | 1,07 | 0,1915 | 0,0087 | 1,53 | 0,2188 | 0,0069 | 1,54 | 0,2188 | 0,0109 |
| A14- | Götzis | Altach Götzis | 0,58 | 0,1043 | 0,0018 | 0,58 | 0,1043 | 0,0029 | 0,82 | 0,1460 | 0,0042 | 0,82 | 0,1460 | 0,0066 | 1,17 | 0,1668 | 0,0053 | 1,17 | 0,1668 | 0,0083 |
| A14- | Klaus Koblach | Götzis | 0,50 | 0,0906 | 0,0016 | 0,51 | 0,0906 | 0,0025 | 0,71 | 0,1268 | 0,0036 | 0,71 | 0,1268 | 0,0057 | 1,02 | 0,1449 | 0,0046 | 1,02 | 0,1449 | 0,0072 |
| A14- | Rankweil | Klaus Koblach | 0,89 | 0,1592 | 0,0028 | 0,89 | 0,1592 | 0,0044 | 1,24 | 0,2228 | 0,0064 | 1,25 | 0,2228 | 0,0101 | 1,79 | 0,2547 | 0,0081 | 1,79 | 0,2547 | 0,0127 |
| A14- | Feldkirch Frastanz | Rankweil | 1,26 | 0,2267 | 0,0040 | 1,27 | 0,2267 | 0,0062 | 1,77 | 0,3174 | 0,0091 | 1,78 | 0,3174 | 0,0143 | 2,54 | 0,3628 | 0,0115 | 2,55 | 0,3628 | 0,0181 |
| A14- | Nenzing Bludesch | Feldkirch Frastanz | 2,00 | 0,3585 | 0,0063 | 2,00 | 0,3585 | 0,0099 | 2,80 | 0,5019 | 0,0144 | 2,81 | 0,5019 | 0,0227 | 4,02 | 0,5736 | 0,0182 | 4,03 | 0,5736 | 0,0286 |
| A14- | Nenzing Nüziders | Nenzing Bludesch | 1,48 | 0,2662 | 0,0047 | 1,49 | 0,2662 | 0,0073 | 2,08 | 0,3726 | 0,0107 | 2,09 | 0,3726 | 0,0168 | 2,99 | 0,4259 | 0,0135 | 2,99 | 0,4259 | 0,0212 |
| A14- | Brandnertal | Nenzing Nüziders | 0,21 | 0,0370 | 0,0006 | 0,21 | 0,0370 | 0,0010 | 0,29 | 0,0519 | 0,0015 | 0,29 | 0,0519 | 0,0023 | 0,42 | 0,0593 | 0,0019 | 0,42 | 0,0593 | 0,0030 |
| A14- | Bludenz Bürs | Brandnertal | 0,34 | 0,0618 | 0,0011 | 0,35 | 0,0618 | 0,0017 | 0,48 | 0,0865 | 0,0025 | 0,48 | 0,0865 | 0,0039 | 0,69 | 0,0989 | 0,0031 | 0,69 | 0,0989 | 0,0049 |
| A14- | Bludenz Montafon | Bludenz Bürs | 0,49 | 0,0876</ | | | | | | | | | | | | | | | | |

| | | | | | | | | | | | | | | | | | | | | |
|------|--------------------------------------|--------------------------------------|------|--------|--------|------|--------|--------|------|--------|--------|------|--------|--------|------|--------|--------|------|--------|--------|
| A22- | Strebersdorf | KN Gürtel Nordbrücke | 0,67 | 0,1203 | 0,0021 | 0,67 | 0,1203 | 0,0033 | 0,94 | 0,1684 | 0,0048 | 0,94 | 0,1684 | 0,0076 | 1,35 | 0,1925 | 0,0061 | 1,35 | 0,1925 | 0,0096 |
| A221 | KN Gürtel Nordbrücke | Wien Nordbrücke | 0,20 | 0,0355 | 0,0006 | 0,20 | 0,0355 | 0,0010 | 0,28 | 0,0497 | 0,0014 | 0,28 | 0,0497 | 0,0022 | 0,40 | 0,0568 | 0,0018 | 0,40 | 0,0568 | 0,0028 |
| A221 | Wien Pragerstraße | KN Gürtel Nordbrücke | 0,21 | 0,0382 | 0,0007 | 0,21 | 0,0382 | 0,0011 | 0,30 | 0,0535 | 0,0015 | 0,30 | 0,0535 | 0,0024 | 0,43 | 0,0611 | 0,0019 | 0,43 | 0,0611 | 0,0030 |
| A221 | Wien Neujedlersdorf | Wien Pragerstraße | 0,09 | 0,0167 | 0,0003 | 0,09 | 0,0167 | 0,0005 | 0,13 | 0,0234 | 0,0007 | 0,13 | 0,0234 | 0,0011 | 0,19 | 0,0268 | 0,0008 | 0,19 | 0,0268 | 0,0013 |
| A221 | Brünnerstr/Shuttlewort hstraße | Wien Neujedlersdorf | 0,24 | 0,0424 | 0,0007 | 0,24 | 0,0424 | 0,0012 | 0,33 | 0,0594 | 0,0017 | 0,33 | 0,0594 | 0,0027 | 0,48 | 0,0678 | 0,0022 | 0,48 | 0,0678 | 0,0034 |
| A22- | Korneuburg Ost | Strebersdorf | 1,35 | 0,2424 | 0,0042 | 1,35 | 0,2424 | 0,0067 | 1,90 | 0,3394 | 0,0098 | 1,90 | 0,3394 | 0,0153 | 2,72 | 0,3878 | 0,0123 | 2,72 | 0,3878 | 0,0193 |
| A222 | Wien Vohburggasse | Strebersdorf | 0,17 | 0,0301 | 0,0005 | 0,17 | 0,0301 | 0,0008 | 0,24 | 0,0422 | 0,0012 | 0,24 | 0,0422 | 0,0019 | 0,34 | 0,0482 | 0,0015 | 0,34 | 0,0482 | 0,0024 |
| A22- | KN Korneuburg | Korneuburg Ost | 0,87 | 0,1564 | 0,0027 | 0,87 | 0,1564 | 0,0043 | 1,22 | 0,2190 | 0,0063 | 1,23 | 0,2190 | 0,0099 | 1,75 | 0,2503 | 0,0079 | 1,76 | 0,2503 | 0,0125 |
| A22- | Stockerau Ost | KN Korneuburg | 1,27 | 0,2276 | 0,0040 | 1,27 | 0,2276 | 0,0063 | 1,78 | 0,3186 | 0,0092 | 1,78 | 0,3186 | 0,0144 | 2,55 | 0,3642 | 0,0116 | 2,56 | 0,3642 | 0,0182 |
| A22- | Stockerau Mitte | Stockerau Ost | 0,51 | 0,0908 | 0,0016 | 0,51 | 0,0908 | 0,0025 | 0,71 | 0,1271 | 0,0037 | 0,71 | 0,1271 | 0,0057 | 1,02 | 0,1452 | 0,0046 | 1,02 | 0,1452 | 0,0072 |
| A22- | KN Stockerau/West | Stockerau Mitte | 0,43 | 0,0771 | 0,0013 | 0,43 | 0,0771 | 0,0021 | 0,60 | 0,1079 | 0,0031 | 0,60 | 0,1079 | 0,0049 | 0,86 | 0,1233 | 0,0039 | 0,87 | 0,1233 | 0,0061 |
| A23- | KN Wien Inzersdorf | Altmannsdorferstraße | 0,38 | 0,0674 | 0,0012 | 0,38 | 0,0674 | 0,0019 | 0,53 | 0,0944 | 0,0027 | 0,53 | 0,0944 | 0,0043 | 0,76 | 0,1079 | 0,0034 | 0,76 | 0,1079 | 0,0054 |
| A23- | Favoriten | KN Wien Inzersdorf | 0,95 | 0,1701 | 0,0030 | 0,95 | 0,1701 | 0,0047 | 1,33 | 0,2381 | 0,0068 | 1,33 | 0,2381 | 0,0108 | 1,91 | 0,2721 | 0,0086 | 1,91 | 0,2721 | 0,0136 |
| A23- | KN Gürtel Landstraßer Hauptstraße | Favoriten | 0,59 | 0,1065 | 0,0019 | 0,59 | 0,1065 | 0,0029 | 0,83 | 0,1491 | 0,0043 | 0,84 | 0,1491 | 0,0067 | 1,19 | 0,1704 | 0,0054 | 1,20 | 0,1704 | 0,0085 |
| A23- | St. Marx | KN Gürtel Landstraßer Hauptstraße | 0,23 | 0,0404 | 0,0007 | 0,23 | 0,0404 | 0,0011 | 0,32 | 0,0566 | 0,0016 | 0,32 | 0,0566 | 0,0026 | 0,45 | 0,0647 | 0,0021 | 0,45 | 0,0647 | 0,0032 |
| A23- | KN Wien Prater | St. Marx | 0,19 | 0,0343 | 0,0006 | 0,19 | 0,0343 | 0,0009 | 0,27 | 0,0480 | 0,0014 | 0,27 | 0,0480 | 0,0022 | 0,38 | 0,0549 | 0,0017 | 0,39 | 0,0549 | 0,0027 |
| A23- | Handelskai | KN Wien Prater | 0,42 | 0,0762 | 0,0013 | 0,43 | 0,0762 | 0,0021 | 0,60 | 0,1067 | 0,0031 | 0,60 | 0,1067 | 0,0048 | 0,85 | 0,1219 | 0,0039 | 0,86 | 0,1219 | 0,0061 |
| A23- | KN Wien Kaisermühlen | Handelskai | 0,19 | 0,0348 | 0,0006 | 0,19 | 0,0348 | 0,0010 | 0,27 | 0,0488 | 0,0014 | 0,27 | 0,0488 | 0,0022 | 0,39 | 0,0557 | 0,0018 | 0,39 | 0,0557 | 0,0028 |
| A23- | Groß Enzersdorf Stadlau | KN Wien Kaisermühlen | 0,53 | 0,0956 | 0,0017 | 0,53 | 0,0956 | 0,0026 | 0,75 | 0,1338 | 0,0038 | 0,75 | 0,1338 | 0,0060 | 1,07 | 0,1530 | 0,0049 | 1,08 | 0,1530 | 0,0076 |
| A23- | Hirschstetten | Groß Enzersdorf Stadlau | 0,30 | 0,0536 | 0,0009 | 0,30 | 0,0536 | 0,0015 | 0,42 | 0,0750 | 0,0022 | 0,42 | 0,0750 | 0,0034 | 0,60 | 0,0858 | 0,0027 | 0,60 | 0,0858 | 0,0043 |
| A233 | Wien Gürtel | KN Gürtel Landstraßer Hauptstraße | 0,17 | 0,0313 | 0,0005 | 0,17 | 0,0313 | 0,0009 | 0,24 | 0,0438 | 0,0013 | 0,25 | 0,0438 | 0,0020 | 0,35 | 0,0500 | 0,0016 | 0,35 | 0,0500 | 0,0025 |
| A25- | Weißkirchen | KN A1/A25 Passau Wels | 1,96 | 0,3526 | 0,0062 | 1,97 | 0,3526 | 0,0097 | 2,76 | 0,4936 | 0,0142 | 2,76 | 0,4936 | 0,0223 | 3,95 | 0,5642 | 0,0179 | 3,97 | 0,5642 | 0,0281 |
| A25- | Marchtrenk Wels Ost | Weißkirchen | 0,70 | 0,1256 | 0,0022 | 0,70 | 0,1256 | 0,0035 | 0,98 | 0,1759 | 0,0051 | 0,99 | 0,1759 | 0,0079 | 1,41 | 0,2010 | 0,0064 | 1,41 | 0,2010 | 0,0100 |
| A25- | ÖBB Terminal Wels | Marchtrenk Wels Ost | 0,19 | 0,0338 | 0,0006 | 0,19 | 0,0338 | 0,0009 | 0,26 | 0,0473 | 0,0014 | 0,26 | 0,0473 | 0,0021 | 0,38 | 0,0541 | 0,0017 | 0,38 | 0,0541 | 0,0027 |
| A25- | Wels Nord | ÖBB Terminal Wels | 0,90 | 0,1620 | 0,0028 | 0,90 | 0,1620 | 0,0045 | 1,27 | 0,2269 | 0,0065 | 1,27 | 0,2269 | 0,0102 | 1,82 | 0,2593 | 0,0082 | 1,82 | 0,2593 | 0,0129 |
| A25- | KN Wels | Wels Nord | 0,64 | 0,1153 | 0,0020 | 0,64 | 0,1153 | 0,0032 | 0,90 | 0,1614 | 0,0046 | 0,90 | 0,1614 | 0,0073 | 1,29 | 0,1844 | 0,0059 | 1,30 | 0,1844 | 0,0092 |
| S01- | Vorarlberger Allee | KN Vösendorf | 0,48 | 0,0855 | 0,0015 | 0,48 | 0,0855 | 0,0024 | 0,67 | 0,1197 | 0,0034 | 0,67 | 0,1197 | 0,0054 | 0,96 | 0,1368 | 0,0043 | 0,96 | 0,1368 | 0,0068 |
| S01- | Laxenburger Str. | Vorarlberger Allee | 0,25 | 0,0449 | 0,0008 | 0,25 | 0,0449 | 0,0012 | 0,35 | 0,0628 | 0,0018 | 0,35 | 0,0628 | 0,0028 | 0,50 | 0,0718 | 0,0023 | 0,50 | 0,0718 | 0,0036 |
| S01- | Güterzentrum Wien Süd | Laxenburger Str. | 0,31 | 0,0556 | 0,0010 | 0,31 | 0,0556 | 0,0015 | 0,43 | 0,0779 | 0,0022 | 0,44 | 0,0779 | 0,0035 | 0,62 | 0,0890 | 0,0028 | 0,63 | 0,0890 | 0,0044 |
| S01- | Rothneusiedl | Güterzentrum Wien Süd | 0,20 | 0,0362 | 0,0006 | 0,20 | 0,0362 | 0,0010 | 0,28 | 0,0506 | 0,0015 | 0,28 | 0,0506 | 0,0023 | 0,41 | 0,0579 | 0,0018 | 0,41 | 0,0579 | 0,0029 |
| S01- | KN Rustenfeld | Rothneusiedl | 0,47 | 0,0846 | 0,0015 | 0,47 | 0,0846 | 0,0023 | 0,66 | 0,1184 | 0,0034 | 0,66 | 0,1184 | 0,0054 | 0,95 | 0,1354 | 0,0043 | 0,95 | 0,1354 | 0,0067 |
| S01- | Rannersdorf | KN Rustenfeld | 0,66 | 0,1187 | 0,0021 | 0,66 | 0,1187 | 0,0033 | 0,93 | 0,1662 | 0,0048 | 0,93 | 0,1662 | 0,0075 | 1,33 | 0,1900 | 0,0060 | 1,34 | 0,1900 | 0,0095 |
| S011 | Leopoldsdorf (B16) | KN Rustenfeld | 0,29 | 0,0526 | 0,0009 | 0,29 | 0,0526 | 0,0014 | 0,41 | 0,0736 | 0,0021 | 0,41 | 0,0736 | 0,0033 | 0,59 | 0,0842 | 0,0027 | 0,59 | 0,0842 | 0,0042 |
| S01- | Schwechat Süd | Rannersdorf | 0,52 | 0,0928 | 0,0016 | 0,52 | 0,0928 | 0,0026 | 0,73 | 0,1299 | 0,0037 | 0,73 | 0,1299 | 0,0059 | 1,04 | 0,1484 | 0,0047 | 1,04 | 0,1484 | 0,0074 |
| S01- | Schwechat Ost | Schwechat Süd | 0,30 | 0,0531 | 0,0009 | 0,30 | 0,0531 | 0,0015 | 0,42 | 0,0744 | 0,0021 | 0,42 | 0,0744 | 0,0034 | 0,60 | 0,0850 | 0,0027 | 0,60 | 0,0850 | 0,0042 |
| S01- | Mannswörth | Schwechat Ost | 0,31 | 0,0562 | 0,0010 | 0,31 | 0,0562 | 0,0015 | 0,44 | 0,0787 | 0,0023 | 0,44 | 0,0787 | 0,0036 | 0,63 | 0,0900 | 0,0029 | 0,63 | 0,0900 | 0,0045 |
| S01- | KN Schwechat | Mannswörth | 0,12 | 0,0211 | 0,0004 | 0,12 | 0,0211 | 0,0006 | 0,16 | 0,0295 | 0,0008 | 0,17 | 0,0295 | 0,0013 | 0,24 | 0,0337 | 0,0011 | 0,24 | 0,0337 | 0,0017 |
| S01- | Seyring | Angerner Straße | 1,10 | 0,1971 | 0,0034 | 1,10 | 0,1971 | 0,0054 | 1,54 | 0,2759 | 0,0079 | 1,55 | 0,2759 | 0,0125 | 2,21 | 0,3153 | 0,0100 | 2,22 | 0,3153 | 0,0157 |
| S01- | KN Eibesbrunn | Seyring | 0,92 | 0,1649 | 0,0029 | 0,92 | 0,1649 | 0,0045 | 1,29 | 0,2308 | 0,0066 | 1,29 | 0,2308 | 0,0104 | 1,85 | 0,2638 | 0,0084 | 1,85 | 0,2638 | 0,0131 |
| S01- | Hagenbrunn | KN Eibesbrunn | 0,72 | 0,1298 | 0,0023 | 0,72 | 0,1298 | 0,0036 | 1,01 | 0,1817 | 0,0052 | 1,02 | 0,1817 | 0,0082 | 1,46 | 0,2077 | 0,0066 | 1,46 | 0,2077 | 0,0104 |
| S01- | Korneuburg Nord | Hagenbrunn | 1,55 | 0,2777 | 0,0049 | 1,55 | 0,2777 | 0,0076 | 2,17 | 0,3888 | 0,0112 | 2,18 | 0,3888 | 0,0176 | 3,11 | 0,4443 | 0,0141 | 3,12 | 0,4443 | 0,0221 |
| S01- | Korneuburg West | Korneuburg Nord | 0,63 | 0,1126 | 0,0020 | 0,63 | 0,1126 | 0,0031 | 0,88 | 0,1577 | 0,0045 | 0,88 | 0,1577 | 0,0071 | 1,26 | 0,1802 | 0,0057 | 1,27 | 0,1802 | 0,0090 |
| S01- | KN Korneuburg | Korneuburg West | 0,20 | 0,0359 | 0,0006 | 0,20 | 0,0359 | 0,0010 | 0,28 | 0,0503 | 0,0014 | 0,28 | 0,0503 | 0,0023 | 0,40 | 0,0575 | 0,0018 | 0,40 | 0,0575 | 0,0029 |
| S02- | Gewerbepark Stadlau | Hirschstetten | 0,22 | 0,0386 | 0,0007 | 0,22 | 0,0386 | 0,0011 | 0,30 | 0,0540 | 0,0016 | 0,30 | 0,0540 | 0,0024 | 0,43 | 0,0618 | 0,0020 | 0,43 | 0,0618 | 0,0031 |
| S02- | Breitenleer Straße | Gewerbepark Stadlau | 0,12 | 0,0214 | 0,0004 | 0,12 | 0,0214 | 0,0006 | 0,17 | 0,0300 | 0,0009 | 0,17 | 0,0300 | 0,0014 | 0,24 | 0,0342 | 0,0011 | 0,24 | 0,0342 | 0,0017 |
| S02- | Rautenweg | Breitenleer Straße | 0,20 | 0,0355 | 0,0006 | 0,20 | 0,0355 | 0,0010 | 0,28 | 0,0497 | 0,0014 | 0,28 | 0,0497 | 0,0022 | 0,40 | 0,0568 | 0,0018 | 0,40 | 0,0568 | 0,0028 |
| S02- | Hermann Gebauer Straße | Rautenweg | 0,22 | 0,0390 | 0,0007 | 0,22 | 0,0390 | 0,0011 | 0,31 | 0,0547 | 0,0016 | 0,31 | 0,0547 | 0,0025 | 0,44 | 0,0625 | 0,0020 | 0,44 | 0,0625 | 0,0031 |
| S02- | Angerner Straße | Hermann Gebauer Straße | 0,79 | 0,1413 | 0,0025 | 0,79 | 0,1413 | 0,0039 | 1,10 | 0,1978 | 0,0057 | 1,11 | 0,1978 | 0,0089 | 1,58 | 0,2260 | 0,0072 | 1,59 | 0,2260 | 0,0113 |
| S03- | Stockerau Nord | KN Stockerau/West | 0,22 | 0,0399 | 0,0007 | 0,22 | 0,0399 | 0,0011 | 0,31 | 0,0559 | 0,0016 | 0,31 | 0,0559 | 0,0025 | 0,45 | 0,0639 | 0,0020 | 0,45 | 0,0639 | 0,0032 |
| S03- | Sierndorf | Stockerau Nord | 1,20 | 0,2146 | 0,0038 | 1,20 | 0,2146 | 0,0059 | 1,68 | 0,3004 | 0,0086 | 1,68 | 0,3004 | 0,0136 | 2,41 | 0,3433 | 0,0109 | 2,41 | 0,3433 | 0,0171 |
| S03- | Obermallebarn | Sierndorf | 0,80 | 0,1441 | 0,0025 | 0,80 | 0,1441 | 0,0040 | 1,13 | 0,2017 | 0,0058 | 1,13 | 0,2017 | 0,0091 | 1,62 | 0,2305 | 0,0073 | 1,62 | 0,2305 | 0,0115 |
| S03- | Göllersdorf | Obermallebarn | 1,06 | 0,1902 | 0,0033 | 1,06 | 0,1902 | 0,0052 | 1,49 | 0,2663 | 0,0077 | 1,49 | 0,2663 | 0,0120 | 2,13 | 0,3044 | 0,0097 | 2,14 | 0,3044 | 0,0152 |
| S03- | Großstelzendorf | Göllersdorf | 0,42 | 0,0762 | 0,0013 | 0,43 | 0,0762 | 0,0021 | 0,60 | 0,1067 | 0,0031 | 0,60 | 0,1067 | 0,0048 | 0,85 | 0,1219 | 0,0039 | 0,86 | 0,1219 | 0,0061 |
| S03- | Hollabrunn Süd | Großstelzendorf | 1,02 | 0,1832 | 0,0032 | 1,02 | 0,1832 | 0,0050 | 1,43 | 0,2565 | 0,0074 | 1,44 | 0,2565 | 0,0116 | 2,06 | 0,2932 | 0,0093 | 2,06 | 0,2932 | 0,0146 |
| S04- | Sigleß | KN Mattersburg | 0,53 | 0,0947 | 0,0017 | 0,53 | 0,0947 | 0,0026 | 0,74 | 0,1326 | 0,0038 | 0,74 | 0,1326 | 0,0060 | 1,06 | 0,1516 | 0,0048 | 1,07 | 0,1516 | 0,0076 |
| S04- | Bad Sauerbrunn | Sigleß | 1,23 | 0,2213 | 0,0039 | 1,24 | 0,2213 | 0,0061 | 1,73 | 0,3098 | 0,0089 | 1,74 | 0,3098 | 0,0140 | 2,48 | 0,3541 | 0,0112 | 2,49 | 0,3541 | 0,0177 |
| S04- | | | | | | | | | | | | | | | | | | | | |

| | | | | | | | | | | | | | | | | | | | | |
|------|-----------------------------------|-----------------------------------|------|--------|--------|------|--------|--------|-------|--------|--------|-------|--------|--------|-------|--------|--------|-------|--------|--------|
| S06- | Gloggnitz | Neunkirchen | 2,71 | 0,4868 | 0,0085 | 2,72 | 0,4868 | 0,0134 | 3,81 | 0,6815 | 0,0196 | 3,82 | 0,6815 | 0,0308 | 5,46 | 0,7789 | 0,0247 | 5,47 | 0,7789 | 0,0388 |
| S06- | Maria Schutz | Gloggnitz | 1,73 | 0,3103 | 0,0054 | 1,73 | 0,3103 | 0,0085 | 2,43 | 0,4344 | 0,0125 | 2,43 | 0,4344 | 0,0196 | 3,48 | 0,4964 | 0,0157 | 3,49 | 0,4964 | 0,0247 |
| S06- | Spital / Semmering | Maria Schutz | 1,47 | 0,2634 | 0,0046 | 1,47 | 0,2634 | 0,0072 | 2,06 | 0,3687 | 0,0106 | 2,06 | 0,3687 | 0,0167 | 2,95 | 0,4214 | 0,0134 | 2,96 | 0,4214 | 0,0210 |
| S06- | Mürzzuschlag Ost | Spital / Semmering | 1,23 | 0,2200 | 0,0039 | 1,23 | 0,2200 | 0,0061 | 1,72 | 0,3080 | 0,0089 | 1,72 | 0,3080 | 0,0139 | 2,47 | 0,3520 | 0,0112 | 2,47 | 0,3520 | 0,0175 |
| S06- | Mariazell, Mürzsteg, Mürzzuschlag | Mürzzuschlag Ost | 1,09 | 0,1950 | 0,0034 | 1,09 | 0,1950 | 0,0054 | 1,52 | 0,2731 | 0,0079 | 1,53 | 0,2731 | 0,0123 | 2,19 | 0,3121 | 0,0099 | 2,19 | 0,3121 | 0,0156 |
| S06- | Hönigsberg | Mariazell, Mürzsteg, Mürzzuschlag | 0,78 | 0,1391 | 0,0024 | 0,78 | 0,1391 | 0,0038 | 1,09 | 0,1947 | 0,0056 | 1,09 | 0,1947 | 0,0088 | 1,56 | 0,2225 | 0,0071 | 1,56 | 0,2225 | 0,0111 |
| S06- | Langenwang | Hönigsberg | 0,43 | 0,0769 | 0,0013 | 0,43 | 0,0769 | 0,0021 | 0,60 | 0,1077 | 0,0031 | 0,60 | 0,1077 | 0,0049 | 0,86 | 0,1231 | 0,0039 | 0,87 | 0,1231 | 0,0061 |
| S06- | Krieglach | Langenwang | 0,51 | 0,0914 | 0,0016 | 0,51 | 0,0914 | 0,0025 | 0,71 | 0,1279 | 0,0037 | 0,72 | 0,1279 | 0,0058 | 1,02 | 0,1462 | 0,0046 | 1,03 | 0,1462 | 0,0073 |
| S06- | Mitterdorf | Krieglach | 1,29 | 0,2309 | 0,0040 | 1,29 | 0,2309 | 0,0064 | 1,81 | 0,3233 | 0,0093 | 1,81 | 0,3233 | 0,0146 | 2,59 | 0,3695 | 0,0117 | 2,60 | 0,3695 | 0,0184 |
| S06- | Kindberg Ost | Mitterdorf | 1,31 | 0,2348 | 0,0041 | 1,31 | 0,2348 | 0,0065 | 1,84 | 0,3287 | 0,0095 | 1,84 | 0,3287 | 0,0149 | 2,63 | 0,3757 | 0,0119 | 2,64 | 0,3757 | 0,0187 |
| S06- | Kindberg West | Kindberg Ost | 0,28 | 0,0504 | 0,0009 | 0,28 | 0,0504 | 0,0014 | 0,39 | 0,0706 | 0,0020 | 0,40 | 0,0706 | 0,0032 | 0,57 | 0,0806 | 0,0026 | 0,57 | 0,0806 | 0,0040 |
| S06- | Kindberg Dörfel | Kindberg West | 0,28 | 0,0504 | 0,0009 | 0,28 | 0,0504 | 0,0014 | 0,39 | 0,0705 | 0,0020 | 0,39 | 0,0705 | 0,0032 | 0,56 | 0,0806 | 0,0026 | 0,57 | 0,0806 | 0,0040 |
| S06- | Allerheiligen Mürzhofen | Kindberg Dörfel | 0,63 | 0,1134 | 0,0020 | 0,63 | 0,1134 | 0,0031 | 0,89 | 0,1588 | 0,0046 | 0,89 | 0,1588 | 0,0072 | 1,27 | 0,1815 | 0,0058 | 1,28 | 0,1815 | 0,0090 |
| S06- | St. Marein | Allerheiligen Mürzhofen | 0,95 | 0,1704 | 0,0030 | 0,95 | 0,1704 | 0,0047 | 1,33 | 0,2386 | 0,0069 | 1,34 | 0,2386 | 0,0108 | 1,91 | 0,2726 | 0,0086 | 1,92 | 0,2726 | 0,0136 |
| S06- | Kapfenberg | St. Marein | 0,67 | 0,1208 | 0,0021 | 0,67 | 0,1208 | 0,0033 | 0,94 | 0,1691 | 0,0049 | 0,95 | 0,1691 | 0,0076 | 1,35 | 0,1933 | 0,0061 | 1,36 | 0,1933 | 0,0096 |
| S06- | KN Bruck/Mur | Kapfenberg | 1,26 | 0,2255 | 0,0039 | 1,26 | 0,2255 | 0,0062 | 1,76 | 0,3157 | 0,0091 | 1,77 | 0,3157 | 0,0143 | 2,53 | 0,3608 | 0,0114 | 2,54 | 0,3608 | 0,0180 |
| S06- | ASt Bruck/Mur | KN Bruck/Mur | 1,08 | 0,1934 | 0,0034 | 1,08 | 0,1934 | 0,0053 | 1,51 | 0,2708 | 0,0078 | 1,52 | 0,2708 | 0,0122 | 2,17 | 0,3095 | 0,0098 | 2,18 | 0,3095 | 0,0154 |
| S06- | Niklasdorf | ASt Bruck/Mur | 1,00 | 0,1787 | 0,0031 | 1,00 | 0,1787 | 0,0049 | 1,40 | 0,2502 | 0,0072 | 1,40 | 0,2502 | 0,0113 | 2,00 | 0,2860 | 0,0091 | 2,01 | 0,2860 | 0,0143 |
| S06- | Leoben Ost | Niklasdorf | 1,06 | 0,1906 | 0,0033 | 1,06 | 0,1906 | 0,0052 | 1,49 | 0,2669 | 0,0077 | 1,49 | 0,2669 | 0,0121 | 2,14 | 0,3050 | 0,0097 | 2,14 | 0,3050 | 0,0152 |
| S06- | Leoben West | Leoben Ost | 1,19 | 0,2136 | 0,0037 | 1,19 | 0,2136 | 0,0059 | 1,67 | 0,2990 | 0,0086 | 1,67 | 0,2990 | 0,0135 | 2,40 | 0,3417 | 0,0108 | 2,40 | 0,3417 | 0,0170 |
| S06- | KN St. Michael | Leoben West | 1,47 | 0,2644 | 0,0046 | 1,48 | 0,2644 | 0,0073 | 2,07 | 0,3701 | 0,0106 | 2,07 | 0,3701 | 0,0167 | 2,97 | 0,4230 | 0,0134 | 2,97 | 0,4230 | 0,0211 |
| S10- | Neumarkt | Unterweikersdorf | 1,49 | 0,2679 | 0,0047 | 1,50 | 0,2679 | 0,0074 | 2,09 | 0,3750 | 0,0108 | 2,10 | 0,3750 | 0,0169 | 3,00 | 0,4286 | 0,0136 | 3,01 | 0,4286 | 0,0214 |
| S10- | Kefermarkt | Neumarkt | 0,86 | 0,1538 | 0,0027 | 0,86 | 0,1538 | 0,0042 | 1,20 | 0,2154 | 0,0062 | 1,21 | 0,2154 | 0,0097 | 1,73 | 0,2461 | 0,0078 | 1,73 | 0,2461 | 0,0123 |
| S10- | Freistadt / Süd | Kefermarkt | 0,92 | 0,1655 | 0,0029 | 0,92 | 0,1655 | 0,0046 | 1,29 | 0,2317 | 0,0067 | 1,30 | 0,2317 | 0,0105 | 1,86 | 0,2648 | 0,0084 | 1,86 | 0,2648 | 0,0132 |
| S10- | Grünbach Sandl | Freistadt / Süd | 0,98 | 0,1750 | 0,0031 | 0,98 | 0,1750 | 0,0048 | 1,37 | 0,2451 | 0,0070 | 1,37 | 0,2451 | 0,0111 | 1,96 | 0,2801 | 0,0089 | 1,97 | 0,2801 | 0,0140 |
| S10- | Freistadt / Nord | Grünbach Sandl | 0,27 | 0,0481 | 0,0008 | 0,27 | 0,0481 | 0,0013 | 0,38 | 0,0673 | 0,0019 | 0,38 | 0,0673 | 0,0030 | 0,54 | 0,0769 | 0,0024 | 0,54 | 0,0769 | 0,0038 |
| S16- | Landeck West | Zams | 1,14 | 0,2046 | 0,0036 | 1,14 | 0,2046 | 0,0056 | 1,60 | 0,2864 | 0,0082 | 1,60 | 0,2864 | 0,0129 | 2,29 | 0,3274 | 0,0104 | 2,30 | 0,3274 | 0,0163 |
| S16- | Pians | Landeck West | 0,73 | 0,1310 | 0,0023 | 0,73 | 0,1310 | 0,0036 | 1,02 | 0,1835 | 0,0053 | 1,03 | 0,1835 | 0,0083 | 1,47 | 0,2097 | 0,0067 | 1,47 | 0,2097 | 0,0105 |
| S16- | Flirsch | Pians | 1,45 | 0,2597 | 0,0045 | 1,45 | 0,2597 | 0,0071 | 2,03 | 0,3636 | 0,0105 | 2,04 | 0,3636 | 0,0164 | 2,91 | 0,4156 | 0,0132 | 2,92 | 0,4156 | 0,0207 |
| S16- | Schnann am Arlberg | Flirsch | 0,91 | 0,1630 | 0,0029 | 0,91 | 0,1630 | 0,0045 | 1,27 | 0,2283 | 0,0066 | 1,28 | 0,2283 | 0,0103 | 1,83 | 0,2609 | 0,0083 | 1,83 | 0,2609 | 0,0130 |
| S16- | Pettneu | Schnann am Arlberg | 0,66 | 0,1185 | 0,0021 | 0,66 | 0,1185 | 0,0033 | 0,93 | 0,1659 | 0,0048 | 0,93 | 0,1659 | 0,0075 | 1,33 | 0,1896 | 0,0060 | 1,33 | 0,1896 | 0,0095 |
| S16- | St. Anton/Arlberg | Pettneu | 0,37 | 0,0660 | 0,0012 | 0,37 | 0,0660 | 0,0018 | 0,52 | 0,0924 | 0,0027 | 0,52 | 0,0924 | 0,0042 | 0,74 | 0,1056 | 0,0033 | 0,74 | 0,1056 | 0,0053 |
| S16- | Langen/Arlberg | St. Anton/Arlberg | 8,43 | 0,6421 | 0,0112 | 8,43 | 0,6421 | 0,0177 | 11,81 | 0,8990 | 0,0258 | 11,82 | 0,8990 | 0,0406 | 17,39 | 1,0274 | 0,0326 | 17,41 | 1,0274 | 0,0512 |
| S16- | Wald/Arlberg | Langen/Arlberg | 1,17 | 0,2103 | 0,0037 | 1,17 | 0,2103 | 0,0058 | 1,64 | 0,2944 | 0,0085 | 1,65 | 0,2944 | 0,0133 | 2,36 | 0,3365 | 0,0107 | 2,37 | 0,3365 | 0,0168 |
| S16- | Dalaas | Wald/Arlberg | 1,34 | 0,2396 | 0,0042 | 1,34 | 0,2396 | 0,0066 | 1,87 | 0,3354 | 0,0096 | 1,88 | 0,3354 | 0,0152 | 2,69 | 0,3833 | 0,0122 | 2,69 | 0,3833 | 0,0191 |
| S16- | Braz Ost | Dalaas | 0,76 | 0,1358 | 0,0024 | 0,76 | 0,1358 | 0,0037 | 1,06 | 0,1901 | 0,0055 | 1,06 | 0,1901 | 0,0086 | 1,52 | 0,2173 | 0,0069 | 1,53 | 0,2173 | 0,0108 |
| S16- | Braz West | Braz Ost | 0,59 | 0,1060 | 0,0019 | 0,59 | 0,1060 | 0,0029 | 0,83 | 0,1483 | 0,0043 | 0,83 | 0,1483 | 0,0067 | 1,19 | 0,1695 | 0,0054 | 1,19 | 0,1695 | 0,0085 |
| S16- | Bings | Braz West | 0,80 | 0,1436 | 0,0025 | 0,80 | 0,1436 | 0,0039 | 1,12 | 0,2010 | 0,0058 | 1,13 | 0,2010 | 0,0091 | 1,61 | 0,2297 | 0,0073 | 1,61 | 0,2297 | 0,0114 |
| S16- | Bludenz Montafon | Bings | 0,38 | 0,0680 | 0,0012 | 0,38 | 0,0680 | 0,0019 | 0,53 | 0,0951 | 0,0027 | 0,53 | 0,0951 | 0,0043 | 0,76 | 0,1087 | 0,0034 | 0,76 | 0,1087 | 0,0054 |
| S31- | Eisenstadt Süd | Eisenstadt Ost | 0,69 | 0,1232 | 0,0022 | 0,69 | 0,1232 | 0,0034 | 0,96 | 0,1724 | 0,0050 | 0,97 | 0,1724 | 0,0078 | 1,38 | 0,1971 | 0,0063 | 1,39 | 0,1971 | 0,0098 |
| S31- | Eisenstadt Mitte | Eisenstadt Süd | 0,26 | 0,0461 | 0,0008 | 0,26 | 0,0461 | 0,0013 | 0,36 | 0,0646 | 0,0019 | 0,36 | 0,0646 | 0,0029 | 0,52 | 0,0738 | 0,0023 | 0,52 | 0,0738 | 0,0037 |
| S31- | KN Eisenstadt | Eisenstadt Mitte | 0,42 | 0,0761 | 0,0013 | 0,42 | 0,0761 | 0,0021 | 0,59 | 0,1065 | 0,0031 | 0,60 | 0,1065 | 0,0048 | 0,85 | 0,1217 | 0,0039 | 0,86 | 0,1217 | 0,0061 |
| S31- | Wulkaprodersdorf | KN Eisenstadt | 0,56 | 0,1013 | 0,0018 | 0,57 | 0,1013 | 0,0028 | 0,79 | 0,1418 | 0,0041 | 0,79 | 0,1418 | 0,0064 | 1,14 | 0,1620 | 0,0051 | 1,14 | 0,1620 | 0,0081 |
| S31- | KN Mattersburg | Wulkaprodersdorf | 1,60 | 0,2875 | 0,0050 | 1,61 | 0,2875 | 0,0079 | 2,25 | 0,4025 | 0,0116 | 2,25 | 0,4025 | 0,0182 | 3,22 | 0,4600 | 0,0146 | 3,23 | 0,4600 | 0,0229 |
| S31- | Forchtenstein | KN Mattersburg | 1,16 | 0,2081 | 0,0036 | 1,16 | 0,2081 | 0,0057 | 1,63 | 0,2914 | 0,0084 | 1,63 | 0,2914 | 0,0132 | 2,33 | 0,3330 | 0,0106 | 2,34 | 0,3330 | 0,0166 |
| S31- | Sieggraben | Forchtenstein | 1,62 | 0,2908 | 0,0051 | 1,62 | 0,2908 | 0,0080 | 2,27 | 0,4071 | 0,0117 | 2,28 | 0,4071 | 0,0184 | 3,26 | 0,4653 | 0,0148 | 3,27 | 0,4653 | 0,0232 |
| S31- | Weppersdorf/Kobersdorf | Sieggraben | 1,95 | 0,3503 | 0,0061 | 1,96 | 0,3503 | 0,0096 | 2,74 | 0,4904 | 0,0141 | 2,75 | 0,4904 | 0,0222 | 3,93 | 0,5605 | 0,0178 | 3,94 | 0,5605 | 0,0279 |
| S31- | Weppersdorf/Markt St.Martin | Weppersdorf/Kobersdorf | 0,40 | 0,0720 | 0,0013 | 0,40 | 0,0720 | 0,0020 | 0,56 | 0,1007 | 0,0029 | 0,56 | 0,1007 | 0,0046 | 0,81 | 0,1151 | 0,0037 | 0,81 | 0,1151 | 0,0057 |
| S31- | Neutal | Weppersdorf/Markt St.Martin | 0,93 | 0,1663 | 0,0029 | 0,93 | 0,1663 | 0,0046 | 1,30 | 0,2328 | 0,0067 | 1,30 | 0,2328 | 0,0105 | 1,87 | 0,2660 | 0,0084 | 1,87 | 0,2660 | 0,0133 |
| S31- | Stoob Süd | Neutal | 0,81 | 0,1453 | 0,0025 | 0,81 | 0,1453 | 0,0040 | 1,14 | 0,2034 | 0,0058 | 1,14 | 0,2034 | 0,0092 | 1,63 | 0,2324 | 0,0074 | 1,63 | 0,2324 | 0,0116 |
| S31- | Oberpullendorf | Stoob Süd | 0,88 | 0,1586 | 0,0028 | 0,89 | 0,1586 | 0,0044 | 1,24 | 0,2220 | 0,0064 | 1,24 | 0,2220 | 0,0100 | 1,78 | 0,2538 | 0,0080 | 1,78 | 0,2538 | 0,0126 |
| S33- | St. Pölten Ost | KN St. Pölten | 0,48 | 0,0861 | 0,0015 | 0,48 | 0,0861 | 0,0024 | 0,67 | 0,1205 | 0,0035 | 0,67 | 0,1205 | 0,0054 | 0,97 | 0,1377 | 0,0044 | 0,97 | 0,1377 | 0,0069 |
| S33- | St. Pölten Nord | St. Pölten Ost | 0,85 | 0,1521 | 0,0027 | 0,85 | 0,1521 | 0,0042 | 1,19 | 0,2130 | 0,0061 | 1,19 | 0,2130 | 0,0096 | 1,71 | 0,2434 | 0,0077 | 1,71 | 0,2434 | 0,0121 |
| S33- | Herzogenburg Süd | St. Pölten Nord | 0,90 | 0,1611 | 0,0028 | 0,90 | 0,1611 | 0,0044 | 1,26 | 0,2255 | 0,0065 | 1,26 | 0,2255 | 0,0102 | 1,81 | 0,2577 | 0,0082 | 1,81 | 0,2577 | 0,0128 |
| S33- | Herzogenburg Stadt | Herzogenburg Süd | 0,48 | 0,0860 | 0,0015 | 0,48 | 0,0860 | 0,0024 | 0,67 | 0,1204 | 0,0035 | 0,67 | 0,1204 | 0,0054 | 0,96 | 0,1376 | 0,0044 | 0,97 | 0,1376 | 0,0069 |
| S33- | Herzogenburg Nord | Herzogenburg Stadt | 0,27 | 0,0477 | 0,0008 | 0,27 | 0,0477 | 0,0013 | 0,37 | 0,0668 | 0,0019 | 0,37 | 0,0668 | 0,0030 | 0,53 | 0,0763 | 0,0024 | 0,54 | 0,0763 | 0,0038 |
| S33- | Traismauer Süd | Herzogenburg Nord | 1,29 | 0,2320 | 0,0041 | 1,30 | 0,2320 | 0,0064 | 1,81 | | | | | | | | | | | |

| | | | | | | | | | | | | | | | | | | | | |
|------|--------------------------|--------------------------|------|--------|--------|------|--------|--------|------|--------|--------|------|--------|--------|------|--------|--------|------|--------|--------|
| S36- | Zeltweg Ost Spielberg | Knittelfeld West | 0,21 | 0,0370 | 0,0006 | 0,21 | 0,0370 | 0,0010 | 0,29 | 0,0518 | 0,0015 | 0,29 | 0,0518 | 0,0023 | 0,42 | 0,0592 | 0,0019 | 0,42 | 0,0592 | 0,0030 |
| S36- | Zeltweg West | Zeltweg Ost Spielberg | 1,34 | 0,2408 | 0,0042 | 1,34 | 0,2408 | 0,0066 | 1,88 | 0,3371 | 0,0097 | 1,89 | 0,3371 | 0,0152 | 2,70 | 0,3853 | 0,0122 | 2,71 | 0,3853 | 0,0192 |
| S36- | Judenburg Ost Fohnsdorf | Zeltweg West | 0,67 | 0,1211 | 0,0021 | 0,68 | 0,1211 | 0,0033 | 0,95 | 0,1695 | 0,0049 | 0,95 | 0,1695 | 0,0077 | 1,36 | 0,1937 | 0,0061 | 1,36 | 0,1937 | 0,0097 |
| S36- | Judenburg West | Judenburg Ost Fohnsdorf | 1,05 | 0,1878 | 0,0033 | 1,05 | 0,1878 | 0,0052 | 1,47 | 0,2630 | 0,0076 | 1,47 | 0,2630 | 0,0119 | 2,11 | 0,3005 | 0,0095 | 2,11 | 0,3005 | 0,0150 |
| S36- | St. Georgen Ost | As B317 (prov.) | 0,11 | 0,0196 | 0,0003 | 0,11 | 0,0196 | 0,0005 | 0,15 | 0,0275 | 0,0008 | 0,15 | 0,0275 | 0,0012 | 0,22 | 0,0314 | 0,0010 | 0,22 | 0,0314 | 0,0016 |
| S36- | St. Georgen West | St. Georgen Ost | 0,20 | 0,0364 | 0,0006 | 0,20 | 0,0364 | 0,0010 | 0,28 | 0,0509 | 0,0015 | 0,29 | 0,0509 | 0,0023 | 0,41 | 0,0582 | 0,0018 | 0,41 | 0,0582 | 0,0029 |
| S37- | St. Veit Mitte / Brückl | St. Veit Nord | 0,63 | 0,1139 | 0,0020 | 0,64 | 0,1139 | 0,0031 | 0,89 | 0,1595 | 0,0046 | 0,89 | 0,1595 | 0,0072 | 1,28 | 0,1823 | 0,0058 | 1,28 | 0,1823 | 0,0091 |
| S37- | St. Veit Süd | St. Veit Mitte / Brückl | 0,54 | 0,0968 | 0,0017 | 0,54 | 0,0968 | 0,0027 | 0,76 | 0,1356 | 0,0039 | 0,76 | 0,1356 | 0,0061 | 1,09 | 0,1549 | 0,0049 | 1,09 | 0,1549 | 0,0077 |
| S37- | St. Veit Industriegebiet | St. Veit Süd | 0,41 | 0,0728 | 0,0013 | 0,41 | 0,0728 | 0,0020 | 0,57 | 0,1019 | 0,0029 | 0,57 | 0,1019 | 0,0046 | 0,82 | 0,1165 | 0,0037 | 0,82 | 0,1165 | 0,0058 |
| S37- | Maria Saal | St. Veit Industriegebiet | 1,42 | 0,2555 | 0,0045 | 1,43 | 0,2555 | 0,0070 | 2,00 | 0,3577 | 0,0103 | 2,00 | 0,3577 | 0,0162 | 2,87 | 0,4088 | 0,0130 | 2,87 | 0,4088 | 0,0204 |
| S37- | Karnburg | Maria Saal | 0,51 | 0,0912 | 0,0016 | 0,51 | 0,0912 | 0,0025 | 0,71 | 0,1277 | 0,0037 | 0,72 | 0,1277 | 0,0058 | 1,02 | 0,1460 | 0,0046 | 1,03 | 0,1460 | 0,0073 |
| S37- | Klagenfurt Nord | Karnburg | 0,44 | 0,0796 | 0,0014 | 0,44 | 0,0796 | 0,0022 | 0,62 | 0,1115 | 0,0032 | 0,62 | 0,1115 | 0,0050 | 0,89 | 0,1274 | 0,0040 | 0,90 | 0,1274 | 0,0064 |

| Road | Toll road section from | Toll road section to | EURO IV Cat 2 | | | | | | EURO IV Cat 3 | | | | | | EURO IV Cat 4 | | | | | |
|------|----------------------------|----------------------------|---------------|--------|--------|------------|--------|--------|---------------|--------|--------|------------|--------|--------|---------------|--------|--------|------|--------|--------|
| | | | Unit Price | | | Unit Price | | | Unit Price | | | Unit Price | | | Unit Price | | | | | |
| | | | Day | Night | | Day | Night | | Day | Night | | Day | Night | | Day | Night | | | | |
| Sum | Air | Noise | Sum | Air | Noise | Sum | Air | Noise | Sum | Air | Noise | Sum | Air | Noise | Sum | Air | Noise | | | |
| A01- | Wien Auhof | Preßbaum | 2,83 | 0,2786 | 0,0098 | 2,83 | 0,2786 | 0,0153 | 3,97 | 0,3900 | 0,0224 | 3,98 | 0,3900 | 0,0352 | 5,80 | 0,4458 | 0,0283 | 5,82 | 0,4458 | 0,0444 |
| A01- | Preßbaum | KN Steinhäusl | 1,60 | 0,1574 | 0,0055 | 1,60 | 0,1574 | 0,0087 | 2,24 | 0,2204 | 0,0127 | 2,25 | 0,2204 | 0,0199 | 3,28 | 0,2519 | 0,0160 | 3,29 | 0,2519 | 0,0251 |
| A01- | KN Steinhäusl | Altlangbach | 0,94 | 0,0926 | 0,0032 | 0,94 | 0,0926 | 0,0051 | 1,32 | 0,1296 | 0,0075 | 1,32 | 0,1296 | 0,0117 | 1,93 | 0,1481 | 0,0094 | 1,93 | 0,1481 | 0,0148 |
| A01- | Altlangbach | St. Christoph | 1,12 | 0,1104 | 0,0039 | 1,12 | 0,1104 | 0,0061 | 1,57 | 0,1545 | 0,0089 | 1,58 | 0,1545 | 0,0140 | 2,30 | 0,1766 | 0,0112 | 2,31 | 0,1766 | 0,0176 |
| A01- | St. Christoph | Böheimkirchen | 1,34 | 0,1324 | 0,0046 | 1,35 | 0,1324 | 0,0073 | 1,88 | 0,1853 | 0,0107 | 1,89 | 0,1853 | 0,0167 | 2,76 | 0,2118 | 0,0134 | 2,77 | 0,2118 | 0,0211 |
| A01- | Böheimkirchen | KN St. Pölten | 1,31 | 0,1295 | 0,0045 | 1,32 | 0,1295 | 0,0071 | 1,84 | 0,1813 | 0,0104 | 1,85 | 0,1813 | 0,0164 | 2,70 | 0,2072 | 0,0131 | 2,71 | 0,2072 | 0,0207 |
| A01- | KN St. Pölten | St. Pölten Süd | 0,93 | 0,0919 | 0,0032 | 0,93 | 0,0919 | 0,0051 | 1,31 | 0,1286 | 0,0074 | 1,31 | 0,1286 | 0,0116 | 1,91 | 0,1470 | 0,0093 | 1,92 | 0,1470 | 0,0147 |
| A01- | St. Pölten Süd | Loosdorf | 3,23 | 0,3186 | 0,0111 | 3,24 | 0,3186 | 0,0175 | 4,53 | 0,4460 | 0,0256 | 4,55 | 0,4460 | 0,0403 | 6,64 | 0,5097 | 0,0323 | 6,65 | 0,5097 | 0,0508 |
| A01- | Loosdorf | Melk | 1,18 | 0,1167 | 0,0041 | 1,19 | 0,1167 | 0,0064 | 1,66 | 0,1634 | 0,0094 | 1,67 | 0,1634 | 0,0148 | 2,43 | 0,1868 | 0,0118 | 2,44 | 0,1868 | 0,0186 |
| A01- | Melk | Pöchlarn | 2,10 | 0,2069 | 0,0072 | 2,10 | 0,2069 | 0,0114 | 2,95 | 0,2897 | 0,0167 | 2,96 | 0,2897 | 0,0262 | 4,31 | 0,3311 | 0,0210 | 4,32 | 0,3311 | 0,0330 |
| A01- | Pöchlarn | Ybbs Wieselburg | 1,94 | 0,1909 | 0,0067 | 1,94 | 0,1909 | 0,0105 | 2,72 | 0,2673 | 0,0154 | 2,73 | 0,2673 | 0,0242 | 3,98 | 0,3055 | 0,0194 | 3,99 | 0,3055 | 0,0305 |
| A01- | Ybbs Wieselburg | Amstetten Ost | 1,74 | 0,1716 | 0,0060 | 1,74 | 0,1716 | 0,0094 | 2,44 | 0,2402 | 0,0138 | 2,45 | 0,2402 | 0,0217 | 3,57 | 0,2745 | 0,0174 | 3,58 | 0,2745 | 0,0274 |
| A01- | Amstetten Ost | Amstetten West | 2,74 | 0,2699 | 0,0094 | 2,74 | 0,2699 | 0,0148 | 3,84 | 0,3778 | 0,0217 | 3,85 | 0,3778 | 0,0341 | 5,62 | 0,4318 | 0,0274 | 5,64 | 0,4318 | 0,0430 |
| A01- | Amstetten West | Oed | 1,92 | 0,1895 | 0,0066 | 1,93 | 0,1895 | 0,0104 | 2,70 | 0,2653 | 0,0153 | 2,71 | 0,2653 | 0,0240 | 3,95 | 0,3032 | 0,0192 | 3,96 | 0,3032 | 0,0302 |
| A01- | Oed | Haag | 2,07 | 0,2045 | 0,0072 | 2,08 | 0,2045 | 0,0112 | 2,91 | 0,2863 | 0,0165 | 2,92 | 0,2863 | 0,0259 | 4,26 | 0,3272 | 0,0208 | 4,27 | 0,3272 | 0,0326 |
| A01- | Haag | St. Valentin | 1,85 | 0,1821 | 0,0064 | 1,85 | 0,1821 | 0,0100 | 2,59 | 0,2549 | 0,0147 | 2,60 | 0,2549 | 0,0230 | 3,71 | 0,2849 | 0,0185 | 3,80 | 0,2914 | 0,0290 |
| A01- | St. Valentin | Enns Steyr | 0,78 | 0,0772 | 0,0027 | 0,78 | 0,0772 | 0,0042 | 1,10 | 0,1081 | 0,0062 | 1,10 | 0,1081 | 0,0098 | 1,61 | 0,1235 | 0,0078 | 1,61 | 0,1235 | 0,0123 |
| A01- | Enns Steyr | Enns West | 0,61 | 0,0599 | 0,0021 | 0,61 | 0,0599 | 0,0033 | 0,85 | 0,0838 | 0,0048 | 0,86 | 0,0838 | 0,0076 | 1,25 | 0,0958 | 0,0061 | 1,25 | 0,0958 | 0,0096 |
| A01- | Enns West | Asten St Florian | 0,47 | 0,0465 | 0,0016 | 0,47 | 0,0465 | 0,0026 | 0,66 | 0,0651 | 0,0037 | 0,66 | 0,0651 | 0,0059 | 0,97 | 0,0744 | 0,0047 | 0,97 | 0,0744 | 0,0074 |
| A01- | Asten St Florian | KN Linz | 1,81 | 0,1781 | 0,0098 | 1,81 | 0,1781 | 0,0143 | 2,54 | 0,2493 | 0,0143 | 2,54 | 0,2493 | 0,0225 | 3,71 | 0,2849 | 0,0181 | 3,72 | 0,2849 | 0,0284 |
| A01- | KN Linz | Ansfelden | 0,30 | 0,0300 | 0,0011 | 0,31 | 0,0300 | 0,0017 | 0,43 | 0,0420 | 0,0024 | 0,43 | 0,0420 | 0,0038 | 0,63 | 0,0480 | 0,0030 | 0,63 | 0,0480 | 0,0048 |
| A01- | Ansfelden | Traun | 0,67 | 0,0664 | 0,0023 | 0,68 | 0,0664 | 0,0037 | 0,95 | 0,0930 | 0,0053 | 0,95 | 0,0930 | 0,0084 | 1,38 | 0,1063 | 0,0067 | 1,39 | 0,1063 | 0,0106 |
| A01- | Traun | KN A1/A25 Passau Wels | 0,32 | 0,0312 | 0,0011 | 0,32 | 0,0312 | 0,0017 | 0,44 | 0,0437 | 0,0025 | 0,45 | 0,0437 | 0,0040 | 0,65 | 0,0500 | 0,0032 | 0,65 | 0,0500 | 0,0050 |
| A01- | KN A1/A25 Passau Wels | Allhaming | 1,46 | 0,1441 | 0,0050 | 1,47 | 0,1441 | 0,0079 | 2,05 | 0,2018 | 0,0116 | 2,06 | 0,2018 | 0,0182 | 3,00 | 0,2306 | 0,0146 | 3,01 | 0,2306 | 0,0230 |
| A01- | Allhaming | Sattledt | 2,44 | 0,2405 | 0,0084 | 2,44 | 0,2405 | 0,0132 | 3,42 | 0,3367 | 0,0194 | 3,43 | 0,3367 | 0,0304 | 5,01 | 0,3848 | 0,0244 | 5,02 | 0,3848 | 0,0384 |
| A01- | Sattledt | KN Voralpenkreuz | 0,31 | 0,0303 | 0,0011 | 0,31 | 0,0303 | 0,0017 | 0,43 | 0,0424 | 0,0024 | 0,43 | 0,0424 | 0,0038 | 0,63 | 0,0484 | 0,0031 | 0,63 | 0,0484 | 0,0048 |
| A01- | KN Voralpenkreuz | Eberstalzell | 0,88 | 0,0871 | 0,0030 | 0,89 | 0,0871 | 0,0048 | 1,24 | 0,1219 | 0,0070 | 1,24 | 0,1219 | 0,0110 | 1,81 | 0,1393 | 0,0088 | 1,82 | 0,1393 | 0,0139 |
| A01- | Eberstalzell | Vorchdorf | 1,33 | 0,1313 | 0,0046 | 1,33 | 0,1313 | 0,0072 | 1,87 | 0,1838 | 0,0106 | 1,87 | 0,1838 | 0,0166 | 2,73 | 0,2100 | 0,0133 | 2,74 | 0,2100 | 0,0209 |
| A01- | Vorchdorf | Laakirchen Ost | 1,17 | 0,1150 | 0,0040 | 1,17 | 0,1150 | 0,0063 | 1,64 | 0,1610 | 0,0093 | 1,64 | 0,1610 | 0,0146 | 2,40 | 0,1840 | 0,0117 | 2,40 | 0,1840 | 0,0183 |
| A01- | Laakirchen Ost | Laakirchen West | 0,73 | 0,0724 | 0,0025 | 0,74 | 0,0724 | 0,0040 | 1,03 | 0,1014 | 0,0058 | 1,03 | 0,1014 | 0,0092 | 1,51 | 0,1158 | 0,0073 | 1,51 | 0,1158 | 0,0115 |
| A01- | Laakirchen West | Regau | 1,44 | 0,1419 | 0,0050 | 1,44 | 0,1419 | 0,0078 | 2,02 | 0,1987 | 0,0114 | 2,03 | 0,1987 | 0,0180 | 2,96 | 0,2271 | 0,0144 | 2,96 | 0,2271 | 0,0226 |
| A01- | Regau | Schörfling | 1,89 | 0,1865 | 0,0065 | 1,90 | 0,1865 | 0,0103 | 2,65 | 0,2611 | 0,0150 | 2,66 | 0,2611 | 0,0236 | 3,88 | 0,2984 | 0,0189 | 3,90 | 0,2984 | 0,0297 |
| A01- | Schörfling | Seewalchen | 0,29 | 0,0289 | 0,0010 | 0,29 | 0,0289 | 0,0016 | 0,41 | 0,0405 | 0,0023 | 0,41 | 0,0405 | 0,0037 | 0,60 | 0,0462 | 0,0029 | 0,60 | 0,0462 | 0,0046 |
| A01- | Seewalchen | St. Georgen | 1,71 | 0,1690 | 0,0059 | 1,72 | 0,1690 | 0,0093 | 2,41 | 0,2367 | 0,0136 | 2,41 | 0,2367 | 0,0214 | 3,52 | 0,2705 | 0,0172 | 3,53 | 0,2705 | 0,0270 |
| A01- | St. Georgen | Oberwang | 2,29 | 0,2254 | 0,0079 | 2,29 | 0,2254 | 0,0124 | 3,21 | 0,3156 | 0,0181 | 3,22 | 0,3156 | 0,0285 | 4,70 | 0,3606 | 0,0229 | 4,71 | 0,3606 | 0,0360 |
| A01- | Oberwang | Mondsee | 2,10 | 0,2075 | 0,0073 | 2,11 | 0,2075 | 0,0114 | 2,95 | 0,2904 | 0,0167 | 2,96 | 0,2904 | 0,0262 | 4,32 | 0,3319 | 0,0211 | 4,33 | 0,3319 | 0,0331 |
| A01- | Mondsee | Thalgau | 1,94 | 0,1913 | 0,0067 | 1,94 | 0,1913 | 0,0105 | 2,72 | 0,2678 | 0,0154 | 2,73 | 0,2678 | 0,0242 | 3,98 | 0,3060 | 0,0194 | 4,00 | 0,3060 | 0,0305 |
| A01- | Thalgau | Wallersee | 1,48 | 0,1457 | 0,0051 | 1,48 | 0,1457 | 0,0080 | 2,07 | 0,2040 | 0,0117 | 2,08 | 0,2040 | 0,0184 | 3,04 | 0,2332 | 0,0148 | 3,04 | 0,2332 | 0,0232 |
| A01- | Wallersee | Salzburg Nord | 1,43 | 0,1411 | 0,0049 | 1,43 | 0,1411 | 0,0078 | 2,01 | 0,1975 | 0,0114 | 2,01 | 0,1975 | 0,0178 | 2,94 | 0,2257 | 0,0143 | 2,95 | 0,2257 | 0,0225 |
| A01- | Salzburg Nord | Salzburg Bergheim-West | 0,32 | 0,0318 | 0,0011 | 0,32 | 0,0318 | 0,0017 | 0,45 | 0,0445 | 0,0026 | 0,45 | 0,0445 | 0,0040 | 0,66 | 0,0509 | 0,0032 | 0,66 | 0,0509 | 0,0051 |
| A01- | Salzburg Bergheim-West | Messe | 0,15 | 0,0152 | 0,0005 | 0,15 | 0,0152 | 0,0008 | 0,22 | 0,0213 | 0,0012 | 0,22 | 0,0213 | 0,0019 | 0,32 | 0,0244 | 0,0015 | 0,32 | 0,0244 | 0,0024 |
| A01- | Messe | Salzburg Mitte Freilassing | 0,21 | 0,0203 | 0,0007 | 0,21 | 0,0203 | 0,0011 | 0,29 | 0,0284 | 0,0016 | 0,29 | 0,0284 | 0,0026 | 0,42 | 0,0324 | 0,0021 | 0,42 | 0,0324 | 0,0032 |
| A01- | Salzburg Mitte Freilassing | Kleßheim | 0,25 | 0,0249 | 0,0009 | 0,25 | 0,0249 | 0,0014 | 0,35 | 0,0348 | 0,0020 | 0,36 | 0,0348 | 0,0031 | 0,52 | 0,0398 | 0,0025 | 0,52 | 0,0398 | 0,0040 |
| A01- | Kleßheim | Siezenheim | 0,35 | 0,0345 | 0,0012 | 0,35 | 0,0345 | 0,0019 | 0,49 | 0,0482 | 0,0028 | 0,49 | 0,0482 | 0,0044 | 0,72 | 0,0551 | 0,0035 | 0,72 | 0,0551 | 0,0055 |
| A01- | Siezenheim | Flughafen | 0,18 | 0,0173 | 0,0006 | 0,18 | 0,0173 | 0,0010 | 0,25 | 0,0242 | 0,0014 | 0,25 | 0,0242 | 0,0022 | 0,36 | 0,0277 | 0,0018 | 0,36 | 0,0277 | 0,0028 |
| A01- | Flughafen | Wals Salzburg West | 0,21 | 0,0212 | 0,0007 | 0,22 | 0,0212 | 0,0012 | 0,30 | 0,0297 | 0,0017 | 0,30 | 0,0297 | 0,0027 | 0,44 | 0,0339 | 0,0021 | 0,44 | 0,0339 | 0,0034 |
| A01- | Wals Salzburg West | KN Salzburg | 0,32 | 0,0317 | 0,0011 | 0,32 | 0,0317 | 0,0017 | 0,45 | 0,0444 | 0,0026 | 0,45 | 0,0444 | 0,0040 | 0,66 | 0,0507 | 0,0032 | 0,66 | 0,0507 | 0,0051 |
| A01- | KN Salzburg | Staatsgrenze Walsberg | 0,55 | 0,0539 | 0,0019 | 0,55 | 0,0539 | 0,0030 | 0,77 | 0,0754 | 0,0043 | 0,77 | 0,0754 | 0,0068 | 1,12 | 0,0862 | 0,0055 | 1,13 | 0,0862 | 0,0086 |
| A02- | KN Wien Inzersdorf | KN Vösendorf | 0,68 | 0,0674 | 0,0024 | 0,69 | 0,0674 | 0,0037 | 0,96 | 0,0944 | 0,0054 | 0,96 | 0,0944 | 0,0085 | 1,40 | 0,1078 | 0,0068 | 1,41 | 0,1078 | 0,0108 |
| A02- | KN Vösendorf | Mödling | 0,46 | 0,0458 | 0,0016 | 0,47 | 0,0458 | 0,0025 | 0,65 | 0,0641 | 0,0037 | 0 | | | | | | | | |

| | | | | | | | | | | | | | | | | | | | | |
|------|----------------------------|----------------------------|------|--------|--------|------|--------|--------|------|--------|--------|------|--------|--------|------|--------|--------|------|--------|--------|
| A02- | Ilz Fürstenfeld | Sinabelkirchen | 2,28 | 0,2247 | 0,0079 | 2,28 | 0,2247 | 0,0124 | 3,20 | 0,3145 | 0,0181 | 3,21 | 0,3145 | 0,0284 | 4,68 | 0,3595 | 0,0228 | 4,69 | 0,3595 | 0,0358 |
| A02- | Sinabelkirchen | Gleisdorf Süd | 1,50 | 0,1480 | 0,0052 | 1,50 | 0,1480 | 0,0081 | 2,11 | 0,2072 | 0,0119 | 2,11 | 0,2072 | 0,0187 | 3,08 | 0,2368 | 0,0150 | 3,09 | 0,2368 | 0,0236 |
| A02- | Gleisdorf Süd | Gleisdorf West | 0,65 | 0,0642 | 0,0022 | 0,65 | 0,0642 | 0,0035 | 0,91 | 0,0899 | 0,0052 | 0,92 | 0,0899 | 0,0081 | 1,34 | 0,1028 | 0,0065 | 1,34 | 0,1028 | 0,0102 |
| A02- | Gleisdorf West | Laßnitzhöhe | 1,71 | 0,1683 | 0,0059 | 1,71 | 0,1683 | 0,0093 | 2,40 | 0,2356 | 0,0135 | 2,40 | 0,2356 | 0,0213 | 3,51 | 0,2693 | 0,0171 | 3,50 | 0,2693 | 0,0268 |
| A02- | Laßnitzhöhe | KN Graz Ost | 2,14 | 0,2106 | 0,0074 | 2,14 | 0,2106 | 0,0116 | 3,00 | 0,2948 | 0,0170 | 3,01 | 0,2948 | 0,0266 | 4,39 | 0,3369 | 0,0214 | 4,40 | 0,3369 | 0,0336 |
| A02- | KN Graz Ost | Graz Feldkirchen Flughafen | 0,77 | 0,0758 | 0,0027 | 0,77 | 0,0758 | 0,0042 | 1,08 | 0,1061 | 0,0061 | 1,08 | 0,1061 | 0,0096 | 1,58 | 0,1212 | 0,0077 | 1,58 | 0,1212 | 0,0121 |
| A02- | Graz Feldkirchen Flughafen | KN Graz West | 0,51 | 0,0507 | 0,0018 | 0,52 | 0,0507 | 0,0028 | 0,72 | 0,0710 | 0,0041 | 0,72 | 0,0710 | 0,0064 | 1,06 | 0,0812 | 0,0051 | 1,06 | 0,0812 | 0,0081 |
| A02- | KN Graz West | Unterpremstätten | 0,62 | 0,0610 | 0,0021 | 0,62 | 0,0610 | 0,0034 | 0,87 | 0,0854 | 0,0049 | 0,87 | 0,0854 | 0,0077 | 1,27 | 0,0976 | 0,0062 | 1,27 | 0,0976 | 0,0097 |
| A02- | Unterpremstätten | Lieboch | 0,96 | 0,0947 | 0,0033 | 0,96 | 0,0947 | 0,0052 | 1,35 | 0,1326 | 0,0076 | 1,35 | 0,1326 | 0,0120 | 1,97 | 0,1515 | 0,0096 | 1,98 | 0,1515 | 0,0151 |
| A02- | Lieboch | Mooskirchen | 1,32 | 0,1306 | 0,0046 | 1,33 | 0,1306 | 0,0072 | 1,86 | 0,1828 | 0,0105 | 1,86 | 0,1828 | 0,0165 | 2,72 | 0,2089 | 0,0133 | 2,73 | 0,2089 | 0,0208 |
| A02- | Mooskirchen | Steinberg | 1,37 | 0,1351 | 0,0047 | 1,37 | 0,1351 | 0,0074 | 1,92 | 0,1892 | 0,0109 | 1,93 | 0,1892 | 0,0171 | 2,82 | 0,2162 | 0,0137 | 2,82 | 0,2162 | 0,0216 |
| A02- | Steinberg | Modriach | 3,43 | 0,3378 | 0,0118 | 3,43 | 0,3378 | 0,0186 | 4,81 | 0,4729 | 0,0272 | 4,82 | 0,4729 | 0,0427 | 7,04 | 0,5405 | 0,0343 | 7,06 | 0,5405 | 0,0539 |
| A022 | KN Graz Ost | Puchwerk | 0,14 | 0,0142 | 0,0005 | 0,14 | 0,0142 | 0,0008 | 0,20 | 0,0198 | 0,0011 | 0,20 | 0,0198 | 0,0018 | 0,30 | 0,0227 | 0,0014 | 0,30 | 0,0227 | 0,0023 |
| A022 | Puchwerk | Graz Raaba | 0,21 | 0,0202 | 0,0007 | 0,21 | 0,0202 | 0,0011 | 0,29 | 0,0283 | 0,0016 | 0,29 | 0,0283 | 0,0026 | 0,42 | 0,0324 | 0,0021 | 0,42 | 0,0324 | 0,0032 |
| A022 | Graz Raaba | Graz Sternäckerweg | 0,30 | 0,0294 | 0,0010 | 0,30 | 0,0294 | 0,0016 | 0,42 | 0,0412 | 0,0024 | 0,42 | 0,0412 | 0,0037 | 0,61 | 0,0471 | 0,0030 | 0,61 | 0,0471 | 0,0047 |
| A02- | Modriach | Packsattel | 1,58 | 0,1556 | 0,0054 | 1,58 | 0,1556 | 0,0086 | 2,21 | 0,2178 | 0,0125 | 2,22 | 0,2178 | 0,0197 | 3,24 | 0,2489 | 0,0158 | 3,25 | 0,2489 | 0,0248 |
| A02- | Packsattel | Bad St. Leonhard | 1,92 | 0,1892 | 0,0066 | 1,92 | 0,1892 | 0,0104 | 2,69 | 0,2649 | 0,0152 | 2,70 | 0,2649 | 0,0239 | 3,94 | 0,3027 | 0,0192 | 3,95 | 0,3027 | 0,0302 |
| A02- | Bad St. Leonhard | Wolfsberg Nord | 2,26 | 0,2223 | 0,0078 | 2,26 | 0,2223 | 0,0122 | 3,16 | 0,3112 | 0,0179 | 3,17 | 0,3112 | 0,0281 | 4,63 | 0,3557 | 0,0226 | 4,64 | 0,3557 | 0,0355 |
| A02- | Wolfsberg Nord | Wolfsberg Süd | 0,64 | 0,0632 | 0,0022 | 0,64 | 0,0632 | 0,0035 | 0,90 | 0,0885 | 0,0051 | 0,90 | 0,0885 | 0,0080 | 1,32 | 0,1011 | 0,0064 | 1,32 | 0,1011 | 0,0101 |
| A02- | Wolfsberg Süd | St. Andrä | 1,88 | 0,1857 | 0,0065 | 1,89 | 0,1857 | 0,0102 | 2,64 | 0,2600 | 0,0149 | 2,65 | 0,2600 | 0,0235 | 3,87 | 0,2971 | 0,0188 | 3,88 | 0,2971 | 0,0296 |
| A02- | St. Andrä | Griffen | 1,83 | 0,1805 | 0,0063 | 1,83 | 0,1805 | 0,0099 | 2,57 | 0,2527 | 0,0145 | 2,58 | 0,2527 | 0,0228 | 3,76 | 0,2888 | 0,0183 | 3,77 | 0,2888 | 0,0288 |
| A02- | Griffen | Völkermarkt Ost | 0,93 | 0,0912 | 0,0032 | 0,93 | 0,0912 | 0,0050 | 1,30 | 0,1277 | 0,0073 | 1,30 | 0,1277 | 0,0115 | 1,90 | 0,1459 | 0,0093 | 1,90 | 0,1459 | 0,0145 |
| A02- | Völkermarkt Ost | Völkermarkt West | 2,13 | 0,2104 | 0,0074 | 2,14 | 0,2104 | 0,0116 | 3,00 | 0,2946 | 0,0169 | 3,00 | 0,2946 | 0,0266 | 4,38 | 0,3367 | 0,0214 | 4,40 | 0,3367 | 0,0336 |
| A02- | Völkermarkt West | Ferlach | 2,04 | 0,2014 | 0,0070 | 2,05 | 0,2014 | 0,0111 | 2,87 | 0,2820 | 0,0162 | 2,88 | 0,2820 | 0,0255 | 4,20 | 0,3223 | 0,0204 | 4,21 | 0,3223 | 0,0321 |
| A02- | Ferlach | Klagenfurt Ost | 1,31 | 0,1292 | 0,0045 | 1,31 | 0,1292 | 0,0071 | 1,84 | 0,1809 | 0,0104 | 1,85 | 0,1809 | 0,0163 | 2,69 | 0,2067 | 0,0131 | 2,70 | 0,2067 | 0,0206 |
| A02- | Klagenfurt Ost | Klagenfurt Flughafen | 0,66 | 0,0654 | 0,0023 | 0,66 | 0,0654 | 0,0036 | 0,93 | 0,0915 | 0,0053 | 0,93 | 0,0915 | 0,0083 | 1,36 | 0,1046 | 0,0066 | 1,37 | 0,1046 | 0,0104 |
| A02- | Klagenfurt Flughafen | Klagenfurt Nord | 0,73 | 0,0724 | 0,0025 | 0,74 | 0,0724 | 0,0040 | 1,03 | 0,1014 | 0,0058 | 1,03 | 0,1014 | 0,0092 | 1,51 | 0,1158 | 0,0073 | 1,51 | 0,1158 | 0,0115 |
| A02- | Klagenfurt Nord | Klagenfurt West | 1,27 | 0,1252 | 0,0044 | 1,27 | 0,1252 | 0,0069 | 1,78 | 0,1753 | 0,0101 | 1,79 | 0,1753 | 0,0158 | 2,61 | 0,2003 | 0,0127 | 2,62 | 0,2003 | 0,0200 |
| A02- | Klagenfurt West | Krumpendorf West | 0,51 | 0,0499 | 0,0017 | 0,51 | 0,0499 | 0,0027 | 0,71 | 0,0699 | 0,0040 | 0,71 | 0,0699 | 0,0063 | 1,04 | 0,0798 | 0,0051 | 1,04 | 0,0798 | 0,0080 |
| A02- | Krumpendorf West | Pörschach Ost | 0,61 | 0,0601 | 0,0021 | 0,61 | 0,0601 | 0,0033 | 0,86 | 0,0841 | 0,0048 | 0,86 | 0,0841 | 0,0076 | 1,25 | 0,0962 | 0,0061 | 1,26 | 0,0962 | 0,0096 |
| A02- | Pörschach Ost | Pörschach West | 0,95 | 0,0936 | 0,0033 | 0,95 | 0,0936 | 0,0051 | 1,33 | 0,1310 | 0,0075 | 1,34 | 0,1310 | 0,0118 | 1,95 | 0,1497 | 0,0095 | 1,95 | 0,1497 | 0,0149 |
| A02- | Pörschach West | Velden Ost | 0,70 | 0,0693 | 0,0024 | 0,70 | 0,0693 | 0,0038 | 0,99 | 0,0971 | 0,0056 | 0,99 | 0,0971 | 0,0088 | 1,44 | 0,1109 | 0,0070 | 1,45 | 0,1109 | 0,0111 |
| A02- | Velden Ost | Velden West | 0,76 | 0,0747 | 0,0026 | 0,76 | 0,0747 | 0,0041 | 1,06 | 0,1045 | 0,0060 | 1,07 | 0,1045 | 0,0094 | 1,56 | 0,1195 | 0,0076 | 1,56 | 0,1195 | 0,0119 |
| A02- | Velden West | Wernberg | 1,25 | 0,1234 | 0,0043 | 1,25 | 0,1234 | 0,0068 | 1,76 | 0,1728 | 0,0099 | 1,76 | 0,1728 | 0,0156 | 2,57 | 0,1974 | 0,0125 | 2,58 | 0,1974 | 0,0197 |
| A02- | Wernberg | KN Villach | 0,67 | 0,0656 | 0,0023 | 0,67 | 0,0656 | 0,0036 | 0,93 | 0,0918 | 0,0053 | 0,94 | 0,0918 | 0,0083 | 1,37 | 0,1050 | 0,0067 | 1,37 | 0,1050 | 0,0105 |
| A02- | KN Villach | Villach Faaker See | 0,52 | 0,0510 | 0,0018 | 0,52 | 0,0510 | 0,0028 | 0,73 | 0,0714 | 0,0041 | 0,73 | 0,0714 | 0,0065 | 1,06 | 0,0816 | 0,0052 | 1,07 | 0,0816 | 0,0081 |
| A02- | Villach Faaker See | Villach Warmbad | 1,18 | 0,1165 | 0,0041 | 1,18 | 0,1165 | 0,0064 | 1,66 | 0,1631 | 0,0094 | 1,66 | 0,1631 | 0,0147 | 2,43 | 0,1864 | 0,0118 | 2,43 | 0,1864 | 0,0186 |
| A02- | Villach Warmbad | Hermagor | 2,14 | 0,2112 | 0,0074 | 2,15 | 0,2112 | 0,0116 | 3,01 | 0,2957 | 0,0170 | 3,02 | 0,2957 | 0,0267 | 4,40 | 0,3379 | 0,0214 | 4,41 | 0,3379 | 0,0337 |
| A02- | Hermagor | Arnoldstein | 0,51 | 0,0503 | 0,0018 | 0,51 | 0,0503 | 0,0028 | 0,72 | 0,0704 | 0,0040 | 0,72 | 0,0704 | 0,0064 | 1,05 | 0,0805 | 0,0051 | 1,05 | 0,0805 | 0,0080 |
| A02- | Arnoldstein | Staatsgrenze Arnoldstein | 0,78 | 0,0771 | 0,0027 | 0,78 | 0,0771 | 0,0042 | 1,10 | 0,1080 | 0,0062 | 1,10 | 0,1080 | 0,0098 | 1,61 | 0,1234 | 0,0078 | 1,61 | 0,1234 | 0,0123 |
| A03- | KN Guntramsdorf | Münchendorf/Achau | 0,20 | 0,0200 | 0,0007 | 0,20 | 0,0200 | 0,0011 | 0,28 | 0,0280 | 0,0016 | 0,29 | 0,0280 | 0,0025 | 0,42 | 0,0320 | 0,0020 | 0,42 | 0,0320 | 0,0032 |
| A03- | Münchendorf/Achau | Ebreichsdorf Nord | 0,86 | 0,0843 | 0,0029 | 0,86 | 0,0843 | 0,0046 | 1,20 | 0,1180 | 0,0068 | 1,20 | 0,1180 | 0,0107 | 1,76 | 0,1348 | 0,0086 | 1,76 | 0,1348 | 0,0134 |
| A03- | Ebreichsdorf Nord | Ebreichsdorf West | 0,70 | 0,0688 | 0,0024 | 0,70 | 0,0688 | 0,0038 | 0,98 | 0,0963 | 0,0055 | 0,98 | 0,0963 | 0,0087 | 1,43 | 0,1101 | 0,0070 | 1,44 | 0,1101 | 0,0110 |
| A03- | Ebreichsdorf West | Pottendorf | 0,92 | 0,0903 | 0,0032 | 0,92 | 0,0903 | 0,0050 | 1,28 | 0,1264 | 0,0073 | 1,29 | 0,1264 | 0,0114 | 1,88 | 0,1444 | 0,0092 | 1,89 | 0,1444 | 0,0144 |
| A03- | Pottendorf | Hornstein | 1,50 | 0,1482 | 0,0052 | 1,51 | 0,1482 | 0,0082 | 2,11 | 0,2075 | 0,0119 | 2,12 | 0,2075 | 0,0187 | 3,09 | 0,2371 | 0,0150 | 3,10 | 0,2371 | 0,0236 |
| A03- | Hornstein | Müllendorf | 0,99 | 0,0971 | 0,0034 | 0,99 | 0,0971 | 0,0053 | 1,38 | 0,1360 | 0,0078 | 1,39 | 0,1360 | 0,0123 | 2,02 | 0,1554 | 0,0099 | 2,03 | 0,1554 | 0,0155 |
| A03- | Müllendorf | KN Eisenstadt | 0,82 | 0,0812 | 0,0028 | 0,83 | 0,0812 | 0,0045 | 1,16 | 0,1137 | 0,0065 | 1,16 | 0,1137 | 0,0103 | 1,69 | 0,1299 | 0,0082 | 1,70 | 0,1299 | 0,0129 |
| A031 | KN Eisenstadt | Siegersdorf | 0,65 | 0,0640 | 0,0022 | 0,65 | 0,0640 | 0,0035 | 0,91 | 0,0896 | 0,0052 | 0,91 | 0,0896 | 0,0081 | 1,33 | 0,1024 | 0,0065 | 1,34 | 0,1024 | 0,0102 |
| A041 | Stadionbrücke | KN Wien Prater | 0,12 | 0,0118 | 0,0004 | 0,12 | 0,0118 | 0,0006 | 0,17 | 0,0165 | 0,0009 | 0,17 | 0,0165 | 0,0015 | 0,25 | 0,0188 | 0,0012 | 0,25 | 0,0188 | 0,0019 |
| A04- | KN Wien Prater | Alt-Simmering | 0,26 | 0,0256 | 0,0009 | 0,26 | 0,0256 | 0,0014 | 0,36 | 0,0359 | 0,0021 | 0,37 | 0,0359 | 0,0032 | 0,53 | 0,0410 | 0,0026 | 0,54 | 0,0410 | 0,0041 |
| A04- | Alt-Simmering | Wien 7. Haidequerstraße | 0,20 | 0,0193 | 0,0007 | 0,20 | 0,0193 | 0,0011 | 0,28 | 0,0271 | 0,0016 | 0,28 | 0,0271 | 0,0024 | 0,40 | 0,0309 | 0,0020 | 0,40 | 0,0309 | 0,0031 |
| A04- | Wien 7. Haidequerstraße | Wien Simmeringer Haide | 0,37 | 0,0361 | 0,0013 | 0,37 | 0,0361 | 0,0020 | 0,51 | 0,0506 | 0,0029 | 0,52 | 0,0506 | 0,0046 | 0,75 | 0,0578 | 0,0037 | 0,76 | 0,0578 | 0,0058 |
| A04- | Wien Simmeringer Haide | KN Schwechat | 0,74 | 0,0728 | 0,0025 | 0,74 | 0,0728 | 0,0040 | 1,04 | 0,1019 | 0,0059 | 1,04 | 0,1019 | 0,0092 | 1,52 | 0,1165 | 0,0074 | 1,52 | 0,1165 | 0,0116 |
| A04- | KN Schwechat | Flughafen Wien Schwechat | 1,07 | 0,1052 | 0,0037 | 1,07 | 0,1052 | 0,0058 | 1,50 | 0,1472 | 0,0085 | 1,50 | 0,1472 | 0,0133 | 2,19 | 0,1683 | 0,0107 | 2,20 | 0,1683 | 0,0168 |
| A04- | Flughafen Wien Schwechat | Fischamend | 1,19 | 0,1177 | 0,0041 | 1,20 | 0,1177 | 0,0065 | 1,68 | 0,1648 | 0,0095 | 1,68 | 0,1648 | 0,0149 | 2,45 | 0,1884 | 0,0120 | 2,46 | 0,1884 | 0,0188 |
| A04- | Fischamend | Bruck/Leitha West | 2,62 | 0,2582 | 0,0090 | 2,62 | 0,2582 | 0,0142 | 3,68 | 0,3615 | 0,0208 | 3,69 | 0,3615 | 0,0327 | 5,38 | 0,4132 | 0,0262 | 5,39 | 0,4132 | 0,0412 |
| A04- | Bruck/Leitha West | Bruck/Leitha Ost | 0,87 | 0,0858 | 0,0030 | 0,87 | 0,0858 | 0,0047 | 1,22 | 0,1201 | 0,0069 | | | | | | | | | |

| | | | | | | | | | | | | | | | | | | | | |
|------|----------------------------------|----------------------------------|-------|--------|--------|-------|--------|--------|-------|--------|--------|-------|--------|--------|-------|--------|--------|-------|--------|--------|
| A05- | Großkrut | Poysdorf Nord | 1,39 | 0,1371 | 0,0048 | 1,39 | 0,1371 | 0,0075 | 1,95 | 0,1919 | 0,0110 | 1,96 | 0,1919 | 0,0173 | 2,86 | 0,2193 | 0,0139 | 2,86 | 0,2193 | 0,0219 |
| A06- | KN Bruckneudorf | Potzneusiedl | 1,76 | 0,1736 | 0,0061 | 1,76 | 0,1736 | 0,0095 | 2,47 | 0,2431 | 0,0140 | 2,48 | 0,2431 | 0,0220 | 3,62 | 0,2778 | 0,0176 | 3,63 | 0,2778 | 0,0277 |
| A06- | Potzneusiedl | Gattendorf | 0,76 | 0,0754 | 0,0026 | 0,77 | 0,0754 | 0,0041 | 1,07 | 0,1055 | 0,0061 | 1,08 | 0,1055 | 0,0095 | 1,57 | 0,1206 | 0,0076 | 1,57 | 0,1206 | 0,0120 |
| A06- | Gattendorf | Kittsee | 1,28 | 0,1260 | 0,0044 | 1,28 | 0,1260 | 0,0069 | 1,79 | 0,1765 | 0,0101 | 1,80 | 0,1765 | 0,0159 | 2,63 | 0,2017 | 0,0128 | 2,63 | 0,2017 | 0,0201 |
| A06- | Kittsee | Staatsgrenze Kittsee | 0,65 | 0,0640 | 0,0022 | 0,65 | 0,0640 | 0,0035 | 0,91 | 0,0896 | 0,0052 | 0,91 | 0,0896 | 0,0081 | 1,33 | 0,1024 | 0,0065 | 1,34 | 0,1024 | 0,0102 |
| A07- | KN Linz | Linz Franzosenhausweg | 0,46 | 0,0452 | 0,0016 | 0,46 | 0,0452 | 0,0025 | 0,64 | 0,0632 | 0,0036 | 0,64 | 0,0632 | 0,0057 | 0,94 | 0,0723 | 0,0046 | 0,94 | 0,0723 | 0,0072 |
| A07- | Linz Franzosenhausweg | Linz Salzburger Straße Neue Welt | 0,40 | 0,0394 | 0,0014 | 0,40 | 0,0394 | 0,0022 | 0,56 | 0,0552 | 0,0032 | 0,56 | 0,0552 | 0,0050 | 0,82 | 0,0631 | 0,0040 | 0,82 | 0,0631 | 0,0063 |
| A07- | Linz Salzburger Straße Neue Welt | Muldenstraße Bindermichl | 0,28 | 0,0274 | 0,0010 | 0,28 | 0,0274 | 0,0015 | 0,39 | 0,0383 | 0,0022 | 0,39 | 0,0383 | 0,0035 | 0,57 | 0,0438 | 0,0028 | 0,57 | 0,0438 | 0,0044 |
| A07- | Muldenstraße Bindermichl | Leonding Linz Zentrum | 0,13 | 0,0133 | 0,0005 | 0,14 | 0,0133 | 0,0007 | 0,19 | 0,0186 | 0,0011 | 0,19 | 0,0186 | 0,0017 | 0,28 | 0,0212 | 0,0013 | 0,28 | 0,0212 | 0,0021 |
| A07- | Leonding Linz Zentrum | Linz Wiener Straße | 0,19 | 0,0187 | 0,0007 | 0,19 | 0,0187 | 0,0010 | 0,27 | 0,0262 | 0,0015 | 0,27 | 0,0262 | 0,0024 | 0,39 | 0,0299 | 0,0019 | 0,39 | 0,0299 | 0,0030 |
| A07- | Linz Wiener Straße | Linz VOEST | 0,18 | 0,0174 | 0,0006 | 0,18 | 0,0174 | 0,0010 | 0,25 | 0,0243 | 0,0014 | 0,25 | 0,0243 | 0,0022 | 0,36 | 0,0278 | 0,0018 | 0,36 | 0,0278 | 0,0028 |
| A07- | Linz VOEST | Linz Industriezeile | 0,14 | 0,0136 | 0,0005 | 0,14 | 0,0136 | 0,0007 | 0,19 | 0,0191 | 0,0011 | 0,19 | 0,0191 | 0,0017 | 0,28 | 0,0218 | 0,0014 | 0,28 | 0,0218 | 0,0022 |
| A07- | Linz Industriezeile | Linz Prinz Eugenstraße | 0,22 | 0,0216 | 0,0008 | 0,22 | 0,0216 | 0,0012 | 0,31 | 0,0303 | 0,0017 | 0,31 | 0,0303 | 0,0027 | 0,45 | 0,0346 | 0,0022 | 0,45 | 0,0346 | 0,0034 |
| A07- | Linz Prinz Eugenstraße | Linz Hafenstraße | 0,41 | 0,0405 | 0,0014 | 0,41 | 0,0405 | 0,0022 | 0,58 | 0,0566 | 0,0033 | 0,58 | 0,0566 | 0,0051 | 0,84 | 0,0647 | 0,0041 | 0,85 | 0,0647 | 0,0065 |
| A07- | Linz Hafenstraße | Linz Urfaß | 0,16 | 0,0159 | 0,0006 | 0,16 | 0,0159 | 0,0009 | 0,23 | 0,0223 | 0,0013 | 0,23 | 0,0223 | 0,0020 | 0,33 | 0,0254 | 0,0016 | 0,33 | 0,0254 | 0,0025 |
| A07- | Linz Urfaß | Linz Dornach | 0,39 | 0,0385 | 0,0013 | 0,39 | 0,0385 | 0,0021 | 0,55 | 0,0539 | 0,0031 | 0,55 | 0,0539 | 0,0049 | 0,80 | 0,0616 | 0,0039 | 0,80 | 0,0616 | 0,0061 |
| A07- | Linz Dornach | Treffling | 0,86 | 0,0847 | 0,0030 | 0,86 | 0,0847 | 0,0047 | 1,21 | 0,1186 | 0,0068 | 1,21 | 0,1186 | 0,0107 | 1,76 | 0,1355 | 0,0086 | 1,77 | 0,1355 | 0,0135 |
| A07- | Treffling | Gallneukirchen | 0,65 | 0,0638 | 0,0022 | 0,65 | 0,0638 | 0,0035 | 0,91 | 0,0893 | 0,0051 | 0,91 | 0,0893 | 0,0081 | 1,33 | 0,1021 | 0,0065 | 1,33 | 0,1021 | 0,0102 |
| A07- | Gallneukirchen | Engerwitzdorf | 0,58 | 0,0568 | 0,0020 | 0,58 | 0,0568 | 0,0031 | 0,81 | 0,0796 | 0,0046 | 0,81 | 0,0796 | 0,0072 | 1,18 | 0,0909 | 0,0058 | 1,19 | 0,0909 | 0,0091 |
| A07- | Engerwitzdorf | Unterweikersdorf | 0,74 | 0,0729 | 0,0026 | 0,74 | 0,0729 | 0,0040 | 1,04 | 0,1020 | 0,0059 | 1,04 | 0,1020 | 0,0092 | 1,52 | 0,1166 | 0,0074 | 1,52 | 0,1166 | 0,0116 |
| A08- | KN Voralpenkreuz | Wels West | 2,27 | 0,2236 | 0,0078 | 2,27 | 0,2236 | 0,0123 | 3,18 | 0,3130 | 0,0180 | 3,19 | 0,3130 | 0,0283 | 4,66 | 0,3577 | 0,0227 | 4,67 | 0,3577 | 0,0357 |
| A08- | Wels West | KN Wels | 0,80 | 0,0788 | 0,0028 | 0,80 | 0,0788 | 0,0043 | 1,12 | 0,1104 | 0,0063 | 1,13 | 0,1104 | 0,0100 | 1,64 | 0,1261 | 0,0080 | 1,65 | 0,1261 | 0,0126 |
| A08- | KN Wels | Pichl/Bad Schallerbach | 0,88 | 0,0868 | 0,0030 | 0,88 | 0,0868 | 0,0048 | 1,24 | 0,1215 | 0,0070 | 1,24 | 0,1215 | 0,0110 | 1,81 | 0,1388 | 0,0088 | 1,81 | 0,1388 | 0,0138 |
| A08- | Pichl/Bad Schallerbach | Meggenhofen Gallsbach | 2,22 | 0,2192 | 0,0077 | 2,23 | 0,2192 | 0,0121 | 3,12 | 0,3069 | 0,0176 | 3,13 | 0,3069 | 0,0277 | 4,57 | 0,3508 | 0,0223 | 4,58 | 0,3508 | 0,0350 |
| A08- | Meggenhofen Gallsbach | Haag am Hausruck | 2,42 | 0,2389 | 0,0084 | 2,43 | 0,2389 | 0,0131 | 3,40 | 0,3345 | 0,0192 | 3,41 | 0,3345 | 0,0302 | 4,98 | 0,3823 | 0,0243 | 4,99 | 0,3823 | 0,0381 |
| A08- | Haag am Hausruck | Ried im Innkreis | 2,21 | 0,2180 | 0,0076 | 2,22 | 0,2180 | 0,0120 | 3,10 | 0,3053 | 0,0176 | 3,11 | 0,3053 | 0,0276 | 4,54 | 0,3489 | 0,0221 | 4,56 | 0,3489 | 0,0348 |
| A08- | Ried im Innkreis | Ort im Innkreis | 2,37 | 0,2340 | 0,0082 | 2,38 | 0,2340 | 0,0129 | 3,33 | 0,3276 | 0,0188 | 3,34 | 0,3276 | 0,0296 | 4,88 | 0,3744 | 0,0238 | 4,89 | 0,3744 | 0,0373 |
| A08- | Ort im Innkreis | Schärding Suben | 1,79 | 0,1766 | 0,0062 | 1,80 | 0,1766 | 0,0097 | 2,51 | 0,2473 | 0,0142 | 2,52 | 0,2473 | 0,0223 | 3,68 | 0,2826 | 0,0179 | 3,69 | 0,2826 | 0,0282 |
| A08- | Schärding Suben | Staatsgrenze Suben | 0,45 | 0,0446 | 0,0016 | 0,45 | 0,0446 | 0,0025 | 0,64 | 0,0625 | 0,0036 | 0,64 | 0,0625 | 0,0056 | 0,93 | 0,0714 | 0,0045 | 0,93 | 0,0714 | 0,0071 |
| A09- | KN Voralpenkreuz | Ried im Traunkreis | 1,12 | 0,1100 | 0,0039 | 1,12 | 0,1100 | 0,0061 | 1,57 | 0,1540 | 0,0089 | 1,57 | 0,1540 | 0,0139 | 2,29 | 0,1760 | 0,0112 | 2,30 | 0,1760 | 0,0175 |
| A09- | Ried im Traunkreis | Inzersdorf Kirchdorf | 2,09 | 0,2064 | 0,0072 | 2,10 | 0,2064 | 0,0114 | 2,94 | 0,2889 | 0,0166 | 2,95 | 0,2889 | 0,0261 | 4,30 | 0,3302 | 0,0209 | 4,31 | 0,3302 | 0,0329 |
| A09- | Inzersdorf Kirchdorf | Klaus | 2,55 | 0,2514 | 0,0088 | 2,56 | 0,2514 | 0,0138 | 3,58 | 0,3520 | 0,0202 | 3,59 | 0,3520 | 0,0318 | 5,24 | 0,4022 | 0,0255 | 5,25 | 0,4022 | 0,0401 |
| A09- | Klaus | St. Pankratz | 1,62 | 0,1598 | 0,0056 | 1,62 | 0,1598 | 0,0088 | 2,27 | 0,2237 | 0,0129 | 2,28 | 0,2237 | 0,0202 | 3,33 | 0,2557 | 0,0162 | 3,34 | 0,2557 | 0,0255 |
| A09- | St. Pankratz | Roßleiten Windischgarsten | 2,26 | 0,2230 | 0,0078 | 2,27 | 0,2230 | 0,0123 | 3,17 | 0,3121 | 0,0179 | 3,18 | 0,3121 | 0,0282 | 4,64 | 0,3567 | 0,0226 | 4,66 | 0,3567 | 0,0356 |
| A09- | Roßleiten Windischgarsten | Gleinkerau | 1,06 | 0,1048 | 0,0037 | 1,07 | 0,1048 | 0,0058 | 1,49 | 0,1467 | 0,0084 | 1,50 | 0,1467 | 0,0133 | 2,18 | 0,1677 | 0,0106 | 2,19 | 0,1677 | 0,0167 |
| A09- | Gleinkerau | Spital am Pyhrn | 0,80 | 0,0790 | 0,0028 | 0,80 | 0,0790 | 0,0043 | 1,12 | 0,1106 | 0,0064 | 1,13 | 0,1106 | 0,0100 | 1,65 | 0,1264 | 0,0080 | 1,65 | 0,1264 | 0,0126 |
| A09- | Spital am Pyhrn | Ardning / Admont | 4,33 | 0,2011 | 0,0070 | 4,34 | 0,2011 | 0,0111 | 6,07 | 0,2816 | 0,0162 | 6,08 | 0,2816 | 0,0254 | 9,00 | 0,3218 | 0,0204 | 9,02 | 0,3218 | 0,0321 |
| A09- | Ardning / Admont | Liezen | 0,47 | 0,0458 | 0,0016 | 0,47 | 0,0458 | 0,0025 | 0,65 | 0,0642 | 0,0037 | 0,65 | 0,0642 | 0,0058 | 0,96 | 0,0733 | 0,0047 | 0,96 | 0,0733 | 0,0073 |
| A09- | Liezen | Rottenmann | 0,97 | 0,0958 | 0,0034 | 0,97 | 0,0958 | 0,0053 | 1,36 | 0,1341 | 0,0077 | 1,37 | 0,1341 | 0,0121 | 2,00 | 0,1532 | 0,0097 | 2,00 | 0,1532 | 0,0153 |
| A09- | Rottenmann | Trieben | 2,42 | 0,2388 | 0,0084 | 2,43 | 0,2388 | 0,0131 | 3,40 | 0,3343 | 0,0192 | 3,41 | 0,3343 | 0,0302 | 4,97 | 0,3820 | 0,0242 | 4,99 | 0,3820 | 0,0381 |
| A09- | Trieben | Treglwang | 1,97 | 0,1941 | 0,0068 | 1,97 | 0,1941 | 0,0107 | 2,76 | 0,2718 | 0,0156 | 2,77 | 0,2718 | 0,0246 | 4,04 | 0,3106 | 0,0197 | 4,06 | 0,3106 | 0,0310 |
| A09- | Treglwang | Kalwang | 2,65 | 0,2609 | 0,0091 | 2,65 | 0,2609 | 0,0143 | 3,71 | 0,3653 | 0,0210 | 3,73 | 0,3653 | 0,0330 | 5,44 | 0,4174 | 0,0265 | 5,45 | 0,4174 | 0,0416 |
| A09- | Kalwang | Mautern | 1,23 | 0,1215 | 0,0043 | 1,23 | 0,1215 | 0,0067 | 1,73 | 0,1701 | 0,0098 | 1,73 | 0,1701 | 0,0154 | 2,53 | 0,1944 | 0,0123 | 2,54 | 0,1944 | 0,0194 |
| A09- | Mautern | Kammern | 1,39 | 0,1367 | 0,0048 | 1,39 | 0,1367 | 0,0075 | 1,95 | 0,1913 | 0,0110 | 1,95 | 0,1913 | 0,0173 | 2,85 | 0,2187 | 0,0139 | 2,85 | 0,2187 | 0,0218 |
| A09- | Kammern | Traboch | 1,45 | 0,1429 | 0,0050 | 1,45 | 0,1429 | 0,0079 | 2,03 | 0,2000 | 0,0115 | 2,04 | 0,2000 | 0,0181 | 2,98 | 0,2286 | 0,0145 | 2,98 | 0,2286 | 0,0228 |
| A09- | Traboch | Terminal St. Michael | 0,28 | 0,0281 | 0,0010 | 0,29 | 0,0281 | 0,0015 | 0,40 | 0,0393 | 0,0023 | 0,40 | 0,0393 | 0,0035 | 0,58 | 0,0449 | 0,0028 | 0,59 | 0,0449 | 0,0045 |
| A09- | Terminal St. Michael | KN St. Michael | 0,53 | 0,0526 | 0,0018 | 0,53 | 0,0526 | 0,0029 | 0,75 | 0,0736 | 0,0042 | 0,75 | 0,0736 | 0,0067 | 1,10 | 0,0842 | 0,0053 | 1,10 | 0,0842 | 0,0084 |
| A09- | KN St. Michael | Übelbach | 10,55 | 0,4899 | 0,0171 | 10,56 | 0,4899 | 0,0269 | 14,79 | 0,6858 | 0,0394 | 14,81 | 0,6858 | 0,0620 | 21,93 | 0,7838 | 0,0497 | 21,96 | 0,7838 | 0,0781 |
| A09- | Übelbach | KN Peggau Deutschfeistritz | 1,64 | 0,1620 | 0,0057 | 1,65 | 0,1620 | 0,0089 | 2,31 | 0,2268 | 0,0130 | 2,31 | 0,2268 | 0,0205 | 3,38 | 0,2592 | 0,0164 | 3,38 | 0,2592 | 0,0258 |
| A09- | KN Peggau Deutschfeistritz | Gratkorn Nord | 0,78 | 0,0768 | 0,0027 | 0,78 | 0,0768 | 0,0042 | 1,09 | 0,1075 | 0,0062 | 1,10 | 0,1075 | 0,0097 | 1,60 | 0,1228 | 0,0078 | 1,60 | 0,1228 | 0,0122 |
| A09- | Gratkorn Nord | Gratkorn Süd | 0,86 | 0,0843 | 0,0030 | 0,86 | 0,0843 | 0,0046 | 1,20 | 0,1180 | 0,0068 | 1,20 | 0,1180 | 0,0107 | 1,76 | 0,1349 | 0,0086 | 1,76 | 0,1349 | 0, |

| | | | | | | | | | | | | | | | | | | | | |
|------|--|---|-------|--------|--------|-------|--------|--------|-------|--------|--------|-------|--------|--------|-------|--------|--------|-------|--------|--------|
| A10- | Hallein | Kuchl | 1,19 | 0,1171 | 0,0041 | 1,19 | 0,1171 | 0,0064 | 1,67 | 0,1639 | 0,0094 | 1,67 | 0,1639 | 0,0148 | 2,44 | 0,1873 | 0,0119 | 2,45 | 0,1873 | 0,0187 |
| A10- | Kuchl | Golling / Abtenau | 1,19 | 0,1177 | 0,0041 | 1,20 | 0,1177 | 0,0065 | 1,68 | 0,1648 | 0,0095 | 1,68 | 0,1648 | 0,0149 | 2,45 | 0,1883 | 0,0119 | 2,46 | 0,1883 | 0,0188 |
| A10- | Golling / Abtenau | Paß Lueg | 1,25 | 0,1228 | 0,0043 | 1,25 | 0,1228 | 0,0068 | 1,75 | 0,1719 | 0,0099 | 1,75 | 0,1719 | 0,0155 | 2,56 | 0,1965 | 0,0125 | 2,57 | 0,1965 | 0,0196 |
| A10- | Paß Lueg | Werfen | 1,77 | 0,1749 | 0,0061 | 1,78 | 0,1749 | 0,0096 | 2,49 | 0,2449 | 0,0141 | 2,50 | 0,2449 | 0,0221 | 3,64 | 0,2799 | 0,0178 | 3,65 | 0,2799 | 0,0279 |
| A10- | Werfen | Pfarrwerfen / Werfen | 0,23 | 0,0228 | 0,0008 | 0,23 | 0,0228 | 0,0013 | 0,32 | 0,0319 | 0,0018 | 0,33 | 0,0319 | 0,0029 | 0,48 | 0,0365 | 0,0028 | 0,48 | 0,0365 | 0,0036 |
| A10- | Pfarrwerfen / Werfen | KN Pongau | 0,50 | 0,0495 | 0,0017 | 0,50 | 0,0495 | 0,0027 | 0,70 | 0,0693 | 0,0040 | 0,71 | 0,0693 | 0,0063 | 1,03 | 0,0792 | 0,0050 | 1,03 | 0,0792 | 0,0079 |
| A101 | KN Pongau | Bischofshofen Mühlbach a. Hochkönig | 0,75 | 0,0736 | 0,0026 | 0,75 | 0,0736 | 0,0040 | 1,05 | 0,1030 | 0,0059 | 1,05 | 0,1030 | 0,0093 | 1,53 | 0,1178 | 0,0075 | 1,54 | 0,1178 | 0,0117 |
| A10- | KN Pongau | Lammertal Hütttau | 2,04 | 0,2013 | 0,0070 | 2,05 | 0,2013 | 0,0111 | 2,86 | 0,2818 | 0,0162 | 2,87 | 0,2818 | 0,0255 | 4,19 | 0,3220 | 0,0204 | 4,20 | 0,3220 | 0,0321 |
| A10- | Lammertal Hütttau | F. Verbindung GH Eben | 0,53 | 0,0518 | 0,0018 | 0,53 | 0,0518 | 0,0028 | 0,74 | 0,0725 | 0,0042 | 0,74 | 0,0725 | 0,0066 | 1,08 | 0,0829 | 0,0053 | 1,08 | 0,0829 | 0,0083 |
| A10- | F. Verbindung GH Eben | Eben | 0,24 | 0,0240 | 0,0008 | 0,24 | 0,0240 | 0,0013 | 0,34 | 0,0336 | 0,0019 | 0,34 | 0,0336 | 0,0030 | 0,50 | 0,0384 | 0,0024 | 0,50 | 0,0384 | 0,0038 |
| A10- | Eben | Radstadt Altenmarkt Graz | 0,54 | 0,0533 | 0,0019 | 0,54 | 0,0533 | 0,0029 | 0,76 | 0,0746 | 0,0043 | 0,76 | 0,0746 | 0,0067 | 1,11 | 0,0853 | 0,0054 | 1,11 | 0,0853 | 0,0085 |
| A10- | Radstadt Altenmarkt Graz | Flachau | 0,76 | 0,0745 | 0,0026 | 0,76 | 0,0745 | 0,0041 | 1,06 | 0,1044 | 0,0060 | 1,06 | 0,1044 | 0,0094 | 1,55 | 0,1193 | 0,0076 | 1,56 | 0,1193 | 0,0119 |
| A10- | Flachau | Flachauwinkel | 2,90 | 0,1454 | 0,0051 | 2,91 | 0,1454 | 0,0080 | 4,07 | 0,2036 | 0,0117 | 4,08 | 0,2036 | 0,0184 | 6,03 | 0,2326 | 0,0148 | 6,04 | 0,2326 | 0,0232 |
| A10- | Flachauwinkel | Zederhaus | 7,32 | 0,3664 | 0,0128 | 7,33 | 0,3664 | 0,0202 | 10,26 | 0,5130 | 0,0295 | 10,28 | 0,5130 | 0,0464 | 15,20 | 0,5863 | 0,0372 | 15,22 | 0,5863 | 0,0584 |
| A10- | Zederhaus | St. Michael/Lungau | 4,83 | 0,2418 | 0,0085 | 4,83 | 0,2418 | 0,0133 | 6,77 | 0,3385 | 0,0195 | 6,78 | 0,3385 | 0,0306 | 10,03 | 0,3868 | 0,0245 | 10,04 | 0,3868 | 0,0386 |
| A10- | St. Michael/Lungau | Rennweg Katschberg | 3,54 | 0,1772 | 0,0062 | 3,54 | 0,1772 | 0,0097 | 4,96 | 0,2481 | 0,0143 | 4,97 | 0,2481 | 0,0224 | 7,35 | 0,2836 | 0,0180 | 7,36 | 0,2836 | 0,0283 |
| A102 | Seeboden | KN Spittal Millstätter See | 0,39 | 0,0388 | 0,0014 | 0,39 | 0,0388 | 0,0021 | 0,55 | 0,0543 | 0,0031 | 0,55 | 0,0543 | 0,0049 | 0,81 | 0,0621 | 0,0039 | 0,81 | 0,0621 | 0,0062 |
| A102 | KN Spittal Millstätter See | Lendorf | 0,85 | 0,0837 | 0,0029 | 0,85 | 0,0837 | 0,0046 | 1,19 | 0,1172 | 0,0067 | 1,20 | 0,1172 | 0,0106 | 1,74 | 0,1339 | 0,0085 | 1,75 | 0,1339 | 0,0134 |
| A10- | Rennweg Katschberg | Gmünd Maltatal | 3,44 | 0,3387 | 0,0119 | 3,44 | 0,3387 | 0,0186 | 4,82 | 0,4742 | 0,0273 | 4,84 | 0,4742 | 0,0428 | 7,06 | 0,5419 | 0,0344 | 7,08 | 0,5419 | 0,0540 |
| A10- | Gmünd Maltatal | KN Spittal Millstätter See | 1,96 | 0,1928 | 0,0067 | 1,96 | 0,1928 | 0,0106 | 2,74 | 0,2699 | 0,0155 | 2,75 | 0,2699 | 0,0244 | 4,02 | 0,3084 | 0,0196 | 4,03 | 0,3084 | 0,0307 |
| A10- | KN Spittal Millstätter See | Spittal Ost | 1,48 | 0,1460 | 0,0051 | 1,48 | 0,1460 | 0,0080 | 2,08 | 0,2044 | 0,0118 | 2,09 | 0,2044 | 0,0185 | 3,04 | 0,2336 | 0,0148 | 3,05 | 0,2336 | 0,0233 |
| A10- | Spittal Ost | Paternion Feistritz | 2,56 | 0,2521 | 0,0088 | 2,56 | 0,2521 | 0,0139 | 3,59 | 0,3530 | 0,0203 | 3,60 | 0,3530 | 0,0319 | 5,25 | 0,4034 | 0,0256 | 5,27 | 0,4034 | 0,0402 |
| A10- | Paternion Feistritz | Villach West | 2,76 | 0,2718 | 0,0095 | 2,76 | 0,2718 | 0,0149 | 3,87 | 0,3805 | 0,0219 | 3,88 | 0,3805 | 0,0344 | 5,66 | 0,4348 | 0,0276 | 5,68 | 0,4348 | 0,0433 |
| A10- | Villach West | Villach Ossiacher See | 1,19 | 0,1175 | 0,0041 | 1,19 | 0,1175 | 0,0065 | 1,67 | 0,1645 | 0,0095 | 1,68 | 0,1645 | 0,0149 | 2,45 | 0,1880 | 0,0119 | 2,45 | 0,1880 | 0,0187 |
| A10- | Villach Ossiacher See | KN Villach | 0,93 | 0,0918 | 0,0032 | 0,93 | 0,0918 | 0,0050 | 1,31 | 0,1285 | 0,0074 | 1,31 | 0,1285 | 0,0116 | 1,91 | 0,1469 | 0,0093 | 1,92 | 0,1469 | 0,0146 |
| A11- | KN Villach | St. Niklas Faakersee | 0,67 | 0,0657 | 0,0023 | 0,67 | 0,0657 | 0,0036 | 0,94 | 0,0920 | 0,0053 | 0,94 | 0,0920 | 0,0083 | 1,37 | 0,1051 | 0,0067 | 1,37 | 0,1051 | 0,0105 |
| A11- | St. Niklas Faakersee | St. Jakob/Rosental | 1,67 | 0,1650 | 0,0058 | 1,68 | 0,1650 | 0,0091 | 2,35 | 0,2310 | 0,0133 | 2,36 | 0,2310 | 0,0209 | 3,44 | 0,2640 | 0,0167 | 3,45 | 0,2640 | 0,0263 |
| A11- | St. Jakob/Rosental | Staatsgrenze Karawankentunnel | 15,91 | 0,1941 | 0,0068 | 15,91 | 0,1941 | 0,0107 | 22,28 | 0,2718 | 0,0156 | 22,29 | 0,2718 | 0,0246 | 33,32 | 0,3106 | 0,0197 | 33,33 | 0,3106 | 0,0310 |
| A12- | Staatsgrenze Kufstein | Kufstein Nord | 0,36 | 0,0000 | 0,0000 | 0,36 | 0,0000 | 0,0000 | 0,51 | 0,0000 | 0,0000 | 0,51 | 0,0000 | 0,0000 | 0,76 | 0,0000 | 0,0000 | 0,76 | 0,0000 | 0,0000 |
| A12- | Kufstein Nord | Kufstein Süd | 0,93 | 0,0000 | 0,0000 | 0,93 | 0,0000 | 0,0000 | 1,31 | 0,0000 | 0,0000 | 1,31 | 0,0000 | 0,0000 | 1,96 | 0,0000 | 0,0000 | 1,96 | 0,0000 | 0,0000 |
| A12- | Kufstein Süd | Kirchbichl Langkampfen | 1,27 | 0,0000 | 0,0000 | 1,27 | 0,0000 | 0,0000 | 1,78 | 0,0000 | 0,0000 | 1,78 | 0,0000 | 0,0000 | 2,68 | 0,0000 | 0,0000 | 2,68 | 0,0000 | 0,0000 |
| A12- | Kirchbichl Langkampfen | Wörgl Ost St.Johann i. T. Brixental | 1,25 | 0,0000 | 0,0000 | 1,25 | 0,0000 | 0,0000 | 1,75 | 0,0000 | 0,0000 | 1,75 | 0,0000 | 0,0000 | 2,62 | 0,0000 | 0,0000 | 2,62 | 0,0000 | 0,0000 |
| A12- | Wörgl Ost St.Johann i. T. Brixental | Wörgl West | 0,66 | 0,0000 | 0,0000 | 0,66 | 0,0000 | 0,0000 | 0,92 | 0,0000 | 0,0000 | 0,92 | 0,0000 | 0,0000 | 1,38 | 0,0000 | 0,0000 | 1,38 | 0,0000 | 0,0000 |
| A12- | Wörgl West | Kramsach Rattenberg Brixlegg | 2,80 | 0,0000 | 0,0000 | 2,80 | 0,0000 | 0,0000 | 3,92 | 0,0000 | 0,0000 | 3,92 | 0,0000 | 0,0000 | 5,88 | 0,0000 | 0,0000 | 5,88 | 0,0000 | 0,0000 |
| A12- | Kramsach Rattenberg Brixlegg | Wiesing Achensee Zillertal | 1,72 | 0,0000 | 0,0000 | 1,72 | 0,0000 | 0,0000 | 2,40 | 0,0000 | 0,0000 | 2,40 | 0,0000 | 0,0000 | 3,61 | 0,0000 | 0,0000 | 3,61 | 0,0000 | 0,0000 |
| A12- | Wiesing Achensee Zillertal | Jenbach | 0,68 | 0,0000 | 0,0000 | 0,68 | 0,0000 | 0,0000 | 0,95 | 0,0000 | 0,0000 | 0,95 | 0,0000 | 0,0000 | 1,43 | 0,0000 | 0,0000 | 1,43 | 0,0000 | 0,0000 |
| A12- | Jenbach | Schwaz | 1,50 | 0,0000 | 0,0000 | 1,50 | 0,0000 | 0,0000 | 2,10 | 0,0000 | 0,0000 | 2,10 | 0,0000 | 0,0000 | 3,15 | 0,0000 | 0,0000 | 3,15 | 0,0000 | 0,0000 |
| A12- | Schwaz | Vomp | 0,86 | 0,0000 | 0,0000 | 0,86 | 0,0000 | 0,0000 | 1,20 | 0,0000 | 0,0000 | 1,20 | 0,0000 | 0,0000 | 1,80 | 0,0000 | 0,0000 | 1,80 | 0,0000 | 0,0000 |
| A12- | Vomp | Wattens | 1,77 | 0,0000 | 0,0000 | 1,77 | 0,0000 | 0,0000 | 2,47 | 0,0000 | 0,0000 | 2,47 | 0,0000 | 0,0000 | 3,71 | 0,0000 | 0,0000 | 3,71 | 0,0000 | 0,0000 |
| A12- | Wattens | Hall/Tirol Mitte | 1,57 | 0,0000 | 0,0000 | 1,57 | 0,0000 | 0,0000 | 2,19 | 0,0000 | 0,0000 | 2,19 | 0,0000 | 0,0000 | 3,29 | 0,0000 | 0,0000 | 3,29 | 0,0000 | 0,0000 |
| A12- | Hall/Tirol Mitte | Hall/Tirol West | 0,63 | 0,0000 | 0,0000 | 0,63 | 0,0000 | 0,0000 | 0,88 | 0,0000 | 0,0000 | 0,88 | 0,0000 | 0,0000 | 1,32 | 0,0000 | 0,0000 | 1,32 | 0,0000 | 0,0000 |
| A12- | Hall/Tirol West | A12 Innsbruck Ost | 0,70 | 0,0000 | 0,0000 | 0,70 | 0,0000 | 0,0000 | 0,97 | 0,0000 | 0,0000 | 0,97 | 0,0000 | 0,0000 | 1,46 | 0,0000 | 0,0000 | 1,46 | 0,0000 | 0,0000 |
| A12- | A12 Innsbruck Ost | Innsbruck Mitte | 0,46 | 0,0113 | 0,0004 | 0,47 | 0,0113 | 0,0006 | 0,65 | 0,0158 | 0,0009 | 0,65 | 0,0158 | 0,0014 | 0,98 | 0,0181 | 0,0011 | 0,98 | 0,0181 | 0,0018 |
| A12- | Innsbruck Mitte | A12 Innsbruck West | 0,65 | 0,0640 | 0,0022 | 0,65 | 0,0640 | 0,0035 | 0,91 | 0,0896 | 0,0052 | 0,91 | 0,0896 | 0,0081 | 1,33 | 0,1024 | 0,0065 | 1,34 | 0,1024 | 0,0102 |
| A12- | A12 Innsbruck West | Innsbruck Kranebitten | 0,85 | 0,0839 | 0,0029 | 0,85 | 0,0839 | 0,0046 | 1,19 | 0,1174 | 0,0068 | 1,20 | 0,1174 | 0,0106 | 1,75 | 0,1342 | 0,0085 | 1,75 | 0,1342 | 0,0134 |
| A12- | Innsbruck Kranebitten | Zirl Ost Garmisch Seefeld | 0,99 | 0,0973 | 0,0034 | 0,99 | 0,0973 | 0,0054 | 1,39 | 0,1363 | 0,0078 | 1,39 | 0,1363 | 0,0123 | 2,03 | 0,1557 | 0,0099 | 2,03 | 0,1557 | 0,0155 |
| A12- | Zirl Ost Garmisch Seefeld | Zirl West | 0,62 | 0,0609 | 0,0021 | 0,62 | 0,0609 | 0,0033 | 0,87 | 0,0853 | 0,0049 | 0,87 | 0,0853 | 0,0077 | 1,27 | 0,0974 | 0,0062 | 1,27 | 0,0974 | 0,0097 |
| A12- | Zirl West | Petttau | 1,11 | 0,1091 | 0,0038 | 1,11 | 0,1091 | 0,0060 | 1,55 | 0,1527 | 0,0088 | 1,56 | 0,1527 | 0,0138 | 2,27 | 0,1745 | 0,0111 | 2,28 | 0,1745 | 0,0174 |
| A12- | Petttau | Telfs Ost | 1,12 | 0,1103 | 0,0039 | 1,12 | 0,1103 | 0,0061 | 1,57 | 0,1544 | 0,0089 | 1,57 | 0,1544 | 0,0139 | 2,30 | 0,1764 | 0,0112 | 2,30 | 0,1764 | 0,0176 |
| A12- | Telfs Ost | Telfs West | 0,55 | 0,0538 | 0,0019 | 0,55 | 0,0538 | 0,0030 | 0,77 | 0,0754 | 0,0043 | 0,77 | 0,0754 | 0,0068 | 1,12 | 0,0861 | 0,0055 | 1,12 | 0,0861 | 0,0086 |
| A12- | Telfs West | Mötz Reutte | 1,77 | 0,1740 | 0,0061 | 1,77 | 0,1740 | 0,0096 | 2,48 | 0,2436 | 0,0140 | 2,48 | 0,2436 | 0,0220 | 3,62 | 0,2784 | 0,0177 | 3,64 | 0,2784 | 0,0278 |
| A12- | Mötz Reutte | Haiming Ötztal | 2,05 | 0,2024 | 0,0071 | 2,06 | 0,2024 | 0,0111 | 2,88 | 0,2834 | 0,0163 | 2,89 | 0,2834 | 0,0256 | 4,22 | 0,3238 | 0,0205 | 4,23 | 0,3238 | 0,0323 |
| A12- | Haiming Ötztal | Imst | 1,63 | 0,1611 | 0,0056 | 1,64 | 0,1611 | 0,0089 | 2,29 | 0,2256 | 0,0130 | 2,30 | 0,2256 | 0,0204 | 3,36 | 0,2578 | 0,0164 | 3,37 | 0,2578 | 0,0257 |
| A12- | Imst | Imst Au | 0,28 | 0,0273 | 0,0010 | 0,28 | 0,0273 | 0,0015 | 0,39 | 0,0382 | 0,0022 | 0,39 | 0,0382 | 0,0035 | 0,57 | 0,0436 | 0,0028 | 0,57 | 0,0436 | 0,0044 |
| A12- | Imst Au | Mils | 0,59 | 0,0586 | 0,0021 | 0,60 | 0,0586 | 0,0032 | 0,83 | 0,0820 | 0,0047 | 0,84 | 0,0820 | 0,0074 | 1,22 | 0,0938 | 0,0059 | 1,22 | 0,0938 | 0,0093 |
| A12- | Mils | Mils Schönwies | 0,96 | 0,0944 | 0,0033 | 0,96 | 0,0944 | 0,0052 | 1,34 | 0,1322 | 0,0076 | 1,35 | 0,1322 | 0,0119 | 1,97 | 0,1510 | 0,0096 | 1,97 | | |

| | | | | | | | | | | | | | | | | | | | | |
|------|------------------------------------|------------------------------------|------|--------|--------|------|--------|--------|------|--------|--------|------|--------|--------|------|--------|--------|------|--------|--------|
| A14- | Staatsgrenze Hörbranz | Hörbranz Lochau | 0,26 | 0,0252 | 0,0009 | 0,26 | 0,0252 | 0,0014 | 0,36 | 0,0353 | 0,0020 | 0,36 | 0,0353 | 0,0032 | 0,53 | 0,0404 | 0,0026 | 0,53 | 0,0404 | 0,0040 |
| A14- | Hörbranz Lochau | KN Bregenz | 1,57 | 0,1550 | 0,0054 | 1,58 | 0,1550 | 0,0085 | 2,21 | 0,2170 | 0,0125 | 2,21 | 0,2170 | 0,0196 | 3,23 | 0,2480 | 0,0157 | 3,24 | 0,2480 | 0,0247 |
| A14- | KN Bregenz | Lauterach Wolfurt | 0,08 | 0,0078 | 0,0003 | 0,08 | 0,0078 | 0,0004 | 0,11 | 0,0109 | 0,0006 | 0,11 | 0,0109 | 0,0010 | 0,16 | 0,0124 | 0,0008 | 0,16 | 0,0124 | 0,0012 |
| A14- | Lauterach Wolfurt | Wolfurt Lauterach | 0,70 | 0,0690 | 0,0024 | 0,70 | 0,0690 | 0,0038 | 0,98 | 0,0965 | 0,0056 | 0,98 | 0,0965 | 0,0087 | 1,44 | 0,1103 | 0,0070 | 1,44 | 0,1103 | 0,0110 |
| A14- | Wolfurt Lauterach | Dornbirn Nord Bregenzerwald | 0,27 | 0,0267 | 0,0009 | 0,27 | 0,0267 | 0,0015 | 0,38 | 0,0374 | 0,0021 | 0,38 | 0,0374 | 0,0034 | 0,56 | 0,0427 | 0,0027 | 0,56 | 0,0427 | 0,0043 |
| A14- | Dornbirn Nord Bregenzerwald | Dornbirn Süd Lustenau | 0,76 | 0,0745 | 0,0026 | 0,76 | 0,0745 | 0,0041 | 1,06 | 0,1044 | 0,0060 | 1,06 | 0,1044 | 0,0094 | 1,55 | 0,1193 | 0,0076 | 1,56 | 0,1193 | 0,0119 |
| A14- | Dornbirn Süd Lustenau | Hohenems | 1,06 | 0,1049 | 0,0037 | 1,07 | 0,1049 | 0,0058 | 1,49 | 0,1468 | 0,0084 | 1,50 | 0,1468 | 0,0133 | 2,18 | 0,1678 | 0,0106 | 2,19 | 0,1678 | 0,0167 |
| A14- | Hohenems | Altach Götzis | 0,69 | 0,0684 | 0,0024 | 0,70 | 0,0684 | 0,0038 | 0,97 | 0,0957 | 0,0055 | 0,98 | 0,0957 | 0,0087 | 1,42 | 0,1094 | 0,0069 | 1,43 | 0,1094 | 0,0109 |
| A14- | Altach Götzis | Götzis | 0,53 | 0,0521 | 0,0018 | 0,53 | 0,0521 | 0,0029 | 0,74 | 0,0730 | 0,0042 | 0,74 | 0,0730 | 0,0066 | 1,09 | 0,0834 | 0,0053 | 1,09 | 0,0834 | 0,0083 |
| A14- | Götzis | Klaus Koblach | 0,46 | 0,0453 | 0,0016 | 0,46 | 0,0453 | 0,0025 | 0,64 | 0,0634 | 0,0036 | 0,65 | 0,0634 | 0,0057 | 0,94 | 0,0724 | 0,0046 | 0,95 | 0,0724 | 0,0072 |
| A14- | Klaus Koblach | Rankweil | 0,81 | 0,0796 | 0,0028 | 0,81 | 0,0796 | 0,0044 | 1,13 | 0,1114 | 0,0064 | 1,14 | 0,1114 | 0,0101 | 1,66 | 0,1273 | 0,0081 | 1,66 | 0,1273 | 0,0127 |
| A14- | Rankweil | Feldkirch Frastanz | 1,15 | 0,1134 | 0,0040 | 1,15 | 0,1134 | 0,0062 | 1,61 | 0,1587 | 0,0091 | 1,62 | 0,1587 | 0,0143 | 2,36 | 0,1814 | 0,0115 | 2,37 | 0,1814 | 0,0181 |
| A14- | Feldkirch Frastanz | Nenzing Bludesch | 1,82 | 0,1793 | 0,0063 | 1,82 | 0,1793 | 0,0099 | 2,55 | 0,2510 | 0,0144 | 2,56 | 0,2510 | 0,0227 | 3,73 | 0,2868 | 0,0182 | 3,74 | 0,2868 | 0,0286 |
| A14- | Nenzing Bludesch | Bludenz Nüziders | 1,35 | 0,1331 | 0,0047 | 1,35 | 0,1331 | 0,0073 | 1,89 | 0,1863 | 0,0107 | 1,90 | 0,1863 | 0,0168 | 2,77 | 0,2129 | 0,0135 | 2,78 | 0,2129 | 0,0212 |
| A14- | Bludenz Nüziders | Brandnertal | 0,19 | 0,0185 | 0,0006 | 0,19 | 0,0185 | 0,0010 | 0,26 | 0,0259 | 0,0015 | 0,26 | 0,0259 | 0,0023 | 0,39 | 0,0296 | 0,0019 | 0,39 | 0,0296 | 0,0030 |
| A14- | Brandnertal | Bludenz Bürs | 0,31 | 0,0309 | 0,0011 | 0,31 | 0,0309 | 0,0017 | 0,44 | 0,0433 | 0,0025 | 0,44 | 0,0433 | 0,0039 | 0,64 | 0,0494 | 0,0031 | 0,65 | 0,0494 | 0,0049 |
| A14- | Bludenz Bürs | Bludenz Montafon | 0,44 | 0,0438 | 0,0015 | 0,45 | 0,0438 | 0,0024 | 0,62 | 0,0613 | 0,0035 | 0,63 | 0,0613 | 0,0055 | 0,91 | 0,0701 | 0,0044 | 0,92 | 0,0701 | 0,0070 |
| A141 | KN Bregenz | Bregenz Citytunnel | 0,41 | 0,0401 | 0,0014 | 0,41 | 0,0401 | 0,0022 | 0,57 | 0,0562 | 0,0032 | 0,57 | 0,0562 | 0,0051 | 0,84 | 0,0642 | 0,0041 | 0,84 | 0,0642 | 0,0064 |
| A21- | KN Steinhäusl | Hochstraß | 0,67 | 0,0662 | 0,0023 | 0,67 | 0,0662 | 0,0036 | 0,94 | 0,0927 | 0,0053 | 0,95 | 0,0927 | 0,0084 | 1,38 | 0,1059 | 0,0067 | 1,38 | 0,1059 | 0,0106 |
| A21- | Hochstraß | Alland | 2,35 | 0,2312 | 0,0081 | 2,35 | 0,2312 | 0,0127 | 3,29 | 0,3237 | 0,0186 | 3,30 | 0,3237 | 0,0292 | 4,82 | 0,3700 | 0,0235 | 4,83 | 0,3700 | 0,0369 |
| A21- | Alland | Mayerling | 0,48 | 0,0469 | 0,0016 | 0,48 | 0,0469 | 0,0026 | 0,67 | 0,0657 | 0,0038 | 0,67 | 0,0657 | 0,0059 | 0,98 | 0,0751 | 0,0048 | 0,98 | 0,0751 | 0,0075 |
| A21- | Mayerling | Heiligenkreuz | 1,10 | 0,1087 | 0,0038 | 1,11 | 0,1087 | 0,0060 | 1,55 | 0,1522 | 0,0088 | 1,55 | 0,1522 | 0,0138 | 2,27 | 0,1740 | 0,0110 | 2,27 | 0,1740 | 0,0173 |
| A21- | Heiligenkreuz | Heiligenbrühl | 0,61 | 0,0606 | 0,0021 | 0,62 | 0,0606 | 0,0033 | 0,86 | 0,0849 | 0,0049 | 0,87 | 0,0849 | 0,0077 | 1,26 | 0,0970 | 0,0062 | 1,27 | 0,0970 | 0,0097 |
| A21- | Hinterbrühl | Gießhübl | 1,15 | 0,1137 | 0,0040 | 1,16 | 0,1137 | 0,0063 | 1,62 | 0,1592 | 0,0092 | 1,62 | 0,1592 | 0,0144 | 2,37 | 0,1819 | 0,0115 | 2,38 | 0,1819 | 0,0181 |
| A21- | Gießhübl | Brunn/Gebirge | 0,97 | 0,0951 | 0,0033 | 0,97 | 0,0951 | 0,0052 | 1,35 | 0,1332 | 0,0077 | 1,36 | 0,1332 | 0,0120 | 1,98 | 0,1522 | 0,0097 | 1,99 | 0,1522 | 0,0152 |
| A21- | Brunn/Gebirge | KN Vösendorf | 0,43 | 0,0423 | 0,0015 | 0,43 | 0,0423 | 0,0023 | 0,60 | 0,0592 | 0,0034 | 0,60 | 0,0592 | 0,0054 | 0,88 | 0,0677 | 0,0043 | 0,88 | 0,0677 | 0,0068 |
| A22- | KN Wien Kaisermühlen | Kaisermühlen | 0,34 | 0,0334 | 0,0012 | 0,34 | 0,0334 | 0,0018 | 0,48 | 0,0468 | 0,0027 | 0,48 | 0,0468 | 0,0042 | 0,70 | 0,0535 | 0,0034 | 0,70 | 0,0535 | 0,0053 |
| A22- | Kaisermühlen | Reichsbrücke | 0,28 | 0,0277 | 0,0010 | 0,28 | 0,0277 | 0,0015 | 0,39 | 0,0388 | 0,0022 | 0,40 | 0,0388 | 0,0035 | 0,58 | 0,0444 | 0,0028 | 0,58 | 0,0444 | 0,0044 |
| A22- | Reichsbrücke | Kagran Vienna International Center | 0,11 | 0,0107 | 0,0004 | 0,11 | 0,0107 | 0,0006 | 0,15 | 0,0150 | 0,0009 | 0,15 | 0,0150 | 0,0014 | 0,22 | 0,0171 | 0,0011 | 0,22 | 0,0171 | 0,0017 |
| A22- | Kagran Vienna International Center | Brigittenuerbrücke | 0,17 | 0,0171 | 0,0006 | 0,17 | 0,0171 | 0,0009 | 0,24 | 0,0239 | 0,0014 | 0,24 | 0,0239 | 0,0022 | 0,36 | 0,0274 | 0,0017 | 0,36 | 0,0274 | 0,0027 |
| A22- | Brigittenuerbrücke | Floridsdorferbrücke | 0,28 | 0,0276 | 0,0010 | 0,28 | 0,0276 | 0,0015 | 0,39 | 0,0386 | 0,0022 | 0,39 | 0,0386 | 0,0035 | 0,58 | 0,0442 | 0,0028 | 0,58 | 0,0442 | 0,0044 |
| A22- | Floridsdorferbrücke | KN Gürtel Nordbrücke | 0,18 | 0,0176 | 0,0006 | 0,18 | 0,0176 | 0,0010 | 0,25 | 0,0246 | 0,0014 | 0,25 | 0,0246 | 0,0022 | 0,37 | 0,0282 | 0,0018 | 0,37 | 0,0282 | 0,0028 |
| A22- | KN Gürtel Nordbrücke | Strebendorf | 0,61 | 0,0602 | 0,0021 | 0,61 | 0,0602 | 0,0033 | 0,86 | 0,0842 | 0,0048 | 0,86 | 0,0842 | 0,0076 | 1,25 | 0,0963 | 0,0061 | 1,26 | 0,0963 | 0,0096 |
| A221 | Wien Nordbrücke | KN Gürtel Nordbrücke | 0,18 | 0,0177 | 0,0006 | 0,18 | 0,0177 | 0,0010 | 0,25 | 0,0248 | 0,0014 | 0,25 | 0,0248 | 0,0022 | 0,37 | 0,0284 | 0,0018 | 0,37 | 0,0284 | 0,0028 |
| A221 | KN Gürtel Nordbrücke | Wien Pragerstraße | 0,19 | 0,0191 | 0,0007 | 0,19 | 0,0191 | 0,0011 | 0,27 | 0,0267 | 0,0015 | 0,27 | 0,0267 | 0,0024 | 0,40 | 0,0306 | 0,0019 | 0,40 | 0,0306 | 0,0030 |
| A221 | Wien Pragerstraße | Wien Neujedlersdorf | 0,08 | 0,0084 | 0,0003 | 0,09 | 0,0084 | 0,0005 | 0,12 | 0,0117 | 0,0007 | 0,12 | 0,0117 | 0,0011 | 0,17 | 0,0134 | 0,0008 | 0,17 | 0,0134 | 0,0013 |
| A221 | Wien Neujedlersdorf | Brünnerstr/Shuttlewortstraße | 0,22 | 0,0212 | 0,0007 | 0,22 | 0,0212 | 0,0012 | 0,30 | 0,0297 | 0,0017 | 0,30 | 0,0297 | 0,0027 | 0,44 | 0,0339 | 0,0022 | 0,44 | 0,0339 | 0,0034 |
| A22- | Strebendorf | Korneuburg Ost | 1,23 | 0,1212 | 0,0042 | 1,23 | 0,1212 | 0,0067 | 1,73 | 0,1697 | 0,0098 | 1,73 | 0,1697 | 0,0153 | 2,52 | 0,1939 | 0,0123 | 2,53 | 0,1939 | 0,0193 |
| A222 | Strebendorf | Wien Vohburggasse | 0,15 | 0,0151 | 0,0005 | 0,15 | 0,0151 | 0,0008 | 0,21 | 0,0211 | 0,0012 | 0,22 | 0,0211 | 0,0019 | 0,31 | 0,0241 | 0,0015 | 0,31 | 0,0241 | 0,0024 |
| A22- | Korneuburg Ost | KN Korneuburg | 0,79 | 0,0782 | 0,0027 | 0,80 | 0,0782 | 0,0043 | 1,11 | 0,1095 | 0,0063 | 1,12 | 0,1095 | 0,0099 | 1,63 | 0,1252 | 0,0079 | 1,63 | 0,1252 | 0,0125 |
| A22- | KN Korneuburg | Stockerau Ost | 1,15 | 0,1138 | 0,0040 | 1,16 | 0,1138 | 0,0063 | 1,62 | 0,1593 | 0,0092 | 1,63 | 0,1593 | 0,0144 | 2,37 | 0,1821 | 0,0116 | 2,38 | 0,1821 | 0,0182 |
| A22- | Stockerau Ost | Stockerau Mitte | 0,46 | 0,0454 | 0,0016 | 0,46 | 0,0454 | 0,0025 | 0,65 | 0,0635 | 0,0037 | 0,65 | 0,0635 | 0,0057 | 0,95 | 0,0726 | 0,0046 | 0,95 | 0,0726 | 0,0072 |
| A22- | Stockerau Mitte | KN Stockerau/West | 0,39 | 0,0385 | 0,0013 | 0,39 | 0,0385 | 0,0021 | 0,55 | 0,0540 | 0,0031 | 0,55 | 0,0540 | 0,0049 | 0,80 | 0,0617 | 0,0039 | 0,81 | 0,0617 | 0,0061 |
| A23- | Altmannsdorferstraße | KN Wien Inzersdorf | 0,34 | 0,0337 | 0,0012 | 0,34 | 0,0337 | 0,0019 | 0,48 | 0,0472 | 0,0027 | 0,48 | 0,0472 | 0,0043 | 0,70 | 0,0540 | 0,0034 | 0,70 | 0,0540 | 0,0054 |
| A23- | KN Wien Inzersdorf | Favoriten | 0,86 | 0,0850 | 0,0030 | 0,86 | 0,0850 | 0,0047 | 1,21 | 0,1191 | 0,0068 | 1,21 | 0,1191 | 0,0108 | 1,77 | 0,1361 | 0,0086 | 1,78 | 0,1361 | 0,0136 |
| A23- | Favoriten | KN Gürtel Landstraßer Hauptstraße | 0,54 | 0,0533 | 0,0019 | 0,54 | 0,0533 | 0,0029 | 0,76 | 0,0746 | 0,0043 | 0,76 | 0,0746 | 0,0067 | 1,11 | 0,0852 | 0,0054 | 1,11 | 0,0852 | 0,0085 |
| A23- | KN Gürtel Landstraßer Hauptstraße | St. Marx | 0,21 | 0,0202 | 0,0007 | 0,21 | 0,0202 | 0,0011 | 0,29 | 0,0283 | 0,0016 | 0,29 | 0,0283 | 0,0026 | 0,42 | 0,0324 | 0,0021 | 0,42 | 0,0324 | 0,0032 |
| A23- | St. Marx | KN Wien Prater | 0,17 | 0,0172 | 0,0006 | 0,17 | 0,0172 | 0,0009 | 0,24 | 0,0240 | 0,0014 | 0,25 | 0,0240 | 0,0022 | 0,36 | 0,0275 | 0,0017 | 0,36 | 0,0275 | 0,0027 |
| A23- | KN Wien Prater | Handelskai | 0,39 | 0,0381 | 0,0013 | 0,39 | 0,0381 | 0,0021 | 0,54 | 0,0533 | 0,0031 | 0,54 | 0,0533 | 0,0048 | 0,79 | 0,0610 | 0,0039 | 0,80 | 0,0610 | 0,0061 |
| A23- | Handelskai | KN Wien Kaisermühlen | 0,18 | 0,0174 | 0,0006 | 0,18 | 0,0174 | 0,0010 | 0,25 | 0,0244 | 0,0014 | 0,25 | 0,0244 | 0,0022 | 0,36 | 0,0279 | 0,0018 | 0,36 | 0,0279 | 0,0028 |
| A23- | KN Wien Kaisermühlen | Groß Enzersdorf Stadlau | 0,49 | 0,0478 | 0,0017 | 0,49 | 0,0478 | 0,0026 | 0,68 | 0,0669 | 0,0038 | 0,68 | 0,0669 | 0,0060 | 1,00 | 0,0765 | 0,0049 | 1,00 | 0,0765 | 0,0076 |
| A23- | Groß Enzersdorf Stadlau | Hirschstetten | 0,27 | 0,0268 | 0,0009 | 0,27 | 0,0268 | 0,0015 | 0,38 | 0,0375 | 0,0022 | 0,38 | 0,0375 | 0,0034 | 0,56 | 0,0429 | 0,0027 | 0,56 | 0,0429 | 0,0043 |
| A233 | KN Gürtel Landstraßer Hauptstraße | Wien Gürtel | 0,16 | 0,0156 | 0,0005 | 0,16 | 0,0156 | 0,0009 | 0,22 | 0,0219 | 0,0013 | 0,22 | 0,0219 | 0,0020 | 0,33 | 0,0250 | 0,0016 | 0,33 | 0,0250 | 0,0025 |
| A25- | KN A1/A25 Passau Wels | Weißkirchen | 1,79 | 0,1763 | 0,0062 | 1,79 | 0,1763 | 0,0097 | 2,51 | 0,2468 | 0,0142 | 2,52 | 0,2468 | 0,0223 | 3,67 | 0,2821 | 0,0179 | 3,68 | 0,2821 | 0,0281 |
| A25- | Weißkirchen | Marchtrenk Wels Ost | 0,64 | 0,0628 | 0,0022 | 0,64 | 0,0628 | 0,0035 | 0,89 | 0,0879 | 0,0051 | 0,90 | 0,0879 | 0,0079 | 1,31 | 0,1005 | 0,0064 | 1,31 | 0,1005 | 0,0100 |
| A25- | Marchtrenk Wels Ost | ÖBB Terminal Wels | 0,17 | 0,0169 | 0,0006 | 0,17 | 0,0169 | 0,0009 | 0,24 | 0,0237 | 0,0014 | 0,24 | 0,0237 | 0,0021 | 0,35 | 0,0270 | 0,0017 | 0,35 | 0,0270 | 0,0027 |
| | | | | | | | | | | | | | | | | | | | | |

| | | | | | | | | | | | | | | | | | | | | |
|------|-----------------------------------|-----------------------------------|------|--------|--------|------|--------|--------|------|--------|--------|------|--------|--------|------|--------|--------|------|--------|--------|
| S01- | Seyring | KN Eibesbrunn | 0,84 | 0,0824 | 0,0029 | 0,84 | 0,0824 | 0,0045 | 1,17 | 0,1154 | 0,0066 | 1,18 | 0,1154 | 0,0104 | 1,72 | 0,1319 | 0,0084 | 1,72 | 0,1319 | 0,0131 |
| S01- | KN Eibesbrunn | Hagenbrunn | 0,66 | 0,0649 | 0,0023 | 0,66 | 0,0649 | 0,0036 | 0,92 | 0,0909 | 0,0052 | 0,93 | 0,0909 | 0,0082 | 1,35 | 0,1038 | 0,0066 | 1,36 | 0,1038 | 0,0104 |
| S01- | Hagenbrunn | Korneuburg Nord | 1,41 | 0,1388 | 0,0049 | 1,41 | 0,1388 | 0,0076 | 1,98 | 0,1944 | 0,0112 | 1,98 | 0,1944 | 0,0176 | 2,89 | 0,2221 | 0,0141 | 2,90 | 0,2221 | 0,0221 |
| S01- | Korneuburg Nord | Korneuburg West | 0,57 | 0,0563 | 0,0020 | 0,57 | 0,0563 | 0,0031 | 0,80 | 0,0788 | 0,0045 | 0,80 | 0,0788 | 0,0071 | 1,17 | 0,0901 | 0,0057 | 1,18 | 0,0901 | 0,0090 |
| S01- | Korneuburg West | KN Korneuburg | 0,18 | 0,0180 | 0,0006 | 0,18 | 0,0180 | 0,0010 | 0,26 | 0,0251 | 0,0014 | 0,26 | 0,0251 | 0,0023 | 0,37 | 0,0287 | 0,0018 | 0,38 | 0,0287 | 0,0029 |
| S02- | Hirschstetten | Gewerbepark Stadlau | 0,20 | 0,0193 | 0,0007 | 0,20 | 0,0193 | 0,0011 | 0,27 | 0,0270 | 0,0016 | 0,28 | 0,0270 | 0,0024 | 0,40 | 0,0309 | 0,0020 | 0,40 | 0,0309 | 0,0031 |
| S02- | Gewerbepark Stadlau | Breitenleer Straße | 0,11 | 0,0107 | 0,0004 | 0,11 | 0,0107 | 0,0006 | 0,15 | 0,0150 | 0,0009 | 0,15 | 0,0150 | 0,0014 | 0,22 | 0,0171 | 0,0011 | 0,22 | 0,0171 | 0,0017 |
| S02- | Breitenleer Straße | Rautenweg | 0,18 | 0,0178 | 0,0006 | 0,18 | 0,0178 | 0,0010 | 0,25 | 0,0249 | 0,0014 | 0,25 | 0,0249 | 0,0022 | 0,37 | 0,0284 | 0,0018 | 0,37 | 0,0284 | 0,0028 |
| S02- | Rautenweg | Hermann Gebauer Straße | 0,20 | 0,0195 | 0,0007 | 0,20 | 0,0195 | 0,0011 | 0,28 | 0,0273 | 0,0016 | 0,28 | 0,0273 | 0,0025 | 0,41 | 0,0312 | 0,0020 | 0,41 | 0,0312 | 0,0031 |
| S02- | Hermann Gebauer Straße | Angerner Straße | 0,72 | 0,0706 | 0,0025 | 0,72 | 0,0706 | 0,0039 | 1,01 | 0,0989 | 0,0057 | 1,01 | 0,0989 | 0,0089 | 1,47 | 0,1130 | 0,0072 | 1,48 | 0,1130 | 0,0113 |
| S03- | KN Stockerau/West | Stockerau Nord | 0,20 | 0,0200 | 0,0007 | 0,20 | 0,0200 | 0,0011 | 0,28 | 0,0279 | 0,0016 | 0,29 | 0,0279 | 0,0025 | 0,42 | 0,0319 | 0,0020 | 0,42 | 0,0319 | 0,0032 |
| S03- | Stockerau Nord | Sierndorf | 1,09 | 0,1073 | 0,0038 | 1,09 | 0,1073 | 0,0059 | 1,53 | 0,1502 | 0,0086 | 1,53 | 0,1502 | 0,0136 | 2,23 | 0,1716 | 0,0109 | 2,24 | 0,1716 | 0,0171 |
| S03- | Sierndorf | Obermallebarn | 0,73 | 0,0720 | 0,0025 | 0,73 | 0,0720 | 0,0040 | 1,03 | 0,1009 | 0,0058 | 1,03 | 0,1009 | 0,0091 | 1,50 | 0,1153 | 0,0073 | 1,51 | 0,1153 | 0,0115 |
| S03- | Obermallebarn | Göllersdorf | 0,96 | 0,0951 | 0,0033 | 0,97 | 0,0951 | 0,0052 | 1,35 | 0,1332 | 0,0077 | 1,36 | 0,1332 | 0,0120 | 1,98 | 0,1522 | 0,0097 | 1,99 | 0,1522 | 0,0152 |
| S03- | Göllersdorf | Großstelzendorf | 0,39 | 0,0381 | 0,0013 | 0,39 | 0,0381 | 0,0021 | 0,54 | 0,0533 | 0,0031 | 0,54 | 0,0533 | 0,0048 | 0,79 | 0,0610 | 0,0039 | 0,80 | 0,0610 | 0,0061 |
| S03- | Großstelzendorf | Hollabrunn Süd | 0,93 | 0,0916 | 0,0032 | 0,93 | 0,0916 | 0,0050 | 1,30 | 0,1283 | 0,0074 | 1,31 | 0,1283 | 0,0116 | 1,91 | 0,1466 | 0,0093 | 1,91 | 0,1466 | 0,0146 |
| S04- | KN Mattersburg | Sigleß | 0,48 | 0,0474 | 0,0017 | 0,48 | 0,0474 | 0,0026 | 0,67 | 0,0663 | 0,0038 | 0,68 | 0,0663 | 0,0060 | 0,99 | 0,0758 | 0,0048 | 0,99 | 0,0758 | 0,0076 |
| S04- | Sigleß | Bad Sauerbrunn | 1,12 | 0,1107 | 0,0039 | 1,12 | 0,1107 | 0,0061 | 1,58 | 0,1549 | 0,0089 | 1,58 | 0,1549 | 0,0140 | 2,31 | 0,1771 | 0,0112 | 2,31 | 0,1771 | 0,0177 |
| S04- | Bad Sauerbrunn | Neudörfel | 0,47 | 0,0465 | 0,0016 | 0,47 | 0,0465 | 0,0026 | 0,66 | 0,0651 | 0,0037 | 0,66 | 0,0651 | 0,0059 | 0,97 | 0,0744 | 0,0047 | 0,97 | 0,0744 | 0,0074 |
| S04- | Neudörfel | Wr. Neustadt Ost | 0,49 | 0,0487 | 0,0017 | 0,49 | 0,0487 | 0,0027 | 0,69 | 0,0682 | 0,0039 | 0,70 | 0,0682 | 0,0062 | 1,01 | 0,0779 | 0,0049 | 1,02 | 0,0779 | 0,0078 |
| S04- | Wr. Neustadt Ost | Katzelsdorf | 0,23 | 0,0228 | 0,0008 | 0,23 | 0,0228 | 0,0013 | 0,32 | 0,0319 | 0,0018 | 0,33 | 0,0319 | 0,0029 | 0,48 | 0,0365 | 0,0023 | 0,48 | 0,0365 | 0,0036 |
| S04- | Katzelsdorf | Lanzenkirchen | 0,19 | 0,0191 | 0,0007 | 0,19 | 0,0191 | 0,0010 | 0,27 | 0,0267 | 0,0015 | 0,27 | 0,0267 | 0,0024 | 0,40 | 0,0305 | 0,0019 | 0,40 | 0,0305 | 0,0030 |
| S04- | Lanzenkirchen | Wr. Neustadt Süd | 0,17 | 0,0169 | 0,0006 | 0,17 | 0,0169 | 0,0009 | 0,24 | 0,0237 | 0,0014 | 0,24 | 0,0237 | 0,0021 | 0,35 | 0,0271 | 0,0017 | 0,35 | 0,0271 | 0,0027 |
| S04- | Wr. Neustadt Süd | KN Wr. Neustadt | 0,28 | 0,0280 | 0,0010 | 0,28 | 0,0280 | 0,0015 | 0,40 | 0,0392 | 0,0023 | 0,40 | 0,0392 | 0,0035 | 0,58 | 0,0448 | 0,0028 | 0,59 | 0,0448 | 0,0045 |
| S05- | KN Stockerau/West | Tulln | 1,96 | 0,1932 | 0,0068 | 1,96 | 0,1932 | 0,0106 | 2,75 | 0,2705 | 0,0156 | 2,76 | 0,2705 | 0,0244 | 4,02 | 0,3091 | 0,0196 | 4,04 | 0,3091 | 0,0308 |
| S05- | Tulln | Königsbrunn / Wagram | 2,46 | 0,2420 | 0,0085 | 2,46 | 0,2420 | 0,0133 | 3,44 | 0,3388 | 0,0195 | 3,46 | 0,3388 | 0,0306 | 5,04 | 0,3872 | 0,0246 | 5,06 | 0,3872 | 0,0386 |
| S05- | Königsbrunn / Wagram | Kirchberg/Wagram | 0,65 | 0,0645 | 0,0023 | 0,66 | 0,0645 | 0,0035 | 0,92 | 0,0903 | 0,0052 | 0,92 | 0,0903 | 0,0082 | 1,34 | 0,1032 | 0,0065 | 1,35 | 0,1032 | 0,0103 |
| S05- | Kirchberg/Wagram | Fels / Wagram | 0,49 | 0,0483 | 0,0017 | 0,49 | 0,0483 | 0,0023 | 0,69 | 0,0676 | 0,0039 | 0,69 | 0,0676 | 0,0061 | 1,01 | 0,0773 | 0,0049 | 1,01 | 0,0773 | 0,0077 |
| S05- | Fels / Wagram | Grafenwörth | 1,13 | 0,1112 | 0,0039 | 1,13 | 0,1112 | 0,0061 | 1,58 | 0,1557 | 0,0090 | 1,59 | 0,1557 | 0,0141 | 2,32 | 0,1780 | 0,0113 | 2,32 | 0,1780 | 0,0177 |
| S05- | Grafenwörth | Jettsdorf | 0,50 | 0,0497 | 0,0017 | 0,51 | 0,0497 | 0,0027 | 0,71 | 0,0696 | 0,0040 | 0,71 | 0,0696 | 0,0063 | 1,04 | 0,0796 | 0,0050 | 1,04 | 0,0796 | 0,0079 |
| S06- | KN Seebein | Neunkirchen | 0,77 | 0,0759 | 0,0027 | 0,77 | 0,0759 | 0,0042 | 1,08 | 0,1063 | 0,0061 | 1,08 | 0,1063 | 0,0096 | 1,58 | 0,1214 | 0,0077 | 1,59 | 0,1214 | 0,0121 |
| S06- | Neunkirchen | Gloggnitz | 2,47 | 0,2434 | 0,0085 | 2,47 | 0,2434 | 0,0134 | 3,46 | 0,3408 | 0,0196 | 3,48 | 0,3408 | 0,0308 | 5,07 | 0,3894 | 0,0247 | 5,08 | 0,3894 | 0,0388 |
| S06- | Gloggnitz | Maria Schutz | 1,57 | 0,1551 | 0,0054 | 1,58 | 0,1551 | 0,0085 | 2,21 | 0,2172 | 0,0125 | 2,22 | 0,2172 | 0,0196 | 3,23 | 0,2482 | 0,0157 | 3,24 | 0,2482 | 0,0247 |
| S06- | Maria Schutz | Spital / Semmering | 1,34 | 0,1317 | 0,0046 | 1,34 | 0,1317 | 0,0072 | 1,87 | 0,1844 | 0,0106 | 1,88 | 0,1844 | 0,0167 | 2,74 | 0,2107 | 0,0134 | 2,75 | 0,2107 | 0,0210 |
| S06- | Spital / Semmering | Mürzzuschlag Ost | 1,12 | 0,1100 | 0,0039 | 1,12 | 0,1100 | 0,0061 | 1,57 | 0,1540 | 0,0089 | 1,57 | 0,1540 | 0,0139 | 2,29 | 0,1760 | 0,0112 | 2,30 | 0,1760 | 0,0175 |
| S06- | Mürzzuschlag Ost | Mariazell, Mürzsteg, Mürzzuschlag | 0,99 | 0,0975 | 0,0034 | 0,99 | 0,0975 | 0,0054 | 1,39 | 0,1365 | 0,0079 | 1,39 | 0,1365 | 0,0123 | 2,03 | 0,1560 | 0,0099 | 2,04 | 0,1560 | 0,0156 |
| S06- | Mariazell, Mürzsteg, Mürzzuschlag | Hönigsberg | 0,71 | 0,0695 | 0,0024 | 0,71 | 0,0695 | 0,0038 | 0,99 | 0,0974 | 0,0056 | 0,99 | 0,0974 | 0,0088 | 1,45 | 0,1113 | 0,0071 | 1,45 | 0,1113 | 0,0111 |
| S06- | Hönigsberg | Langenwang | 0,39 | 0,0385 | 0,0013 | 0,39 | 0,0385 | 0,0021 | 0,55 | 0,0538 | 0,0031 | 0,55 | 0,0538 | 0,0049 | 0,80 | 0,0615 | 0,0039 | 0,80 | 0,0615 | 0,0061 |
| S06- | Langenwang | Krieglach | 0,46 | 0,0457 | 0,0016 | 0,46 | 0,0457 | 0,0025 | 0,65 | 0,0640 | 0,0037 | 0,65 | 0,0640 | 0,0058 | 0,95 | 0,0731 | 0,0046 | 0,95 | 0,0731 | 0,0073 |
| S06- | Krieglach | Mitterdorf | 1,17 | 0,1155 | 0,0040 | 1,17 | 0,1155 | 0,0064 | 1,64 | 0,1616 | 0,0093 | 1,65 | 0,1616 | 0,0146 | 2,41 | 0,1847 | 0,0117 | 2,41 | 0,1847 | 0,0184 |
| S06- | Mitterdorf | Kindberg Ost | 1,19 | 0,1174 | 0,0041 | 1,19 | 0,1174 | 0,0065 | 1,67 | 0,1644 | 0,0095 | 1,68 | 0,1644 | 0,0149 | 2,45 | 0,1878 | 0,0119 | 2,45 | 0,1878 | 0,0187 |
| S06- | Kindberg Ost | Kindberg West | 0,26 | 0,0252 | 0,0009 | 0,26 | 0,0252 | 0,0014 | 0,36 | 0,0353 | 0,0020 | 0,36 | 0,0353 | 0,0032 | 0,53 | 0,0403 | 0,0026 | 0,53 | 0,0403 | 0,0040 |
| S06- | Kindberg West | Kindberg Dörfel | 0,26 | 0,0252 | 0,0009 | 0,26 | 0,0252 | 0,0014 | 0,36 | 0,0353 | 0,0020 | 0,36 | 0,0353 | 0,0032 | 0,52 | 0,0403 | 0,0026 | 0,53 | 0,0403 | 0,0040 |
| S06- | Kindberg Dörfel | Allerheiligen Mürzhofen | 0,58 | 0,0567 | 0,0020 | 0,58 | 0,0567 | 0,0031 | 0,81 | 0,0794 | 0,0046 | 0,81 | 0,0794 | 0,0072 | 1,18 | 0,0908 | 0,0058 | 1,18 | 0,0908 | 0,0090 |
| S06- | Allerheiligen Mürzhofen | St. Marein | 0,86 | 0,0852 | 0,0030 | 0,87 | 0,0852 | 0,0047 | 1,21 | 0,1193 | 0,0069 | 1,22 | 0,1193 | 0,0108 | 1,77 | 0,1363 | 0,0086 | 1,78 | 0,1363 | 0,0136 |
| S06- | St. Marein | Kapfenberg | 0,61 | 0,0604 | 0,0021 | 0,61 | 0,0604 | 0,0033 | 0,86 | 0,0846 | 0,0049 | 0,86 | 0,0846 | 0,0076 | 1,26 | 0,0966 | 0,0061 | 1,26 | 0,0966 | 0,0096 |
| S06- | Kapfenberg | KN Bruck/Mur | 1,14 | 0,1128 | 0,0039 | 1,15 | 0,1128 | 0,0062 | 1,61 | 0,1579 | 0,0091 | 1,61 | 0,1579 | 0,0143 | 2,35 | 0,1804 | 0,0114 | 2,36 | 0,1804 | 0,0180 |
| S06- | KN Bruck/Mur | ASt Bruck/Mur | 0,98 | 0,0967 | 0,0034 | 0,98 | 0,0967 | 0,0053 | 1,38 | 0,1354 | 0,0078 | 1,38 | 0,1354 | 0,0122 | 2,02 | 0,1548 | 0,0098 | 2,02 | 0,1548 | 0,0154 |
| S06- | ASt Bruck/Mur | Niklasdorf | 0,91 | 0,0894 | 0,0031 | 0,91 | 0,0894 | 0,0049 | 1,27 | 0,1251 | 0,0072 | 1,28 | 0,1251 | 0,0113 | 1,86 | 0,1430 | 0,0091 | 1,87 | 0,1430 | 0,0143 |
| S06- | Niklasdorf | Leoben Ost | 0,97 | 0,0953 | 0,0033 | 0,97 | 0,0953 | 0,0052 | 1,36 | 0,1334 | 0,0077 | 1,36 | 0,1334 | 0,0121 | 1,99 | 0,1525 | 0,0097 | 1,99 | 0,1525 | 0,0152 |
| S06- | Leoben Ost | Leoben West | 1,08 | 0,1068 | 0,0037 | 1,09 | 0,1068 | 0,0059 | 1,52 | 0,1495 | 0,0086 | 1,52 | 0,1495 | 0,0135 | 2,22 | 0,1708 | 0,0108 | 2,23 | 0,170 | |

| | | | | | | | | | | | | | | | | | | | | |
|------|-----------------------------|-----------------------------|------|--------|--------|------|--------|--------|------|--------|--------|------|--------|--------|------|--------|--------|------|--------|--------|
| S31- | Eisenstadt Mitte | KN Eisenstadt | 0,39 | 0,0380 | 0,0013 | 0,39 | 0,0380 | 0,0021 | 0,54 | 0,0533 | 0,0031 | 0,54 | 0,0533 | 0,0048 | 0,79 | 0,0609 | 0,0039 | 0,79 | 0,0609 | 0,0061 |
| S31- | KN Eisenstadt | Wulkaprodersdorf | 0,51 | 0,0506 | 0,0018 | 0,51 | 0,0506 | 0,0028 | 0,72 | 0,0709 | 0,0041 | 0,72 | 0,0709 | 0,0064 | 1,05 | 0,0810 | 0,0051 | 1,06 | 0,0810 | 0,0081 |
| S31- | Wulkaprodersdorf | KN Mattersburg | 1,46 | 0,1438 | 0,0050 | 1,46 | 0,1438 | 0,0079 | 2,05 | 0,2013 | 0,0116 | 2,05 | 0,2013 | 0,0182 | 2,99 | 0,2300 | 0,0146 | 3,00 | 0,2300 | 0,0229 |
| S31- | KN Mattersburg | Forchtenstein | 1,06 | 0,1041 | 0,0036 | 1,06 | 0,1041 | 0,0057 | 1,48 | 0,1457 | 0,0084 | 1,49 | 0,1457 | 0,0132 | 2,17 | 0,1665 | 0,0106 | 2,17 | 0,1665 | 0,0166 |
| S31- | Forchtenstein | Sieggraben | 1,48 | 0,1454 | 0,0051 | 1,48 | 0,1454 | 0,0080 | 2,07 | 0,2036 | 0,0117 | 2,08 | 0,2036 | 0,0184 | 3,03 | 0,2326 | 0,0148 | 3,04 | 0,2326 | 0,0232 |
| S31- | Sieggraben | Weppersdorf/Kobersdorf | 1,78 | 0,1752 | 0,0061 | 1,78 | 0,1752 | 0,0096 | 2,49 | 0,2452 | 0,0141 | 2,50 | 0,2452 | 0,0222 | 3,65 | 0,2803 | 0,0178 | 3,66 | 0,2803 | 0,0279 |
| S31- | Weppersdorf/Kobersdorf | Weppersdorf/Markt St.Martin | 0,37 | 0,0360 | 0,0013 | 0,37 | 0,0360 | 0,0020 | 0,51 | 0,0504 | 0,0029 | 0,51 | 0,0504 | 0,0046 | 0,75 | 0,0576 | 0,0037 | 0,75 | 0,0576 | 0,0057 |
| S31- | Weppersdorf/Markt St.Martin | Neutal | 0,84 | 0,0831 | 0,0029 | 0,85 | 0,0831 | 0,0046 | 1,18 | 0,1164 | 0,0067 | 1,19 | 0,1164 | 0,0105 | 1,73 | 0,1330 | 0,0084 | 1,74 | 0,1330 | 0,0133 |
| S31- | Neutal | Stoob Süd | 0,74 | 0,0726 | 0,0025 | 0,74 | 0,0726 | 0,0040 | 1,03 | 0,1017 | 0,0058 | 1,04 | 0,1017 | 0,0092 | 1,51 | 0,1162 | 0,0074 | 1,52 | 0,1162 | 0,0116 |
| S31- | Stoob Süd | Oberpullendorf | 0,80 | 0,0793 | 0,0028 | 0,81 | 0,0793 | 0,0044 | 1,13 | 0,1110 | 0,0064 | 1,13 | 0,1110 | 0,0100 | 1,65 | 0,1269 | 0,0080 | 1,66 | 0,1269 | 0,0126 |
| S33- | KN St. Pölten | St. Pölten Ost | 0,44 | 0,0430 | 0,0015 | 0,44 | 0,0430 | 0,0024 | 0,61 | 0,0603 | 0,0035 | 0,61 | 0,0603 | 0,0054 | 0,90 | 0,0689 | 0,0044 | 0,90 | 0,0689 | 0,0069 |
| S33- | St. Pölten Ost | St. Pölten Nord | 0,77 | 0,0761 | 0,0027 | 0,77 | 0,0761 | 0,0042 | 1,08 | 0,1065 | 0,0061 | 1,09 | 0,1065 | 0,0096 | 1,58 | 0,1217 | 0,0077 | 1,59 | 0,1217 | 0,0121 |
| S33- | St. Pölten Nord | Herzogenburg Süd | 0,82 | 0,0805 | 0,0028 | 0,82 | 0,0805 | 0,0044 | 1,15 | 0,1128 | 0,0065 | 1,15 | 0,1128 | 0,0102 | 1,68 | 0,1289 | 0,0082 | 1,68 | 0,1289 | 0,0128 |
| S33- | Herzogenburg Süd | Herzogenburg Stadt | 0,44 | 0,0430 | 0,0015 | 0,44 | 0,0430 | 0,0024 | 0,61 | 0,0602 | 0,0035 | 0,61 | 0,0602 | 0,0054 | 0,90 | 0,0688 | 0,0044 | 0,90 | 0,0688 | 0,0069 |
| S33- | Herzogenburg Stadt | Herzogenburg Nord | 0,24 | 0,0238 | 0,0008 | 0,24 | 0,0238 | 0,0013 | 0,34 | 0,0334 | 0,0019 | 0,34 | 0,0334 | 0,0030 | 0,50 | 0,0381 | 0,0024 | 0,50 | 0,0381 | 0,0038 |
| S33- | Herzogenburg Nord | Traismauer Süd | 1,18 | 0,1160 | 0,0041 | 1,18 | 0,1160 | 0,0064 | 1,65 | 0,1624 | 0,0093 | 1,66 | 0,1624 | 0,0147 | 2,42 | 0,1856 | 0,0118 | 2,42 | 0,1856 | 0,0185 |
| S33- | Traismauer Süd | Traismauer Nord | 0,60 | 0,0590 | 0,0021 | 0,60 | 0,0590 | 0,0032 | 0,84 | 0,0826 | 0,0047 | 0,84 | 0,0826 | 0,0075 | 1,23 | 0,0944 | 0,0060 | 1,23 | 0,0944 | 0,0094 |
| S33- | Traismauer Nord | Jettsdorf | 1,01 | 0,0996 | 0,0035 | 1,01 | 0,0996 | 0,0055 | 1,42 | 0,1395 | 0,0080 | 1,42 | 0,1395 | 0,0126 | 2,08 | 0,1594 | 0,0101 | 2,08 | 0,1594 | 0,0159 |
| S35- | KN Bruck/Mur | Pernegg | 1,24 | 0,1218 | 0,0043 | 1,24 | 0,1218 | 0,0067 | 1,73 | 0,1705 | 0,0098 | 1,74 | 0,1705 | 0,0154 | 2,54 | 0,1949 | 0,0124 | 2,54 | 0,1949 | 0,0194 |
| S35- | Pernegg | Mixnitz/Mautstatt | 0,90 | 0,0886 | 0,0031 | 0,90 | 0,0886 | 0,0049 | 1,26 | 0,1240 | 0,0071 | 1,26 | 0,1240 | 0,0112 | 1,85 | 0,1417 | 0,0090 | 1,85 | 0,1417 | 0,0141 |
| S35- | Mixnitz/Mautstatt | Röthelstein | 1,08 | 0,1062 | 0,0037 | 1,08 | 0,1062 | 0,0058 | 1,51 | 0,1487 | 0,0085 | 1,52 | 0,1487 | 0,0134 | 2,21 | 0,1699 | 0,0108 | 2,22 | 0,1699 | 0,0169 |
| S35- | Röthelstein | Laufnitzdorf | 0,52 | 0,0512 | 0,0018 | 0,52 | 0,0512 | 0,0028 | 0,73 | 0,0717 | 0,0041 | 0,73 | 0,0717 | 0,0065 | 1,07 | 0,0819 | 0,0052 | 1,07 | 0,0819 | 0,0082 |
| S35- | Laufnitzdorf | Rothleiten | 0,59 | 0,0582 | 0,0020 | 0,59 | 0,0582 | 0,0032 | 0,83 | 0,0815 | 0,0047 | 0,83 | 0,0815 | 0,0074 | 1,21 | 0,0931 | 0,0059 | 1,22 | 0,0931 | 0,0093 |
| S35- | Rothleiten | Frohnleiten Nord | 0,37 | 0,0362 | 0,0013 | 0,37 | 0,0362 | 0,0020 | 0,52 | 0,0507 | 0,0029 | 0,52 | 0,0507 | 0,0046 | 0,76 | 0,0580 | 0,0037 | 0,76 | 0,0580 | 0,0058 |
| S35- | Frohnleiten Nord | Frohnleiten | 0,17 | 0,0167 | 0,0006 | 0,17 | 0,0167 | 0,0009 | 0,24 | 0,0234 | 0,0013 | 0,24 | 0,0234 | 0,0021 | 0,35 | 0,0268 | 0,0017 | 0,35 | 0,0268 | 0,0027 |
| S35- | Frohnleiten | Badl Peggau | 1,14 | 0,1124 | 0,0039 | 1,14 | 0,1124 | 0,0062 | 1,60 | 0,1574 | 0,0090 | 1,61 | 0,1574 | 0,0142 | 2,38 | 0,1798 | 0,0114 | 2,35 | 0,1798 | 0,0179 |
| S35- | Badl Peggau | Peggau Mitte | 0,38 | 0,0376 | 0,0013 | 0,38 | 0,0376 | 0,0021 | 0,54 | 0,0526 | 0,0030 | 0,54 | 0,0526 | 0,0048 | 0,78 | 0,0602 | 0,0038 | 0,79 | 0,0602 | 0,0060 |
| S35- | Peggau Mitte | KN Peggau Deutschfeistritz | 0,79 | 0,0783 | 0,0027 | 0,80 | 0,0783 | 0,0043 | 1,11 | 0,1096 | 0,0063 | 1,12 | 0,1096 | 0,0099 | 1,63 | 0,1253 | 0,0079 | 1,64 | 0,1253 | 0,0125 |
| S36- | KN St. Michael | St. Stefan ob Leoben | 0,65 | 0,0645 | 0,0023 | 0,66 | 0,0645 | 0,0035 | 0,92 | 0,0903 | 0,0052 | 0,92 | 0,0903 | 0,0082 | 1,34 | 0,1032 | 0,0065 | 1,35 | 0,1032 | 0,0103 |
| S36- | St. Stefan ob Leoben | Kraubath | 0,70 | 0,0693 | 0,0024 | 0,70 | 0,0693 | 0,0038 | 0,99 | 0,0970 | 0,0056 | 0,99 | 0,0970 | 0,0088 | 1,44 | 0,1109 | 0,0070 | 1,45 | 0,1109 | 0,0111 |
| S36- | Kraubath | Feistritz St. Lorenzen | 1,24 | 0,1217 | 0,0043 | 1,24 | 0,1217 | 0,0067 | 1,73 | 0,1704 | 0,0098 | 1,74 | 0,1704 | 0,0154 | 2,54 | 0,1948 | 0,0124 | 2,54 | 0,1948 | 0,0194 |
| S36- | Feistritz St. Lorenzen | Knittelfeld Ost | 1,42 | 0,1397 | 0,0049 | 1,42 | 0,1397 | 0,0077 | 1,99 | 0,1956 | 0,0112 | 2,00 | 0,1956 | 0,0177 | 2,91 | 0,2236 | 0,0142 | 2,92 | 0,2236 | 0,0223 |
| S36- | Knittelfeld Ost | Knittelfeld West | 0,60 | 0,0593 | 0,0021 | 0,60 | 0,0593 | 0,0033 | 0,84 | 0,0830 | 0,0048 | 0,85 | 0,0830 | 0,0075 | 1,23 | 0,0948 | 0,0060 | 1,24 | 0,0948 | 0,0095 |
| S36- | Knittelfeld West | Zeitweg Ost Spielberg | 0,19 | 0,0185 | 0,0006 | 0,19 | 0,0185 | 0,0010 | 0,26 | 0,0259 | 0,0015 | 0,26 | 0,0259 | 0,0023 | 0,39 | 0,0296 | 0,0019 | 0,39 | 0,0296 | 0,0030 |
| S36- | Zeitweg Ost Spielberg | Zeitweg West | 1,22 | 0,1204 | 0,0042 | 1,22 | 0,1204 | 0,0066 | 1,71 | 0,1686 | 0,0097 | 1,72 | 0,1686 | 0,0152 | 2,51 | 0,1926 | 0,0122 | 2,52 | 0,1926 | 0,0192 |
| S36- | Zeitweg West | Judenburg Ost Fohnsdorf | 0,61 | 0,0605 | 0,0021 | 0,62 | 0,0605 | 0,0033 | 0,86 | 0,0848 | 0,0049 | 0,86 | 0,0848 | 0,0077 | 1,26 | 0,0969 | 0,0061 | 1,26 | 0,0969 | 0,0097 |
| S36- | Judenburg Ost Fohnsdorf | Judenburg West | 0,95 | 0,0939 | 0,0033 | 0,95 | 0,0939 | 0,0052 | 1,34 | 0,1315 | 0,0076 | 1,34 | 0,1315 | 0,0119 | 1,96 | 0,1503 | 0,0095 | 1,96 | 0,1503 | 0,0150 |
| S36- | As B317 (prov.) | St. Georgen Ost | 0,10 | 0,0098 | 0,0003 | 0,10 | 0,0098 | 0,0005 | 0,14 | 0,0137 | 0,0008 | 0,14 | 0,0137 | 0,0012 | 0,20 | 0,0157 | 0,0010 | 0,21 | 0,0157 | 0,0016 |
| S36- | St. Georgen Ost | St. Georgen West | 0,18 | 0,0182 | 0,0006 | 0,18 | 0,0182 | 0,0010 | 0,26 | 0,0255 | 0,0015 | 0,26 | 0,0255 | 0,0023 | 0,38 | 0,0291 | 0,0018 | 0,38 | 0,0291 | 0,0029 |
| S37- | St. Veit Nord | St. Veit Mitte / Brückl | 0,58 | 0,0570 | 0,0020 | 0,58 | 0,0570 | 0,0031 | 0,81 | 0,0797 | 0,0046 | 0,81 | 0,0797 | 0,0072 | 1,19 | 0,0911 | 0,0058 | 1,19 | 0,0911 | 0,0091 |
| S37- | St. Veit Mitte / Brückl | St. Veit Süd | 0,49 | 0,0484 | 0,0017 | 0,49 | 0,0484 | 0,0027 | 0,69 | 0,0678 | 0,0039 | 0,69 | 0,0678 | 0,0061 | 1,01 | 0,0775 | 0,0049 | 1,01 | 0,0775 | 0,0077 |
| S37- | St. Veit Süd | St. Veit Industriegebiet | 0,37 | 0,0364 | 0,0013 | 0,37 | 0,0364 | 0,0020 | 0,52 | 0,0510 | 0,0029 | 0,52 | 0,0510 | 0,0046 | 0,76 | 0,0582 | 0,0037 | 0,76 | 0,0582 | 0,0058 |
| S37- | St. Veit Industriegebiet | Maria Saal | 1,30 | 0,1278 | 0,0045 | 1,30 | 0,1278 | 0,0070 | 1,82 | 0,1789 | 0,0103 | 1,82 | 0,1789 | 0,0162 | 2,66 | 0,2044 | 0,0130 | 2,67 | 0,2044 | 0,0204 |
| S37- | Maria Saal | Karnburg | 0,46 | 0,0456 | 0,0016 | 0,46 | 0,0456 | 0,0025 | 0,65 | 0,0639 | 0,0037 | 0,65 | 0,0639 | 0,0058 | 0,95 | 0,0730 | 0,0046 | 0,95 | 0,0730 | 0,0073 |
| S37- | Karnburg | Klagenfurt Nord | 0,40 | 0,0398 | 0,0014 | 0,40 | 0,0398 | 0,0022 | 0,57 | 0,0557 | 0,0032 | 0,57 | 0,0557 | 0,0050 | 0,83 | 0,0637 | 0,0040 | 0,83 | 0,0637 | 0,0064 |
| A01- | Preßbaum | Wien Auhof | 2,83 | 0,2786 | 0,0098 | 2,83 | 0,2786 | 0,0153 | 3,97 | 0,3900 | 0,0224 | 3,98 | 0,3900 | 0,0352 | 5,80 | 0,4458 | 0,0283 | 5,82 | 0,4458 | 0,0444 |
| A01- | KN Steinhäusl | Preßbaum | 1,60 | 0,1574 | 0,0055 | 1,60 | 0,1574 | 0,0087 | 2,24 | 0,2204 | 0,0127 | 2,25 | 0,2204 | 0,0199 | 3,28 | 0,2519 | 0,0160 | 3,29 | 0,2519 | 0,0251 |
| A01- | Alltengbach | KN Steinhäusl | 0,94 | 0,0926 | 0,0032 | 0,94 | 0,0926 | 0,0051 | 1,32 | 0,1296 | 0,0075 | 1,32 | 0,1296 | 0,0117 | 1,93 | 0,1481 | 0,0094 | 1,93 | 0,1481 | 0,0148 |
| A01- | St. Christophen | Alltengbach | 1,12 | 0,1104 | 0,0039 | 1,12 | 0,1104 | 0,0061 | 1,57 | 0,1545 | 0,0089 | 1,58 | 0,1545 | 0,0140 | 2,30 | 0,1766 | 0,0112 | 2,31 | 0,1766 | 0,0176 |
| A01- | Böheimkirchen | St. Christophen | 1,34 | 0,1324 | 0,0046 | 1,35 | 0,1324 | 0,0073 | 1,88 | 0,1853 | 0,0107 | 1,89 | 0,1853 | 0,0167 | 2,76 | 0,2118 | 0,0134 | 2,77 | 0,2118 | 0,0211 |
| A01- | KN St. Pölten | Böheimkirchen | 1,31 | 0,1295 | 0,0045 | 1,32 | 0,1295 | 0,0071 | 1,84 | 0,1813 | 0,0104 | 1,85 | 0,1813 | 0,0164 | 2,70 | 0,2072 | 0,0131 | | | |

| | | | | | | | | | | | | | | | | | | | | |
|------|----------------------------|----------------------------|------|--------|--------|------|--------|--------|------|--------|--------|------|--------|--------|------|--------|--------|------|--------|--------|
| A01- | Laakirchen West | Laakirchen Ost | 0,73 | 0,0724 | 0,0025 | 0,74 | 0,0724 | 0,0040 | 1,03 | 0,1014 | 0,0058 | 1,03 | 0,1014 | 0,0092 | 1,51 | 0,1158 | 0,0073 | 1,51 | 0,1158 | 0,0115 |
| A01- | Regau | Laakirchen West | 1,44 | 0,1419 | 0,0050 | 1,44 | 0,1419 | 0,0078 | 2,02 | 0,1987 | 0,0114 | 2,03 | 0,1987 | 0,0180 | 2,96 | 0,2271 | 0,0144 | 2,96 | 0,2271 | 0,0226 |
| A01- | Schörfling | Regau | 1,89 | 0,1865 | 0,0065 | 1,90 | 0,1865 | 0,0103 | 2,65 | 0,2611 | 0,0150 | 2,66 | 0,2611 | 0,0236 | 3,68 | 0,2984 | 0,0189 | 3,90 | 0,2984 | 0,0297 |
| A01- | Seewalchen | Schörfling | 0,29 | 0,0289 | 0,0010 | 0,29 | 0,0289 | 0,0016 | 0,41 | 0,0405 | 0,0023 | 0,41 | 0,0405 | 0,0037 | 0,60 | 0,0462 | 0,0029 | 0,60 | 0,0462 | 0,0046 |
| A01- | St. Georgen | Seewalchen | 1,71 | 0,1690 | 0,0059 | 1,72 | 0,1690 | 0,0093 | 2,41 | 0,2367 | 0,0136 | 2,41 | 0,2367 | 0,0214 | 3,52 | 0,2705 | 0,0172 | 3,53 | 0,2705 | 0,0270 |
| A01- | Oberwang | St. Georgen | 2,29 | 0,2254 | 0,0079 | 2,29 | 0,2254 | 0,0124 | 3,21 | 0,3156 | 0,0181 | 3,22 | 0,3156 | 0,0285 | 4,70 | 0,3606 | 0,0229 | 4,71 | 0,3606 | 0,0360 |
| A01- | Mondsee | Oberwang | 2,10 | 0,2075 | 0,0073 | 2,11 | 0,2075 | 0,0114 | 2,95 | 0,2904 | 0,0167 | 2,96 | 0,2904 | 0,0262 | 4,32 | 0,3319 | 0,0211 | 4,33 | 0,3319 | 0,0331 |
| A01- | Thalgau | Mondsee | 1,94 | 0,1913 | 0,0067 | 1,94 | 0,1913 | 0,0105 | 2,72 | 0,2678 | 0,0154 | 2,73 | 0,2678 | 0,0242 | 3,98 | 0,3060 | 0,0194 | 4,00 | 0,3060 | 0,0305 |
| A01- | Wallersee | Thalgau | 1,48 | 0,1457 | 0,0051 | 1,48 | 0,1457 | 0,0080 | 2,07 | 0,2040 | 0,0117 | 2,08 | 0,2040 | 0,0184 | 3,04 | 0,2332 | 0,0148 | 3,04 | 0,2332 | 0,0232 |
| A01- | Salzburg Nord | Wallersee | 1,43 | 0,1411 | 0,0049 | 1,43 | 0,1411 | 0,0078 | 2,01 | 0,1975 | 0,0114 | 2,01 | 0,1975 | 0,0178 | 2,94 | 0,2257 | 0,0143 | 2,95 | 0,2257 | 0,0225 |
| A01- | Salzburg Bergheim-West | Salzburg Nord | 0,32 | 0,0318 | 0,0011 | 0,32 | 0,0318 | 0,0017 | 0,45 | 0,0445 | 0,0026 | 0,45 | 0,0445 | 0,0040 | 0,66 | 0,0509 | 0,0032 | 0,66 | 0,0509 | 0,0051 |
| A01- | Messe | Salzburg Bergheim-West | 0,15 | 0,0152 | 0,0005 | 0,15 | 0,0152 | 0,0008 | 0,22 | 0,0213 | 0,0012 | 0,22 | 0,0213 | 0,0019 | 0,32 | 0,0244 | 0,0015 | 0,32 | 0,0244 | 0,0024 |
| A01- | Salzburg Mitte Freilassing | Messe | 0,21 | 0,0203 | 0,0007 | 0,21 | 0,0203 | 0,0011 | 0,29 | 0,0284 | 0,0016 | 0,29 | 0,0284 | 0,0026 | 0,42 | 0,0324 | 0,0021 | 0,42 | 0,0324 | 0,0032 |
| A01- | Kleßheim | Salzburg Mitte Freilassing | 0,25 | 0,0249 | 0,0009 | 0,25 | 0,0249 | 0,0014 | 0,35 | 0,0348 | 0,0020 | 0,36 | 0,0348 | 0,0031 | 0,52 | 0,0398 | 0,0025 | 0,52 | 0,0398 | 0,0040 |
| A01- | Siezenheim | Kleßheim | 0,35 | 0,0345 | 0,0012 | 0,35 | 0,0345 | 0,0019 | 0,49 | 0,0482 | 0,0028 | 0,49 | 0,0482 | 0,0044 | 0,72 | 0,0551 | 0,0035 | 0,72 | 0,0551 | 0,0055 |
| A01- | Flughafen | Siezenheim | 0,18 | 0,0173 | 0,0006 | 0,18 | 0,0173 | 0,0010 | 0,25 | 0,0242 | 0,0014 | 0,25 | 0,0242 | 0,0022 | 0,36 | 0,0277 | 0,0018 | 0,36 | 0,0277 | 0,0028 |
| A01- | Wals Salzburg West | Flughafen | 0,21 | 0,0212 | 0,0007 | 0,22 | 0,0212 | 0,0012 | 0,30 | 0,0297 | 0,0017 | 0,30 | 0,0297 | 0,0027 | 0,44 | 0,0339 | 0,0021 | 0,44 | 0,0339 | 0,0034 |
| A01- | KN Salzburg | Wals Salzburg West | 0,32 | 0,0317 | 0,0011 | 0,32 | 0,0317 | 0,0017 | 0,45 | 0,0444 | 0,0026 | 0,45 | 0,0444 | 0,0040 | 0,66 | 0,0507 | 0,0032 | 0,66 | 0,0507 | 0,0051 |
| A01- | Staatsgrenze Walsberg | KN Salzburg | 0,55 | 0,0539 | 0,0019 | 0,55 | 0,0539 | 0,0030 | 0,77 | 0,0754 | 0,0043 | 0,77 | 0,0754 | 0,0068 | 1,12 | 0,0862 | 0,0055 | 1,13 | 0,0862 | 0,0086 |
| A02- | KN Vösendorf | KN Wien Inzersdorf | 0,68 | 0,0674 | 0,0024 | 0,69 | 0,0674 | 0,0037 | 0,96 | 0,0944 | 0,0054 | 0,96 | 0,0944 | 0,0085 | 1,40 | 0,1078 | 0,0068 | 1,41 | 0,1078 | 0,0108 |
| A02- | Mödling | KN Vösendorf | 0,46 | 0,0458 | 0,0016 | 0,47 | 0,0458 | 0,0025 | 0,65 | 0,0641 | 0,0037 | 0,65 | 0,0641 | 0,0058 | 0,95 | 0,0733 | 0,0047 | 0,96 | 0,0733 | 0,0073 |
| A02- | Wr. Neudorf | Mödling | 0,44 | 0,0437 | 0,0015 | 0,44 | 0,0437 | 0,0024 | 0,62 | 0,0612 | 0,0035 | 0,62 | 0,0612 | 0,0055 | 0,91 | 0,0700 | 0,0044 | 0,91 | 0,0700 | 0,0070 |
| A02- | Wr. Neudorf IZ/Süd | Wr. Neudorf | 0,49 | 0,0481 | 0,0017 | 0,49 | 0,0481 | 0,0026 | 0,68 | 0,0673 | 0,0039 | 0,69 | 0,0673 | 0,0061 | 1,00 | 0,0770 | 0,0049 | 1,00 | 0,0770 | 0,0077 |
| A02- | KN Guntramsdorf | Wr. Neudorf IZ/Süd | 0,71 | 0,0701 | 0,0025 | 0,71 | 0,0701 | 0,0039 | 1,00 | 0,0982 | 0,0056 | 1,00 | 0,0982 | 0,0089 | 1,46 | 0,1122 | 0,0071 | 1,46 | 0,1122 | 0,0112 |
| A02- | Traiskirchen | KN Guntramsdorf | 0,79 | 0,0781 | 0,0027 | 0,79 | 0,0781 | 0,0043 | 1,11 | 0,1093 | 0,0063 | 1,12 | 0,1093 | 0,0099 | 1,63 | 0,1249 | 0,0079 | 1,63 | 0,1249 | 0,0125 |
| A02- | Baden | Traiskirchen | 0,44 | 0,0435 | 0,0015 | 0,44 | 0,0435 | 0,0024 | 0,62 | 0,0608 | 0,0035 | 0,62 | 0,0608 | 0,0055 | 0,91 | 0,0695 | 0,0044 | 0,91 | 0,0695 | 0,0069 |
| A02- | Bad Vöslau | Baden | 0,72 | 0,0714 | 0,0025 | 0,73 | 0,0714 | 0,0039 | 1,02 | 0,1000 | 0,0057 | 1,02 | 0,1000 | 0,0090 | 1,49 | 0,1142 | 0,0072 | 1,49 | 0,1142 | 0,0114 |
| A02- | Kottingbrunn | Bad Vöslau | 0,52 | 0,0516 | 0,0018 | 0,52 | 0,0516 | 0,0028 | 0,73 | 0,0722 | 0,0042 | 0,74 | 0,0722 | 0,0065 | 1,07 | 0,0825 | 0,0052 | 1,08 | 0,0825 | 0,0082 |
| A02- | Leobersdorf | Kottingbrunn | 0,46 | 0,0452 | 0,0016 | 0,46 | 0,0452 | 0,0025 | 0,64 | 0,0633 | 0,0036 | 0,65 | 0,0633 | 0,0057 | 0,94 | 0,0724 | 0,0046 | 0,95 | 0,0724 | 0,0072 |
| A02- | Wöllersdorf | Leobersdorf | 1,83 | 0,1805 | 0,0063 | 1,83 | 0,1805 | 0,0099 | 2,57 | 0,2527 | 0,0145 | 2,58 | 0,2527 | 0,0228 | 3,76 | 0,2888 | 0,0183 | 3,77 | 0,2888 | 0,0288 |
| A02- | Wr. Neustadt West | Wöllersdorf | 1,19 | 0,1172 | 0,0041 | 1,19 | 0,1172 | 0,0064 | 1,67 | 0,1641 | 0,0094 | 1,67 | 0,1641 | 0,0148 | 2,44 | 0,1876 | 0,0119 | 2,45 | 0,1876 | 0,0187 |
| A02- | KN Wr. Neustadt | Wr. Neustadt West | 0,48 | 0,0469 | 0,0016 | 0,48 | 0,0469 | 0,0026 | 0,67 | 0,0657 | 0,0038 | 0,67 | 0,0657 | 0,0059 | 0,98 | 0,0751 | 0,0048 | 0,98 | 0,0751 | 0,0075 |
| A02- | KN Seebenstein | KN Wr. Neustadt | 2,15 | 0,2124 | 0,0074 | 2,16 | 0,2124 | 0,0117 | 3,02 | 0,2974 | 0,0171 | 3,03 | 0,2974 | 0,0269 | 4,42 | 0,3398 | 0,0216 | 4,44 | 0,3398 | 0,0339 |
| A02- | Grimmenstein | KN Seebenstein | 1,84 | 0,1812 | 0,0063 | 1,84 | 0,1812 | 0,0100 | 2,58 | 0,2537 | 0,0146 | 2,59 | 0,2537 | 0,0229 | 3,77 | 0,2899 | 0,0184 | 3,79 | 0,2899 | 0,0289 |
| A02- | Edlitz | Grimmenstein | 0,51 | 0,0502 | 0,0018 | 0,51 | 0,0502 | 0,0028 | 0,71 | 0,0702 | 0,0040 | 0,72 | 0,0702 | 0,0063 | 1,05 | 0,0803 | 0,0051 | 1,05 | 0,0803 | 0,0080 |
| A02- | Krumbach | Edlitz | 1,57 | 0,1549 | 0,0054 | 1,57 | 0,1549 | 0,0085 | 2,21 | 0,2169 | 0,0125 | 2,21 | 0,2169 | 0,0196 | 3,23 | 0,2478 | 0,0157 | 3,24 | 0,2478 | 0,0247 |
| A02- | Zöbern | Krumbach | 0,83 | 0,0818 | 0,0029 | 0,83 | 0,0818 | 0,0045 | 1,16 | 0,1145 | 0,0066 | 1,17 | 0,1145 | 0,0103 | 1,70 | 0,1308 | 0,0083 | 1,71 | 0,1308 | 0,0130 |
| A02- | Aspang | Zöbern | 0,11 | 0,0107 | 0,0004 | 0,11 | 0,0107 | 0,0006 | 0,15 | 0,0150 | 0,0009 | 0,15 | 0,0150 | 0,0014 | 0,22 | 0,0171 | 0,0011 | 0,22 | 0,0171 | 0,0017 |
| A02- | Schäffern | Aspang | 1,31 | 0,1294 | 0,0045 | 1,32 | 0,1294 | 0,0071 | 1,84 | 0,1811 | 0,0104 | 1,85 | 0,1811 | 0,0164 | 2,70 | 0,2070 | 0,0131 | 2,70 | 0,2070 | 0,0206 |
| A02- | Pinggau/Friedberg | Schäffern | 1,57 | 0,1545 | 0,0054 | 1,57 | 0,1545 | 0,0085 | 2,20 | 0,2164 | 0,0124 | 2,21 | 0,2164 | 0,0195 | 3,22 | 0,2473 | 0,0157 | 3,23 | 0,2473 | 0,0246 |
| A02- | Pinkafeld | Pinggau/Friedberg | 1,06 | 0,1047 | 0,0037 | 1,06 | 0,1047 | 0,0058 | 1,49 | 0,1466 | 0,0084 | 1,49 | 0,1466 | 0,0132 | 2,18 | 0,1675 | 0,0106 | 2,19 | 0,1675 | 0,0167 |
| A02- | Lafnitzal/Oberwart | Pinkafeld | 2,21 | 0,2182 | 0,0076 | 2,22 | 0,2182 | 0,0120 | 3,11 | 0,3055 | 0,0176 | 3,12 | 0,3055 | 0,0276 | 4,55 | 0,3492 | 0,0221 | 4,56 | 0,3492 | 0,0348 |
| A02- | Hartberg | Lafnitzal/Oberwart | 0,87 | 0,0861 | 0,0030 | 0,88 | 0,0861 | 0,0047 | 1,23 | 0,1206 | 0,0069 | 1,23 | 0,1206 | 0,0109 | 1,79 | 0,1378 | 0,0087 | 1,80 | 0,1378 | 0,0137 |
| A02- | Sebersdorf/Bad Waltersdorf | Hartberg | 2,21 | 0,2180 | 0,0076 | 2,22 | 0,2180 | 0,0120 | 3,10 | 0,3051 | 0,0175 | 3,11 | 0,3051 | 0,0276 | 4,54 | 0,3487 | 0,0221 | 4,55 | 0,3487 | 0,0348 |
| A02- | Ilz Fürstenfeld | Sebersdorf/Bad Waltersdorf | 2,48 | 0,2444 | 0,0086 | 2,48 | 0,2444 | 0,0134 | 3,48 | 0,3421 | 0,0197 | 3,49 | 0,3421 | 0,0309 | 5,09 | 0,3910 | 0,0248 | 5,11 | 0,3910 | 0,0390 |
| A02- | Sinabelkirchen | Ilz Fürstenfeld | 2,28 | 0,2247 | 0,0079 | 2,28 | 0,2247 | 0,0124 | 3,20 | 0,3145 | 0,0181 | 3,21 | 0,3145 | 0,0284 | 4,68 | 0,3595 | 0,0228 | 4,69 | 0,3595 | 0,0358 |
| A02- | Gleisdorf Süd | Sinabelkirchen | 1,50 | 0,1480 | 0,0052 | 1,50 | 0,1480 | 0,0081 | 2,11 | 0,2072 | 0,0119 | 2,11 | 0,2072 | 0,0187 | 3,08 | 0,2368 | 0,0150 | 3,09 | 0,2368 | 0,0236 |
| A02- | Gleisdorf West | Gleisdorf Süd | 0,65 | 0,0642 | 0,0022 | 0,65 | 0,0642 | 0,0035 | 0,91 | 0,0899 | 0,0052 | 0,92 | 0,0899 | 0,0081 | 1,34 | 0,1028 | 0,0065 | 1,34 | 0,1028 | 0,0102 |
| A02- | Laßnitzhöhe | Gleisdorf West | 1,71 | 0,1683 | 0,0059 | 1,71 | 0,1683 | 0,0093 | 2,40 | 0,2356 | 0,0135 | 2,40 | 0,2356 | 0,0213 | 3,51 | 0,2693 | 0,0171 | 3,52 | 0,2693 | 0,0268 |
| A02- | KN Graz Ost | Laßnitzhöhe | 2,14 | 0,2106 | 0,0074 | 2,14 | 0,2106 | 0,0116 | 3,00 | 0,2948 | 0,0170 | 3,01 | 0,2948 | 0,0266 | 4,39 | 0,3369 | 0,0214 | 4,40 | 0,3369 | 0,0336 |
| A02- | Graz Feldkirchen Flughafen | KN Graz Ost | 0,77 | 0,0758 | 0,0027 | 0,77 | 0,0758 | 0,0042 | 1,08 | 0,1061 | 0,0061 | 1,08 | 0,1061 | 0,0096 | 1,58 | 0,1212 | 0,0077 | 1,58 | 0,1212 | 0,0121 |
| A02- | KN Graz West | Graz Feldkirchen Flughafen | 0,51 | 0,0507 | 0,0018 | 0,52 | 0,0507 | 0,0028 | 0,72 | 0,0710 | 0,0041 | 0,72 | 0,0710 | 0,0064 | 1,06 | 0,0812 | 0,0051 | 1,06 | 0,0812 | 0,0081 |
| A02- | Unterpremstätten | KN Graz West | 0,62 | 0,0610 | 0,0021 | 0,62 | 0,0610 | 0,0034 | 0,87 | 0,0854 | 0,0049 | 0,87 | 0,0854 | 0,0077 | 1,27 | 0,0976 | 0,0062 | 1,27 | 0,0976 | 0,0097 |
| A02- | Lieboch | Unterpremstätten | 0,96 | 0,0947 | 0,0033 | 0,96 | 0,0947 | 0,0052 | 1,35 | 0,1326 | 0,0076 | 1,35 | 0,1326 | 0,0120 | 1,97 | 0,1515 | 0,0096 | 1,98 | 0,1515 | 0,0151 |
| A02- | Mooskirchen | Lieboch | 1,32 | 0,1306 | 0,0046 | 1,33 | 0,1306 | 0,0072 | 1,86 | 0,1828 | 0,0105 | 1,86 | 0,1828 | 0,0165 | 2,72 | 0,2089 | 0,0133 | 2,73 | 0,2089 | 0,0208 |
| A02- | Steinberg | Mooskirchen | 1,37 | 0,1351 | 0,0047 | 1,37 | 0,1351 | 0,0074 | 1,92 | 0,1892 | 0,0109 | 1,93 | 0,1892 | 0,0171 | 2,82 | 0,2162 | 0,0137 | 2,82 | 0,2162 | 0,0216 |
| A02- | Modriach | Steinberg | 3,43 | 0,3378 | 0,0118 | 3,43 | 0,3378 | 0,0186 | 4,81 | 0,4729 | 0,0272 | 4,82 | | | | | | | | |

| | | | | | | | | | | | | | | | | | | | | |
|------|----------------------------------|----------------------------------|------|--------|--------|------|--------|--------|------|--------|--------|------|--------|--------|------|--------|--------|------|----------|--------|
| A02- | Velden West | Velden Ost | 0,76 | 0,0747 | 0,0026 | 0,76 | 0,0747 | 0,0041 | 1,06 | 0,1045 | 0,0060 | 1,07 | 0,1045 | 0,0094 | 1,56 | 0,1195 | 0,0076 | 1,56 | 0,1195 | 0,0119 |
| A02- | Wernberg | Velden West | 1,25 | 0,1234 | 0,0043 | 1,25 | 0,1234 | 0,0068 | 1,76 | 0,1728 | 0,0099 | 1,76 | 0,1728 | 0,0156 | 2,57 | 0,1974 | 0,0125 | 2,58 | 0,1974 | 0,0197 |
| A02- | KN Villach | Wernberg | 0,67 | 0,0656 | 0,0023 | 0,67 | 0,0656 | 0,0036 | 0,93 | 0,0918 | 0,0053 | 0,94 | 0,0918 | 0,0083 | 1,37 | 0,1050 | 0,0067 | 1,37 | 0,1050 | 0,0105 |
| A02- | Villach Faaker See | KN Villach | 0,52 | 0,0510 | 0,0018 | 0,52 | 0,0510 | 0,0028 | 0,73 | 0,0714 | 0,0041 | 0,73 | 0,0714 | 0,0065 | 1,06 | 0,0816 | 0,0052 | 1,07 | 0,0816 | 0,0081 |
| A02- | Villach Warmbad | Villach Faaker See | 1,18 | 0,1165 | 0,0041 | 1,18 | 0,1165 | 0,0064 | 1,66 | 0,1631 | 0,0094 | 1,66 | 0,1631 | 0,0147 | 2,43 | 0,1864 | 0,0118 | 2,43 | 0,1864 | 0,0186 |
| A02- | Hermagor | Villach Warmbad | 2,14 | 0,2112 | 0,0074 | 2,15 | 0,2112 | 0,0116 | 3,01 | 0,2957 | 0,0170 | 3,02 | 0,2957 | 0,0267 | 4,40 | 0,3379 | 0,0214 | 4,41 | 0,3379 | 0,0337 |
| A02- | Arnoldstein | Hermagor | 0,51 | 0,0503 | 0,0018 | 0,51 | 0,0503 | 0,0028 | 0,72 | 0,0704 | 0,0040 | 0,72 | 0,0704 | 0,0064 | 1,05 | 0,0805 | 0,0051 | 1,05 | 0,0805 | 0,0080 |
| A02- | Staatsgrenze Arnoldstein | Arnoldstein | 0,78 | 0,0771 | 0,0027 | 0,78 | 0,0771 | 0,0042 | 1,10 | 0,1080 | 0,0062 | 1,10 | 0,1080 | 0,0098 | 1,61 | 0,1234 | 0,0078 | 1,61 | 0,1234 | 0,0123 |
| A03- | Münchendorf/Achau | KN Guntramsdorf | 0,20 | 0,0200 | 0,0007 | 0,20 | 0,0200 | 0,0011 | 0,28 | 0,0280 | 0,0016 | 0,29 | 0,0280 | 0,0025 | 0,42 | 0,0320 | 0,0020 | 0,42 | 0,0320 | 0,0032 |
| A03- | Ebreichsdorf Nord | Münchendorf/Achau | 0,86 | 0,0843 | 0,0029 | 0,86 | 0,0843 | 0,0046 | 1,20 | 0,1180 | 0,0068 | 1,20 | 0,1180 | 0,0107 | 1,76 | 0,1348 | 0,0086 | 1,76 | 0,1348 | 0,0134 |
| A03- | Ebreichsdorf West | Ebreichsdorf Nord | 0,70 | 0,0688 | 0,0024 | 0,70 | 0,0688 | 0,0038 | 0,98 | 0,0963 | 0,0055 | 0,98 | 0,0963 | 0,0087 | 1,43 | 0,1101 | 0,0070 | 1,44 | 0,1101 | 0,0110 |
| A03- | Pottendorf | Ebreichsdorf West | 0,92 | 0,0903 | 0,0032 | 0,92 | 0,0903 | 0,0050 | 1,28 | 0,1264 | 0,0073 | 1,29 | 0,1264 | 0,0114 | 1,88 | 0,1444 | 0,0092 | 1,89 | 0,1444 | 0,0144 |
| A03- | Hornstein | Pottendorf | 1,50 | 0,1482 | 0,0052 | 1,51 | 0,1482 | 0,0082 | 2,11 | 0,2075 | 0,0119 | 2,12 | 0,2075 | 0,0187 | 3,09 | 0,2371 | 0,0150 | 3,10 | 0,2371 | 0,0236 |
| A03- | Müllendorf | Hornstein | 0,99 | 0,0971 | 0,0034 | 0,99 | 0,0971 | 0,0053 | 1,38 | 0,1360 | 0,0078 | 1,39 | 0,1360 | 0,0123 | 2,02 | 0,1554 | 0,0099 | 2,03 | 0,1554 | 0,0155 |
| A03- | KN Eisenstadt | Müllendorf | 0,82 | 0,0812 | 0,0028 | 0,83 | 0,0812 | 0,0045 | 1,16 | 0,1137 | 0,0065 | 1,16 | 0,1137 | 0,0103 | 1,69 | 0,1299 | 0,0082 | 1,70 | 0,1299 | 0,0129 |
| A031 | Siegendorf | KN Eisenstadt | 0,65 | 0,0640 | 0,0022 | 0,65 | 0,0640 | 0,0035 | 0,91 | 0,0896 | 0,0052 | 0,91 | 0,0896 | 0,0081 | 1,33 | 0,1024 | 0,0065 | 1,34 | 0,1024 | 0,0102 |
| A041 | KN Wien Prater | Stadionbrücke | 0,12 | 0,0118 | 0,0004 | 0,12 | 0,0118 | 0,0006 | 0,17 | 0,0165 | 0,0009 | 0,17 | 0,0165 | 0,0015 | 0,25 | 0,0188 | 0,0012 | 0,25 | 0,0188 | 0,0019 |
| A04- | Wien Simmeringer Haide | KN Wien Prater | 0,82 | 0,0811 | 0,0028 | 0,82 | 0,0811 | 0,0045 | 1,15 | 0,1135 | 0,0065 | 1,16 | 0,1135 | 0,0103 | 1,69 | 0,1298 | 0,0082 | 1,69 | 0,1298 | 0,0129 |
| A04- | KN Schwechat | Wien Simmeringer Haide | 0,74 | 0,0728 | 0,0025 | 0,74 | 0,0728 | 0,0040 | 1,04 | 0,1019 | 0,0059 | 1,04 | 0,1019 | 0,0092 | 1,52 | 0,1165 | 0,0074 | 1,52 | 0,1165 | 0,0116 |
| A04- | Flughafen Wien Schwechat | KN Schwechat | 1,07 | 0,1052 | 0,0037 | 1,07 | 0,1052 | 0,0058 | 1,50 | 0,1472 | 0,0085 | 1,50 | 0,1472 | 0,0133 | 2,19 | 0,1683 | 0,0107 | 2,20 | 0,1683 | 0,0168 |
| A04- | Fischamend | Flughafen Wien Schwechat | 1,19 | 0,1177 | 0,0041 | 1,20 | 0,1177 | 0,0065 | 1,68 | 0,1648 | 0,0095 | 1,68 | 0,1648 | 0,0149 | 2,45 | 0,1884 | 0,0120 | 2,46 | 0,1884 | 0,0188 |
| A04- | Bruck/Leitha West | Fischamend | 2,62 | 0,2582 | 0,0090 | 2,62 | 0,2582 | 0,0142 | 3,68 | 0,3615 | 0,0208 | 3,69 | 0,3615 | 0,0327 | 5,38 | 0,4132 | 0,0262 | 5,39 | 0,4132 | 0,0412 |
| A04- | Bruck/Leitha Ost | Bruck/Leitha West | 0,87 | 0,0858 | 0,0030 | 0,87 | 0,0858 | 0,0047 | 1,22 | 0,1201 | 0,0069 | 1,22 | 0,1201 | 0,0108 | 1,79 | 0,1372 | 0,0087 | 1,79 | 0,1372 | 0,0137 |
| A04- | KN Bruckneudorf | Bruck/Leitha Ost | 0,54 | 0,0535 | 0,0019 | 0,54 | 0,0535 | 0,0029 | 0,76 | 0,0749 | 0,0043 | 0,76 | 0,0749 | 0,0068 | 1,11 | 0,0856 | 0,0054 | 1,12 | 0,0856 | 0,0085 |
| A04- | Parndorf | KN Bruckneudorf | 0,35 | 0,0344 | 0,0012 | 0,35 | 0,0344 | 0,0019 | 0,49 | 0,0482 | 0,0028 | 0,49 | 0,0482 | 0,0044 | 0,72 | 0,0551 | 0,0035 | 0,72 | 0,0551 | 0,0055 |
| A04- | Neusiedl | Parndorf | 0,68 | 0,0666 | 0,0023 | 0,68 | 0,0666 | 0,0037 | 0,95 | 0,0932 | 0,0054 | 0,95 | 0,0932 | 0,0084 | 1,39 | 0,1066 | 0,0068 | 1,39 | 0,1066 | 0,0106 |
| A04- | Neusiedl/Gewerbepark | Neusiedl | 0,16 | 0,0154 | 0,0005 | 0,16 | 0,0154 | 0,0008 | 0,22 | 0,0216 | 0,0012 | 0,22 | 0,0216 | 0,0020 | 0,32 | 0,0247 | 0,0016 | 0,32 | 0,0247 | 0,0025 |
| A04- | Weiden/Gols | Neusiedl/Gewerbepark | 1,40 | 0,1381 | 0,0048 | 1,40 | 0,1381 | 0,0076 | 1,97 | 0,1934 | 0,0111 | 1,97 | 0,1934 | 0,0175 | 2,88 | 0,2210 | 0,0140 | 2,89 | 0,2210 | 0,0220 |
| A04- | Mönchhof | Weiden/Gols | 1,02 | 0,1008 | 0,0035 | 1,02 | 0,1008 | 0,0055 | 1,43 | 0,1411 | 0,0081 | 1,44 | 0,1411 | 0,0127 | 2,10 | 0,1612 | 0,0102 | 2,10 | 0,1612 | 0,0161 |
| A04- | Nickelsdorf | Mönchhof | 1,60 | 0,1579 | 0,0055 | 1,60 | 0,1579 | 0,0087 | 2,25 | 0,2210 | 0,0127 | 2,25 | 0,2210 | 0,0200 | 3,29 | 0,2526 | 0,0160 | 3,30 | 0,2526 | 0,0252 |
| A04- | Staatsgrenze Nickelsdorf | Nickelsdorf | 0,28 | 0,0280 | 0,0010 | 0,28 | 0,0280 | 0,0015 | 0,40 | 0,0391 | 0,0023 | 0,40 | 0,0391 | 0,0035 | 0,58 | 0,0447 | 0,0028 | 0,58 | 0,0447 | 0,0045 |
| A05- | Wolkersdorf Süd | KN Eibesbrunn | 0,55 | 0,0544 | 0,0019 | 0,55 | 0,0544 | 0,0030 | 0,77 | 0,0762 | 0,0044 | 0,78 | 0,0762 | 0,0069 | 1,13 | 0,0871 | 0,0055 | 1,14 | 0,0871 | 0,0087 |
| A05- | Ulrichskirchen | Wolkersdorf Süd | 0,60 | 0,0589 | 0,0021 | 0,60 | 0,0589 | 0,0032 | 0,84 | 0,0824 | 0,0047 | 0,84 | 0,0824 | 0,0074 | 1,23 | 0,0942 | 0,0060 | 1,23 | 0,0942 | 0,0094 |
| A05- | Wolkersdorf Nord | Ulrichskirchen | 0,39 | 0,0385 | 0,0013 | 0,39 | 0,0385 | 0,0021 | 0,55 | 0,0538 | 0,0031 | 0,55 | 0,0538 | 0,0049 | 0,80 | 0,0615 | 0,0039 | 0,80 | 0,0615 | 0,0061 |
| A05- | Hochleithen | Wolkersdorf Nord | 0,70 | 0,0690 | 0,0024 | 0,70 | 0,0690 | 0,0038 | 0,98 | 0,0966 | 0,0056 | 0,99 | 0,0966 | 0,0087 | 1,44 | 0,1104 | 0,0070 | 1,44 | 0,1104 | 0,0110 |
| A05- | Gaweinstal Mitte | Hochleithen | 1,40 | 0,1380 | 0,0048 | 1,40 | 0,1380 | 0,0076 | 1,97 | 0,1933 | 0,0111 | 1,97 | 0,1933 | 0,0175 | 2,88 | 0,2209 | 0,0140 | 2,88 | 0,2209 | 0,0220 |
| A05- | Gaweinstal Nord | Gaweinstal Mitte | 0,37 | 0,0365 | 0,0013 | 0,37 | 0,0365 | 0,0020 | 0,52 | 0,0511 | 0,0029 | 0,52 | 0,0511 | 0,0046 | 0,76 | 0,0584 | 0,0037 | 0,76 | 0,0584 | 0,0058 |
| A05- | Mistelbach Süd | Gaweinstal Nord | 0,64 | 0,0630 | 0,0022 | 0,64 | 0,0630 | 0,0035 | 0,90 | 0,0883 | 0,0051 | 0,90 | 0,0883 | 0,0080 | 1,31 | 0,1009 | 0,0064 | 1,32 | 0,1009 | 0,0101 |
| A05- | Mistelbach Ost / Wilfersdorf | Mistelbach Süd | 1,07 | 0,1058 | 0,0037 | 1,08 | 0,1058 | 0,0058 | 1,51 | 0,1481 | 0,0085 | 1,51 | 0,1481 | 0,0134 | 2,20 | 0,1693 | 0,0107 | 2,21 | 0,1693 | 0,0169 |
| A05- | Poysdorf Süd | Mistelbach Ost / Wilfersdorf | 1,08 | 0,1068 | 0,0037 | 1,09 | 0,1068 | 0,0059 | 1,52 | 0,1496 | 0,0086 | 1,53 | 0,1496 | 0,0135 | 2,23 | 0,1709 | 0,0108 | 2,23 | 0,1709 | 0,0170 |
| A05- | Großkrut | Poysdorf Süd | 1,43 | 0,1409 | 0,0049 | 1,43 | 0,1409 | 0,0077 | 2,01 | 0,1973 | 0,0113 | 2,01 | 0,1973 | 0,0178 | 2,94 | 0,2254 | 0,0143 | 2,94 | 0,2254 | 0,0225 |
| A05- | Poysdorf Nord | Großkrut | 1,39 | 0,1371 | 0,0048 | 1,39 | 0,1371 | 0,0075 | 1,95 | 0,1919 | 0,0110 | 1,96 | 0,1919 | 0,0173 | 2,86 | 0,2193 | 0,0139 | 2,86 | 0,2193 | 0,0219 |
| A06- | Potzneusiedl | KN Bruckneudorf | 1,76 | 0,1736 | 0,0061 | 1,76 | 0,1736 | 0,0095 | 2,47 | 0,2431 | 0,0140 | 2,48 | 0,2431 | 0,0220 | 3,62 | 0,2778 | 0,0176 | 3,63 | 0,2778 | 0,0277 |
| A06- | Gattendorf | Potzneusiedl | 0,76 | 0,0754 | 0,0026 | 0,77 | 0,0754 | 0,0041 | 1,07 | 0,1055 | 0,0061 | 1,08 | 0,1055 | 0,0095 | 1,57 | 0,1206 | 0,0076 | 1,57 | 0,1206 | 0,0120 |
| A06- | Kitzsee | Gattendorf | 1,28 | 0,1260 | 0,0044 | 1,28 | 0,1260 | 0,0069 | 1,79 | 0,1765 | 0,0101 | 1,80 | 0,1765 | 0,0159 | 2,63 | 0,2017 | 0,0128 | 2,63 | 0,2017 | 0,0201 |
| A06- | Staatsgrenze Kitzsee | Kitzsee | 0,65 | 0,0640 | 0,0022 | 0,65 | 0,0640 | 0,0035 | 0,91 | 0,0896 | 0,0052 | 0,91 | 0,0896 | 0,0081 | 1,33 | 0,1024 | 0,0065 | 1,34 | 0,1024 | 0,0102 |
| A07- | Linz Franzosenhausweg | KN Linz | 0,46 | 0,0452 | 0,0016 | 0,46 | 0,0452 | 0,0025 | 0,64 | 0,0632 | 0,0036 | 0,64 | 0,0632 | 0,0057 | 0,94 | 0,0723 | 0,0046 | 0,94 | 0,0723 | 0,0072 |
| A07- | Linz Salzburger Straße Neue Welt | Linz Franzosenhausweg | 0,40 | 0,0394 | 0,0014 | 0,40 | 0,0394 | 0,0022 | 0,56 | 0,0552 | 0,0032 | 0,56 | 0,0552 | 0,0050 | 0,82 | 0,0631 | 0,0040 | 0,82 | 0,0631 | 0,0063 |
| A07- | Muldenstraße Bindermichl | Linz Salzburger Straße Neue Welt | 0,28 | 0,0274 | 0,0010 | 0,28 | 0,0274 | 0,0015 | 0,39 | 0,0383 | 0,0022 | 0,39 | 0,0383 | 0,0035 | 0,57 | 0,0438 | 0,0028 | 0,57 | 0,0438 | 0,0044 |
| A07- | Leonding Linz Zentrum | Muldenstraße Bindermichl | 0,13 | 0,0133 | 0,0005 | 0,14 | 0,0133 | 0,0007 | 0,19 | 0,0186 | 0,0011 | 0,19 | 0,0186 | 0,0017 | 0,28 | 0,0212 | 0,0013 | 0,28 | 0,0212 | 0,0021 |
| A07- | Linz Wiener Straße | Leonding Linz Zentrum | 0,19 | 0,0187 | 0,0007 | 0,19 | 0,0187 | 0,0010 | 0,27 | 0,0262 | 0,0015 | 0,27 | 0,0262 | 0,0024 | 0,39 | 0,0299 | 0,0019 | 0,39 | 0,0299</ | |

| | | | | | | | | | | | | | | | | | | | | |
|------|---|--------------------------------------|-------|--------|--------|-------|--------|--------|-------|--------|--------|-------|--------|--------|-------|--------|--------|-------|--------|--------|
| A08- | Staatsgrenze Suben | Schärding Suben | 0,45 | 0,0446 | 0,0016 | 0,45 | 0,0446 | 0,0025 | 0,64 | 0,0625 | 0,0036 | 0,64 | 0,0625 | 0,0056 | 0,93 | 0,0714 | 0,0045 | 0,93 | 0,0714 | 0,0071 |
| A09- | Ried im Traunkreis | KN Voralpenkreuz | 1,12 | 0,1100 | 0,0039 | 1,12 | 0,1100 | 0,0061 | 1,57 | 0,1540 | 0,0089 | 1,57 | 0,1540 | 0,0139 | 2,29 | 0,1760 | 0,0112 | 2,30 | 0,1760 | 0,0175 |
| A09- | Inzersdorf Kirchdorf | Ried im Traunkreis | 2,09 | 0,2064 | 0,0072 | 2,10 | 0,2064 | 0,0114 | 2,94 | 0,2889 | 0,0166 | 2,95 | 0,2889 | 0,0261 | 4,30 | 0,3302 | 0,0209 | 4,31 | 0,3302 | 0,0329 |
| A09- | Klaus | Inzersdorf Kirchdorf | 2,55 | 0,2514 | 0,0088 | 2,56 | 0,2514 | 0,0138 | 3,58 | 0,3520 | 0,0202 | 3,59 | 0,3520 | 0,0318 | 5,24 | 0,4022 | 0,0255 | 5,25 | 0,4022 | 0,0401 |
| A09- | St. Pankratz | Klaus | 1,62 | 0,1598 | 0,0056 | 1,62 | 0,1598 | 0,0088 | 2,27 | 0,2237 | 0,0129 | 2,28 | 0,2237 | 0,0202 | 3,33 | 0,2557 | 0,0162 | 3,34 | 0,2557 | 0,0255 |
| A09- | Roßleiten Windischgarsten | St. Pankratz | 2,26 | 0,2230 | 0,0078 | 2,27 | 0,2230 | 0,0123 | 3,17 | 0,3121 | 0,0179 | 3,18 | 0,3121 | 0,0282 | 4,64 | 0,3567 | 0,0226 | 4,66 | 0,3567 | 0,0356 |
| A09- | Gleinkerau | Roßleiten Windischgarsten | 1,06 | 0,1048 | 0,0037 | 1,07 | 0,1048 | 0,0058 | 1,49 | 0,1467 | 0,0084 | 1,50 | 0,1467 | 0,0133 | 2,18 | 0,1677 | 0,0106 | 2,19 | 0,1677 | 0,0167 |
| A09- | Spital am Pyhrn | Gleinkerau | 0,80 | 0,0790 | 0,0028 | 0,80 | 0,0790 | 0,0043 | 1,12 | 0,1106 | 0,0064 | 1,13 | 0,1106 | 0,0100 | 1,65 | 0,1264 | 0,0080 | 1,65 | 0,1264 | 0,0126 |
| A09- | Ardning / Admont | Spital am Pyhrn | 4,33 | 0,2011 | 0,0070 | 4,34 | 0,2011 | 0,0111 | 6,07 | 0,2816 | 0,0162 | 6,08 | 0,2816 | 0,0254 | 9,00 | 0,3218 | 0,0204 | 9,02 | 0,3218 | 0,0321 |
| A09- | Liezen | Ardning / Admont | 0,47 | 0,0458 | 0,0016 | 0,47 | 0,0458 | 0,0025 | 0,65 | 0,0642 | 0,0037 | 0,65 | 0,0642 | 0,0058 | 0,96 | 0,0733 | 0,0047 | 0,96 | 0,0733 | 0,0073 |
| A09- | Rottenmann | Liezen | 0,97 | 0,0958 | 0,0034 | 0,97 | 0,0958 | 0,0053 | 1,36 | 0,1341 | 0,0077 | 1,37 | 0,1341 | 0,0121 | 2,00 | 0,1532 | 0,0097 | 2,00 | 0,1532 | 0,0153 |
| A09- | Trieben | Rottenmann | 2,42 | 0,2388 | 0,0084 | 2,43 | 0,2388 | 0,0131 | 3,40 | 0,3343 | 0,0192 | 3,41 | 0,3343 | 0,0302 | 4,97 | 0,3820 | 0,0242 | 4,99 | 0,3820 | 0,0381 |
| A09- | Treglwang | Trieben | 1,97 | 0,1941 | 0,0068 | 1,97 | 0,1941 | 0,0107 | 2,76 | 0,2718 | 0,0156 | 2,77 | 0,2718 | 0,0246 | 4,04 | 0,3106 | 0,0197 | 4,06 | 0,3106 | 0,0310 |
| A09- | Kalwang | Treglwang | 2,65 | 0,2609 | 0,0091 | 2,65 | 0,2609 | 0,0143 | 3,71 | 0,3653 | 0,0210 | 3,73 | 0,3653 | 0,0330 | 5,44 | 0,4174 | 0,0265 | 5,45 | 0,4174 | 0,0416 |
| A09- | Mautern | Kalwang | 1,23 | 0,1215 | 0,0043 | 1,23 | 0,1215 | 0,0067 | 1,73 | 0,1701 | 0,0098 | 1,73 | 0,1701 | 0,0154 | 2,53 | 0,1944 | 0,0123 | 2,54 | 0,1944 | 0,0194 |
| A09- | Kammern | Mautern | 1,39 | 0,1367 | 0,0048 | 1,39 | 0,1367 | 0,0075 | 1,95 | 0,1913 | 0,0110 | 1,95 | 0,1913 | 0,0173 | 2,85 | 0,2187 | 0,0139 | 2,85 | 0,2187 | 0,0218 |
| A09- | Traboch | Kammern | 1,45 | 0,1429 | 0,0050 | 1,45 | 0,1429 | 0,0079 | 2,03 | 0,2000 | 0,0115 | 2,04 | 0,2000 | 0,0181 | 2,98 | 0,2286 | 0,0145 | 2,98 | 0,2286 | 0,0228 |
| A09- | Terminal St. Michael | Traboch | 0,28 | 0,0281 | 0,0010 | 0,29 | 0,0281 | 0,0015 | 0,40 | 0,0393 | 0,0023 | 0,40 | 0,0393 | 0,0035 | 0,58 | 0,0449 | 0,0028 | 0,58 | 0,0449 | 0,0045 |
| A09- | KN St. Michael | Terminal St. Michael | 0,53 | 0,0526 | 0,0018 | 0,53 | 0,0526 | 0,0029 | 0,75 | 0,0736 | 0,0042 | 0,75 | 0,0736 | 0,0067 | 1,10 | 0,0842 | 0,0053 | 1,10 | 0,0842 | 0,0084 |
| A09- | Übelbach | KN St. Michael | 10,55 | 0,4899 | 0,0171 | 10,56 | 0,4899 | 0,0269 | 14,79 | 0,6858 | 0,0394 | 14,81 | 0,6858 | 0,0620 | 21,93 | 0,7838 | 0,0497 | 21,96 | 0,7838 | 0,0781 |
| A09- | KN Peggau Deutschefeistritz | Übelbach | 1,64 | 0,1620 | 0,0057 | 1,65 | 0,1620 | 0,0089 | 2,31 | 0,2268 | 0,0130 | 2,31 | 0,2268 | 0,0205 | 3,38 | 0,2592 | 0,0164 | 3,38 | 0,2592 | 0,0258 |
| A09- | Gratkorn Nord | KN Peggau Deutschefeistritz | 0,78 | 0,0768 | 0,0027 | 0,78 | 0,0768 | 0,0042 | 1,09 | 0,1075 | 0,0062 | 1,10 | 0,1075 | 0,0097 | 1,60 | 0,1228 | 0,0078 | 1,60 | 0,1228 | 0,0122 |
| A09- | Gratkorn Süd | Gratkorn Nord | 0,86 | 0,0843 | 0,0030 | 0,86 | 0,0843 | 0,0046 | 1,20 | 0,1180 | 0,0068 | 1,20 | 0,1180 | 0,0107 | 1,76 | 0,1349 | 0,0086 | 1,76 | 0,1349 | 0,0134 |
| A09- | Graz Nord | Gratkorn Süd | 0,19 | 0,0187 | 0,0007 | 0,19 | 0,0187 | 0,0010 | 0,27 | 0,0262 | 0,0015 | 0,27 | 0,0262 | 0,0024 | 0,39 | 0,0299 | 0,0019 | 0,39 | 0,0299 | 0,0030 |
| A09- | Graz Webling | Graz Nord | 2,17 | 0,2137 | 0,0075 | 2,17 | 0,2137 | 0,0118 | 3,04 | 0,2992 | 0,0172 | 3,05 | 0,2992 | 0,0270 | 4,45 | 0,3419 | 0,0217 | 4,46 | 0,3419 | 0,0341 |
| A09- | Seiersberg | Graz Webling | 0,58 | 0,0568 | 0,0020 | 0,58 | 0,0568 | 0,0031 | 0,81 | 0,0795 | 0,0046 | 0,81 | 0,0795 | 0,0072 | 1,18 | 0,0909 | 0,0058 | 1,19 | 0,0909 | 0,0091 |
| A09- | KN Graz West | Seiersberg | 0,28 | 0,0278 | 0,0010 | 0,28 | 0,0278 | 0,0015 | 0,40 | 0,0389 | 0,0022 | 0,40 | 0,0389 | 0,0035 | 0,58 | 0,0445 | 0,0028 | 0,58 | 0,0445 | 0,0044 |
| A09- | Schwarzlsee | KN Graz West | 0,28 | 0,0274 | 0,0010 | 0,28 | 0,0274 | 0,0015 | 0,39 | 0,0384 | 0,0022 | 0,39 | 0,0384 | 0,0035 | 0,57 | 0,0438 | 0,0028 | 0,57 | 0,0438 | 0,0044 |
| A09- | Schachenwald / IBC Businesscenter | Schwarzlsee | 0,31 | 0,0306 | 0,0011 | 0,31 | 0,0306 | 0,0017 | 0,44 | 0,0429 | 0,0025 | 0,44 | 0,0429 | 0,0039 | 0,64 | 0,0490 | 0,0031 | 0,64 | 0,0490 | 0,0049 |
| A09- | Kalsdorf | Schachenwald / IBC Businesscenter | 0,32 | 0,0312 | 0,0011 | 0,32 | 0,0312 | 0,0017 | 0,44 | 0,0436 | 0,0025 | 0,44 | 0,0436 | 0,0039 | 0,65 | 0,0499 | 0,0032 | 0,65 | 0,0499 | 0,0050 |
| A09- | Werndorf Terminal | Kalsdorf | 0,79 | 0,0780 | 0,0027 | 0,79 | 0,0780 | 0,0043 | 1,11 | 0,1092 | 0,0063 | 1,11 | 0,1092 | 0,0099 | 1,62 | 0,1248 | 0,0079 | 1,63 | 0,1248 | 0,0124 |
| A09- | Wildon | Werndorf Terminal | 0,88 | 0,0872 | 0,0031 | 0,89 | 0,0872 | 0,0048 | 1,24 | 0,1221 | 0,0070 | 1,25 | 0,1221 | 0,0110 | 1,82 | 0,1395 | 0,0088 | 1,82 | 0,1395 | 0,0139 |
| A09- | Hengsberg | Wildon | 0,43 | 0,0426 | 0,0015 | 0,43 | 0,0426 | 0,0023 | 0,61 | 0,0596 | 0,0034 | 0,61 | 0,0596 | 0,0054 | 0,89 | 0,0681 | 0,0043 | 0,89 | 0,0681 | 0,0068 |
| A09- | Lebring | Hengsberg | 0,76 | 0,0754 | 0,0026 | 0,77 | 0,0754 | 0,0041 | 1,07 | 0,1056 | 0,0061 | 1,08 | 0,1056 | 0,0095 | 1,57 | 0,1206 | 0,0077 | 1,58 | 0,1206 | 0,0120 |
| A09- | Leibnitz | Lebring | 1,32 | 0,1305 | 0,0046 | 1,33 | 0,1305 | 0,0072 | 1,86 | 0,1827 | 0,0105 | 1,86 | 0,1827 | 0,0165 | 2,72 | 0,2088 | 0,0132 | 2,73 | 0,2088 | 0,0208 |
| A09- | Vogau Straß | Leibnitz | 1,62 | 0,1596 | 0,0056 | 1,62 | 0,1596 | 0,0088 | 2,27 | 0,2235 | 0,0128 | 2,28 | 0,2235 | 0,0202 | 3,33 | 0,2554 | 0,0162 | 3,33 | 0,2554 | 0,0255 |
| A09- | Gersdorf | Vogau Straß | 0,79 | 0,0774 | 0,0027 | 0,79 | 0,0774 | 0,0043 | 1,10 | 0,1084 | 0,0062 | 1,11 | 0,1084 | 0,0098 | 1,61 | 0,1239 | 0,0079 | 1,62 | 0,1239 | 0,0123 |
| A09- | Spielfeld | Gersdorf | 0,41 | 0,0408 | 0,0014 | 0,41 | 0,0408 | 0,0022 | 0,58 | 0,0571 | 0,0033 | 0,58 | 0,0571 | 0,0052 | 0,85 | 0,0653 | 0,0041 | 0,85 | 0,0653 | 0,0065 |
| A09- | Staatsgrenze Spielfeld | Spielfeld | 0,38 | 0,0372 | 0,0013 | 0,38 | 0,0372 | 0,0020 | 0,53 | 0,0521 | 0,0030 | 0,53 | 0,0521 | 0,0047 | 0,78 | 0,0595 | 0,0038 | 0,78 | 0,0595 | 0,0059 |
| A10- | Salzburg Süd / Anif | KN Salzburg | 1,53 | 0,1505 | 0,0053 | 1,53 | 0,1505 | 0,0083 | 2,14 | 0,2107 | 0,0121 | 2,15 | 0,2107 | 0,0190 | 3,13 | 0,2408 | 0,0153 | 3,14 | 0,2408 | 0,0240 |
| A10- | Puch Urstein | Salzburg Süd / Anif | 0,52 | 0,0511 | 0,0018 | 0,52 | 0,0511 | 0,0028 | 0,73 | 0,0715 | 0,0041 | 0,73 | 0,0715 | 0,0065 | 1,06 | 0,0817 | 0,0052 | 1,07 | 0,0817 | 0,0081 |
| A10- | Hallein | Puch Urstein | 1,07 | 0,1054 | 0,0037 | 1,07 | 0,1054 | 0,0058 | 1,50 | 0,1476 | 0,0085 | 1,51 | 0,1476 | 0,0133 | 2,20 | 0,1687 | 0,0107 | 2,20 | 0,1687 | 0,0168 |
| A10- | Kuchl | Hallein | 1,19 | 0,1171 | 0,0041 | 1,19 | 0,1171 | 0,0064 | 1,67 | 0,1639 | 0,0094 | 1,67 | 0,1639 | 0,0148 | 2,44 | 0,1873 | 0,0119 | 2,45 | 0,1873 | 0,0187 |
| A10- | Golling / Abtenau | Kuchl | 1,19 | 0,1177 | 0,0041 | 1,20 | 0,1177 | 0,0065 | 1,68 | 0,1648 | 0,0095 | 1,68 | 0,1648 | 0,0149 | 2,45 | 0,1883 | 0,0119 | 2,46 | 0,1883 | 0,0188 |
| A10- | Paß Lueg | Golling / Abtenau | 1,25 | 0,1228 | 0,0043 | 1,25 | 0,1228 | 0,0068 | 1,75 | 0,1719 | 0,0099 | 1,75 | 0,1719 | 0,0155 | 2,56 | 0,1965 | 0,0125 | 2,57 | 0,1965 | 0,0196 |
| A10- | Werfen | Paß Lueg | 1,77 | 0,1749 | 0,0061 | 1,78 | 0,1749 | 0,0096 | 2,49 | 0,2449 | 0,0141 | 2,50 | 0,2449 | 0,0221 | 3,64 | 0,2799 | 0,0178 | 3,65 | 0,2799 | 0,0279 |
| A10- | Pfarrwerfen / Werfen | Werfen | 0,23 | 0,0228 | 0,0008 | 0,23 | 0,0228 | 0,0013 | 0,32 | 0,0319 | 0,0018 | 0,33 | 0,0319 | 0,0029 | 0,48 | 0,0365 | 0,0023 | 0,48 | 0,0365 | 0,0036 |
| A10- | KN Pongau | Pfarrwerfen / Werfen | 0,50 | 0,0495 | 0,0017 | 0,50 | 0,0495 | 0,0027 | 0,70 | 0,0693 | 0,0040 | 0,71 | 0,0693 | 0,0063 | 1,03 | 0,0792 | 0,0050 | 1,03 | 0,0792 | 0,0079 |
| A101 | Bischofshofen Mühlbach a. Hochkönig | KN Pongau | 0,75 | 0,0736 | 0,0026 | 0,75 | 0,0736 | 0,0040 | 1,05 | 0,1030 | 0,0059 | 1,05 | 0,1030 | 0,0093 | 1,53 | 0,1178 | 0,0075 | 1,54 | 0,1178 | 0,0117 |
| A10- | Lammertal Hüttal | KN Pongau | 2,04 | 0,2013 | 0,0070 | 2,05 | 0,2013 | 0,0111 | 2,86 | 0,2818 | 0,0162 | 2,87 | 0,2818 | 0,0255 | 4,19 | 0,3220 | 0,0204 | 4,20 | 0,3220 | 0,0321 |
| A10- | F. Verbindung GH Eben | Lammertal Hüttal | 0,53 | 0,0518 | 0,0018 | 0,53 | 0,0518 | 0,0028 | 0,74 | 0,0725 | 0,0042 | 0,74 | 0,0725 | 0,0066 | 1,08 | 0,0829 | 0,0053 | 1,08 | 0,0829 | 0,00 |

| | | | | | | | | | | | | | | | | | | | | |
|------|-------------------------------------|-------------------------------------|------|--------|--------|------|--------|--------|------|--------|--------|------|--------|--------|-------|--------|--------|-------|--------|--------|
| A12- | Kufstein Nord | Staatsgrenze Kufstein | 0,36 | 0,0000 | 0,0000 | 0,36 | 0,0000 | 0,0000 | 0,51 | 0,0000 | 0,0000 | 0,51 | 0,0000 | 0,0000 | 0,76 | 0,0000 | 0,0000 | 0,76 | 0,0000 | 0,0000 |
| A12- | Kufstein Süd | Kufstein Nord | 0,93 | 0,0000 | 0,0000 | 0,93 | 0,0000 | 0,0000 | 1,31 | 0,0000 | 0,0000 | 1,31 | 0,0000 | 0,0000 | 1,96 | 0,0000 | 0,0000 | 1,96 | 0,0000 | 0,0000 |
| A12- | Kirchbichl Langkampfen | Kufstein Süd | 1,27 | 0,0000 | 0,0000 | 1,27 | 0,0000 | 0,0000 | 1,78 | 0,0000 | 0,0000 | 1,78 | 0,0000 | 0,0000 | 2,68 | 0,0000 | 0,0000 | 2,68 | 0,0000 | 0,0000 |
| A12- | Wörgl Ost St.Johann i. T. Brixental | Kirchbichl Langkampfen | 1,25 | 0,0000 | 0,0000 | 1,25 | 0,0000 | 0,0000 | 1,75 | 0,0000 | 0,0000 | 1,75 | 0,0000 | 0,0000 | 2,62 | 0,0000 | 0,0000 | 2,62 | 0,0000 | 0,0000 |
| A12- | Wörgl West | Wörgl Ost St.Johann i. T. Brixental | 0,66 | 0,0000 | 0,0000 | 0,66 | 0,0000 | 0,0000 | 0,92 | 0,0000 | 0,0000 | 0,92 | 0,0000 | 0,0000 | 1,38 | 0,0000 | 0,0000 | 1,38 | 0,0000 | 0,0000 |
| A12- | Kramsach Rattenberg Brixlegg | Wörgl West | 2,80 | 0,0000 | 0,0000 | 2,80 | 0,0000 | 0,0000 | 3,92 | 0,0000 | 0,0000 | 3,92 | 0,0000 | 0,0000 | 5,88 | 0,0000 | 0,0000 | 5,88 | 0,0000 | 0,0000 |
| A12- | Wiesing Achensee Zillertal | Kramsach Rattenberg Brixlegg | 1,72 | 0,0000 | 0,0000 | 1,72 | 0,0000 | 0,0000 | 2,40 | 0,0000 | 0,0000 | 2,40 | 0,0000 | 0,0000 | 3,61 | 0,0000 | 0,0000 | 3,61 | 0,0000 | 0,0000 |
| A12- | Jenbach | Wiesing Achensee Zillertal | 0,68 | 0,0000 | 0,0000 | 0,68 | 0,0000 | 0,0000 | 0,95 | 0,0000 | 0,0000 | 0,95 | 0,0000 | 0,0000 | 1,43 | 0,0000 | 0,0000 | 1,43 | 0,0000 | 0,0000 |
| A12- | Schwaz | Jenbach | 1,50 | 0,0000 | 0,0000 | 1,50 | 0,0000 | 0,0000 | 2,10 | 0,0000 | 0,0000 | 2,10 | 0,0000 | 0,0000 | 3,15 | 0,0000 | 0,0000 | 3,15 | 0,0000 | 0,0000 |
| A12- | Vomp | Schwaz | 0,86 | 0,0000 | 0,0000 | 0,86 | 0,0000 | 0,0000 | 1,20 | 0,0000 | 0,0000 | 1,20 | 0,0000 | 0,0000 | 1,80 | 0,0000 | 0,0000 | 1,80 | 0,0000 | 0,0000 |
| A12- | Wattens | Vomp | 1,77 | 0,0000 | 0,0000 | 1,77 | 0,0000 | 0,0000 | 2,47 | 0,0000 | 0,0000 | 2,47 | 0,0000 | 0,0000 | 3,71 | 0,0000 | 0,0000 | 3,71 | 0,0000 | 0,0000 |
| A12- | Hall/Tirol Mitte | Wattens | 1,57 | 0,0000 | 0,0000 | 1,57 | 0,0000 | 0,0000 | 2,19 | 0,0000 | 0,0000 | 2,19 | 0,0000 | 0,0000 | 3,29 | 0,0000 | 0,0000 | 3,29 | 0,0000 | 0,0000 |
| A12- | Hall/Tirol West | Hall/Tirol Mitte | 0,63 | 0,0000 | 0,0000 | 0,63 | 0,0000 | 0,0000 | 0,88 | 0,0000 | 0,0000 | 0,88 | 0,0000 | 0,0000 | 1,32 | 0,0000 | 0,0000 | 1,32 | 0,0000 | 0,0000 |
| A12- | A12 Innsbruck Ost | Hall/Tirol West | 0,70 | 0,0000 | 0,0000 | 0,70 | 0,0000 | 0,0000 | 0,97 | 0,0000 | 0,0000 | 0,97 | 0,0000 | 0,0000 | 1,46 | 0,0000 | 0,0000 | 1,46 | 0,0000 | 0,0000 |
| A12- | Innsbruck Mitte | A12 Innsbruck Ost | 0,46 | 0,0113 | 0,0004 | 0,47 | 0,0113 | 0,0006 | 0,65 | 0,0158 | 0,0009 | 0,65 | 0,0158 | 0,0014 | 0,98 | 0,0181 | 0,0011 | 0,98 | 0,0181 | 0,0011 |
| A12- | A12 Innsbruck West | Innsbruck Mitte | 0,65 | 0,0640 | 0,0022 | 0,65 | 0,0640 | 0,0035 | 0,91 | 0,0896 | 0,0052 | 0,91 | 0,0896 | 0,0081 | 1,33 | 0,1024 | 0,0065 | 1,34 | 0,1024 | 0,0102 |
| A12- | Innsbruck Kranebitten | A12 Innsbruck West | 0,85 | 0,0839 | 0,0029 | 0,85 | 0,0839 | 0,0046 | 1,19 | 0,1174 | 0,0068 | 1,20 | 0,1174 | 0,0106 | 1,75 | 0,1342 | 0,0085 | 1,75 | 0,1342 | 0,0134 |
| A12- | Zirl Ost Garmisch Seefeld | Innsbruck Kranebitten | 0,99 | 0,0973 | 0,0034 | 0,99 | 0,0973 | 0,0054 | 1,39 | 0,1363 | 0,0078 | 1,39 | 0,1363 | 0,0123 | 2,03 | 0,1557 | 0,0099 | 2,03 | 0,1557 | 0,0155 |
| A12- | Zirl West | Zirl Ost Garmisch Seefeld | 0,62 | 0,0609 | 0,0021 | 0,62 | 0,0609 | 0,0033 | 0,87 | 0,0853 | 0,0049 | 0,87 | 0,0853 | 0,0077 | 1,27 | 0,0974 | 0,0062 | 1,27 | 0,0974 | 0,0097 |
| A12- | Petttau | Zirl West | 1,11 | 0,1091 | 0,0038 | 1,11 | 0,1091 | 0,0060 | 1,55 | 0,1527 | 0,0088 | 1,56 | 0,1527 | 0,0138 | 2,27 | 0,1745 | 0,0111 | 2,28 | 0,1745 | 0,0174 |
| A12- | Telfs Ost | Petttau | 1,12 | 0,1103 | 0,0039 | 1,12 | 0,1103 | 0,0061 | 1,57 | 0,1544 | 0,0089 | 1,57 | 0,1544 | 0,0139 | 2,30 | 0,1764 | 0,0112 | 2,30 | 0,1764 | 0,0176 |
| A12- | Telfs West | Telfs Ost | 0,55 | 0,0538 | 0,0019 | 0,55 | 0,0538 | 0,0030 | 0,77 | 0,0754 | 0,0043 | 0,77 | 0,0754 | 0,0068 | 1,12 | 0,0861 | 0,0055 | 1,12 | 0,0861 | 0,0086 |
| A12- | Mötz Reutte | Telfs West | 1,77 | 0,1740 | 0,0061 | 1,77 | 0,1740 | 0,0096 | 2,48 | 0,2436 | 0,0140 | 2,48 | 0,2436 | 0,0220 | 3,62 | 0,2784 | 0,0177 | 3,64 | 0,2784 | 0,0278 |
| A12- | Haiming Ötztal | Mötz Reutte | 2,05 | 0,2024 | 0,0071 | 2,06 | 0,2024 | 0,0111 | 2,88 | 0,2834 | 0,0163 | 2,89 | 0,2834 | 0,0256 | 4,22 | 0,3238 | 0,0205 | 4,23 | 0,3238 | 0,0323 |
| A12- | Imst | Haiming Ötztal | 1,63 | 0,1611 | 0,0056 | 1,64 | 0,1611 | 0,0089 | 2,29 | 0,2256 | 0,0130 | 2,30 | 0,2256 | 0,0204 | 3,36 | 0,2578 | 0,0164 | 3,37 | 0,2578 | 0,0257 |
| A12- | Imst Au | Imst | 0,48 | 0,0475 | 0,0017 | 0,48 | 0,0475 | 0,0026 | 0,68 | 0,0665 | 0,0038 | 0,68 | 0,0665 | 0,0060 | 0,99 | 0,0760 | 0,0048 | 0,99 | 0,0760 | 0,0076 |
| A12- | Mils | Imst Au | 0,39 | 0,0384 | 0,0013 | 0,39 | 0,0384 | 0,0021 | 0,55 | 0,0537 | 0,0031 | 0,55 | 0,0537 | 0,0049 | 0,80 | 0,0614 | 0,0039 | 0,80 | 0,0614 | 0,0061 |
| A12- | Mils Schönwies | Mils | 0,96 | 0,0944 | 0,0033 | 0,96 | 0,0944 | 0,0052 | 1,34 | 0,1322 | 0,0076 | 1,35 | 0,1322 | 0,0119 | 1,97 | 0,1510 | 0,0096 | 1,97 | 0,1510 | 0,0151 |
| A12- | KN Oberinntal | Mils Schönwies | 0,85 | 0,0836 | 0,0029 | 0,85 | 0,0836 | 0,0046 | 1,19 | 0,1170 | 0,0067 | 1,19 | 0,1170 | 0,0106 | 1,74 | 0,1338 | 0,0085 | 1,75 | 0,1338 | 0,0133 |
| A12- | Zams | KN Oberinntal | 0,22 | 0,0220 | 0,0008 | 0,22 | 0,0220 | 0,0012 | 0,31 | 0,0308 | 0,0018 | 0,31 | 0,0308 | 0,0028 | 0,46 | 0,0352 | 0,0022 | 0,46 | 0,0352 | 0,0035 |
| A122 | Fließ | KN Oberinntal | 1,59 | 0,1564 | 0,0055 | 1,59 | 0,1564 | 0,0086 | 2,23 | 0,2190 | 0,0126 | 2,23 | 0,2190 | 0,0198 | 3,26 | 0,2502 | 0,0159 | 3,27 | 0,2502 | 0,0249 |
| A13- | A13 Innsbruck Süd | A12 Innsbruck Ost | 2,20 | 0,0000 | 0,0000 | 2,20 | 0,0000 | 0,0000 | 3,08 | 0,0000 | 0,0000 | 3,08 | 0,0000 | 0,0000 | 4,62 | 0,0000 | 0,0000 | 8,50 | 0,0000 | 0,0000 |
| A13- | Zenzenhof | A13 Innsbruck Süd | 0,88 | 0,0000 | 0,0000 | 0,88 | 0,0000 | 0,0000 | 1,23 | 0,0000 | 0,0000 | 1,23 | 0,0000 | 0,0000 | 1,84 | 0,0000 | 0,0000 | 3,68 | 0,0000 | 0,0000 |
| A13- | Igls Patsch | Zenzenhof | 1,62 | 0,0000 | 0,0000 | 1,62 | 0,0000 | 0,0000 | 2,27 | 0,0000 | 0,0000 | 2,27 | 0,0000 | 0,0000 | 3,41 | 0,0000 | 0,0000 | 6,82 | 0,0000 | 0,0000 |
| A13- | Schönberg Stubaital | Igls Patsch | 1,76 | 0,0000 | 0,0000 | 1,76 | 0,0000 | 0,0000 | 2,46 | 0,0000 | 0,0000 | 2,46 | 0,0000 | 0,0000 | 3,69 | 0,0000 | 0,0000 | 7,38 | 0,0000 | 0,0000 |
| A13- | Matrei Steinach | Schönberg Stubaital | 5,54 | 0,0000 | 0,0000 | 5,54 | 0,0000 | 0,0000 | 7,76 | 0,0000 | 0,0000 | 7,76 | 0,0000 | 0,0000 | 11,63 | 0,0000 | 0,0000 | 23,26 | 0,0000 | 0,0000 |
| A13- | Nösslach | Matrei Steinach | 4,46 | 0,0000 | 0,0000 | 4,46 | 0,0000 | 0,0000 | 6,24 | 0,0000 | 0,0000 | 6,24 | 0,0000 | 0,0000 | 9,36 | 0,0000 | 0,0000 | 18,72 | 0,0000 | 0,0000 |
| A13- | Brenner-Nord | Nösslach | 4,00 | 0,0000 | 0,0000 | 4,00 | 0,0000 | 0,0000 | 5,60 | 0,0000 | 0,0000 | 5,60 | 0,0000 | 0,0000 | 8,40 | 0,0000 | 0,0000 | 16,80 | 0,0000 | 0,0000 |
| A13- | Staatsgrenze Brennerpass | Brenner-Nord | 0,79 | 0,0000 | 0,0000 | 0,79 | 0,0000 | 0,0000 | 1,11 | 0,0000 | 0,0000 | 1,11 | 0,0000 | 0,0000 | 1,66 | 0,0000 | 0,0000 | 3,32 | 0,0000 | 0,0000 |
| A131 | A13 Innsbruck Süd | A12 Innsbruck West | 1,41 | 0,0208 | 0,0007 | 1,41 | 0,0208 | 0,0011 | 1,98 | 0,0291 | 0,0017 | 1,98 | 0,0291 | 0,0026 | 2,95 | 0,0333 | 0,0021 | 5,47 | 0,0333 | 0,0033 |
| A14- | Hörbranz Lochau | Staatsgrenze Hörbranz | 0,26 | 0,0252 | 0,0009 | 0,26 | 0,0252 | 0,0014 | 0,36 | 0,0353 | 0,0020 | 0,36 | 0,0353 | 0,0032 | 0,53 | 0,0404 | 0,0026 | 0,53 | 0,0404 | 0,0040 |
| A14- | KN Bregenz | Hörbranz Lochau | 1,57 | 0,1550 | 0,0054 | 1,58 | 0,1550 | 0,0085 | 2,21 | 0,2170 | 0,0125 | 2,21 | 0,2170 | 0,0196 | 3,23 | 0,2480 | 0,0157 | 3,24 | 0,2480 | 0,0247 |
| A14- | Lauterach Wolfurt | KN Bregenz | 0,08 | 0,0078 | 0,0003 | 0,08 | 0,0078 | 0,0004 | 0,11 | 0,0109 | 0,0006 | 0,11 | 0,0109 | 0,0010 | 0,16 | 0,0124 | 0,0008 | 0,16 | 0,0124 | 0,0012 |
| A14- | Wolfurt Lauterach | Lauterach Wolfurt | 0,70 | 0,0690 | 0,0024 | 0,70 | 0,0690 | 0,0038 | 0,98 | 0,0965 | 0,0056 | 0,98 | 0,0965 | 0,0087 | 1,44 | 0,1103 | 0,0070 | 1,44 | 0,1103 | 0,0110 |
| A14- | Dornbirn Nord Bregenzerwald | Wolfurt Lauterach | 0,27 | 0,0267 | 0,0009 | 0,27 | 0,0267 | 0,0015 | 0,38 | 0,0374 | 0,0021 | 0,38 | 0,0374 | 0,0034 | 0,56 | 0,0427 | 0,0027 | 0,56 | 0,0427 | 0,0043 |
| A14- | Dornbirn Süd Lustenau | Dornbirn Nord Bregenzerwald | 0,76 | 0,0745 | 0,0026 | 0,76 | 0,0745 | 0,0041 | 1,06 | 0,1044 | 0,0060 | 1,06 | 0,1044 | 0,0094 | 1,55 | 0,1193 | 0,0076 | 1,56 | 0,1193 | 0,0119 |
| A14- | Hohenems | Dornbirn Süd Lustenau | 1,06 | 0,1049 | 0,0037 | 1,07 | 0,1049 | 0,0058 | 1,49 | 0,1468 | 0,0084 | 1,50 | 0,1468 | 0,0133 | 2,18 | 0,1678 | 0,0106 | 2,19 | 0,1678 | 0,0167 |
| A14- | Altach Götzis | Hohenems | 0,69 | 0,0684 | 0,0024 | 0,70 | 0,0684 | 0,0038 | 0,97 | 0,0957 | 0,0055 | 0,98 | 0,0957 | 0,0087 | 1,42 | 0,1094 | 0,0069 | 1,43 | 0,1094 | 0,0109 |
| A14- | Götzis | Altach Götzis | 0,53 | 0,0521 | 0,0018 | 0,53 | 0,0521 | 0,0029 | 0,74 | 0,0730 | 0,0042 | 0,74 | 0,0730 | 0,0066 | 1,09 | 0,0834 | 0,0053 | 1,09 | 0,0834 | 0,0083 |
| A14- | Klaus Koblach | Götzis | 0,46 | 0,0453 | 0,0016 | 0,46 | 0,0453 | 0,0025 | 0,64 | 0,0634 | 0,0036 | 0,65 | 0,0634 | 0,0057 | 0,94 | 0,0724 | 0,0046 | 0,95 | 0,0724 | 0,0072 |
| A14- | Rankweil | Klaus Koblach | 0,81 | 0,0796 | 0,0028 | 0,81 | 0,0796 | 0,0044 | 1,13 | 0,1114 | 0,0064 | 1,14 | 0,1114 | 0,0101 | 1,66 | 0,1273 | 0,0081 | 1,66 | 0,1273 | 0,0127 |
| A14- | Feldkirch Frastanz | Rankweil | 1,15 | 0,1134 | 0,0040 | 1,15 | 0,1134 | 0,0062 | 1,61 | 0,1587 | 0,0091 | 1,62 | 0,1587 | 0,0143 | 2,36 | 0,1814 | 0,0115 | 2,37 | 0,1814 | 0,0181 |
| A14- | Nenzing Bludesch | Feldkirch Frastanz | 1,82 | 0,1793 | 0,0063 | 1,82 | 0,1793 | 0,0099 | 2,55 | 0,2510 | 0,0144 | 2,56 | 0,2510 | 0,0227 | 3,73 | 0,2868 | 0,0182 | 3,74 | 0,2868 | 0,0286 |
| A14- | Bludenz Nüziders | Nenzing Bludesch | 1,35 | 0,1331 | 0,0047 | 1,35 | 0,1331 | 0,0073 | 1,89 | 0,1863 | 0,0107 | 1,90 | 0,1863 | 0,0168 | 2,79 | 0,2129 | 0,0135 | 2,78 | 0,2129 | 0,0212 |
| A14- | Brandnertal | Bludenz Nüziders | 0,19 | 0,0185 | 0,0006 | 0,19 | 0,0185 | 0,0010 | 0,26 | 0,0259 | 0,0015 | 0,26 | 0,0259 | 0,0023 | 0,39 | 0,0296 | 0,0019 | 0,39 | 0,0296 | 0,0030 |
| A14- | Bludenz Bürs | Brandnertal | 0,31 | 0,0309 | 0,0011 | 0,31 | 0,0309 | 0,0017 | 0,44 | 0,0433 | 0,0025 | 0,44 | 0,0433 | 0,0039 | 0,64 | 0,0494 | 0,0031 | 0,65 | 0,0494 | 0,0049 |
| A14- | Bludenz Montafon | Bludenz Bürs | 0,44 | 0,043 | | | | | | | | | | | | | | | | |

| | | | | | | | | | | | | | | | | | | | | |
|------|--------------------------------------|--------------------------------------|------|--------|--------|------|--------|--------|------|--------|--------|------|--------|--------|------|--------|--------|------|--------|--------|
| A22- | Strebersdorf | KN Gürtel Nordbrücke | 0,61 | 0,0602 | 0,0021 | 0,61 | 0,0602 | 0,0033 | 0,86 | 0,0842 | 0,0048 | 0,86 | 0,0842 | 0,0076 | 1,25 | 0,0963 | 0,0061 | 1,26 | 0,0963 | 0,0096 |
| A221 | KN Gürtel Nordbrücke | Wien Nordbrücke | 0,18 | 0,0177 | 0,0006 | 0,18 | 0,0177 | 0,0010 | 0,25 | 0,0248 | 0,0014 | 0,25 | 0,0248 | 0,0022 | 0,37 | 0,0284 | 0,0018 | 0,37 | 0,0284 | 0,0028 |
| A221 | Wien Pragerstraße | KN Gürtel Nordbrücke | 0,19 | 0,0191 | 0,0007 | 0,19 | 0,0191 | 0,0011 | 0,27 | 0,0267 | 0,0015 | 0,27 | 0,0267 | 0,0024 | 0,40 | 0,0306 | 0,0019 | 0,40 | 0,0306 | 0,0030 |
| A221 | Wien Neujedlersdorf | Wien Pragerstraße | 0,08 | 0,0084 | 0,0003 | 0,09 | 0,0084 | 0,0005 | 0,12 | 0,0117 | 0,0007 | 0,12 | 0,0117 | 0,0011 | 0,17 | 0,0134 | 0,0008 | 0,17 | 0,0134 | 0,0013 |
| A221 | Brünnerstr/Shuttlewort hstraße | Wien Neujedlersdorf | 0,22 | 0,0212 | 0,0007 | 0,22 | 0,0212 | 0,0012 | 0,30 | 0,0297 | 0,0017 | 0,30 | 0,0297 | 0,0027 | 0,44 | 0,0339 | 0,0022 | 0,44 | 0,0339 | 0,0034 |
| A22- | Korneuburg Ost | Strebersdorf | 1,23 | 0,1212 | 0,0042 | 1,23 | 0,1212 | 0,0067 | 1,73 | 0,1697 | 0,0098 | 1,73 | 0,1697 | 0,0153 | 2,52 | 0,1939 | 0,0123 | 2,53 | 0,1939 | 0,0193 |
| A222 | Wien Vohburggasse | Strebersdorf | 0,15 | 0,0151 | 0,0005 | 0,15 | 0,0151 | 0,0008 | 0,21 | 0,0211 | 0,0012 | 0,22 | 0,0211 | 0,0019 | 0,31 | 0,0241 | 0,0015 | 0,31 | 0,0241 | 0,0024 |
| A22- | KN Korneuburg | Korneuburg Ost | 0,79 | 0,0782 | 0,0027 | 0,80 | 0,0782 | 0,0043 | 1,11 | 0,1095 | 0,0063 | 1,12 | 0,1095 | 0,0099 | 1,63 | 0,1252 | 0,0079 | 1,63 | 0,1252 | 0,0125 |
| A22- | Stockerau Ost | KN Korneuburg | 1,15 | 0,1138 | 0,0040 | 1,16 | 0,1138 | 0,0063 | 1,62 | 0,1593 | 0,0092 | 1,63 | 0,1593 | 0,0144 | 2,37 | 0,1821 | 0,0116 | 2,38 | 0,1821 | 0,0182 |
| A22- | Stockerau Mitte | Stockerau Ost | 0,46 | 0,0454 | 0,0016 | 0,46 | 0,0454 | 0,0025 | 0,65 | 0,0635 | 0,0037 | 0,65 | 0,0635 | 0,0057 | 0,95 | 0,0726 | 0,0046 | 0,95 | 0,0726 | 0,0072 |
| A22- | KN Stockerau/West | Stockerau Mitte | 0,39 | 0,0385 | 0,0013 | 0,39 | 0,0385 | 0,0021 | 0,55 | 0,0540 | 0,0031 | 0,55 | 0,0540 | 0,0049 | 0,80 | 0,0617 | 0,0039 | 0,81 | 0,0617 | 0,0061 |
| A23- | KN Wien Inzersdorf | Altmannsdorferstraße | 0,34 | 0,0337 | 0,0012 | 0,34 | 0,0337 | 0,0019 | 0,48 | 0,0472 | 0,0027 | 0,48 | 0,0472 | 0,0043 | 0,70 | 0,0540 | 0,0034 | 0,70 | 0,0540 | 0,0054 |
| A23- | Favoriten | KN Wien Inzersdorf | 0,86 | 0,0850 | 0,0030 | 0,86 | 0,0850 | 0,0047 | 1,21 | 0,1191 | 0,0068 | 1,21 | 0,1191 | 0,0108 | 1,77 | 0,1361 | 0,0086 | 1,78 | 0,1361 | 0,0136 |
| A23- | KN Gürtel Landstraßer Hauptstraße | Favoriten | 0,54 | 0,0533 | 0,0019 | 0,54 | 0,0533 | 0,0029 | 0,76 | 0,0746 | 0,0043 | 0,76 | 0,0746 | 0,0067 | 1,11 | 0,0852 | 0,0054 | 1,11 | 0,0852 | 0,0085 |
| A23- | St. Marx | KN Gürtel Landstraßer Hauptstraße | 0,21 | 0,0202 | 0,0007 | 0,21 | 0,0202 | 0,0011 | 0,29 | 0,0283 | 0,0016 | 0,29 | 0,0283 | 0,0026 | 0,42 | 0,0324 | 0,0021 | 0,42 | 0,0324 | 0,0032 |
| A23- | KN Wien Prater | St. Marx | 0,17 | 0,0172 | 0,0006 | 0,17 | 0,0172 | 0,0009 | 0,24 | 0,0240 | 0,0014 | 0,25 | 0,0240 | 0,0022 | 0,36 | 0,0275 | 0,0017 | 0,36 | 0,0275 | 0,0027 |
| A23- | Handelskai | KN Wien Prater | 0,39 | 0,0381 | 0,0013 | 0,39 | 0,0381 | 0,0021 | 0,54 | 0,0533 | 0,0031 | 0,54 | 0,0533 | 0,0048 | 0,79 | 0,0610 | 0,0039 | 0,80 | 0,0610 | 0,0061 |
| A23- | KN Wien Kaisermühlen | Handelskai | 0,18 | 0,0174 | 0,0006 | 0,18 | 0,0174 | 0,0010 | 0,25 | 0,0244 | 0,0014 | 0,25 | 0,0244 | 0,0022 | 0,36 | 0,0279 | 0,0018 | 0,36 | 0,0279 | 0,0028 |
| A23- | Groß Enzersdorf Stadlau | KN Wien Kaisermühlen | 0,49 | 0,0478 | 0,0017 | 0,49 | 0,0478 | 0,0026 | 0,68 | 0,0669 | 0,0038 | 0,68 | 0,0669 | 0,0060 | 1,00 | 0,0765 | 0,0049 | 1,00 | 0,0765 | 0,0076 |
| A23- | Hirschstetten | Groß Enzersdorf Stadlau | 0,27 | 0,0268 | 0,0009 | 0,27 | 0,0268 | 0,0015 | 0,38 | 0,0375 | 0,0022 | 0,38 | 0,0375 | 0,0034 | 0,56 | 0,0429 | 0,0027 | 0,56 | 0,0429 | 0,0043 |
| A233 | Wien Gürtel | KN Gürtel Landstraßer Hauptstraße | 0,16 | 0,0156 | 0,0005 | 0,16 | 0,0156 | 0,0009 | 0,22 | 0,0219 | 0,0013 | 0,22 | 0,0219 | 0,0020 | 0,33 | 0,0250 | 0,0016 | 0,33 | 0,0250 | 0,0025 |
| A25- | Weißkirchen | KN A1/A25 Passau Wels | 1,79 | 0,1763 | 0,0062 | 1,79 | 0,1763 | 0,0097 | 2,51 | 0,2468 | 0,0142 | 2,52 | 0,2468 | 0,0223 | 3,67 | 0,2821 | 0,0179 | 3,68 | 0,2821 | 0,0281 |
| A25- | Marchtrenk Wels Ost | Weißkirchen | 0,64 | 0,0628 | 0,0022 | 0,64 | 0,0628 | 0,0035 | 0,89 | 0,0879 | 0,0051 | 0,90 | 0,0879 | 0,0079 | 1,31 | 0,1005 | 0,0064 | 1,31 | 0,1005 | 0,0100 |
| A25- | ÖBB Terminal Wels | Marchtrenk Wels Ost | 0,17 | 0,0169 | 0,0006 | 0,17 | 0,0169 | 0,0009 | 0,24 | 0,0237 | 0,0014 | 0,24 | 0,0237 | 0,0021 | 0,35 | 0,0270 | 0,0017 | 0,35 | 0,0270 | 0,0027 |
| A25- | Wels Nord | ÖBB Terminal Wels | 0,82 | 0,0810 | 0,0028 | 0,82 | 0,0810 | 0,0045 | 1,15 | 0,1134 | 0,0065 | 1,16 | 0,1134 | 0,0102 | 1,69 | 0,1296 | 0,0082 | 1,69 | 0,1296 | 0,0129 |
| A25- | KN Wels | Wels Nord | 0,58 | 0,0576 | 0,0020 | 0,59 | 0,0576 | 0,0032 | 0,82 | 0,0807 | 0,0046 | 0,82 | 0,0807 | 0,0073 | 1,20 | 0,0922 | 0,0059 | 1,20 | 0,0922 | 0,0092 |
| S01- | Vorarlberger Allee | KN Vösendorf | 0,43 | 0,0427 | 0,0015 | 0,43 | 0,0427 | 0,0024 | 0,61 | 0,0598 | 0,0034 | 0,61 | 0,0598 | 0,0054 | 0,89 | 0,0684 | 0,0043 | 0,89 | 0,0684 | 0,0068 |
| S01- | Laxenburger Str. | Vorarlberger Allee | 0,23 | 0,0224 | 0,0008 | 0,23 | 0,0224 | 0,0012 | 0,32 | 0,0314 | 0,0018 | 0,32 | 0,0314 | 0,0028 | 0,47 | 0,0359 | 0,0023 | 0,47 | 0,0359 | 0,0036 |
| S01- | Güterzentrum Wien Süd | Laxenburger Str. | 0,28 | 0,0278 | 0,0010 | 0,28 | 0,0278 | 0,0015 | 0,40 | 0,0389 | 0,0022 | 0,40 | 0,0389 | 0,0035 | 0,58 | 0,0445 | 0,0028 | 0,58 | 0,0445 | 0,0044 |
| S01- | Rothneusiedl | Güterzentrum Wien Süd | 0,18 | 0,0181 | 0,0006 | 0,18 | 0,0181 | 0,0010 | 0,26 | 0,0253 | 0,0015 | 0,26 | 0,0253 | 0,0023 | 0,38 | 0,0289 | 0,0018 | 0,38 | 0,0289 | 0,0029 |
| S01- | KN Rustenfeld | Rothneusiedl | 0,43 | 0,0423 | 0,0015 | 0,43 | 0,0423 | 0,0023 | 0,60 | 0,0592 | 0,0034 | 0,60 | 0,0592 | 0,0054 | 0,88 | 0,0677 | 0,0043 | 0,88 | 0,0677 | 0,0067 |
| S01- | Rannersdorf | KN Rustenfeld | 0,60 | 0,0594 | 0,0021 | 0,60 | 0,0594 | 0,0033 | 0,85 | 0,0831 | 0,0048 | 0,85 | 0,0831 | 0,0075 | 1,24 | 0,0950 | 0,0060 | 1,24 | 0,0950 | 0,0095 |
| S011 | Leopoldsdorf (B16) | KN Rustenfeld | 0,27 | 0,0263 | 0,0009 | 0,27 | 0,0263 | 0,0014 | 0,37 | 0,0368 | 0,0021 | 0,38 | 0,0368 | 0,0033 | 0,55 | 0,0421 | 0,0027 | 0,55 | 0,0421 | 0,0042 |
| S01- | Schwechat Süd | Rannersdorf | 0,47 | 0,0464 | 0,0016 | 0,47 | 0,0464 | 0,0026 | 0,66 | 0,0649 | 0,0037 | 0,66 | 0,0649 | 0,0059 | 0,97 | 0,0742 | 0,0047 | 0,97 | 0,0742 | 0,0074 |
| S01- | Schwechat Ost | Schwechat Süd | 0,27 | 0,0266 | 0,0009 | 0,27 | 0,0266 | 0,0015 | 0,38 | 0,0372 | 0,0021 | 0,38 | 0,0372 | 0,0034 | 0,55 | 0,0425 | 0,0027 | 0,55 | 0,0425 | 0,0042 |
| S01- | Mannswörth | Schwechat Ost | 0,29 | 0,0281 | 0,0010 | 0,29 | 0,0281 | 0,0015 | 0,40 | 0,0394 | 0,0023 | 0,40 | 0,0394 | 0,0036 | 0,59 | 0,0450 | 0,0029 | 0,59 | 0,0450 | 0,0045 |
| S01- | KN Schwechat | Mannswörth | 0,11 | 0,0105 | 0,0004 | 0,11 | 0,0105 | 0,0006 | 0,15 | 0,0148 | 0,0008 | 0,15 | 0,0148 | 0,0013 | 0,22 | 0,0169 | 0,0011 | 0,22 | 0,0169 | 0,0017 |
| S01- | Seyring | Angerner Straße | 1,00 | 0,0985 | 0,0034 | 1,00 | 0,0985 | 0,0054 | 1,40 | 0,1380 | 0,0079 | 1,41 | 0,1380 | 0,0125 | 2,05 | 0,1577 | 0,0100 | 2,06 | 0,1577 | 0,0157 |
| S01- | KN Eibesbrunn | Seyring | 0,84 | 0,0824 | 0,0029 | 0,84 | 0,0824 | 0,0045 | 1,17 | 0,1154 | 0,0066 | 1,18 | 0,1154 | 0,0104 | 1,72 | 0,1319 | 0,0084 | 1,72 | 0,1319 | 0,0131 |
| S01- | Hagenbrunn | KN Eibesbrunn | 0,66 | 0,0649 | 0,0023 | 0,66 | 0,0649 | 0,0036 | 0,92 | 0,0909 | 0,0052 | 0,93 | 0,0909 | 0,0082 | 1,35 | 0,1038 | 0,0066 | 1,36 | 0,1038 | 0,0104 |
| S01- | Korneuburg Nord | Hagenbrunn | 1,41 | 0,1388 | 0,0049 | 1,41 | 0,1388 | 0,0076 | 1,98 | 0,1944 | 0,0112 | 1,98 | 0,1944 | 0,0176 | 2,89 | 0,2221 | 0,0141 | 2,90 | 0,2221 | 0,0221 |
| S01- | Korneuburg West | Korneuburg Nord | 0,57 | 0,0563 | 0,0020 | 0,57 | 0,0563 | 0,0031 | 0,80 | 0,0788 | 0,0045 | 0,80 | 0,0788 | 0,0071 | 1,17 | 0,0901 | 0,0057 | 1,18 | 0,0901 | 0,0090 |
| S01- | KN Korneuburg | Korneuburg West | 0,18 | 0,0180 | 0,0006 | 0,18 | 0,0180 | 0,0010 | 0,26 | 0,0251 | 0,0014 | 0,26 | 0,0251 | 0,0023 | 0,37 | 0,0287 | 0,0018 | 0,38 | 0,0287 | 0,0029 |
| S02- | Gewerbepark Stadlau | Hirschstetten | 0,20 | 0,0193 | 0,0007 | 0,20 | 0,0193 | 0,0011 | 0,27 | 0,0270 | 0,0016 | 0,28 | 0,0270 | 0,0024 | 0,40 | 0,0309 | 0,0020 | 0,40 | 0,0309 | 0,0031 |
| S02- | Breitenleer Straße | Gewerbepark Stadlau | 0,11 | 0,0107 | 0,0004 | 0,11 | 0,0107 | 0,0006 | 0,15 | 0,0150 | 0,0009 | 0,15 | 0,0150 | 0,0014 | 0,22 | 0,0171 | 0,0011 | 0,22 | 0,0171 | 0,0017 |
| S02- | Rautenweg | Breitenleer Straße | 0,18 | 0,0178 | 0,0006 | 0,18 | 0,0178 | 0,0010 | 0,25 | 0,0249 | 0,0014 | 0,25 | 0,0249 | 0,0022 | 0,37 | 0,0284 | 0,0018 | 0,37 | 0,0284 | 0,0028 |
| S02- | Hermann Gebauer Straße | Rautenweg | 0,20 | 0,0195 | 0,0007 | 0,20 | 0,0195 | 0,0011 | 0,28 | 0,0273 | 0,0016 | 0,28 | 0,0273 | 0,0025 | 0,41 | 0,0312 | 0,0020 | 0,41 | 0,0312 | 0,0031 |
| S02- | Angerner Straße | Hermann Gebauer Straße | 0,72 | 0,0706 | 0,0025 | 0,72 | 0,0706 | 0,0039 | 1,01 | 0,0989 | 0,0057 | 1,01 | 0,0989 | 0,0089 | 1,47 | 0,1130 | 0,0072 | 1,48 | 0,1130 | 0,0113 |
| S03- | Stockerau Nord | KN Stockerau/West | 0,20 | 0,0200 | 0,0007 | 0,20 | 0,0200 | 0,0011 | 0,28 | 0,0279 | 0,0016 | 0,29 | 0,0279 | 0,0025 | 0,42 | 0,0319 | 0,0020 | 0,42 | 0,0319 | 0,0032 |
| S03- | Sierndorf | Stockerau Nord | 1,09 | 0,1073 | 0,0038 | 1,09 | 0,1073 | 0,0059 | 1,53 | 0,1502 | 0,0086 | 1,53 | 0,1502 | 0,0136 | 2,23 | 0,1716 | 0,0109 | 2,24 | 0,1716 | 0,0171 |
| S03- | Obermallebarn | Sierndorf | 0,73 | 0,0720 | 0,0025 | 0,73 | 0,0720 | 0,0040 | 1,03 | 0,1009 | 0,0058 | 1,03 | 0,1009 | 0,0091 | 1,50 | 0,1153 | 0,0073 | 1,51 | 0,1153 | 0,0115 |
| S03- | Göllersdorf | Obermallebarn | 0,96 | 0,0951 | 0,0033 | 0,97 | 0,0951 | 0,0052 | 1,35 | 0,1332 | 0,0077 | 1,36 | 0,1332 | 0,0120 | 1,98 | 0,1522 | 0,0097 | 1,99 | 0,1522 | 0,0152 |
| S03- | Großstelzendorf | Göllersdorf | 0,39 | 0,0381 | 0,0013 | 0,39 | 0,0381 | 0,0021 | 0,54 | 0,0533 | 0,0031 | 0,54 | 0,0533 | 0,0048 | 0,79 | 0,0610 | 0,0039 | 0,80 | 0,0610 | 0,0061 |
| S03- | Hollabrunn Süd | Großstelzendorf | 0,93 | 0,0916 | 0,0032 | 0,93 | 0,0916 | 0,0050 | 1,30 | 0,1283 | 0,0074 | 1,31 | 0,1283 | 0,0116 | 1,91 | 0,1466 | 0,0093 | 1,91 | 0,1466 | 0,0146 |
| S04- | Sigleß | KN Mattersburg | 0,48 | 0,0474 | 0,0017 | 0,48 | 0,0474 | 0,0026 | 0,67 | 0,0663 | 0,0038 | 0,68 | 0,0663 | 0,0060 | 0,99 | 0,0758 | 0,0048 | 0,99 | 0,0758 | 0,0076 |
| S04- | Bad Sauerbrunn | Sigleß | 1,12 | 0,1107 | 0,0039 | 1,12 | 0,1107 | 0,0061 | 1,58 | 0,1549 | 0,0089 | 1,58 | 0,1549 | 0,0140 | 2,31 | 0,1771 | 0,0112 | 2,31 | 0,1771 | 0,0177 |
| S04- | | | | | | | | | | | | | | | | | | | | |

| | | | | | | | | | | | | | | | | | | | | |
|------|-----------------------------------|-----------------------------------|------|--------|--------|------|--------|--------|-------|--------|--------|-------|--------|--------|-------|--------|--------|-------|--------|--------|
| S06- | Gloggnitz | Neunkirchen | 2,47 | 0,2434 | 0,0085 | 2,47 | 0,2434 | 0,0134 | 3,46 | 0,3408 | 0,0196 | 3,48 | 0,3408 | 0,0308 | 5,07 | 0,3894 | 0,0247 | 5,08 | 0,3894 | 0,0388 |
| S06- | Maria Schutz | Gloggnitz | 1,57 | 0,1551 | 0,0054 | 1,58 | 0,1551 | 0,0085 | 2,21 | 0,2172 | 0,0125 | 2,22 | 0,2172 | 0,0196 | 3,23 | 0,2482 | 0,0157 | 3,24 | 0,2482 | 0,0247 |
| S06- | Spital / Semmering | Maria Schutz | 1,34 | 0,1317 | 0,0046 | 1,34 | 0,1317 | 0,0072 | 1,87 | 0,1844 | 0,0106 | 1,88 | 0,1844 | 0,0167 | 2,74 | 0,2107 | 0,0134 | 2,75 | 0,2107 | 0,0210 |
| S06- | Mürzzuschlag Ost | Spital / Semmering | 1,12 | 0,1100 | 0,0039 | 1,12 | 0,1100 | 0,0061 | 1,57 | 0,1540 | 0,0089 | 1,57 | 0,1540 | 0,0139 | 2,29 | 0,1760 | 0,0112 | 2,30 | 0,1760 | 0,0175 |
| S06- | Mariazell, Mürzsteg, Mürzzuschlag | Mürzzuschlag Ost | 0,99 | 0,0975 | 0,0034 | 0,99 | 0,0975 | 0,0054 | 1,39 | 0,1365 | 0,0079 | 1,39 | 0,1365 | 0,0123 | 2,03 | 0,1560 | 0,0099 | 2,04 | 0,1560 | 0,0156 |
| S06- | Hönigsberg | Mariazell, Mürzsteg, Mürzzuschlag | 0,71 | 0,0695 | 0,0024 | 0,71 | 0,0695 | 0,0038 | 0,99 | 0,0974 | 0,0056 | 0,99 | 0,0974 | 0,0088 | 1,45 | 0,1113 | 0,0071 | 1,45 | 0,1113 | 0,0111 |
| S06- | Langenwang | Hönigsberg | 0,39 | 0,0385 | 0,0013 | 0,39 | 0,0385 | 0,0021 | 0,55 | 0,0538 | 0,0031 | 0,55 | 0,0538 | 0,0049 | 0,80 | 0,0615 | 0,0039 | 0,80 | 0,0615 | 0,0061 |
| S06- | Krieglach | Langenwang | 0,46 | 0,0457 | 0,0016 | 0,46 | 0,0457 | 0,0025 | 0,65 | 0,0640 | 0,0037 | 0,65 | 0,0640 | 0,0058 | 0,95 | 0,0731 | 0,0046 | 0,95 | 0,0731 | 0,0073 |
| S06- | Mitterdorf | Krieglach | 1,17 | 0,1155 | 0,0040 | 1,17 | 0,1155 | 0,0064 | 1,64 | 0,1616 | 0,0093 | 1,65 | 0,1616 | 0,0146 | 2,41 | 0,1847 | 0,0117 | 2,41 | 0,1847 | 0,0184 |
| S06- | Kindberg Ost | Mitterdorf | 1,19 | 0,1174 | 0,0041 | 1,19 | 0,1174 | 0,0065 | 1,67 | 0,1644 | 0,0095 | 1,68 | 0,1644 | 0,0149 | 2,45 | 0,1878 | 0,0119 | 2,45 | 0,1878 | 0,0187 |
| S06- | Kindberg West | Kindberg Ost | 0,26 | 0,0252 | 0,0009 | 0,26 | 0,0252 | 0,0014 | 0,36 | 0,0353 | 0,0020 | 0,36 | 0,0353 | 0,0032 | 0,53 | 0,0403 | 0,0026 | 0,53 | 0,0403 | 0,0040 |
| S06- | Kindberg Dörfel | Kindberg West | 0,26 | 0,0252 | 0,0009 | 0,26 | 0,0252 | 0,0014 | 0,36 | 0,0353 | 0,0020 | 0,36 | 0,0353 | 0,0032 | 0,52 | 0,0403 | 0,0026 | 0,53 | 0,0403 | 0,0040 |
| S06- | Allerheiligen Mürzhofen | Kindberg Dörfel | 0,58 | 0,0567 | 0,0020 | 0,58 | 0,0567 | 0,0031 | 0,81 | 0,0794 | 0,0046 | 0,81 | 0,0794 | 0,0072 | 1,18 | 0,0908 | 0,0058 | 1,18 | 0,0908 | 0,0090 |
| S06- | St. Marein | Allerheiligen Mürzhofen | 0,86 | 0,0852 | 0,0030 | 0,87 | 0,0852 | 0,0047 | 1,21 | 0,1193 | 0,0069 | 1,22 | 0,1193 | 0,0108 | 1,77 | 0,1363 | 0,0086 | 1,78 | 0,1363 | 0,0136 |
| S06- | Kapfenberg | St. Marein | 0,61 | 0,0604 | 0,0021 | 0,61 | 0,0604 | 0,0033 | 0,86 | 0,0846 | 0,0049 | 0,86 | 0,0846 | 0,0076 | 1,26 | 0,0966 | 0,0061 | 1,26 | 0,0966 | 0,0096 |
| S06- | KN Bruck/Mur | Kapfenberg | 1,14 | 0,1128 | 0,0039 | 1,15 | 0,1128 | 0,0062 | 1,61 | 0,1579 | 0,0091 | 1,61 | 0,1579 | 0,0143 | 2,35 | 0,1804 | 0,0114 | 2,36 | 0,1804 | 0,0180 |
| S06- | ASt Bruck/Mur | KN Bruck/Mur | 0,98 | 0,0967 | 0,0034 | 0,98 | 0,0967 | 0,0053 | 1,38 | 0,1354 | 0,0078 | 1,38 | 0,1354 | 0,0122 | 2,02 | 0,1548 | 0,0098 | 2,02 | 0,1548 | 0,0154 |
| S06- | Niklasdorf | ASt Bruck/Mur | 0,91 | 0,0894 | 0,0031 | 0,91 | 0,0894 | 0,0049 | 1,27 | 0,1251 | 0,0072 | 1,28 | 0,1251 | 0,0113 | 1,86 | 0,1430 | 0,0091 | 1,87 | 0,1430 | 0,0143 |
| S06- | Leoben Ost | Niklasdorf | 0,97 | 0,0953 | 0,0033 | 0,97 | 0,0953 | 0,0052 | 1,36 | 0,1334 | 0,0077 | 1,36 | 0,1334 | 0,0121 | 1,99 | 0,1525 | 0,0097 | 1,99 | 0,1525 | 0,0152 |
| S06- | Leoben West | Leoben Ost | 1,08 | 0,1068 | 0,0037 | 1,09 | 0,1068 | 0,0059 | 1,52 | 0,1495 | 0,0086 | 1,52 | 0,1495 | 0,0135 | 2,22 | 0,1708 | 0,0108 | 2,23 | 0,1708 | 0,0170 |
| S06- | KN St. Michael | Leoben West | 1,34 | 0,1322 | 0,0046 | 1,34 | 0,1322 | 0,0073 | 1,88 | 0,1851 | 0,0106 | 1,89 | 0,1851 | 0,0167 | 2,75 | 0,2115 | 0,0134 | 2,76 | 0,2115 | 0,0211 |
| S10- | Neumarkt | Unterweikersdorf | 1,36 | 0,1339 | 0,0047 | 1,36 | 0,1339 | 0,0074 | 1,91 | 0,1875 | 0,0108 | 1,91 | 0,1875 | 0,0169 | 2,79 | 0,2143 | 0,0136 | 2,80 | 0,2143 | 0,0214 |
| S10- | Kefermarkt | Neumarkt | 0,78 | 0,0769 | 0,0027 | 0,78 | 0,0769 | 0,0042 | 1,09 | 0,1077 | 0,0062 | 1,10 | 0,1077 | 0,0097 | 1,60 | 0,1231 | 0,0078 | 1,61 | 0,1231 | 0,0123 |
| S10- | Freistadt / Süd | Kefermarkt | 0,84 | 0,0827 | 0,0029 | 0,84 | 0,0827 | 0,0046 | 1,18 | 0,1158 | 0,0067 | 1,18 | 0,1158 | 0,0105 | 1,72 | 0,1324 | 0,0084 | 1,73 | 0,1324 | 0,0132 |
| S10- | Grünbach Sandl | Freistadt / Süd | 0,89 | 0,0875 | 0,0031 | 0,89 | 0,0875 | 0,0048 | 1,25 | 0,1225 | 0,0070 | 1,25 | 0,1225 | 0,0111 | 1,82 | 0,1400 | 0,0089 | 1,83 | 0,1400 | 0,0140 |
| S10- | Freistadt / Nord | Grünbach Sandl | 0,24 | 0,0240 | 0,0008 | 0,24 | 0,0240 | 0,0013 | 0,34 | 0,0337 | 0,0019 | 0,34 | 0,0337 | 0,0030 | 0,50 | 0,0385 | 0,0024 | 0,50 | 0,0385 | 0,0038 |
| S16- | Landeck West | Zams | 1,04 | 0,1023 | 0,0036 | 1,04 | 0,1023 | 0,0056 | 1,46 | 0,1432 | 0,0082 | 1,46 | 0,1432 | 0,0129 | 2,13 | 0,1637 | 0,0104 | 2,14 | 0,1637 | 0,0163 |
| S16- | Pians | Landeck West | 0,66 | 0,0655 | 0,0023 | 0,67 | 0,0655 | 0,0036 | 0,93 | 0,0917 | 0,0053 | 0,94 | 0,0917 | 0,0083 | 1,37 | 0,1048 | 0,0067 | 1,37 | 0,1048 | 0,0105 |
| S16- | Flirsch | Pians | 1,32 | 0,1299 | 0,0045 | 1,32 | 0,1299 | 0,0071 | 1,85 | 0,1818 | 0,0105 | 1,85 | 0,1818 | 0,0164 | 2,71 | 0,2078 | 0,0132 | 2,71 | 0,2078 | 0,0207 |
| S16- | Schnann am Arlberg | Flirsch | 0,83 | 0,0815 | 0,0029 | 0,83 | 0,0815 | 0,0045 | 1,16 | 0,1141 | 0,0066 | 1,16 | 0,1141 | 0,0103 | 1,70 | 0,1304 | 0,0083 | 1,70 | 0,1304 | 0,0130 |
| S16- | Pettneu | Schnann am Arlberg | 0,60 | 0,0593 | 0,0021 | 0,60 | 0,0593 | 0,0033 | 0,84 | 0,0830 | 0,0048 | 0,85 | 0,0830 | 0,0075 | 1,23 | 0,0948 | 0,0060 | 1,24 | 0,0948 | 0,0095 |
| S16- | St. Anton/Arlberg | Pettneu | 0,33 | 0,0330 | 0,0012 | 0,34 | 0,0330 | 0,0018 | 0,47 | 0,0462 | 0,0027 | 0,47 | 0,0462 | 0,0042 | 0,69 | 0,0528 | 0,0033 | 0,69 | 0,0528 | 0,0053 |
| S16- | Langen/Arlberg | St. Anton/Arlberg | 8,11 | 0,3211 | 0,0112 | 8,11 | 0,3211 | 0,0177 | 11,36 | 0,4495 | 0,0258 | 11,37 | 0,4495 | 0,0406 | 16,87 | 0,5137 | 0,0326 | 16,89 | 0,5137 | 0,0512 |
| S16- | Wald/Arlberg | Langen/Arlberg | 1,07 | 0,1052 | 0,0037 | 1,07 | 0,1052 | 0,0058 | 1,50 | 0,1472 | 0,0085 | 1,50 | 0,1472 | 0,0133 | 2,19 | 0,1683 | 0,0107 | 2,20 | 0,1683 | 0,0168 |
| S16- | Dalaas | Wald/Arlberg | 1,22 | 0,1198 | 0,0042 | 1,22 | 0,1198 | 0,0066 | 1,71 | 0,1677 | 0,0096 | 1,71 | 0,1677 | 0,0152 | 2,50 | 0,1916 | 0,0122 | 2,50 | 0,1916 | 0,0191 |
| S16- | Braz Ost | Dalaas | 0,69 | 0,0679 | 0,0024 | 0,69 | 0,0679 | 0,0037 | 0,97 | 0,0951 | 0,0055 | 0,97 | 0,0951 | 0,0086 | 1,41 | 0,1086 | 0,0069 | 1,42 | 0,1086 | 0,0108 |
| S16- | Braz West | Braz Ost | 0,54 | 0,0530 | 0,0019 | 0,54 | 0,0530 | 0,0029 | 0,75 | 0,0742 | 0,0043 | 0,76 | 0,0742 | 0,0067 | 1,10 | 0,0848 | 0,0054 | 1,11 | 0,0848 | 0,0085 |
| S16- | Bings | Braz West | 0,73 | 0,0718 | 0,0025 | 0,73 | 0,0718 | 0,0039 | 1,02 | 0,1005 | 0,0058 | 1,03 | 0,1005 | 0,0091 | 1,50 | 0,1148 | 0,0073 | 1,50 | 0,1148 | 0,0114 |
| S16- | Bludenz Montafon | Bings | 0,34 | 0,0340 | 0,0012 | 0,35 | 0,0340 | 0,0019 | 0,48 | 0,0476 | 0,0027 | 0,49 | 0,0476 | 0,0043 | 0,71 | 0,0544 | 0,0034 | 0,71 | 0,0544 | 0,0054 |
| S31- | Eisenstadt Süd | Eisenstadt Ost | 0,62 | 0,0616 | 0,0022 | 0,63 | 0,0616 | 0,0034 | 0,88 | 0,0862 | 0,0050 | 0,88 | 0,0862 | 0,0078 | 1,28 | 0,0985 | 0,0063 | 1,29 | 0,0985 | 0,0098 |
| S31- | Eisenstadt Mitte | Eisenstadt Süd | 0,23 | 0,0231 | 0,0008 | 0,23 | 0,0231 | 0,0013 | 0,33 | 0,0323 | 0,0019 | 0,33 | 0,0323 | 0,0029 | 0,48 | 0,0369 | 0,0023 | 0,48 | 0,0369 | 0,0037 |
| S31- | KN Eisenstadt | Eisenstadt Mitte | 0,39 | 0,0380 | 0,0013 | 0,39 | 0,0380 | 0,0021 | 0,54 | 0,0533 | 0,0031 | 0,54 | 0,0533 | 0,0048 | 0,79 | 0,0609 | 0,0039 | 0,79 | 0,0609 | 0,0061 |
| S31- | Wulkaprodersdorf | KN Eisenstadt | 0,51 | 0,0506 | 0,0018 | 0,51 | 0,0506 | 0,0028 | 0,72 | 0,0709 | 0,0041 | 0,72 | 0,0709 | 0,0064 | 1,05 | 0,0810 | 0,0051 | 1,06 | 0,0810 | 0,0081 |
| S31- | KN Mattersburg | Wulkaprodersdorf | 1,46 | 0,1438 | 0,0050 | 1,46 | 0,1438 | 0,0079 | 2,05 | 0,2013 | 0,0116 | 2,05 | 0,2013 | 0,0182 | 2,99 | 0,2300 | 0,0146 | 3,00 | 0,2300 | 0,0229 |
| S31- | Forchtenstein | KN Mattersburg | 1,06 | 0,1041 | 0,0036 | 1,06 | 0,1041 | 0,0057 | 1,48 | 0,1457 | 0,0084 | 1,49 | 0,1457 | 0,0132 | 2,17 | 0,1665 | 0,0106 | 2,17 | 0,1665 | 0,0166 |
| S31- | Sieggraben | Forchtenstein | 1,48 | 0,1454 | 0,0051 | 1,48 | 0,1454 | 0,0080 | 2,07 | 0,2036 | 0,0117 | 2,08 | 0,2036 | 0,0184 | 3,03 | 0,2326 | 0,0148 | 3,04 | 0,2326 | 0,0232 |
| S31- | Weppersdorf/Kobersdorf | Sieggraben | 1,78 | 0,1752 | 0,0061 | 1,78 | 0,1752 | 0,0096 | 2,49 | 0,2452 | 0,0141 | 2,50 | 0,2452 | 0,0222 | 3,65 | 0,2803 | 0,0178 | 3,66 | 0,2803 | 0,0279 |
| S31- | Weppersdorf/Markt St.Martin | Weppersdorf/Kobersdorf | 0,37 | 0,0360 | 0,0013 | 0,37 | 0,0360 | 0,0020 | 0,51 | 0,0504 | 0,0029 | 0,51 | 0,0504 | 0,0046 | 0,75 | 0,0576 | 0,0037 | 0,75 | 0,0576 | 0,0057 |
| S31- | Neutal | Weppersdorf/Markt St.Martin | 0,84 | 0,0831 | 0,0029 | 0,85 | 0,0831 | 0,0046 | 1,18 | 0,1164 | 0,0067 | 1,19 | 0,1164 | 0,0105 | 1,73 | 0,1330 | 0,0084 | 1,74 | 0,1330 | 0,0133 |
| S31- | Stoob Süd | Neutal | 0,74 | 0,0726 | 0,0025 | 0,74 | 0,0726 | 0,0040 | 1,03 | 0,1017 | 0,0058 | 1,04 | 0,1017 | 0,0092 | 1,51 | 0,1162 | 0,0074 | 1,52 | 0,1162 | 0,0116 |
| S31- | Oberpullendorf | Stoob Süd | 0,80 | 0,0793 | 0,0028 | 0,81 | 0,0793 | 0,0044 | 1,13 | 0,1110 | 0,0064 | 1,13 | 0,1110 | 0,0100 | 1,65 | 0,1269 | 0,0080 | 1,66 | 0,1269 | 0,0126 |
| S33- | St. Pölten Ost | KN St. Pölten | 0,44 | 0,0430 | 0,0015 | 0,44 | 0,0430 | 0,0024 | 0,61 | 0,0603 | 0,0035 | 0,61 | 0,0603 | 0,0054 | 0,90 | 0,0689 | 0,0044 | 0,90 | 0,0689 | 0,0069 |
| S33- | St. Pölten Nord | St. Pölten Ost | 0,77 | 0,0761 | 0,0027 | 0,77 | 0,0761 | 0,0042 | 1,08 | 0,1065 | 0,0061 | 1,09 | 0,1065 | 0,0096 | 1,58 | 0,1217 | 0,0077 | 1,59 | 0,1217 | 0,0121 |
| S33- | Herzogenburg Süd | St. Pölten Nord | 0,82 | 0,0805 | 0,0028 | 0,82 | 0,0805 | 0,0044 | 1,15 | 0,1128 | 0,0065 | 1,15 | 0,1128 | 0,0102 | 1,68 | 0,1289 | 0,0082 | 1,68 | 0,1289 | 0,0128 |
| S33- | Herzogenburg Stadt | Herzogenburg Süd | 0,44 | 0,0430 | 0,0015 | 0,44 | 0,0430 | 0,0024 | 0,61 | 0,0602 | 0,0035 | 0,61 | 0,0602 | 0,0054 | 0,90 | 0,0688 | 0,0044 | 0,90 | 0,0688 | 0,0069 |
| S33- | Herzogenburg Nord | Herzogenburg Stadt | 0,24 | 0,0238 | 0,0008 | 0,24 | 0,0238 | 0,0013 | 0,34 | 0,0334 | 0,0019 | 0,34 | 0,0334 | 0,0030 | 0,50 | 0,0381 | 0,0024 | 0,50 | 0,0381 | 0,0038 |
| S33- | Traismauer Süd | Herzogenburg Nord | 1,18 | 0,1160 | 0,0041 | 1,18 | 0,1160 | 0,0064 | 1,65 | | | | | | | | | | | |

| | | | | | | | | | | | | | | | | | | | | |
|------|--------------------------|--------------------------|------|--------|--------|------|--------|--------|------|--------|--------|------|--------|--------|------|--------|--------|------|--------|--------|
| S36- | Zeltweg Ost Spielberg | Knittelfeld West | 0,19 | 0,0185 | 0,0006 | 0,19 | 0,0185 | 0,0010 | 0,26 | 0,0259 | 0,0015 | 0,26 | 0,0259 | 0,0023 | 0,39 | 0,0296 | 0,0019 | 0,39 | 0,0296 | 0,0030 |
| S36- | Zeltweg West | Zeltweg Ost Spielberg | 1,22 | 0,1204 | 0,0042 | 1,22 | 0,1204 | 0,0066 | 1,71 | 0,1686 | 0,0097 | 1,72 | 0,1686 | 0,0152 | 2,51 | 0,1926 | 0,0122 | 2,52 | 0,1926 | 0,0192 |
| S36- | Judenburg Ost Fohnsdorf | Zeltweg West | 0,61 | 0,0605 | 0,0021 | 0,62 | 0,0605 | 0,0033 | 0,86 | 0,0848 | 0,0049 | 0,86 | 0,0848 | 0,0077 | 1,26 | 0,0969 | 0,0061 | 1,26 | 0,0969 | 0,0097 |
| S36- | Judenburg West | Judenburg Ost Fohnsdorf | 0,95 | 0,0939 | 0,0033 | 0,95 | 0,0939 | 0,0052 | 1,34 | 0,1315 | 0,0076 | 1,34 | 0,1315 | 0,0119 | 1,96 | 0,1503 | 0,0095 | 1,96 | 0,1503 | 0,0150 |
| S36- | St. Georgen Ost | As B317 (prov.) | 0,10 | 0,0098 | 0,0003 | 0,10 | 0,0098 | 0,0005 | 0,14 | 0,0137 | 0,0008 | 0,14 | 0,0137 | 0,0012 | 0,20 | 0,0157 | 0,0010 | 0,21 | 0,0157 | 0,0016 |
| S36- | St. Georgen West | St. Georgen Ost | 0,18 | 0,0182 | 0,0006 | 0,18 | 0,0182 | 0,0010 | 0,26 | 0,0255 | 0,0015 | 0,26 | 0,0255 | 0,0023 | 0,38 | 0,0291 | 0,0018 | 0,38 | 0,0291 | 0,0029 |
| S37- | St. Veit Mitte / Brückl | St. Veit Nord | 0,58 | 0,0570 | 0,0020 | 0,58 | 0,0570 | 0,0031 | 0,81 | 0,0797 | 0,0046 | 0,81 | 0,0797 | 0,0072 | 1,19 | 0,0911 | 0,0058 | 1,19 | 0,0911 | 0,0091 |
| S37- | St. Veit Süd | St. Veit Mitte / Brückl | 0,49 | 0,0484 | 0,0017 | 0,49 | 0,0484 | 0,0027 | 0,69 | 0,0678 | 0,0039 | 0,69 | 0,0678 | 0,0061 | 1,01 | 0,0775 | 0,0049 | 1,01 | 0,0775 | 0,0077 |
| S37- | St. Veit Industriegebiet | St. Veit Süd | 0,37 | 0,0364 | 0,0013 | 0,37 | 0,0364 | 0,0020 | 0,52 | 0,0510 | 0,0029 | 0,52 | 0,0510 | 0,0046 | 0,76 | 0,0582 | 0,0037 | 0,76 | 0,0582 | 0,0058 |
| S37- | Maria Saal | St. Veit Industriegebiet | 1,30 | 0,1278 | 0,0045 | 1,30 | 0,1278 | 0,0070 | 1,82 | 0,1789 | 0,0103 | 1,82 | 0,1789 | 0,0162 | 2,66 | 0,2044 | 0,0130 | 2,67 | 0,2044 | 0,0204 |
| S37- | Karnburg | Maria Saal | 0,46 | 0,0456 | 0,0016 | 0,46 | 0,0456 | 0,0025 | 0,65 | 0,0639 | 0,0037 | 0,65 | 0,0639 | 0,0058 | 0,95 | 0,0730 | 0,0046 | 0,95 | 0,0730 | 0,0073 |
| S37- | Klagenfurt Nord | Karnburg | 0,40 | 0,0398 | 0,0014 | 0,40 | 0,0398 | 0,0022 | 0,57 | 0,0557 | 0,0032 | 0,57 | 0,0557 | 0,0050 | 0,83 | 0,0637 | 0,0040 | 0,83 | 0,0637 | 0,0064 |

| Road | Toll road section from | Toll road section to | EURO V Cat 2 | | | | | | EURO V Cat 3 | | | | | | EURO V Cat 4 | | | | | |
|------|----------------------------|----------------------------|--------------|--------|--------|-------|--------|--------|--------------|--------|--------|-------|--------|--------|--------------|--------|--------|-------|--------|--------|
| | | | Unit Price | | | | | | Unit Price | | | | | | Unit Price | | | | | |
| | | | Day | | | Night | | | Day | | | Night | | | Day | | | Night | | |
| | | | Sum | Air | Noise | Sum | Air | Noise | Sum | Air | Noise | Sum | Air | Noise | Sum | Air | Noise | Sum | Air | Noise |
| A01- | Wien Auhof | Preßbaum | 2,74 | 0,1908 | 0,0098 | 2,74 | 0,1908 | 0,0153 | 3,84 | 0,2672 | 0,0224 | 3,86 | 0,2672 | 0,0352 | 5,66 | 0,3053 | 0,0283 | 5,68 | 0,3053 | 0,0444 |
| A01- | Preßbaum | KN Steinhäusl | 1,55 | 0,1078 | 0,0055 | 1,55 | 0,1078 | 0,0087 | 2,17 | 0,1510 | 0,0127 | 2,18 | 0,1510 | 0,0199 | 3,20 | 0,1726 | 0,0160 | 3,21 | 0,1726 | 0,0251 |
| A01- | KN Steinhäusl | Altengbach | 0,91 | 0,0634 | 0,0032 | 0,91 | 0,0634 | 0,0051 | 1,28 | 0,0888 | 0,0075 | 1,28 | 0,0888 | 0,0117 | 1,88 | 0,1014 | 0,0094 | 1,89 | 0,1014 | 0,0148 |
| A01- | Altengbach | St. Christophen | 1,09 | 0,0756 | 0,0039 | 1,09 | 0,0756 | 0,0061 | 1,52 | 0,1059 | 0,0089 | 1,53 | 0,1059 | 0,0140 | 2,24 | 0,1210 | 0,0112 | 2,25 | 0,1210 | 0,0176 |
| A01- | St. Christophen | Böheimkirchen | 1,30 | 0,0907 | 0,0046 | 1,30 | 0,0907 | 0,0073 | 1,83 | 0,1270 | 0,0107 | 1,83 | 0,1270 | 0,0167 | 2,69 | 0,1451 | 0,0134 | 2,70 | 0,1451 | 0,0211 |
| A01- | Böheimkirchen | KN St. Pölten | 1,27 | 0,0887 | 0,0045 | 1,28 | 0,0887 | 0,0071 | 1,79 | 0,1242 | 0,0104 | 1,79 | 0,1242 | 0,0164 | 2,63 | 0,1419 | 0,0131 | 2,64 | 0,1419 | 0,0207 |
| A01- | KN St. Pölten | St. Pölten Süd | 0,90 | 0,0629 | 0,0032 | 0,90 | 0,0629 | 0,0051 | 1,27 | 0,0881 | 0,0074 | 1,27 | 0,0881 | 0,0116 | 1,87 | 0,1007 | 0,0093 | 1,87 | 0,1007 | 0,0147 |
| A01- | St. Pölten Süd | Loosdorf | 3,13 | 0,2182 | 0,0111 | 3,14 | 0,2182 | 0,0175 | 4,39 | 0,3055 | 0,0256 | 4,41 | 0,3055 | 0,0403 | 6,48 | 0,3491 | 0,0323 | 6,49 | 0,3491 | 0,0508 |
| A01- | Loosdorf | Melk | 1,15 | 0,0800 | 0,0041 | 1,15 | 0,0800 | 0,0064 | 1,61 | 0,1119 | 0,0094 | 1,62 | 0,1119 | 0,0148 | 2,37 | 0,1279 | 0,0118 | 2,38 | 0,1279 | 0,0186 |
| A01- | Melk | Pöchlarn | 2,03 | 0,1417 | 0,0072 | 2,04 | 0,1417 | 0,0114 | 2,85 | 0,1984 | 0,0167 | 2,86 | 0,1984 | 0,0262 | 4,21 | 0,2268 | 0,0210 | 4,22 | 0,2268 | 0,0330 |
| A01- | Pöchlarn | Ybbs Wieselburg | 1,88 | 0,1308 | 0,0067 | 1,88 | 0,1308 | 0,0105 | 2,63 | 0,1831 | 0,0154 | 2,64 | 0,1831 | 0,0242 | 3,88 | 0,2093 | 0,0194 | 3,89 | 0,2093 | 0,0305 |
| A01- | Ybbs Wieselburg | Amstetten Ost | 1,69 | 0,1175 | 0,0060 | 1,69 | 0,1175 | 0,0094 | 2,37 | 0,1645 | 0,0138 | 2,37 | 0,1645 | 0,0217 | 3,49 | 0,1881 | 0,0174 | 3,50 | 0,1881 | 0,0274 |
| A01- | Amstetten Ost | Amstetten West | 2,65 | 0,1849 | 0,0094 | 2,66 | 0,1849 | 0,0148 | 3,72 | 0,2588 | 0,0217 | 3,73 | 0,2588 | 0,0341 | 5,49 | 0,2958 | 0,0274 | 5,50 | 0,2958 | 0,0430 |
| A01- | Amstetten West | Oed | 1,86 | 0,1298 | 0,0066 | 1,87 | 0,1298 | 0,0104 | 2,61 | 0,1817 | 0,0153 | 2,62 | 0,1817 | 0,0240 | 3,85 | 0,2077 | 0,0192 | 3,86 | 0,2077 | 0,0302 |
| A01- | Oed | Haag | 2,01 | 0,1401 | 0,0072 | 2,01 | 0,1401 | 0,0112 | 2,82 | 0,1961 | 0,0165 | 2,83 | 0,1961 | 0,0259 | 4,16 | 0,2241 | 0,0208 | 4,17 | 0,2241 | 0,0326 |
| A01- | Haag | St. Valentin | 1,79 | 0,1247 | 0,0064 | 1,79 | 0,1247 | 0,0100 | 2,51 | 0,1746 | 0,0147 | 2,52 | 0,1746 | 0,0230 | 3,70 | 0,1996 | 0,0185 | 3,71 | 0,1996 | 0,0290 |
| A01- | St. Valentin | Enns Steyr | 0,76 | 0,0529 | 0,0027 | 0,76 | 0,0529 | 0,0042 | 1,06 | 0,0740 | 0,0062 | 1,07 | 0,0740 | 0,0098 | 1,57 | 0,0846 | 0,0078 | 1,57 | 0,0846 | 0,0123 |
| A01- | Enns Steyr | Enns West | 0,59 | 0,0410 | 0,0021 | 0,59 | 0,0410 | 0,0033 | 0,83 | 0,0574 | 0,0048 | 0,83 | 0,0574 | 0,0076 | 1,22 | 0,0656 | 0,0061 | 1,22 | 0,0656 | 0,0096 |
| A01- | Enns West | Asten St Florian | 0,46 | 0,0319 | 0,0016 | 0,46 | 0,0319 | 0,0026 | 0,64 | 0,0446 | 0,0037 | 0,64 | 0,0446 | 0,0059 | 0,95 | 0,0510 | 0,0047 | 0,95 | 0,0510 | 0,0074 |
| A01- | Asten St Florian | KN Linz | 1,75 | 0,1220 | 0,0098 | 1,75 | 0,1220 | 0,0098 | 2,46 | 0,1708 | 0,0143 | 2,46 | 0,1708 | 0,0225 | 3,62 | 0,1952 | 0,0181 | 3,63 | 0,1952 | 0,0284 |
| A01- | KN Linz | Ansfelden | 0,30 | 0,0206 | 0,0011 | 0,30 | 0,0206 | 0,0017 | 0,41 | 0,0288 | 0,0024 | 0,42 | 0,0288 | 0,0038 | 0,61 | 0,0329 | 0,0030 | 0,61 | 0,0329 | 0,0048 |
| A01- | Ansfelden | Traun | 0,65 | 0,0455 | 0,0023 | 0,65 | 0,0455 | 0,0037 | 0,92 | 0,0637 | 0,0053 | 0,92 | 0,0637 | 0,0084 | 1,35 | 0,0728 | 0,0067 | 1,35 | 0,0728 | 0,0106 |
| A01- | Traun | KN A1/A25 Passau Wels | 0,31 | 0,0214 | 0,0011 | 0,31 | 0,0214 | 0,0017 | 0,43 | 0,0300 | 0,0025 | 0,43 | 0,0300 | 0,0040 | 0,64 | 0,0342 | 0,0032 | 0,64 | 0,0342 | 0,0050 |
| A01- | KN A1/A25 Passau Wels | Allhaming | 1,42 | 0,0987 | 0,0050 | 1,42 | 0,0987 | 0,0079 | 1,99 | 0,1382 | 0,0116 | 1,99 | 0,1382 | 0,0182 | 2,93 | 0,1580 | 0,0146 | 2,94 | 0,1580 | 0,0230 |
| A01- | Allhaming | Sattledt | 2,36 | 0,1647 | 0,0084 | 2,37 | 0,1647 | 0,0132 | 3,32 | 0,2306 | 0,0194 | 3,33 | 0,2306 | 0,0304 | 4,89 | 0,2636 | 0,0244 | 4,90 | 0,2636 | 0,0384 |
| A01- | Sattledt | KN Voralpenkreuz | 0,30 | 0,0207 | 0,0011 | 0,30 | 0,0207 | 0,0017 | 0,42 | 0,0290 | 0,0024 | 0,42 | 0,0290 | 0,0038 | 0,62 | 0,0332 | 0,0031 | 0,62 | 0,0332 | 0,0048 |
| A01- | KN Voralpenkreuz | Eberstalzell | 0,86 | 0,0596 | 0,0030 | 0,86 | 0,0596 | 0,0048 | 1,20 | 0,0835 | 0,0070 | 1,20 | 0,0835 | 0,0110 | 1,77 | 0,0954 | 0,0088 | 1,77 | 0,0954 | 0,0139 |
| A01- | Eberstalzell | Vorchdorf | 1,29 | 0,0899 | 0,0046 | 1,29 | 0,0899 | 0,0072 | 1,81 | 0,1259 | 0,0106 | 1,82 | 0,1259 | 0,0166 | 2,67 | 0,1439 | 0,0133 | 2,68 | 0,1439 | 0,0209 |
| A01- | Vorchdorf | Laakirchen Ost | 1,13 | 0,0788 | 0,0040 | 1,13 | 0,0788 | 0,0063 | 1,59 | 0,1103 | 0,0093 | 1,59 | 0,1103 | 0,0146 | 2,34 | 0,1261 | 0,0117 | 2,34 | 0,1261 | 0,0183 |
| A01- | Laakirchen Ost | Laakirchen West | 0,71 | 0,0496 | 0,0025 | 0,71 | 0,0496 | 0,0040 | 1,00 | 0,0694 | 0,0058 | 1,00 | 0,0694 | 0,0092 | 1,47 | 0,0794 | 0,0073 | 1,48 | 0,0794 | 0,0115 |
| A01- | Laakirchen West | Regau | 1,40 | 0,0972 | 0,0050 | 1,40 | 0,0972 | 0,0078 | 1,96 | 0,1361 | 0,0114 | 1,96 | 0,1361 | 0,0180 | 2,89 | 0,1555 | 0,0144 | 2,89 | 0,1555 | 0,0226 |
| A01- | Regau | Schörfling | 1,83 | 0,1277 | 0,0065 | 1,84 | 0,1277 | 0,0103 | 2,57 | 0,1788 | 0,0150 | 2,58 | 0,1788 | 0,0236 | 3,79 | 0,2044 | 0,0189 | 3,80 | 0,2044 | 0,0297 |
| A01- | Schörfling | Seewalchen | 0,28 | 0,0198 | 0,0010 | 0,28 | 0,0198 | 0,0016 | 0,40 | 0,0277 | 0,0023 | 0,40 | 0,0277 | 0,0037 | 0,59 | 0,0317 | 0,0029 | 0,59 | 0,0317 | 0,0046 |
| A01- | Seewalchen | St. Georgen | 1,66 | 0,1158 | 0,0059 | 1,67 | 0,1158 | 0,0093 | 2,33 | 0,1621 | 0,0136 | 2,34 | 0,1621 | 0,0214 | 3,44 | 0,1853 | 0,0172 | 3,45 | 0,1853 | 0,0270 |
| A01- | St. Georgen | Oberwang | 2,22 | 0,1544 | 0,0079 | 2,22 | 0,1544 | 0,0124 | 3,11 | 0,2162 | 0,0181 | 3,12 | 0,2162 | 0,0285 | 4,58 | 0,2470 | 0,0229 | 4,60 | 0,2470 | 0,0360 |
| A01- | Oberwang | Mondsee | 2,04 | 0,1421 | 0,0073 | 2,04 | 0,1421 | 0,0114 | 2,86 | 0,1990 | 0,0167 | 2,87 | 0,1990 | 0,0262 | 4,22 | 0,2274 | 0,0211 | 4,23 | 0,2274 | 0,0331 |
| A01- | Mondsee | Thalgau | 1,88 | 0,1310 | 0,0067 | 1,88 | 0,1310 | 0,0105 | 2,64 | 0,1834 | 0,0154 | 2,65 | 0,1834 | 0,0242 | 3,89 | 0,2096 | 0,0194 | 3,90 | 0,2096 | 0,0305 |
| A01- | Thalgau | Wallersee | 1,43 | 0,0998 | 0,0051 | 1,44 | 0,0998 | 0,0080 | 2,01 | 0,1398 | 0,0117 | 2,02 | 0,1398 | 0,0184 | 2,96 | 0,1597 | 0,0148 | 2,97 | 0,1597 | 0,0232 |
| A01- | Wallersee | Salzburg Nord | 1,39 | 0,0966 | 0,0049 | 1,39 | 0,0966 | 0,0078 | 1,95 | 0,1353 | 0,0114 | 1,95 | 0,1353 | 0,0178 | 2,87 | 0,1546 | 0,0143 | 2,88 | 0,1546 | 0,0225 |
| A01- | Salzburg Nord | Salzburg Bergheim-West | 0,31 | 0,0218 | 0,0011 | 0,31 | 0,0218 | 0,0017 | 0,44 | 0,0305 | 0,0026 | 0,44 | 0,0305 | 0,0040 | 0,65 | 0,0349 | 0,0032 | 0,65 | 0,0349 | 0,0051 |
| A01- | Salzburg Bergheim-West | Messe | 0,15 | 0,0104 | 0,0005 | 0,15 | 0,0104 | 0,0008 | 0,21 | 0,0146 | 0,0012 | 0,21 | 0,0146 | 0,0019 | 0,31 | 0,0167 | 0,0015 | 0,31 | 0,0167 | 0,0024 |
| A01- | Messe | Salzburg Mitte Freilassing | 0,20 | 0,0139 | 0,0007 | 0,20 | 0,0139 | 0,0011 | 0,28 | 0,0194 | 0,0016 | 0,28 | 0,0194 | 0,0026 | 0,41 | 0,0222 | 0,0021 | 0,41 | 0,0222 | 0,0032 |
| A01- | Salzburg Mitte Freilassing | Kleßheim | 0,24 | 0,0170 | 0,0009 | 0,24 | 0,0170 | 0,0014 | 0,34 | 0,0238 | 0,0020 | 0,34 | 0,0238 | 0,0031 | 0,51 | 0,0272 | 0,0025 | 0,51 | 0,0272 | 0,0040 |
| A01- | Kleßheim | Siezenheim | 0,34 | 0,0236 | 0,0012 | 0,34 | 0,0236 | 0,0019 | 0,48 | 0,0330 | 0,0028 | 0,48 | 0,0330 | 0,0044 | 0,70 | 0,0378 | 0,0035 | 0,70 | 0,0378 | 0,0055 |
| A01- | Siezenheim | Flughafen | 0,17 | 0,0119 | 0,0006 | 0,17 | 0,0119 | 0,0010 | 0,24 | 0,0166 | 0,0014 | 0,24 | 0,0166 | 0,0022 | 0,35 | 0,0190 | 0,0018 | 0,35 | 0,0190 | 0,0028 |
| A01- | Flughafen | Wals Salzburg West | 0,21 | 0,0145 | 0,0007 | 0,21 | 0,0145 | 0,0012 | 0,29 | 0,0203 | 0,0017 | 0,29 | 0,0203 | 0,0027 | 0,43 | 0,0232 | 0,0021 | 0,43 | 0,0232 | 0,0034 |
| A01- | Wals Salzburg West | KN Salzburg | 0,31 | 0,0217 | 0,0011 | 0,31 | 0,0217 | 0,0017 | 0,44 | 0,0304 | 0,0026 | 0,44 | 0,0304 | 0,0040 | 0,64 | 0,0347 | 0,0032 | 0,65 | 0,0347 | 0,0051 |
| A01- | KN Salzburg | Staatsgrenze Walsberg | 0,53 | 0,0369 | 0,0019 | 0,53 | 0,0369 | 0,0030 | 0,74 | 0,0517 | 0,0043 | 0,75 | 0,0517 | 0,0068 | 1,09 | 0,0590 | 0,0055 | 1,10 | 0,0590 | 0,0086 |
| A02- | KN Wien Inzersdorf | KN Vösendorf | 0,66 | 0,0462 | 0,0024 | 0,66 | 0,0462 | 0,0037 | 0,93 | 0,0646 | 0,0054 | 0,93 | 0,0646 | 0,0085 | 1,37 | 0,0739 | 0,0068 | 1,37 | 0,0739 | 0,0108 |
| A02- | KN Vösendorf | Mödling | 0,45 | 0,0314 | 0,0016 | 0,45 | 0,0314 | 0,0025 | 0,63 | 0,0439 | 0,0037 | 0,63 | 0,0439 | 0,0058 | 0,93 | 0,0502 | | | | |

| | | | | | | | | | | | | | | | | | | | | |
|------|----------------------------|----------------------------|------|--------|--------|------|--------|--------|------|--------|--------|------|--------|--------|------|--------|--------|------|--------|--------|
| A02- | Ilz Fürstenfeld | Sinabelkirchen | 2,21 | 0,1539 | 0,0079 | 2,21 | 0,1539 | 0,0124 | 3,10 | 0,2154 | 0,0181 | 3,11 | 0,2154 | 0,0284 | 4,57 | 0,2462 | 0,0228 | 4,58 | 0,2462 | 0,0358 |
| A02- | Sinabelkirchen | Gleisdorf Süd | 1,45 | 0,1014 | 0,0052 | 1,46 | 0,1014 | 0,0081 | 2,04 | 0,1419 | 0,0119 | 2,05 | 0,1419 | 0,0187 | 3,01 | 0,1622 | 0,0150 | 3,02 | 0,1622 | 0,0236 |
| A02- | Gleisdorf Süd | Gleisdorf West | 0,63 | 0,0440 | 0,0022 | 0,63 | 0,0440 | 0,0035 | 0,89 | 0,0616 | 0,0052 | 0,89 | 0,0616 | 0,0081 | 1,31 | 0,0704 | 0,0065 | 1,31 | 0,0704 | 0,0102 |
| A02- | Gleisdorf West | Laßnitzhöhe | 1,65 | 0,1153 | 0,0059 | 1,66 | 0,1153 | 0,0093 | 2,32 | 0,1614 | 0,0135 | 2,33 | 0,1614 | 0,0213 | 3,28 | 0,1845 | 0,0171 | 3,30 | 0,1845 | 0,0268 |
| A02- | Laßnitzhöhe | KN Graz Ost | 2,07 | 0,1442 | 0,0074 | 2,07 | 0,1442 | 0,0116 | 2,90 | 0,2019 | 0,0170 | 2,91 | 0,2019 | 0,0266 | 4,42 | 0,2308 | 0,0214 | 4,49 | 0,2308 | 0,0336 |
| A02- | KN Graz Ost | Graz Feldkirchen Flughafen | 0,74 | 0,0519 | 0,0027 | 0,75 | 0,0519 | 0,0042 | 1,05 | 0,0727 | 0,0061 | 1,05 | 0,0727 | 0,0096 | 1,54 | 0,0830 | 0,0077 | 1,54 | 0,0830 | 0,0121 |
| A02- | Graz Feldkirchen Flughafen | KN Graz West | 0,50 | 0,0347 | 0,0018 | 0,50 | 0,0347 | 0,0028 | 0,70 | 0,0486 | 0,0041 | 0,70 | 0,0486 | 0,0064 | 1,03 | 0,0556 | 0,0051 | 1,03 | 0,0556 | 0,0081 |
| A02- | KN Graz West | Unterpremstätten | 0,60 | 0,0418 | 0,0021 | 0,60 | 0,0418 | 0,0034 | 0,84 | 0,0585 | 0,0049 | 0,84 | 0,0585 | 0,0077 | 1,24 | 0,0668 | 0,0062 | 1,24 | 0,0668 | 0,0097 |
| A02- | Unterpremstätten | Lieboch | 0,93 | 0,0649 | 0,0033 | 0,93 | 0,0649 | 0,0052 | 1,31 | 0,0908 | 0,0076 | 1,31 | 0,0908 | 0,0120 | 1,93 | 0,1038 | 0,0096 | 1,93 | 0,1038 | 0,0151 |
| A02- | Lieboch | Mooskirchen | 1,28 | 0,0894 | 0,0046 | 1,29 | 0,0894 | 0,0072 | 1,80 | 0,1252 | 0,0105 | 1,81 | 0,1252 | 0,0165 | 2,65 | 0,1431 | 0,0133 | 2,66 | 0,1431 | 0,0208 |
| A02- | Mooskirchen | Steinberg | 1,33 | 0,0926 | 0,0047 | 1,33 | 0,0926 | 0,0074 | 1,86 | 0,1296 | 0,0109 | 1,87 | 0,1296 | 0,0171 | 2,75 | 0,1481 | 0,0137 | 2,76 | 0,1481 | 0,0216 |
| A02- | Steinberg | Modriach | 3,32 | 0,2314 | 0,0118 | 3,33 | 0,2314 | 0,0186 | 4,66 | 0,3240 | 0,0272 | 4,68 | 0,3240 | 0,0427 | 6,87 | 0,3702 | 0,0343 | 6,89 | 0,3702 | 0,0539 |
| A022 | KN Graz Ost | Puchwerk | 0,14 | 0,0097 | 0,0005 | 0,14 | 0,0097 | 0,0008 | 0,20 | 0,0136 | 0,0011 | 0,20 | 0,0136 | 0,0018 | 0,29 | 0,0155 | 0,0014 | 0,29 | 0,0155 | 0,0023 |
| A022 | Puchwerk | Graz Raaba | 0,20 | 0,0139 | 0,0007 | 0,20 | 0,0139 | 0,0011 | 0,28 | 0,0194 | 0,0016 | 0,28 | 0,0194 | 0,0026 | 0,41 | 0,0222 | 0,0021 | 0,41 | 0,0222 | 0,0032 |
| A022 | Graz Raaba | Graz Sternäckerweg | 0,29 | 0,0202 | 0,0010 | 0,29 | 0,0202 | 0,0016 | 0,41 | 0,0282 | 0,0024 | 0,41 | 0,0282 | 0,0037 | 0,60 | 0,0322 | 0,0030 | 0,60 | 0,0322 | 0,0047 |
| A02- | Modriach | Packsattel | 1,53 | 0,1066 | 0,0054 | 1,53 | 0,1066 | 0,0086 | 2,15 | 0,1492 | 0,0125 | 2,15 | 0,1492 | 0,0197 | 3,16 | 0,1705 | 0,0158 | 3,17 | 0,1705 | 0,0248 |
| A02- | Packsattel | Bad St. Leonhard | 1,86 | 0,1296 | 0,0066 | 1,86 | 0,1296 | 0,0104 | 2,61 | 0,1814 | 0,0152 | 2,62 | 0,1814 | 0,0239 | 3,85 | 0,2073 | 0,0192 | 3,86 | 0,2073 | 0,0302 |
| A02- | Bad St. Leonhard | Wolfsberg Nord | 2,19 | 0,1523 | 0,0078 | 2,19 | 0,1523 | 0,0122 | 3,07 | 0,2132 | 0,0179 | 3,08 | 0,2132 | 0,0281 | 4,52 | 0,2437 | 0,0226 | 4,53 | 0,2437 | 0,0355 |
| A02- | Wolfsberg Nord | Wolfsberg Süd | 0,62 | 0,0433 | 0,0022 | 0,62 | 0,0433 | 0,0035 | 0,87 | 0,0606 | 0,0051 | 0,87 | 0,0606 | 0,0080 | 1,28 | 0,0693 | 0,0064 | 1,29 | 0,0693 | 0,0101 |
| A02- | Wolfsberg Süd | St. Andrä | 1,83 | 0,1272 | 0,0065 | 1,83 | 0,1272 | 0,0102 | 2,56 | 0,1781 | 0,0149 | 2,57 | 0,1781 | 0,0235 | 3,77 | 0,2035 | 0,0188 | 3,79 | 0,2035 | 0,0296 |
| A02- | St. Andrä | Griffen | 1,77 | 0,1236 | 0,0063 | 1,78 | 0,1236 | 0,0099 | 2,49 | 0,1731 | 0,0145 | 2,50 | 0,1731 | 0,0228 | 3,67 | 0,1978 | 0,0183 | 3,68 | 0,1978 | 0,0288 |
| A02- | Griffen | Völkermarkt Ost | 0,90 | 0,0625 | 0,0032 | 0,90 | 0,0625 | 0,0050 | 1,26 | 0,0874 | 0,0073 | 1,26 | 0,0874 | 0,0115 | 1,85 | 0,0999 | 0,0093 | 1,86 | 0,0999 | 0,0145 |
| A02- | Völkermarkt Ost | Völkermarkt West | 2,07 | 0,1441 | 0,0074 | 2,07 | 0,1441 | 0,0116 | 2,90 | 0,2018 | 0,0169 | 2,91 | 0,2018 | 0,0266 | 4,28 | 0,2306 | 0,0214 | 4,29 | 0,2306 | 0,0336 |
| A02- | Völkermarkt West | Grafenstein | 1,98 | 0,1380 | 0,0070 | 1,98 | 0,1380 | 0,0111 | 2,78 | 0,1932 | 0,0162 | 2,79 | 0,1932 | 0,0255 | 4,09 | 0,2208 | 0,0204 | 4,11 | 0,2208 | 0,0321 |
| A02- | Grafenstein | Klagenfurt Ost | 1,27 | 0,0885 | 0,0045 | 1,27 | 0,0885 | 0,0071 | 1,78 | 0,1239 | 0,0104 | 1,79 | 0,1239 | 0,0163 | 2,63 | 0,1416 | 0,0131 | 2,63 | 0,1416 | 0,0206 |
| A02- | Klagenfurt Ost | Klagenfurt Flughafen | 0,64 | 0,0448 | 0,0023 | 0,64 | 0,0448 | 0,0036 | 0,90 | 0,0627 | 0,0053 | 0,90 | 0,0627 | 0,0083 | 1,33 | 0,0716 | 0,0066 | 1,33 | 0,0716 | 0,0104 |
| A02- | Klagenfurt Flughafen | Klagenfurt Nord | 0,71 | 0,0496 | 0,0025 | 0,71 | 0,0496 | 0,0040 | 1,00 | 0,0694 | 0,0058 | 1,00 | 0,0694 | 0,0092 | 1,47 | 0,0794 | 0,0073 | 1,48 | 0,0794 | 0,0115 |
| A02- | Klagenfurt Nord | Klagenfurt West | 1,23 | 0,0857 | 0,0044 | 1,23 | 0,0857 | 0,0069 | 1,73 | 0,1200 | 0,0101 | 1,73 | 0,1200 | 0,0158 | 2,54 | 0,1372 | 0,0127 | 2,55 | 0,1372 | 0,0200 |
| A02- | Klagenfurt West | Krumpendorf West | 0,49 | 0,0342 | 0,0017 | 0,49 | 0,0342 | 0,0027 | 0,69 | 0,0479 | 0,0040 | 0,69 | 0,0479 | 0,0063 | 1,01 | 0,0547 | 0,0051 | 1,02 | 0,0547 | 0,0080 |
| A02- | Krumpendorf West | Pörschach Ost | 0,59 | 0,0412 | 0,0021 | 0,59 | 0,0412 | 0,0033 | 0,83 | 0,0576 | 0,0048 | 0,83 | 0,0576 | 0,0076 | 1,22 | 0,0659 | 0,0061 | 1,23 | 0,0659 | 0,0096 |
| A02- | Pörschach Ost | Pörschach West | 0,92 | 0,0641 | 0,0033 | 0,92 | 0,0641 | 0,0051 | 1,29 | 0,0897 | 0,0075 | 1,30 | 0,0897 | 0,0118 | 1,90 | 0,1026 | 0,0095 | 1,91 | 0,1026 | 0,0149 |
| A02- | Pörschach West | Velden Ost | 0,68 | 0,0475 | 0,0024 | 0,68 | 0,0475 | 0,0038 | 0,96 | 0,0665 | 0,0056 | 0,96 | 0,0665 | 0,0088 | 1,41 | 0,0760 | 0,0070 | 1,41 | 0,0760 | 0,0111 |
| A02- | Velden Ost | Velden West | 0,73 | 0,0511 | 0,0026 | 0,74 | 0,0511 | 0,0041 | 1,03 | 0,0716 | 0,0060 | 1,03 | 0,0716 | 0,0094 | 1,52 | 0,0818 | 0,0076 | 1,52 | 0,0818 | 0,0119 |
| A02- | Velden West | Wernberg | 1,21 | 0,0845 | 0,0043 | 1,22 | 0,0845 | 0,0068 | 1,70 | 0,1183 | 0,0099 | 1,71 | 0,1183 | 0,0156 | 2,51 | 0,1352 | 0,0125 | 2,52 | 0,1352 | 0,0197 |
| A02- | Wernberg | KN Villach | 0,64 | 0,0449 | 0,0023 | 0,65 | 0,0449 | 0,0036 | 0,90 | 0,0629 | 0,0053 | 0,91 | 0,0629 | 0,0083 | 1,33 | 0,0719 | 0,0067 | 1,34 | 0,0719 | 0,0105 |
| A02- | KN Villach | Villach Faaker See | 0,50 | 0,0349 | 0,0018 | 0,50 | 0,0349 | 0,0028 | 0,70 | 0,0489 | 0,0041 | 0,71 | 0,0489 | 0,0065 | 1,04 | 0,0559 | 0,0052 | 1,04 | 0,0559 | 0,0081 |
| A02- | Villach Faaker See | Villach Warmbad | 1,15 | 0,0798 | 0,0041 | 1,15 | 0,0798 | 0,0064 | 1,61 | 0,1117 | 0,0094 | 1,61 | 0,1117 | 0,0147 | 2,37 | 0,1277 | 0,0118 | 2,38 | 0,1277 | 0,0186 |
| A02- | Villach Warmbad | Hermagor | 2,08 | 0,1447 | 0,0074 | 2,08 | 0,1447 | 0,0116 | 2,91 | 0,2025 | 0,0170 | 2,92 | 0,2025 | 0,0267 | 4,29 | 0,2315 | 0,0214 | 4,31 | 0,2315 | 0,0337 |
| A02- | Hermagor | Arnoldstein | 0,49 | 0,0345 | 0,0018 | 0,50 | 0,0345 | 0,0028 | 0,69 | 0,0482 | 0,0040 | 0,70 | 0,0482 | 0,0064 | 1,02 | 0,0551 | 0,0051 | 1,03 | 0,0551 | 0,0080 |
| A02- | Arnoldstein | Staatsgrenze Arnoldstein | 0,76 | 0,0528 | 0,0027 | 0,76 | 0,0528 | 0,0042 | 1,06 | 0,0740 | 0,0062 | 1,07 | 0,0740 | 0,0098 | 1,57 | 0,0845 | 0,0078 | 1,57 | 0,0845 | 0,0123 |
| | | | | | | | | | | | | | | | | | | | | |
| A03- | KN Guntramsdorf | Münchendorf/Achau | 0,20 | 0,0137 | 0,0007 | 0,20 | 0,0137 | 0,0011 | 0,28 | 0,0192 | 0,0016 | 0,28 | 0,0192 | 0,0025 | 0,41 | 0,0219 | 0,0020 | 0,41 | 0,0219 | 0,0032 |
| A03- | Münchendorf/Achau | Ebreichsdorf Nord | 0,83 | 0,0577 | 0,0029 | 0,83 | 0,0577 | 0,0046 | 1,16 | 0,0808 | 0,0068 | 1,17 | 0,0808 | 0,0107 | 1,71 | 0,0924 | 0,0086 | 1,72 | 0,0924 | 0,0134 |
| A03- | Ebreichsdorf Nord | Ebreichsdorf West | 0,68 | 0,0471 | 0,0024 | 0,68 | 0,0471 | 0,0038 | 0,95 | 0,0660 | 0,0055 | 0,95 | 0,0660 | 0,0087 | 1,40 | 0,0754 | 0,0070 | 1,40 | 0,0754 | 0,0110 |
| A03- | Ebreichsdorf West | Pottendorf | 0,89 | 0,0618 | 0,0032 | 0,89 | 0,0618 | 0,0050 | 1,25 | 0,0866 | 0,0073 | 1,25 | 0,0866 | 0,0114 | 1,83 | 0,0989 | 0,0092 | 1,84 | 0,0989 | 0,0144 |
| A03- | Pottendorf | Hornstein | 1,46 | 0,1015 | 0,0052 | 1,46 | 0,1015 | 0,0082 | 2,04 | 0,1421 | 0,0119 | 2,05 | 0,1421 | 0,0187 | 3,01 | 0,1624 | 0,0150 | 3,02 | 0,1624 | 0,0236 |
| A03- | Hornstein | Müllendorf | 0,95 | 0,0665 | 0,0034 | 0,96 | 0,0665 | 0,0053 | 1,34 | 0,0931 | 0,0078 | 1,34 | 0,0931 | 0,0123 | 1,97 | 0,1064 | 0,0099 | 1,98 | 0,1064 | 0,0155 |
| A03- | Müllendorf | KN Eisenstadt | 0,80 | 0,0556 | 0,0028 | 0,80 | 0,0556 | 0,0045 | 1,12 | 0,0779 | 0,0065 | 1,12 | 0,0779 | 0,0103 | 1,65 | 0,0890 | 0,0082 | 1,66 | 0,0890 | 0,0129 |
| A031 | KN Eisenstadt | Siegersdorf | 0,63 | 0,0438 | 0,0022 | 0,63 | 0,0438 | 0,0035 | 0,88 | 0,0614 | 0,0052 | 0,89 | 0,0614 | 0,0081 | 1,30 | 0,0701 | 0,0065 | 1,30 | 0,0701 | 0,0102 |
| | | | | | | | | | | | | | | | | | | | | |
| A041 | Stadionbrücke | KN Wien Prater | 0,12 | 0,0081 | 0,0004 | 0,12 | 0,0081 | 0,0006 | 0,16 | 0,0113 | 0,0009 | 0,16 | 0,0113 | 0,0015 | 0,24 | 0,0129 | 0,0012 | 0,24 | 0,0129 | 0,0019 |
| A04- | KN Wien Prater | Alt-Simmering | 0,25 | 0,0175 | 0,0009 | 0,25 | 0,0175 | 0,0014 | 0,35 | 0,0246 | 0,0021 | 0,35 | 0,0246 | 0,0032 | 0,52 | 0,0281 | 0,0026 | 0,52 | 0,0281 | 0,0041 |
| A04- | Alt-Simmering | Wien 7. Haidequerstraße | 0,19 | 0,0132 | 0,0007 | 0,19 | 0,0132 | 0,0011 | 0,27 | 0,0185 | 0,0016 | 0,27 | 0,0185 | 0,0024 | 0,39 | 0,0212 | 0,0020 | 0,39 | 0,0212 | 0,0031 |
| A04- | Wien 7. Haidequerstraße | Wien Simmeringer Haide | 0,36 | 0,0248 | 0,0013 | 0,36 | 0,0248 | 0,0020 | 0,50 | 0,0347 | 0,0029 | 0,50 | 0,0347 | 0,0046 | 0,73 | 0,0396 | 0,0037 | 0,74 | 0,0396 | 0,0058 |
| A04- | Wien Simmeringer Haide | KN Schwechat | 0,72 | 0,0499 | 0,0025 | 0,72 | 0,0499 | 0,0040 | 1,00 | 0,0698 | 0,0059 | 1,01 | 0,0698 | 0,0092 | 1,48 | 0,0798 | 0,0074 | 1,48 | 0,0798 | 0,0116 |
| A04- | KN Schwechat | Flughafen Wien Schwechat | 1,03 | 0,0720 | 0,0037 | 1,04 | 0,0720 | 0,0058 | 1,45 | 0,1008 | 0,0085 | 1,46 | 0,1008 | 0,0133 | 2,14 | 0,1153 | 0,0107 | 2,14 | 0,1153 | 0,0168 |
| A04- | Flughafen Wien Schwechat | Fischamend | 1,16 | 0,0807 | 0,0041 | 1,16 | 0,0807 | 0,0065 | 1,62 | 0,1129 | 0,0095 | 1,63 | 0,1129 | 0,0149 | 2,39 | 0,1290 | 0,0120 | 2,40 | 0,1290 | 0,0188 |
| A04- | Fischamend | Bruck/Leitha West | 2,54 | 0,1769 | 0,0090 | 2,54 | 0,1769 | 0,0142 | 3,56 | 0,2476 | 0,0208 | 3,57 | 0,2476 | 0,0327 | 5,25 | 0,28 | | | | |

| | | | | | | | | | | | | | | | | | | | | |
|------|------------------------|------------------------|-------|--------|--------|-------|--------|--------|-------|--------|--------|-------|--------|--------|-------|--------|--------|-------|--------|--------|
| A05- | Großkrut | Poysdorf Nord | 1,35 | 0,0939 | 0,0048 | 1,35 | 0,0939 | 0,0075 | 1,89 | 0,1314 | 0,0110 | 1,90 | 0,1314 | 0,0173 | 2,79 | 0,1502 | 0,0139 | 2,79 | 0,1502 | 0,0219 |
| A06- | KN Bruckneudorf | Potzneusiedl | 1,71 | 0,1189 | 0,0061 | 1,71 | 0,1189 | 0,0095 | 2,39 | 0,1665 | 0,0140 | 2,40 | 0,1665 | 0,0220 | 3,53 | 0,1903 | 0,0176 | 3,54 | 0,1903 | 0,0277 |
| A06- | Potzneusiedl | Gattendorf | 0,74 | 0,0516 | 0,0026 | 0,74 | 0,0516 | 0,0041 | 1,04 | 0,0723 | 0,0061 | 1,04 | 0,0723 | 0,0095 | 1,53 | 0,0826 | 0,0076 | 1,54 | 0,0826 | 0,0120 |
| A06- | Gattendorf | Kittsee | 1,24 | 0,0863 | 0,0044 | 1,24 | 0,0863 | 0,0069 | 1,74 | 0,1209 | 0,0101 | 1,74 | 0,1209 | 0,0159 | 2,56 | 0,1381 | 0,0128 | 2,57 | 0,1381 | 0,0201 |
| A06- | Kittsee | Staatsgrenze Kittsee | 0,63 | 0,0439 | 0,0022 | 0,63 | 0,0439 | 0,0035 | 0,88 | 0,0614 | 0,0052 | 0,89 | 0,0614 | 0,0081 | 1,30 | 0,0702 | 0,0065 | 1,31 | 0,0702 | 0,0102 |
| A07- | KN Linz | Linz Franzosenhausweg | 0,44 | 0,0309 | 0,0016 | 0,44 | 0,0309 | 0,0025 | 0,62 | 0,0433 | 0,0036 | 0,63 | 0,0433 | 0,0057 | 0,92 | 0,0495 | 0,0046 | 0,92 | 0,0495 | 0,0072 |
| A07- | Linz Franzosenhausweg | Linz Salzburger Straße | 0,39 | 0,0270 | 0,0014 | 0,39 | 0,0270 | 0,0022 | 0,54 | 0,0378 | 0,0032 | 0,55 | 0,0378 | 0,0050 | 0,80 | 0,0432 | 0,0040 | 0,80 | 0,0432 | 0,0063 |
| A07- | Linz Salzburger Straße | Neue Welt | 0,27 | 0,0187 | 0,0010 | 0,27 | 0,0187 | 0,0015 | 0,38 | 0,0262 | 0,0022 | 0,38 | 0,0262 | 0,0035 | 0,56 | 0,0300 | 0,0028 | 0,56 | 0,0300 | 0,0044 |
| A07- | Neue Welt | Muldenstraße | 0,13 | 0,0091 | 0,0005 | 0,13 | 0,0091 | 0,0007 | 0,18 | 0,0127 | 0,0011 | 0,18 | 0,0127 | 0,0017 | 0,27 | 0,0146 | 0,0013 | 0,27 | 0,0146 | 0,0021 |
| A07- | Muldenstraße | Bindermichl | 0,18 | 0,0128 | 0,0007 | 0,18 | 0,0128 | 0,0010 | 0,26 | 0,0179 | 0,0015 | 0,26 | 0,0179 | 0,0024 | 0,38 | 0,0205 | 0,0019 | 0,38 | 0,0205 | 0,0030 |
| A07- | Bindermichl | Leonding Linz Zentrum | 0,17 | 0,0119 | 0,0006 | 0,17 | 0,0119 | 0,0010 | 0,24 | 0,0166 | 0,0014 | 0,24 | 0,0166 | 0,0022 | 0,35 | 0,0190 | 0,0018 | 0,35 | 0,0190 | 0,0028 |
| A07- | Leonding Linz Zentrum | Linz Wiener Straße | 0,13 | 0,0093 | 0,0005 | 0,13 | 0,0093 | 0,0007 | 0,19 | 0,0131 | 0,0011 | 0,19 | 0,0131 | 0,0017 | 0,28 | 0,0149 | 0,0014 | 0,28 | 0,0149 | 0,0022 |
| A07- | Linz Wiener Straße | Linz VOEST | 0,21 | 0,0148 | 0,0008 | 0,21 | 0,0148 | 0,0012 | 0,30 | 0,0207 | 0,0017 | 0,30 | 0,0207 | 0,0027 | 0,44 | 0,0237 | 0,0022 | 0,44 | 0,0237 | 0,0034 |
| A07- | Linz VOEST | Linz Industriezeile | 0,40 | 0,0277 | 0,0014 | 0,40 | 0,0277 | 0,0022 | 0,56 | 0,0388 | 0,0033 | 0,56 | 0,0388 | 0,0051 | 0,82 | 0,0443 | 0,0041 | 0,82 | 0,0443 | 0,0065 |
| A07- | Linz Industriezeile | Linz Prinz Eugenstraße | 0,16 | 0,0109 | 0,0006 | 0,16 | 0,0109 | 0,0009 | 0,22 | 0,0152 | 0,0013 | 0,22 | 0,0152 | 0,0020 | 0,32 | 0,0174 | 0,0016 | 0,32 | 0,0174 | 0,0025 |
| A07- | Linz Prinz Eugenstraße | Linz Hafenstraße | 0,38 | 0,0264 | 0,0013 | 0,38 | 0,0264 | 0,0021 | 0,53 | 0,0369 | 0,0031 | 0,53 | 0,0369 | 0,0049 | 0,78 | 0,0422 | 0,0039 | 0,78 | 0,0422 | 0,0061 |
| A07- | Linz Hafenstraße | Linz Urfahr | 0,83 | 0,0580 | 0,0030 | 0,83 | 0,0580 | 0,0047 | 1,17 | 0,0812 | 0,0068 | 1,17 | 0,0812 | 0,0107 | 1,72 | 0,0928 | 0,0086 | 1,73 | 0,0928 | 0,0135 |
| A07- | Linz Urfahr | Treffling | 0,63 | 0,0437 | 0,0022 | 0,63 | 0,0437 | 0,0035 | 0,88 | 0,0612 | 0,0051 | 0,88 | 0,0612 | 0,0081 | 1,30 | 0,0699 | 0,0065 | 1,30 | 0,0699 | 0,0102 |
| A07- | Treffling | Gallneukirchen | 0,56 | 0,0389 | 0,0020 | 0,56 | 0,0389 | 0,0031 | 0,78 | 0,0545 | 0,0046 | 0,79 | 0,0545 | 0,0072 | 1,16 | 0,0623 | 0,0058 | 1,16 | 0,0623 | 0,0091 |
| A07- | Gallneukirchen | Engerwitzdorf | 0,72 | 0,0499 | 0,0026 | 0,72 | 0,0499 | 0,0040 | 1,01 | 0,0699 | 0,0059 | 1,01 | 0,0699 | 0,0092 | 1,48 | 0,0799 | 0,0074 | 1,49 | 0,0799 | 0,0116 |
| A07- | Engerwitzdorf | Unterweikersdorf | | | | | | | | | | | | | | | | | | |
| A08- | KN Voralpenkreuz | Wels West | 2,20 | 0,1531 | 0,0078 | 2,20 | 0,1531 | 0,0123 | 3,08 | 0,2144 | 0,0180 | 3,09 | 0,2144 | 0,0283 | 4,54 | 0,2450 | 0,0227 | 4,56 | 0,2450 | 0,0357 |
| A08- | Wels West | KN Wels | 0,78 | 0,0540 | 0,0028 | 0,78 | 0,0540 | 0,0043 | 1,09 | 0,0756 | 0,0063 | 1,09 | 0,0756 | 0,0100 | 1,60 | 0,0864 | 0,0080 | 1,61 | 0,0864 | 0,0126 |
| A08- | KN Wels | Pichl/Bad Schallerbach | 0,85 | 0,0594 | 0,0030 | 0,85 | 0,0594 | 0,0048 | 1,20 | 0,0832 | 0,0070 | 1,20 | 0,0832 | 0,0110 | 1,76 | 0,0951 | 0,0088 | 1,77 | 0,0951 | 0,0138 |
| A08- | Pichl/Bad Schallerbach | Meggenhofen | 2,16 | 0,1502 | 0,0077 | 2,16 | 0,1502 | 0,0121 | 3,02 | 0,2102 | 0,0176 | 3,03 | 0,2102 | 0,0277 | 4,46 | 0,2403 | 0,0223 | 4,47 | 0,2403 | 0,0350 |
| A08- | Meggenhofen | Gallspach | 2,35 | 0,1637 | 0,0084 | 2,35 | 0,1637 | 0,0131 | 3,30 | 0,2291 | 0,0192 | 3,31 | 0,2291 | 0,0302 | 4,86 | 0,2619 | 0,0243 | 4,87 | 0,2619 | 0,0381 |
| A08- | Gallspach | Haag am Hausruck | 2,14 | 0,1494 | 0,0076 | 2,15 | 0,1494 | 0,0120 | 3,01 | 0,2091 | 0,0176 | 3,02 | 0,2091 | 0,0276 | 4,43 | 0,2390 | 0,0221 | 4,45 | 0,2390 | 0,0348 |
| A08- | Haag am Hausruck | Ried im Innkreis | 2,30 | 0,1603 | 0,0082 | 2,31 | 0,1603 | 0,0129 | 3,23 | 0,2244 | 0,0188 | 3,24 | 0,2244 | 0,0296 | 4,76 | 0,2565 | 0,0238 | 4,77 | 0,2565 | 0,0373 |
| A08- | Ried im Innkreis | Ort im Innkreis | 1,74 | 0,1210 | 0,0062 | 1,74 | 0,1210 | 0,0097 | 2,44 | 0,1694 | 0,0142 | 2,44 | 0,1694 | 0,0223 | 3,59 | 0,1936 | 0,0179 | 3,60 | 0,1936 | 0,0282 |
| A08- | Ort im Innkreis | Schärding Suben | 0,44 | 0,0306 | 0,0016 | 0,44 | 0,0306 | 0,0025 | 0,62 | 0,0428 | 0,0036 | 0,62 | 0,0428 | 0,0056 | 0,91 | 0,0489 | 0,0045 | 0,91 | 0,0489 | 0,0071 |
| A08- | Schärding Suben | Staatsgrenze Suben | | | | | | | | | | | | | | | | | | |
| A09- | KN Voralpenkreuz | Ried im Traunkreis | 1,08 | 0,0754 | 0,0039 | 1,08 | 0,0754 | 0,0061 | 1,52 | 0,1055 | 0,0089 | 1,52 | 0,1055 | 0,0139 | 2,24 | 0,1206 | 0,0112 | 2,24 | 0,1206 | 0,0175 |
| A09- | Ried im Traunkreis | Inzersdorf Kirchdorf | 2,03 | 0,1414 | 0,0072 | 2,03 | 0,1414 | 0,0114 | 2,85 | 0,1979 | 0,0166 | 2,86 | 0,1979 | 0,0261 | 4,20 | 0,2262 | 0,0209 | 4,21 | 0,2262 | 0,0329 |
| A09- | Inzersdorf Kirchdorf | Klaus | 2,47 | 0,1722 | 0,0088 | 2,48 | 0,1722 | 0,0138 | 3,47 | 0,2411 | 0,0202 | 3,48 | 0,2411 | 0,0318 | 5,11 | 0,2755 | 0,0255 | 5,13 | 0,2755 | 0,0401 |
| A09- | Klaus | St. Pankratz | 1,57 | 0,1095 | 0,0056 | 1,57 | 0,1095 | 0,0088 | 2,20 | 0,1532 | 0,0129 | 2,21 | 0,1532 | 0,0202 | 3,25 | 0,1751 | 0,0162 | 3,26 | 0,1751 | 0,0255 |
| A09- | St. Pankratz | Roßleiten | 2,19 | 0,1527 | 0,0078 | 2,20 | 0,1527 | 0,0123 | 3,08 | 0,2138 | 0,0179 | 3,09 | 0,2138 | 0,0282 | 4,53 | 0,2444 | 0,0226 | 4,55 | 0,2444 | 0,0356 |
| A09- | Roßleiten | Windischgarsten | 1,03 | 0,0718 | 0,0037 | 1,03 | 0,0718 | 0,0058 | 1,45 | 0,1005 | 0,0084 | 1,45 | 0,1005 | 0,0133 | 2,13 | 0,1149 | 0,0106 | 2,14 | 0,1149 | 0,0167 |
| A09- | Windischgarsten | Gleinkerau | 0,78 | 0,0541 | 0,0028 | 0,78 | 0,0541 | 0,0043 | 1,09 | 0,0758 | 0,0064 | 1,09 | 0,0758 | 0,0100 | 1,61 | 0,0866 | 0,0080 | 1,61 | 0,0866 | 0,0126 |
| A09- | Gleinkerau | Spital am Pyhrn | 4,27 | 0,1378 | 0,0070 | 4,27 | 0,1378 | 0,0113 | 5,98 | 0,1929 | 0,0162 | 5,99 | 0,1929 | 0,0254 | 8,90 | 0,2204 | 0,0204 | 8,91 | 0,2204 | 0,0321 |
| A09- | Spital am Pyhrn | Ardning / Admont | 0,45 | 0,0314 | 0,0016 | 0,45 | 0,0314 | 0,0025 | 0,63 | 0,0440 | 0,0037 | 0,63 | 0,0440 | 0,0058 | 0,93 | 0,0502 | 0,0047 | 0,93 | 0,0502 | 0,0073 |
| A09- | Ardning / Admont | Liezen | 0,94 | 0,0656 | 0,0034 | 0,94 | 0,0656 | 0,0053 | 1,32 | 0,0919 | 0,0077 | 1,33 | 0,0919 | 0,0121 | 1,95 | 0,1050 | 0,0097 | 1,95 | 0,1050 | 0,0153 |
| A09- | Liezen | Rottenmann | 2,35 | 0,1636 | 0,0084 | 2,35 | 0,1636 | 0,0131 | 3,29 | 0,2290 | 0,0192 | 3,30 | 0,2290 | 0,0302 | 4,85 | 0,2617 | 0,0242 | 4,87 | 0,2617 | 0,0381 |
| A09- | Rottenmann | Trieben | 1,91 | 0,1330 | 0,0068 | 1,91 | 0,1330 | 0,0107 | 2,68 | 0,1862 | 0,0156 | 2,69 | 0,1862 | 0,0246 | 3,95 | 0,2128 | 0,0197 | 3,96 | 0,2128 | 0,0310 |
| A09- | Trieben | Treglwang | 2,56 | 0,1787 | 0,0091 | 2,57 | 0,1787 | 0,0143 | 3,60 | 0,2502 | 0,0210 | 3,61 | 0,2502 | 0,0330 | 5,30 | 0,2859 | 0,0265 | 5,32 | 0,2859 | 0,0416 |
| A09- | Treglwang | Kalwang | 1,19 | 0,0832 | 0,0043 | 1,20 | 0,0832 | 0,0067 | 1,68 | 0,1165 | 0,0098 | 1,68 | 0,1165 | 0,0154 | 2,47 | 0,1331 | 0,0123 | 2,48 | 0,1331 | 0,0194 |
| A09- | Kalwang | Mautern | 1,34 | 0,0936 | 0,0048 | 1,35 | 0,0936 | 0,0075 | 1,89 | 0,1311 | 0,0110 | 1,89 | 0,1311 | 0,0173 | 2,78 | 0,1498 | 0,0139 | 2,79 | 0,1498 | 0,0218 |
| A09- | Mautern | Kammern | 1,40 | 0,0979 | 0,0050 | 1,41 | 0,0979 | 0,0079 | 1,97 | 0,1370 | 0,0115 | 1,98 | 0,1370 | 0,0181 | 2,90 | 0,1566 | 0,0145 | 2,91 | 0,1566 | 0,0228 |
| A09- | Kammern | Traboch | 0,28 | 0,0192 | 0,0010 | 0,28 | 0,0192 | 0,0015 | 0,39 | 0,0269 | 0,0023 | 0,39 | 0,0269 | 0,0035 | 0,57 | 0,0308 | 0,0028 | 0,57 | 0,0308 | 0,0045 |
| A09- | Traboch | Terminal St. Michael | 0,52 | 0,0360 | 0,0018 | 0,52 | 0,0360 | 0,0029 | 0,73 | 0,0504 | 0,0042 | 0,73 | 0,0504 | 0,0067 | 1,07 | 0,0576 | 0,0053 | 1,07 | 0,0576 | 0,0084 |
| A09- | Terminal St. Michael | KN St. Michael | 10,40 | 0,3356 | 0,0171 | 10,41 | 0,3356 | 0,0269 | 14,58 | 0,4698 | 0,0394 | 14,60 | 0,4698 | 0,0620 | 21,69 | 0,5369 | 0,0497 | 21,71 | 0,5369 | 0,0781 |
| A09- | KN St. Michael | Übelbach | 1,59 | 0,1110 | 0,0057 | 1,60 | 0,1110 | 0,0089 | 2,23 | 0,1554 | 0,0130 | 2,24 | 0,1554 | 0,0205 | 3,29 | 0,1776 | 0,0164 | 3,30 | 0,1776 | 0,0258 |
| A09- | Übelbach | KN Peggau | 0,75 | 0,0526 | 0,0027 | 0,76 | 0,0526 | 0,0042 | 1,06 | 0,0736 | 0,0062 | 1,06 | 0,0736 | 0,0097 | 1,56 | 0,0841 | 0,0078 | 1,56 | 0,0841 | 0,0122 |
| A09- | KN P | | | | | | | | | | | | | | | | | | | |

| | | | | | | | | | | | | | | | | | | | | |
|------|--|---|-------|--------|--------|-------|--------|--------|-------|--------|--------|-------|--------|--------|-------|--------|--------|-------|--------|--------|
| A10- | Hallein | Kuchl | 1,15 | 0,0802 | 0,0041 | 1,15 | 0,0802 | 0,0064 | 1,61 | 0,1123 | 0,0094 | 1,62 | 0,1123 | 0,0148 | 2,38 | 0,1283 | 0,0119 | 2,39 | 0,1283 | 0,0187 |
| A10- | Kuchl | Golling / Abtenau | 1,16 | 0,0806 | 0,0041 | 1,16 | 0,0806 | 0,0065 | 1,62 | 0,1129 | 0,0095 | 1,63 | 0,1129 | 0,0149 | 2,39 | 0,1290 | 0,0119 | 2,40 | 0,1290 | 0,0188 |
| A10- | Golling / Abtenau | Paß Lueg | 1,21 | 0,0841 | 0,0043 | 1,21 | 0,0841 | 0,0068 | 1,69 | 0,1178 | 0,0099 | 1,70 | 0,1178 | 0,0155 | 2,50 | 0,1346 | 0,0125 | 2,50 | 0,1346 | 0,0196 |
| A10- | Paß Lueg | Werfen | 1,72 | 0,1198 | 0,0061 | 1,72 | 0,1198 | 0,0096 | 2,41 | 0,1678 | 0,0141 | 2,42 | 0,1678 | 0,0221 | 3,56 | 0,1917 | 0,0178 | 3,57 | 0,1917 | 0,0279 |
| A10- | Werfen | Pfarrwerfen / Werfen | 0,22 | 0,0156 | 0,0008 | 0,22 | 0,0156 | 0,0013 | 0,31 | 0,0219 | 0,0018 | 0,32 | 0,0219 | 0,0029 | 0,46 | 0,0250 | 0,0023 | 0,46 | 0,0250 | 0,0036 |
| A10- | Pfarrwerfen / Werfen | KN Pongau | 0,49 | 0,0339 | 0,0017 | 0,49 | 0,0339 | 0,0027 | 0,68 | 0,0475 | 0,0040 | 0,68 | 0,0475 | 0,0063 | 1,01 | 0,0542 | 0,0050 | 1,01 | 0,0542 | 0,0079 |
| A101 | KN Pongau | Bischofshofen Mühlbach a. Hochkönig | 0,72 | 0,0504 | 0,0026 | 0,72 | 0,0504 | 0,0040 | 1,02 | 0,0706 | 0,0059 | 1,02 | 0,0706 | 0,0093 | 1,50 | 0,0807 | 0,0075 | 1,50 | 0,0807 | 0,0117 |
| A10- | KN Pongau | Lammertal Hütttau | 1,98 | 0,1379 | 0,0070 | 1,98 | 0,1379 | 0,0111 | 2,78 | 0,1930 | 0,0162 | 2,79 | 0,1930 | 0,0255 | 4,09 | 0,2206 | 0,0204 | 4,10 | 0,2206 | 0,0321 |
| A10- | Lammertal Hütttau | F. Verbindung GH Eben | 0,51 | 0,0355 | 0,0018 | 0,51 | 0,0355 | 0,0028 | 0,71 | 0,0497 | 0,0042 | 0,72 | 0,0497 | 0,0066 | 1,05 | 0,0568 | 0,0053 | 1,06 | 0,0568 | 0,0083 |
| A10- | F. Verbindung GH Eben | Eben | 0,24 | 0,0164 | 0,0008 | 0,24 | 0,0164 | 0,0013 | 0,33 | 0,0230 | 0,0019 | 0,33 | 0,0230 | 0,0030 | 0,49 | 0,0263 | 0,0024 | 0,49 | 0,0263 | 0,0038 |
| A10- | Eben | Radstadt Altenmarkt Graz | 0,52 | 0,0365 | 0,0019 | 0,53 | 0,0365 | 0,0029 | 0,74 | 0,0511 | 0,0043 | 0,74 | 0,0511 | 0,0067 | 1,08 | 0,0584 | 0,0054 | 1,09 | 0,0584 | 0,0085 |
| A10- | Radstadt Altenmarkt Graz | Flachau | 0,73 | 0,0511 | 0,0026 | 0,73 | 0,0511 | 0,0041 | 1,03 | 0,0715 | 0,0060 | 1,03 | 0,0715 | 0,0094 | 1,52 | 0,0817 | 0,0076 | 1,52 | 0,0817 | 0,0119 |
| A10- | Flachau | Flachauwinkel | 2,86 | 0,0996 | 0,0051 | 2,86 | 0,0996 | 0,0080 | 4,01 | 0,1394 | 0,0117 | 4,01 | 0,1394 | 0,0184 | 5,96 | 0,1594 | 0,0148 | 5,97 | 0,1594 | 0,0232 |
| A10- | Flachauwinkel | Zederhaus | 7,20 | 0,2510 | 0,0128 | 7,21 | 0,2510 | 0,0202 | 10,10 | 0,3514 | 0,0295 | 10,11 | 0,3514 | 0,0464 | 15,01 | 0,4016 | 0,0372 | 15,03 | 0,4016 | 0,0584 |
| A10- | Zederhaus | St. Michael/Lungau | 4,75 | 0,1656 | 0,0085 | 4,76 | 0,1656 | 0,0133 | 6,66 | 0,2318 | 0,0195 | 6,67 | 0,2318 | 0,0306 | 9,91 | 0,2650 | 0,0245 | 9,92 | 0,2650 | 0,0386 |
| A10- | St. Michael/Lungau | Rennweg Katschberg | 3,48 | 0,1214 | 0,0062 | 3,49 | 0,1214 | 0,0097 | 4,88 | 0,1700 | 0,0143 | 4,89 | 0,1700 | 0,0224 | 7,26 | 0,1943 | 0,0180 | 7,27 | 0,1943 | 0,0283 |
| A102 | Seeboden | KN Spittal Millstätter See | 0,38 | 0,0266 | 0,0014 | 0,38 | 0,0266 | 0,0021 | 0,54 | 0,0372 | 0,0031 | 0,54 | 0,0372 | 0,0049 | 0,79 | 0,0425 | 0,0039 | 0,79 | 0,0425 | 0,0062 |
| A102 | KN Spittal Millstätter See | Lendorf | 0,82 | 0,0573 | 0,0029 | 0,82 | 0,0573 | 0,0046 | 1,15 | 0,0803 | 0,0067 | 1,16 | 0,0803 | 0,0106 | 1,70 | 0,0917 | 0,0085 | 1,71 | 0,0917 | 0,0134 |
| A10- | Rennweg Katschberg | Gmünd Maltatal | 3,33 | 0,2320 | 0,0119 | 3,34 | 0,2320 | 0,0186 | 4,67 | 0,3248 | 0,0273 | 4,69 | 0,3248 | 0,0428 | 6,88 | 0,3712 | 0,0344 | 6,90 | 0,3712 | 0,0540 |
| A10- | Gmünd Maltatal | KN Spittal Millstätter See | 1,89 | 0,1320 | 0,0067 | 1,90 | 0,1320 | 0,0106 | 2,66 | 0,1849 | 0,0155 | 2,67 | 0,1849 | 0,0244 | 3,92 | 0,2113 | 0,0196 | 3,93 | 0,2113 | 0,0307 |
| A10- | KN Spittal Millstätter See | Spittal Ost | 1,44 | 0,1000 | 0,0051 | 1,44 | 0,1000 | 0,0080 | 2,01 | 0,1400 | 0,0118 | 2,02 | 0,1400 | 0,0185 | 2,97 | 0,1600 | 0,0148 | 2,98 | 0,1600 | 0,0233 |
| A10- | Spittal Ost | Paternion Feistritz | 2,48 | 0,1727 | 0,0088 | 2,48 | 0,1727 | 0,0139 | 3,48 | 0,2418 | 0,0203 | 3,49 | 0,2418 | 0,0319 | 5,13 | 0,2763 | 0,0256 | 5,14 | 0,2763 | 0,0402 |
| A10- | Paternion Feistritz | Villach West | 2,67 | 0,1862 | 0,0095 | 2,68 | 0,1862 | 0,0149 | 3,75 | 0,2606 | 0,0219 | 3,76 | 0,2606 | 0,0344 | 5,52 | 0,2978 | 0,0276 | 5,54 | 0,2978 | 0,0433 |
| A10- | Villach West | Villach Ossiacher See | 1,15 | 0,0805 | 0,0041 | 1,16 | 0,0805 | 0,0065 | 1,62 | 0,1127 | 0,0095 | 1,63 | 0,1127 | 0,0149 | 2,39 | 0,1288 | 0,0119 | 2,40 | 0,1288 | 0,0187 |
| A10- | Villach Ossiacher See | KN Villach | 0,90 | 0,0629 | 0,0032 | 0,90 | 0,0629 | 0,0050 | 1,27 | 0,0880 | 0,0074 | 1,27 | 0,0880 | 0,0116 | 1,87 | 0,1006 | 0,0093 | 1,87 | 0,1006 | 0,0146 |
| A11- | KN Villach | St. Niklas Faakersee | 0,65 | 0,0450 | 0,0023 | 0,65 | 0,0450 | 0,0036 | 0,91 | 0,0630 | 0,0053 | 0,91 | 0,0630 | 0,0083 | 1,34 | 0,0720 | 0,0067 | 1,34 | 0,0720 | 0,0105 |
| A11- | St. Niklas Faakersee | St. Jakob/Rosental | 1,62 | 0,1130 | 0,0058 | 1,63 | 0,1130 | 0,0091 | 2,28 | 0,1583 | 0,0133 | 2,28 | 0,1583 | 0,0209 | 3,35 | 0,1809 | 0,0167 | 3,36 | 0,1809 | 0,0263 |
| A11- | St. Jakob/Rosental | Staatsgrenze Karawankentunnel | 15,85 | 0,1330 | 0,0068 | 15,85 | 0,1330 | 0,0107 | 22,20 | 0,1862 | 0,0156 | 22,20 | 0,1862 | 0,0246 | 33,22 | 0,2128 | 0,0197 | 33,23 | 0,2128 | 0,0310 |
| A12- | Staatsgrenze Kufstein | Kufstein Nord | 0,36 | 0,0000 | 0,0000 | 0,36 | 0,0000 | 0,0000 | 0,51 | 0,0000 | 0,0000 | 0,51 | 0,0000 | 0,0000 | 0,76 | 0,0000 | 0,0000 | 0,76 | 0,0000 | 0,0000 |
| A12- | Kufstein Nord | Kufstein Süd | 0,93 | 0,0000 | 0,0000 | 0,93 | 0,0000 | 0,0000 | 1,31 | 0,0000 | 0,0000 | 1,31 | 0,0000 | 0,0000 | 1,96 | 0,0000 | 0,0000 | 1,96 | 0,0000 | 0,0000 |
| A12- | Kufstein Süd | Kirchbichl Langkampfen | 1,27 | 0,0000 | 0,0000 | 1,27 | 0,0000 | 0,0000 | 1,78 | 0,0000 | 0,0000 | 1,78 | 0,0000 | 0,0000 | 2,68 | 0,0000 | 0,0000 | 2,68 | 0,0000 | 0,0000 |
| A12- | Kirchbichl Langkampfen | Wörgl Ost St.Johann i. T. Brixental | 1,25 | 0,0000 | 0,0000 | 1,25 | 0,0000 | 0,0000 | 1,75 | 0,0000 | 0,0000 | 1,75 | 0,0000 | 0,0000 | 2,62 | 0,0000 | 0,0000 | 2,62 | 0,0000 | 0,0000 |
| A12- | Wörgl Ost St.Johann i. T. Brixental | Wörgl West | 0,66 | 0,0000 | 0,0000 | 0,66 | 0,0000 | 0,0000 | 0,92 | 0,0000 | 0,0000 | 0,92 | 0,0000 | 0,0000 | 1,38 | 0,0000 | 0,0000 | 1,38 | 0,0000 | 0,0000 |
| A12- | Wörgl West | Kramsach Rattenberg Brixlegg | 2,80 | 0,0000 | 0,0000 | 2,80 | 0,0000 | 0,0000 | 3,92 | 0,0000 | 0,0000 | 3,92 | 0,0000 | 0,0000 | 5,88 | 0,0000 | 0,0000 | 5,88 | 0,0000 | 0,0000 |
| A12- | Kramsach Rattenberg Brixlegg | Wiesing Achensee Zillertal | 1,72 | 0,0000 | 0,0000 | 1,72 | 0,0000 | 0,0000 | 2,40 | 0,0000 | 0,0000 | 2,40 | 0,0000 | 0,0000 | 3,61 | 0,0000 | 0,0000 | 3,61 | 0,0000 | 0,0000 |
| A12- | Wiesing Achensee Zillertal | Jenbach | 0,68 | 0,0000 | 0,0000 | 0,68 | 0,0000 | 0,0000 | 0,95 | 0,0000 | 0,0000 | 0,95 | 0,0000 | 0,0000 | 1,43 | 0,0000 | 0,0000 | 1,43 | 0,0000 | 0,0000 |
| A12- | Jenbach | Schwaz | 1,50 | 0,0000 | 0,0000 | 1,50 | 0,0000 | 0,0000 | 2,10 | 0,0000 | 0,0000 | 2,10 | 0,0000 | 0,0000 | 3,15 | 0,0000 | 0,0000 | 3,15 | 0,0000 | 0,0000 |
| A12- | Schwaz | Vomp | 0,86 | 0,0000 | 0,0000 | 0,86 | 0,0000 | 0,0000 | 1,20 | 0,0000 | 0,0000 | 1,20 | 0,0000 | 0,0000 | 1,80 | 0,0000 | 0,0000 | 1,80 | 0,0000 | 0,0000 |
| A12- | Vomp | Wattens | 1,77 | 0,0000 | 0,0000 | 1,77 | 0,0000 | 0,0000 | 2,47 | 0,0000 | 0,0000 | 2,47 | 0,0000 | 0,0000 | 3,71 | 0,0000 | 0,0000 | 3,71 | 0,0000 | 0,0000 |
| A12- | Wattens | Hall/Tirol Mitte | 1,57 | 0,0000 | 0,0000 | 1,57 | 0,0000 | 0,0000 | 2,19 | 0,0000 | 0,0000 | 2,19 | 0,0000 | 0,0000 | 3,29 | 0,0000 | 0,0000 | 3,29 | 0,0000 | 0,0000 |
| A12- | Hall/Tirol Mitte | Hall/Tirol West | 0,63 | 0,0000 | 0,0000 | 0,63 | 0,0000 | 0,0000 | 0,88 | 0,0000 | 0,0000 | 0,88 | 0,0000 | 0,0000 | 1,32 | 0,0000 | 0,0000 | 1,32 | 0,0000 | 0,0000 |
| A12- | Hall/Tirol West | A12 Innsbruck Ost | 0,70 | 0,0000 | 0,0000 | 0,70 | 0,0000 | 0,0000 | 0,97 | 0,0000 | 0,0000 | 0,97 | 0,0000 | 0,0000 | 1,46 | 0,0000 | 0,0000 | 1,46 | 0,0000 | 0,0000 |
| A12- | A12 Innsbruck Ost | Innsbruck Mitte | 0,46 | 0,0078 | 0,0004 | 0,46 | 0,0078 | 0,0006 | 0,65 | 0,0109 | 0,0009 | 0,65 | 0,0109 | 0,0014 | 0,97 | 0,0124 | 0,0011 | 0,97 | 0,0124 | 0,0018 |
| A12- | Innsbruck Mitte | A12 Innsbruck West | 0,63 | 0,0438 | 0,0022 | 0,63 | 0,0438 | 0,0035 | 0,88 | 0,0614 | 0,0052 | 0,89 | 0,0614 | 0,0081 | 1,30 | 0,0701 | 0,0065 | 1,30 | 0,0701 | 0,0102 |
| A12- | A12 Innsbruck West | Innsbruck Kranebitten | 0,82 | 0,0575 | 0,0029 | 0,83 | 0,0575 | 0,0046 | 1,16 | 0,0804 | 0,0068 | 1,16 | 0,0804 | 0,0106 | 1,71 | 0,0919 | 0,0085 | 1,71 | 0,0919 | 0,0134 |
| A12- | Innsbruck Kranebitten | Zirl Ost Garmisch Seefeld | 0,96 | 0,0667 | 0,0034 | 0,96 | 0,0667 | 0,0054 | 1,34 | 0,0933 | 0,0078 | 1,35 | 0,0933 | 0,0123 | 1,98 | 0,1067 | 0,0099 | 1,98 | 0,1067 | 0,0155 |
| A12- | Zirl Ost Garmisch Seefeld | Zirl West | 0,60 | 0,0417 | 0,0021 | 0,60 | 0,0417 | 0,0033 | 0,84 | 0,0584 | 0,0049 | 0,84 | 0,0584 | 0,0077 | 1,24 | 0,0667 | 0,0062 | 1,24 | 0,0667 | 0,0097 |
| A12- | Zirl West | Petttau | 1,07 | 0,0747 | 0,0038 | 1,07 | 0,0747 | 0,0060 | 1,50 | 0,1046 | 0,0088 | 1,51 | 0,1046 | 0,0138 | 2,22 | 0,1195 | 0,0111 | 2,22 | 0,1195 | 0,0174 |
| A12- | Petttau | Telfs Ost | 1,08 | 0,0755 | 0,0039 | 1,09 | 0,0755 | 0,0061 | 1,52 | 0,1057 | 0,0089 | 1,53 | 0,1057 | 0,0139 | 2,24 | 0,1208 | 0,0112 | 2,25 | 0,1208 | 0,0176 |
| A12- | Telfs Ost | Telfs West | 0,53 | 0,0369 | 0,0019 | 0,53 | 0,0369 | 0,0030 | 0,74 | 0,0516 | 0,0043 | 0,75 | 0,0516 | 0,0068 | 1,09 | 0,0590 | 0,0055 | 1,10 | 0,0590 | 0,0086 |
| A12- | Telfs West | Mötz Reutte | 1,71 | 0,1192 | 0,0061 | 1,71 | 0,1192 | 0,0096 | 2,40 | 0,1669 | 0,0140 | 2,41 | 0,1669 | 0,0220 | 3,54 | 0,1907 | 0,0177 | 3,55 | 0,1907 | 0,0278 |
| A12- | Mötz Reutte | Haiming Ötztal | 1,99 | 0,1386 | 0,0071 | 1,99 | 0,1386 | 0,0111 | 2,79 | 0,1941 | 0,0163 | 2,80 | 0,1941 | 0,0256 | 4,11 | 0,2218 | 0,0205 | 4,13 | 0,2218 | 0,0323 |
| A12- | Haiming Ötztal | Imst | 1,58 | 0,1104 | 0,0056 | 1,59 | 0,1104 | 0,0089 | 2,22 | 0,1545 | 0,0130 | 2,23 | 0,1545 | 0,0204 | 3,28 | 0,1766 | 0,0164 | 3,28 | 0,1766 | 0,0257 |
| A12- | Imst | Imst Au | 0,27 | 0,0187 | 0,0010 | 0,27 | 0,0187 | 0,0015 | 0,38 | 0,0262 | 0,0022 | 0,38 | 0,0262 | 0,0035 | 0,55 | 0,0299 | 0,0028 | 0,56 | 0,0299 | 0,0044 |
| A12- | Imst Au | Mils | 0,58 | 0,0401 | 0,0021 | 0,58 | 0,0401 | 0,0032 | 0,81 | 0,0562 | 0,0047 | 0,81 | 0,0562 | 0,0074 | 1,19 | 0,0642 | 0,0059 | 1,19 | 0,0642 | 0,0093 |
| A12- | Mils | Mils Schönwies | 0,93 | 0,0647 | 0,0033 | 0,93 | 0,0647 | 0,0052 | 1,30 | 0,0905 | 0,0076 | 1,31 | 0,0905 | 0,0119 | 1,92 | 0,1035 | 0,0096 | 1,92 | 0 | |

| | | | | | | | | | | | | | | | | | | | | |
|------|------------------------------------|------------------------------------|------|--------|--------|------|--------|--------|------|--------|--------|------|--------|--------|------|--------|--------|------|--------|--------|
| A14- | Staatsgrenze Hörbranz | Hörbranz Lochau | 0,25 | 0,0173 | 0,0009 | 0,25 | 0,0173 | 0,0014 | 0,35 | 0,0242 | 0,0020 | 0,35 | 0,0242 | 0,0032 | 0,51 | 0,0276 | 0,0026 | 0,51 | 0,0276 | 0,0040 |
| A14- | Hörbranz Lochau | KN Bregenz | 1,52 | 0,1062 | 0,0054 | 1,53 | 0,1062 | 0,0085 | 2,14 | 0,1486 | 0,0125 | 2,14 | 0,1486 | 0,0196 | 3,15 | 0,1699 | 0,0157 | 3,16 | 0,1699 | 0,0247 |
| A14- | KN Bregenz | Lauterach Wolfurt | 0,08 | 0,0053 | 0,0003 | 0,08 | 0,0053 | 0,0004 | 0,11 | 0,0075 | 0,0006 | 0,11 | 0,0075 | 0,0010 | 0,16 | 0,0085 | 0,0008 | 0,16 | 0,0085 | 0,0012 |
| A14- | Lauterach Wolfurt | Wolfurt Lauterach | 0,68 | 0,0472 | 0,0024 | 0,68 | 0,0472 | 0,0038 | 0,95 | 0,0661 | 0,0056 | 0,95 | 0,0661 | 0,0087 | 1,40 | 0,0756 | 0,0070 | 1,41 | 0,0756 | 0,0110 |
| A14- | Wolfurt Lauterach | Dornbirn Nord Bregenzerwald | 0,26 | 0,0183 | 0,0009 | 0,26 | 0,0183 | 0,0015 | 0,37 | 0,0256 | 0,0021 | 0,37 | 0,0256 | 0,0034 | 0,54 | 0,0292 | 0,0027 | 0,54 | 0,0292 | 0,0043 |
| A14- | Dornbirn Nord Bregenzerwald | Dornbirn Süd Lustenau | 0,73 | 0,0511 | 0,0026 | 0,73 | 0,0511 | 0,0041 | 1,03 | 0,0715 | 0,0060 | 1,03 | 0,0715 | 0,0094 | 1,52 | 0,0817 | 0,0076 | 1,52 | 0,0817 | 0,0119 |
| A14- | Dornbirn Süd Lustenau | Hohenems | 1,03 | 0,0718 | 0,0037 | 1,03 | 0,0718 | 0,0058 | 1,45 | 0,1006 | 0,0084 | 1,45 | 0,1006 | 0,0133 | 2,13 | 0,1149 | 0,0106 | 2,14 | 0,1149 | 0,0167 |
| A14- | Hohenems | Altach Götzis | 0,67 | 0,0468 | 0,0024 | 0,67 | 0,0468 | 0,0038 | 0,94 | 0,0656 | 0,0055 | 0,95 | 0,0656 | 0,0087 | 1,39 | 0,0749 | 0,0069 | 1,39 | 0,0749 | 0,0109 |
| A14- | Altach Götzis | Götzis | 0,51 | 0,0357 | 0,0018 | 0,51 | 0,0357 | 0,0029 | 0,72 | 0,0500 | 0,0042 | 0,72 | 0,0500 | 0,0066 | 1,06 | 0,0571 | 0,0053 | 1,06 | 0,0571 | 0,0083 |
| A14- | Götzis | Klaus Koblach | 0,45 | 0,0310 | 0,0016 | 0,45 | 0,0310 | 0,0025 | 0,62 | 0,0434 | 0,0036 | 0,63 | 0,0434 | 0,0057 | 0,92 | 0,0496 | 0,0046 | 0,92 | 0,0496 | 0,0072 |
| A14- | Klaus Koblach | Rankweil | 0,78 | 0,0545 | 0,0028 | 0,78 | 0,0545 | 0,0044 | 1,10 | 0,0763 | 0,0064 | 1,10 | 0,0763 | 0,0101 | 1,62 | 0,0872 | 0,0081 | 1,62 | 0,0872 | 0,0127 |
| A14- | Rankweil | Feldkirch Frastanz | 1,11 | 0,0777 | 0,0040 | 1,12 | 0,0777 | 0,0062 | 1,56 | 0,1087 | 0,0091 | 1,57 | 0,1087 | 0,0143 | 2,30 | 0,1242 | 0,0115 | 2,31 | 0,1242 | 0,0181 |
| A14- | Feldkirch Frastanz | Nenzing Bludesch | 1,76 | 0,1228 | 0,0063 | 1,77 | 0,1228 | 0,0099 | 2,47 | 0,1719 | 0,0144 | 2,48 | 0,1719 | 0,0227 | 3,64 | 0,1965 | 0,0182 | 3,65 | 0,1965 | 0,0286 |
| A14- | Nenzing Bludesch | Bludenz Nüziders | 1,31 | 0,0912 | 0,0047 | 1,31 | 0,0912 | 0,0073 | 1,84 | 0,1276 | 0,0107 | 1,84 | 0,1276 | 0,0168 | 2,71 | 0,1459 | 0,0135 | 2,71 | 0,1459 | 0,0212 |
| A14- | Bludenz Nüziders | Brandnertal | 0,18 | 0,0127 | 0,0006 | 0,18 | 0,0127 | 0,0010 | 0,26 | 0,0178 | 0,0015 | 0,26 | 0,0178 | 0,0023 | 0,38 | 0,0203 | 0,0019 | 0,38 | 0,0203 | 0,0030 |
| A14- | Brandnertal | Bludenz Bürs | 0,30 | 0,0212 | 0,0011 | 0,30 | 0,0212 | 0,0017 | 0,43 | 0,0296 | 0,0025 | 0,43 | 0,0296 | 0,0039 | 0,63 | 0,0339 | 0,0031 | 0,63 | 0,0339 | 0,0049 |
| A14- | Bludenz Bürs | Bludenz Montafon | 0,43 | 0,0300 | 0,0015 | 0,43 | 0,0300 | 0,0024 | 0,60 | 0,0420 | 0,0035 | 0,61 | 0,0420 | 0,0055 | 0,89 | 0,0480 | 0,0044 | 0,89 | 0,0480 | 0,0070 |
| A141 | KN Bregenz | Bregenz Citytunnel | 0,39 | 0,0275 | 0,0014 | 0,40 | 0,0275 | 0,0022 | 0,55 | 0,0385 | 0,0032 | 0,56 | 0,0385 | 0,0051 | 0,82 | 0,0440 | 0,0041 | 0,82 | 0,0440 | 0,0064 |
| A21- | KN Steinhäusl | Hochstraß | 0,65 | 0,0453 | 0,0023 | 0,65 | 0,0453 | 0,0036 | 0,91 | 0,0635 | 0,0053 | 0,92 | 0,0635 | 0,0084 | 1,35 | 0,0725 | 0,0067 | 1,35 | 0,0725 | 0,0106 |
| A21- | Hochstraß | Alland | 2,27 | 0,1584 | 0,0081 | 2,28 | 0,1584 | 0,0127 | 3,19 | 0,2217 | 0,0186 | 3,20 | 0,2217 | 0,0292 | 4,70 | 0,2534 | 0,0235 | 4,71 | 0,2534 | 0,0369 |
| A21- | Alland | Mayerling | 0,46 | 0,0322 | 0,0016 | 0,46 | 0,0322 | 0,0026 | 0,65 | 0,0450 | 0,0038 | 0,65 | 0,0450 | 0,0059 | 0,95 | 0,0514 | 0,0048 | 0,96 | 0,0514 | 0,0075 |
| A21- | Mayerling | Heiligenkreuz | 1,07 | 0,0745 | 0,0038 | 1,07 | 0,0745 | 0,0060 | 1,50 | 0,1043 | 0,0088 | 1,51 | 0,1043 | 0,0138 | 2,21 | 0,1192 | 0,0110 | 2,22 | 0,1192 | 0,0173 |
| A21- | Heiligenkreuz | Heiligenbrühl | 0,60 | 0,0415 | 0,0021 | 0,60 | 0,0415 | 0,0033 | 0,84 | 0,0581 | 0,0049 | 0,84 | 0,0581 | 0,0077 | 1,23 | 0,0664 | 0,0062 | 1,24 | 0,0664 | 0,0097 |
| A21- | Hinterbrühl | Gießhübl | 1,12 | 0,0779 | 0,0040 | 1,12 | 0,0779 | 0,0063 | 1,57 | 0,1090 | 0,0092 | 1,57 | 0,1090 | 0,0144 | 2,31 | 0,1246 | 0,0115 | 2,32 | 0,1246 | 0,0181 |
| A21- | Gießhübl | Brunn/Gebirge | 0,94 | 0,0652 | 0,0033 | 0,94 | 0,0652 | 0,0052 | 1,31 | 0,0912 | 0,0077 | 1,32 | 0,0912 | 0,0120 | 1,93 | 0,1043 | 0,0097 | 1,94 | 0,1043 | 0,0152 |
| A21- | Brunn/Gebirge | KN Vösendorf | 0,42 | 0,0290 | 0,0015 | 0,42 | 0,0290 | 0,0023 | 0,58 | 0,0406 | 0,0034 | 0,59 | 0,0406 | 0,0054 | 0,86 | 0,0464 | 0,0043 | 0,86 | 0,0464 | 0,0068 |
| A22- | KN Wien Kaisermühlen | Kaisermühlen | 0,33 | 0,0229 | 0,0012 | 0,33 | 0,0229 | 0,0018 | 0,46 | 0,0321 | 0,0027 | 0,46 | 0,0321 | 0,0042 | 0,68 | 0,0367 | 0,0034 | 0,68 | 0,0367 | 0,0053 |
| A22- | Kaisermühlen | Reichsbrücke | 0,27 | 0,0190 | 0,0010 | 0,27 | 0,0190 | 0,0015 | 0,38 | 0,0266 | 0,0022 | 0,38 | 0,0266 | 0,0035 | 0,56 | 0,0304 | 0,0028 | 0,57 | 0,0304 | 0,0044 |
| A22- | Reichsbrücke | Kagran Vienna International Center | 0,11 | 0,0073 | 0,0004 | 0,11 | 0,0073 | 0,0006 | 0,15 | 0,0102 | 0,0009 | 0,15 | 0,0102 | 0,0014 | 0,22 | 0,0117 | 0,0011 | 0,22 | 0,0117 | 0,0017 |
| A22- | Kagran Vienna International Center | Brigittenuerbrücke | 0,17 | 0,0117 | 0,0006 | 0,17 | 0,0117 | 0,0009 | 0,24 | 0,0164 | 0,0014 | 0,24 | 0,0164 | 0,0022 | 0,35 | 0,0187 | 0,0017 | 0,35 | 0,0187 | 0,0027 |
| A22- | Brigittenuerbrücke | Floridsdorferbrücke | 0,27 | 0,0189 | 0,0010 | 0,27 | 0,0189 | 0,0015 | 0,38 | 0,0265 | 0,0022 | 0,38 | 0,0265 | 0,0035 | 0,56 | 0,0302 | 0,0028 | 0,56 | 0,0302 | 0,0044 |
| A22- | Floridsdorferbrücke | KN Gürtel Nordbrücke | 0,17 | 0,0121 | 0,0006 | 0,17 | 0,0121 | 0,0010 | 0,24 | 0,0169 | 0,0014 | 0,24 | 0,0169 | 0,0022 | 0,36 | 0,0193 | 0,0018 | 0,36 | 0,0193 | 0,0028 |
| A22- | KN Gürtel Nordbrücke | Strebersdorf | 0,59 | 0,0412 | 0,0021 | 0,59 | 0,0412 | 0,0033 | 0,83 | 0,0577 | 0,0048 | 0,83 | 0,0577 | 0,0076 | 1,22 | 0,0659 | 0,0061 | 1,23 | 0,0659 | 0,0096 |
| A221 | Wien Nordbrücke | KN Gürtel Nordbrücke | 0,17 | 0,0122 | 0,0006 | 0,17 | 0,0122 | 0,0010 | 0,24 | 0,0170 | 0,0014 | 0,25 | 0,0170 | 0,0022 | 0,36 | 0,0194 | 0,0018 | 0,36 | 0,0194 | 0,0028 |
| A221 | KN Gürtel Nordbrücke | Wien Pragerstraße | 0,19 | 0,0131 | 0,0007 | 0,19 | 0,0131 | 0,0011 | 0,26 | 0,0183 | 0,0015 | 0,26 | 0,0183 | 0,0024 | 0,39 | 0,0209 | 0,0019 | 0,39 | 0,0209 | 0,0030 |
| A221 | Wien Pragerstraße | Wien Neujedlersdorf | 0,08 | 0,0057 | 0,0003 | 0,08 | 0,0057 | 0,0005 | 0,12 | 0,0080 | 0,0007 | 0,12 | 0,0080 | 0,0011 | 0,17 | 0,0092 | 0,0008 | 0,17 | 0,0092 | 0,0013 |
| A221 | Wien Neujedlersdorf | Brünnerstr/Shuttlewortstraße | 0,21 | 0,0145 | 0,0007 | 0,21 | 0,0145 | 0,0012 | 0,29 | 0,0203 | 0,0017 | 0,29 | 0,0203 | 0,0027 | 0,43 | 0,0232 | 0,0022 | 0,43 | 0,0232 | 0,0034 |
| A22- | Strebersdorf | Korneuburg Ost | 1,19 | 0,0830 | 0,0042 | 1,19 | 0,0830 | 0,0067 | 1,67 | 0,1162 | 0,0098 | 1,68 | 0,1162 | 0,0153 | 2,46 | 0,1328 | 0,0123 | 2,47 | 0,1328 | 0,0193 |
| A222 | Strebersdorf | Wien Vohburggasse | 0,15 | 0,0103 | 0,0005 | 0,15 | 0,0103 | 0,0008 | 0,21 | 0,0144 | 0,0012 | 0,21 | 0,0144 | 0,0019 | 0,31 | 0,0165 | 0,0015 | 0,31 | 0,0165 | 0,0024 |
| A22- | Korneuburg Ost | KN Korneuburg | 0,77 | 0,0536 | 0,0027 | 0,77 | 0,0536 | 0,0043 | 1,08 | 0,0750 | 0,0063 | 1,08 | 0,0750 | 0,0099 | 1,59 | 0,0857 | 0,0079 | 1,59 | 0,0857 | 0,0125 |
| A22- | KN Korneuburg | Stockerau Ost | 1,12 | 0,0780 | 0,0040 | 1,12 | 0,0780 | 0,0063 | 1,57 | 0,1091 | 0,0092 | 1,57 | 0,1091 | 0,0144 | 2,31 | 0,1247 | 0,0116 | 2,32 | 0,1247 | 0,0182 |
| A22- | Stockerau Ost | Stockerau Mitte | 0,45 | 0,0311 | 0,0016 | 0,45 | 0,0311 | 0,0025 | 0,63 | 0,0435 | 0,0037 | 0,63 | 0,0435 | 0,0057 | 0,92 | 0,0497 | 0,0046 | 0,93 | 0,0497 | 0,0072 |
| A22- | Stockerau Mitte | KN Stockerau/West | 0,38 | 0,0264 | 0,0013 | 0,38 | 0,0264 | 0,0021 | 0,53 | 0,0370 | 0,0031 | 0,53 | 0,0370 | 0,0049 | 0,78 | 0,0422 | 0,0039 | 0,79 | 0,0422 | 0,0061 |
| A23- | Altmannsdorferstraße | KN Wien Inzersdorf | 0,33 | 0,0231 | 0,0012 | 0,33 | 0,0231 | 0,0019 | 0,47 | 0,0323 | 0,0027 | 0,47 | 0,0323 | 0,0043 | 0,69 | 0,0370 | 0,0034 | 0,69 | 0,0370 | 0,0054 |
| A23- | KN Wien Inzersdorf | Favoriten | 0,84 | 0,0583 | 0,0030 | 0,84 | 0,0583 | 0,0047 | 1,17 | 0,0816 | 0,0068 | 1,18 | 0,0816 | 0,0108 | 1,73 | 0,0932 | 0,0086 | 1,73 | 0,0932 | 0,0136 |
| A23- | Favoriten | KN Gürtel Landstraßer Hauptstraße | 0,52 | 0,0365 | 0,0019 | 0,52 | 0,0365 | 0,0029 | 0,73 | 0,0511 | 0,0043 | 0,74 | 0,0511 | 0,0067 | 1,08 | 0,0584 | 0,0054 | 1,09 | 0,0584 | 0,0085 |
| A23- | KN Gürtel Landstraßer Hauptstraße | St. Marx | 0,20 | 0,0139 | 0,0007 | 0,20 | 0,0139 | 0,0011 | 0,28 | 0,0194 | 0,0016 | 0,28 | 0,0194 | 0,0026 | 0,41 | 0,0222 | 0,0021 | 0,41 | 0,0222 | 0,0032 |
| A23- | St. Marx | KN Wien Prater | 0,17 | 0,0118 | 0,0006 | 0,17 | 0,0118 | 0,0009 | 0,24 | 0,0165 | 0,0014 | 0,24 | 0,0165 | 0,0022 | 0,35 | 0,0188 | 0,0017 | 0,35 | 0,0188 | 0,0027 |
| A23- | KN Wien Prater | Handelskai | 0,37 | 0,0261 | 0,0013 | 0,38 | 0,0261 | 0,0021 | 0,53 | 0,0365 | 0,0031 | 0,53 | 0,0365 | 0,0048 | 0,77 | 0,0418 | 0,0039 | 0,78 | 0,0418 | 0,0061 |
| A23- | Handelskai | KN Wien Kaisermühlen | 0,17 | 0,0119 | 0,0006 | 0,17 | 0,0119 | 0,0010 | 0,24 | 0,0167 | 0,0014 | 0,24 | 0,0167 | 0,0022 | 0,35 | 0,0191 | 0,0018 | 0,36 | 0,0191 | 0,0028 |
| A23- | KN Wien Kaisermühlen | Groß Enzersdorf Stadlau | 0,47 | 0,0327 | 0,0017 | 0,47 | 0,0327 | 0,0026 | 0,66 | 0,0458 | 0,0038 | 0,66 | 0,0458 | 0,0060 | 0,97 | 0,0524 | 0,0049 | 0,97 | 0,0524 | 0,0076 |
| A23- | Groß Enzersdorf Stadlau | Hirschstetten | 0,26 | 0,0184 | 0,0009 | 0,26 | 0,0184 | 0,0015 | 0,37 | 0,0257 | 0,0022 | 0,37 | 0,0257 | 0,0034 | 0,54 | 0,0294 | 0,0027 | 0,55 | 0,0294 | 0,0043 |
| A233 | KN Gürtel Landstraßer Hauptstraße | Wien Gürtel | 0,15 | 0,0107 | 0,0005 | 0,15 | 0,0107 | 0,0009 | 0,22 | 0,0150 | 0,0013 | 0,22 | 0,0150 | 0,0020 | 0,32 | 0,0171 | 0,0016 | 0,32 | 0,0171 | 0,0025 |
| A25- | KN A1/A25 Passau Wels | Weißkirchen | 1,73 | 0,1208 | 0,0062 | 1,74 | 0,1208 | 0,0097 | 2,43 | 0,1691 | 0,0142 | 2,44 | 0,1691 | 0,0223 | 3,58 | 0,1932 | 0,0179 | 3,59 | 0,1932 | 0,0281 |
| A25- | Weißkirchen | Marchtrenk Wels Ost | 0,62 | 0,0430 | 0,0022 | 0,62 | 0,0430 | 0,0035 | 0,87 | 0,0602 | 0,0051 | 0,87 | 0,0602 | 0,0079 | 1,28 | 0,0689 | 0,0064 | 1,28 | 0,0689 | 0,0100 |
| A25- | Marchtrenk Wels Ost | ÖBB Terminal Wels | 0,17 | 0,0116 | 0,0006 | 0,17 | 0,0116 | 0,0009 | 0,23 | 0,0162 | 0,0014 | 0,23 | 0,0162 | 0,0021 | 0,34 | 0,0185 | 0,0017 | 0,34 | 0,0185 | 0,0027 |
| | | | | | | | | | | | | | | | | | | | | |

| | | | | | | | | | | | | | | | | | | | | |
|------|-----------------------------------|-----------------------------------|------|--------|--------|------|----------|--------|------|--------|--------|------|--------|--------|------|--------|--------|------|--------|--------|
| S01- | Seyring | KN Eibesbrunn | 0,81 | 0,0565 | 0,0029 | 0,81 | 0,0565 | 0,0045 | 1,14 | 0,0791 | 0,0066 | 1,14 | 0,0791 | 0,0104 | 1,68 | 0,0904 | 0,0084 | 1,68 | 0,0904 | 0,0131 |
| S01- | KN Eibesbrunn | Hagenbrunn | 0,64 | 0,0445 | 0,0023 | 0,64 | 0,0445 | 0,0036 | 0,90 | 0,0622 | 0,0052 | 0,90 | 0,0622 | 0,0082 | 1,32 | 0,0711 | 0,0066 | 1,32 | 0,0711 | 0,0104 |
| S01- | Hagenbrunn | Korneuburg Nord | 1,36 | 0,0951 | 0,0049 | 1,37 | 0,0951 | 0,0076 | 1,92 | 0,1331 | 0,0112 | 1,92 | 0,1331 | 0,0176 | 2,82 | 0,1522 | 0,0141 | 2,83 | 0,1522 | 0,0221 |
| S01- | Korneuburg Nord | Korneuburg West | 0,55 | 0,0386 | 0,0020 | 0,55 | 0,0386 | 0,0031 | 0,78 | 0,0540 | 0,0045 | 0,78 | 0,0540 | 0,0071 | 1,14 | 0,0617 | 0,0057 | 1,15 | 0,0617 | 0,0090 |
| S01- | Korneuburg West | KN Korneuburg | 0,18 | 0,0123 | 0,0006 | 0,18 | 0,0123 | 0,0010 | 0,25 | 0,0172 | 0,0014 | 0,25 | 0,0172 | 0,0023 | 0,37 | 0,0197 | 0,0018 | 0,37 | 0,0197 | 0,0029 |
| S02- | Hirschstetten | Gewerbepark Stadlau | 0,19 | 0,0132 | 0,0007 | 0,19 | 0,0132 | 0,0011 | 0,27 | 0,0185 | 0,0016 | 0,27 | 0,0185 | 0,0024 | 0,39 | 0,0212 | 0,0020 | 0,39 | 0,0212 | 0,0031 |
| S02- | Gewerbepark Stadlau | Breitenleer Straße | 0,11 | 0,0073 | 0,0004 | 0,11 | 0,0073 | 0,0006 | 0,15 | 0,0103 | 0,0009 | 0,15 | 0,0103 | 0,0014 | 0,22 | 0,0117 | 0,0011 | 0,22 | 0,0117 | 0,0017 |
| S02- | Breitenleer Straße | Rautenweg | 0,17 | 0,0122 | 0,0006 | 0,18 | 0,0122 | 0,0010 | 0,24 | 0,0170 | 0,0014 | 0,25 | 0,0170 | 0,0022 | 0,36 | 0,0195 | 0,0018 | 0,36 | 0,0195 | 0,0028 |
| S02- | Rautenweg | Hermann Gebauer Straße | 0,19 | 0,0134 | 0,0007 | 0,19 | 0,0134 | 0,0011 | 0,27 | 0,0187 | 0,0016 | 0,27 | 0,0187 | 0,0025 | 0,40 | 0,0214 | 0,0020 | 0,40 | 0,0214 | 0,0031 |
| S02- | Hermann Gebauer Straße | Angerner Straße | 0,69 | 0,0484 | 0,0025 | 0,70 | 0,0484 | 0,0039 | 0,97 | 0,0677 | 0,0057 | 0,98 | 0,0677 | 0,0089 | 1,44 | 0,0774 | 0,0072 | 1,44 | 0,0774 | 0,0113 |
| S03- | KN Stockerau/West | Stockerau Nord | 0,20 | 0,0137 | 0,0007 | 0,20 | 0,0137 | 0,0011 | 0,28 | 0,0191 | 0,0016 | 0,28 | 0,0191 | 0,0025 | 0,41 | 0,0219 | 0,0020 | 0,41 | 0,0219 | 0,0032 |
| S03- | Stockerau Nord | Sierndorf | 1,05 | 0,0735 | 0,0038 | 1,06 | 0,0735 | 0,0059 | 1,48 | 0,1029 | 0,0086 | 1,48 | 0,1029 | 0,0136 | 2,18 | 0,1176 | 0,0109 | 2,19 | 0,1176 | 0,0171 |
| S03- | Sierndorf | Obermallebarn | 0,71 | 0,0493 | 0,0025 | 0,71 | 0,0493 | 0,0040 | 0,99 | 0,0691 | 0,0058 | 1,00 | 0,0691 | 0,0091 | 1,46 | 0,0790 | 0,0073 | 1,47 | 0,0790 | 0,0115 |
| S03- | Obermallebarn | Göllersdorf | 0,94 | 0,0652 | 0,0033 | 0,94 | 0,0652 | 0,0052 | 1,31 | 0,0912 | 0,0077 | 1,32 | 0,0912 | 0,0120 | 1,93 | 0,1043 | 0,0097 | 1,94 | 0,1043 | 0,0152 |
| S03- | Göllersdorf | Großstelzendorf | 0,37 | 0,0261 | 0,0013 | 0,38 | 0,0261 | 0,0021 | 0,53 | 0,0365 | 0,0031 | 0,53 | 0,0365 | 0,0048 | 0,77 | 0,0418 | 0,0039 | 0,78 | 0,0418 | 0,0061 |
| S03- | Großstelzendorf | Hollabrunn Süd | 0,90 | 0,0628 | 0,0032 | 0,90 | 0,0628 | 0,0050 | 1,26 | 0,0879 | 0,0074 | 1,27 | 0,0879 | 0,0116 | 1,86 | 0,1004 | 0,0093 | 1,87 | 0,1004 | 0,0146 |
| S04- | KN Mattersburg | Sigleß | 0,47 | 0,0324 | 0,0017 | 0,47 | 0,0324 | 0,0026 | 0,65 | 0,0454 | 0,0038 | 0,66 | 0,0454 | 0,0060 | 0,96 | 0,0519 | 0,0048 | 0,97 | 0,0519 | 0,0076 |
| S04- | Sigleß | Bad Sauerbrunn | 1,09 | 0,0758 | 0,0039 | 1,09 | 0,0758 | 0,0061 | 1,53 | 0,1061 | 0,0089 | 1,53 | 0,1061 | 0,0140 | 2,25 | 0,1213 | 0,0112 | 2,26 | 0,1213 | 0,0177 |
| S04- | Bad Sauerbrunn | Neudörfel | 0,46 | 0,0319 | 0,0016 | 0,46 | 0,0319 | 0,0026 | 0,64 | 0,0446 | 0,0037 | 0,64 | 0,0446 | 0,0059 | 0,95 | 0,0510 | 0,0047 | 0,95 | 0,0510 | 0,0074 |
| S04- | Neudörfel | Wr. Neustadt Ost | 0,48 | 0,0333 | 0,0017 | 0,48 | 0,0333 | 0,0027 | 0,67 | 0,0467 | 0,0039 | 0,67 | 0,0467 | 0,0062 | 0,99 | 0,0534 | 0,0049 | 0,99 | 0,0534 | 0,0078 |
| S04- | Wr. Neustadt Ost | Katzelsdorf | 0,22 | 0,0156 | 0,0008 | 0,22 | 0,0156 | 0,0013 | 0,31 | 0,0219 | 0,0018 | 0,32 | 0,0219 | 0,0029 | 0,46 | 0,0250 | 0,0023 | 0,46 | 0,0250 | 0,0036 |
| S04- | Katzelsdorf | Lanzenkirchen | 0,19 | 0,0131 | 0,0007 | 0,19 | 0,0131 | 0,0010 | 0,26 | 0,0183 | 0,0015 | 0,26 | 0,0183 | 0,0024 | 0,39 | 0,0209 | 0,0019 | 0,39 | 0,0209 | 0,0030 |
| S04- | Lanzenkirchen | Wr. Neustadt Süd | 0,17 | 0,0116 | 0,0006 | 0,17 | 0,0116 | 0,0009 | 0,23 | 0,0162 | 0,0014 | 0,23 | 0,0162 | 0,0021 | 0,34 | 0,0185 | 0,0017 | 0,34 | 0,0185 | 0,0027 |
| S04- | Wr. Neustadt Süd | KN Wr. Neustadt | 0,28 | 0,0192 | 0,0010 | 0,28 | 0,0192 | 0,0015 | 0,39 | 0,0269 | 0,0023 | 0,39 | 0,0269 | 0,0035 | 0,57 | 0,0307 | 0,0028 | 0,57 | 0,0307 | 0,0045 |
| S05- | KN Stockerau/West | Tulln | 1,90 | 0,1323 | 0,0068 | 1,90 | 0,1323 | 0,0106 | 2,67 | 0,1853 | 0,0156 | 2,67 | 0,1853 | 0,0244 | 3,93 | 0,2117 | 0,0196 | 3,94 | 0,2117 | 0,0308 |
| S05- | Tulln | Königsbrunn / Wagram | 2,38 | 0,1658 | 0,0085 | 2,38 | 0,1658 | 0,0133 | 3,34 | 0,2321 | 0,0195 | 3,35 | 0,2321 | 0,0306 | 4,92 | 0,2652 | 0,0246 | 4,93 | 0,2652 | 0,0386 |
| S05- | Königsbrunn / Wagram | Kirchberg/Wagram | 0,63 | 0,0442 | 0,0023 | 0,64 | 0,0442 | 0,0035 | 0,89 | 0,0619 | 0,0052 | 0,89 | 0,0619 | 0,0082 | 1,31 | 0,0707 | 0,0065 | 1,31 | 0,0707 | 0,0103 |
| S05- | Kirchberg/Wagram | Fels / Wagram | 0,48 | 0,0331 | 0,0017 | 0,48 | 0,0331 | 0,0027 | 0,67 | 0,0463 | 0,0039 | 0,67 | 0,0463 | 0,0061 | 0,98 | 0,0530 | 0,0049 | 0,99 | 0,0530 | 0,0077 |
| S05- | Fels / Wagram | Grafenwörth | 1,09 | 0,0762 | 0,0039 | 1,10 | 0,0762 | 0,0061 | 1,53 | 0,1067 | 0,0090 | 1,54 | 0,1067 | 0,0141 | 2,26 | 0,1219 | 0,0113 | 2,27 | 0,1219 | 0,0177 |
| S05- | Grafenwörth | Jettsdorf | 0,49 | 0,0341 | 0,0017 | 0,49 | 0,0341 | 0,0027 | 0,69 | 0,0477 | 0,0040 | 0,69 | 0,0477 | 0,0063 | 1,01 | 0,0545 | 0,0050 | 1,01 | 0,0545 | 0,0079 |
| S06- | KN Seebenstein | Neunkirchen | 0,75 | 0,0520 | 0,0027 | 0,75 | 0,0520 | 0,0042 | 1,05 | 0,0728 | 0,0061 | 1,05 | 0,0728 | 0,0096 | 1,54 | 0,0832 | 0,0077 | 1,55 | 0,0832 | 0,0121 |
| S06- | Neunkirchen | Gloggnitz | 2,39 | 0,1667 | 0,0085 | 2,40 | 0,1667 | 0,0134 | 3,36 | 0,2334 | 0,0196 | 3,37 | 0,2334 | 0,0308 | 4,95 | 0,2668 | 0,0247 | 4,96 | 0,2668 | 0,0388 |
| S06- | Gloggnitz | Maria Schutz | 1,53 | 0,1063 | 0,0054 | 1,53 | 0,1063 | 0,0085 | 2,14 | 0,1488 | 0,0125 | 2,15 | 0,1488 | 0,0196 | 3,15 | 0,1700 | 0,0157 | 3,16 | 0,1700 | 0,0247 |
| S06- | Maria Schutz | Spital / Semmering | 1,29 | 0,0902 | 0,0046 | 1,30 | 0,0902 | 0,0072 | 1,82 | 0,1263 | 0,0106 | 1,82 | 0,1263 | 0,0167 | 2,68 | 0,1443 | 0,0134 | 2,68 | 0,1443 | 0,0210 |
| S06- | Spital / Semmering | Mürzzuschlag Ost | 1,08 | 0,0754 | 0,0039 | 1,08 | 0,0754 | 0,0061 | 1,52 | 0,1055 | 0,0089 | 1,52 | 0,1055 | 0,0139 | 2,24 | 0,1206 | 0,0112 | 2,24 | 0,1206 | 0,0175 |
| S06- | Mürzzuschlag Ost | Mariazell, Mürzsteg, Mürzzuschlag | 0,96 | 0,0668 | 0,0034 | 0,96 | 0,0668 | 0,0054 | 1,35 | 0,0935 | 0,0079 | 1,35 | 0,0935 | 0,0123 | 1,98 | 0,1069 | 0,0099 | 1,99 | 0,1069 | 0,0156 |
| S06- | Mariazell, Mürzsteg, Mürzzuschlag | Hönigsberg | 0,68 | 0,0476 | 0,0024 | 0,68 | 0,0476 | 0,0038 | 0,96 | 0,0667 | 0,0056 | 0,96 | 0,0667 | 0,0088 | 1,41 | 0,0762 | 0,0071 | 1,42 | 0,0762 | 0,0111 |
| S06- | Hönigsberg | Langenwang | 0,38 | 0,0263 | 0,0013 | 0,38 | 0,0263 | 0,0021 | 0,53 | 0,0369 | 0,0031 | 0,53 | 0,0369 | 0,0049 | 0,78 | 0,0422 | 0,0039 | 0,78 | 0,0422 | 0,0061 |
| S06- | Langenwang | Krieglach | 0,45 | 0,0313 | 0,0016 | 0,45 | 0,0313 | 0,0025 | 0,63 | 0,0438 | 0,0037 | 0,63 | 0,0438 | 0,0058 | 0,93 | 0,0501 | 0,0046 | 0,93 | 0,0501 | 0,0073 |
| S06- | Krieglach | Mitterdorf | 1,13 | 0,0791 | 0,0040 | 1,14 | 0,0791 | 0,0064 | 1,59 | 0,1107 | 0,0093 | 1,60 | 0,1107 | 0,0146 | 2,35 | 0,1265 | 0,0117 | 2,35 | 0,1265 | 0,0184 |
| S06- | Mitterdorf | Kindberg Ost | 1,15 | 0,0804 | 0,0041 | 1,16 | 0,0804 | 0,0065 | 1,62 | 0,1126 | 0,0095 | 1,62 | 0,1126 | 0,0149 | 2,39 | 0,1287 | 0,0119 | 2,39 | 0,1287 | 0,0187 |
| S06- | Kindberg Ost | Kindberg West | 0,25 | 0,0173 | 0,0009 | 0,25 | 0,0173 | 0,0014 | 0,35 | 0,0242 | 0,0020 | 0,35 | 0,0242 | 0,0032 | 0,51 | 0,0276 | 0,0026 | 0,51 | 0,0276 | 0,0040 |
| S06- | Kindberg West | Kindberg Dörfel | 0,25 | 0,0172 | 0,0009 | 0,25 | 0,0172 | 0,0014 | 0,35 | 0,0241 | 0,0020 | 0,35 | 0,0241 | 0,0032 | 0,51 | 0,0276 | 0,0026 | 0,51 | 0,0276 | 0,0040 |
| S06- | Kindberg Dörfel | Allerheiligen Mürzhofen | 0,56 | 0,0389 | 0,0020 | 0,56 | 0,0389 | 0,0031 | 0,78 | 0,0544 | 0,0046 | 0,79 | 0,0544 | 0,0072 | 1,15 | 0,0622 | 0,0058 | 1,16 | 0,0622 | 0,0090 |
| S06- | Allerheiligen Mürzhofen | St. Marein | 0,84 | 0,0584 | 0,0030 | 0,84 | 0,0584 | 0,0047 | 1,18 | 0,0817 | 0,0069 | 1,18 | 0,0817 | 0,0108 | 1,73 | 0,0934 | 0,0086 | 1,74 | 0,0934 | 0,0136 |
| S06- | St. Marein | Kapfenberg | 0,59 | 0,0414 | 0,0021 | 0,59 | 0,0414 | 0,0033 | 0,83 | 0,0579 | 0,0049 | 0,84 | 0,0579 | 0,0076 | 1,23 | 0,0662 | 0,0061 | 1,23 | 0,0662 | 0,0096 |
| S06- | Kapfenberg | KN Bruck/Mur | 1,11 | 0,0772 | 0,0039 | 1,11 | 0,0772 | 0,0062 | 1,56 | 0,1081 | 0,0091 | 1,56 | 0,1081 | 0,0143 | 2,29 | 0,1236 | 0,0114 | 2,30 | 0,1236 | 0,0180 |
| S06- | KN Bruck/Mur | ASt Bruck/Mur | 0,95 | 0,0663 | 0,0034 | 0,95 | 0,0663 | 0,0053 | 1,33 | 0,0928 | 0,0078 | 1,34 | 0,0928 | 0,0122 | 1,97 | 0,1060 | 0,0098 | 1,97 | 0,1060 | 0,0154 |
| S06- | ASt Bruck/Mur | Niklasdorf | 0,88 | 0,0612 | 0,0031 | 0,88 | 0,0612 | 0,0049 | 1,23 | 0,0857 | 0,0072 | 1,24 | 0,0857 | 0,0113 | 1,82 | 0,0979 | 0,0091 | 1,82 | 0,0979 | 0,0143 |
| S06- | Niklasdorf | Leoben Ost | 0,94 | 0,0653 | 0,0033 | 0,94 | 0,0653 | 0,0052 | 1,31 | 0,0914 | 0,0077 | 1,32 | 0,0914 | 0,0121 | 1,94 | 0,1045 | 0,0097 | 1,94 | 0,1045 | 0,0152 |
| S06- | Leoben Ost | Leoben West | 1,05 | 0,0731 | 0,0037 | 1,05 | 0,0731 | 0,0059 | 1,47 | 0,1024 | 0,0086 | 1,48 | 0,1024 | 0,0135 | 2,17 | 0,1170 | 0,0108 | 2,18 | 0,1170 | 0,0170 |
| S06- | Leoben West | St. Michael | 1,00 | 0,0694 | 0,0035 | 1,00 | 0,0694 | 0,0056 | 1,40 | 0,0972 | 0,0082 | 1,40 | 0,0972 | 0,0128 | 2,06 | 0,1111 | 0,0103 | 2,07 | 0,1111 | 0,0162 |
| S06- | St. Michael | KN St. Michael | 0,30 | 0,0211 | 0,0011 | 0,30 | 0,0211 | 0,0017 | 0,43 | 0,0296 | 0,0025 | 0,43 | 0,0296 | 0,0039 | 0,63 | 0,0338 | 0,0031 | 0,63 | 0,0338 | 0,0049 |
| S10- | Unterweikersdorf | Neumarkt | 1,32 | 0,0917 | 0,0047 | 1,32 | 0,0917 | 0,0074 | 1,85 | 0,1284 | 0,0108 | 1,85 | 0,1284 | 0,0169 | 2,72 | 0,1468 | 0,0136 | 2,73 | 0,1468 | 0,0214 |
| S10- | Neumarkt | Kefermarkt | 0,76 | 0,0527 | 0,0027 | 0,76 | 0,0527 | 0,0042 | 1,06 | 0,0738 | 0,0062 | 1,06 | 0,0738 | 0,0097 | 1,56 | 0,0843 | 0,0078 | 1,57 | 0,0843 | 0,0123 |
| S10- | Kefermarkt | Freistadt / Süd | 0,81 | 0,0567 | 0,0029 | 0,82 | 0,0567 | 0,0046 | 1,14 | 0,0793 | 0,0067 | 1,15 | 0,0793 | 0,0105 | 1,68 | 0,0907 | 0,0084 | 1,69 | 0,0907 | 0,0132 |
| S10- | Freistadt / Süd | Grünbach Sandl | 0,86 | 0,0600 | 0,0031 | 0,86 | 0,0600</ | | | | | | | | | | | | | |

| | | | | | | | | | | | | | | | | | | | | |
|------|-----------------------------|-----------------------------|------|--------|--------|------|--------|--------|------|--------|--------|------|--------|--------|------|--------|----------|------|--------|--------|
| S31- | Eisenstadt Mitte | KN Eisenstadt | 0,37 | 0,0261 | 0,0013 | 0,37 | 0,0261 | 0,0021 | 0,52 | 0,0365 | 0,0031 | 0,53 | 0,0365 | 0,0048 | 0,77 | 0,0417 | 0,0039 | 0,78 | 0,0417 | 0,0061 |
| S31- | KN Eisenstadt | Wulkaprodersdorf | 0,50 | 0,0347 | 0,0018 | 0,50 | 0,0347 | 0,0028 | 0,70 | 0,0486 | 0,0041 | 0,70 | 0,0486 | 0,0064 | 1,03 | 0,0555 | 0,0051 | 1,03 | 0,0555 | 0,0081 |
| S31- | Wulkaprodersdorf | KN Mattersburg | 1,41 | 0,0985 | 0,0050 | 1,42 | 0,0985 | 0,0079 | 1,98 | 0,1379 | 0,0116 | 1,99 | 0,1379 | 0,0182 | 2,92 | 0,1576 | 0,0146 | 2,93 | 0,1576 | 0,0229 |
| S31- | KN Mattersburg | Forchtenstein | 1,02 | 0,0713 | 0,0036 | 1,03 | 0,0713 | 0,0057 | 1,44 | 0,0998 | 0,0084 | 1,44 | 0,0998 | 0,0132 | 2,12 | 0,1140 | 0,0106 | 2,12 | 0,1140 | 0,0166 |
| S31- | Forchtenstein | Sieggraben | 1,43 | 0,0996 | 0,0051 | 1,43 | 0,0996 | 0,0080 | 2,01 | 0,1394 | 0,0117 | 2,01 | 0,1394 | 0,0184 | 2,96 | 0,1594 | 0,0148 | 2,96 | 0,1594 | 0,0232 |
| S31- | Sieggraben | Weppersdorf/Kobersdorf | 1,72 | 0,1200 | 0,0061 | 1,73 | 0,1200 | 0,0096 | 2,42 | 0,1680 | 0,0141 | 2,42 | 0,1680 | 0,0222 | 3,56 | 0,1920 | 0,0178 | 3,57 | 0,1920 | 0,0279 |
| S31- | Weppersdorf/Kobersdorf | Weppersdorf/Markt St.Martin | 0,35 | 0,0246 | 0,0013 | 0,35 | 0,0246 | 0,0020 | 0,50 | 0,0345 | 0,0029 | 0,50 | 0,0345 | 0,0046 | 0,73 | 0,0394 | 0,0037 | 0,73 | 0,0394 | 0,0057 |
| S31- | Weppersdorf/Markt St.Martin | Neutal | 0,82 | 0,0570 | 0,0029 | 0,82 | 0,0570 | 0,0046 | 1,15 | 0,0797 | 0,0067 | 1,15 | 0,0797 | 0,0105 | 1,69 | 0,0911 | 0,0084 | 1,70 | 0,0911 | 0,0133 |
| S31- | Neutal | Stoob Süd | 0,71 | 0,0498 | 0,0025 | 0,72 | 0,0498 | 0,0040 | 1,00 | 0,0697 | 0,0058 | 1,01 | 0,0697 | 0,0092 | 1,48 | 0,0796 | 0,0074 | 1,48 | 0,0796 | 0,0116 |
| S31- | Stoob Süd | Oberpullendorf | 0,78 | 0,0543 | 0,0028 | 0,78 | 0,0543 | 0,0044 | 1,09 | 0,0760 | 0,0064 | 1,10 | 0,0760 | 0,0100 | 1,61 | 0,0869 | 0,0080 | 1,62 | 0,0869 | 0,0126 |
| S33- | KN St. Pölten | St. Pölten Ost | 0,42 | 0,0295 | 0,0015 | 0,42 | 0,0295 | 0,0024 | 0,59 | 0,0413 | 0,0035 | 0,60 | 0,0413 | 0,0054 | 0,88 | 0,0472 | 0,0044 | 0,88 | 0,0472 | 0,0069 |
| S33- | St. Pölten Ost | St. Pölten Nord | 0,75 | 0,0521 | 0,0027 | 0,75 | 0,0521 | 0,0042 | 1,05 | 0,0729 | 0,0061 | 1,05 | 0,0729 | 0,0096 | 1,55 | 0,0834 | 0,0077 | 1,55 | 0,0834 | 0,0121 |
| S33- | St. Pölten Nord | Herzogenburg Süd | 0,79 | 0,0552 | 0,0028 | 0,79 | 0,0552 | 0,0044 | 1,11 | 0,0772 | 0,0065 | 1,11 | 0,0772 | 0,0102 | 1,64 | 0,0883 | 0,0082 | 1,64 | 0,0883 | 0,0128 |
| S33- | Herzogenburg Süd | Herzogenburg Stadt | 0,42 | 0,0295 | 0,0015 | 0,42 | 0,0295 | 0,0024 | 0,59 | 0,0412 | 0,0035 | 0,60 | 0,0412 | 0,0054 | 0,87 | 0,0471 | 0,0044 | 0,88 | 0,0471 | 0,0069 |
| S33- | Herzogenburg Stadt | Herzogenburg Nord | 0,23 | 0,0163 | 0,0008 | 0,23 | 0,0163 | 0,0013 | 0,33 | 0,0229 | 0,0019 | 0,33 | 0,0229 | 0,0030 | 0,48 | 0,0261 | 0,0024 | 0,49 | 0,0261 | 0,0038 |
| S33- | Herzogenburg Nord | Traismauer Süd | 1,14 | 0,0795 | 0,0041 | 1,14 | 0,0795 | 0,0064 | 1,60 | 0,1113 | 0,0093 | 1,61 | 0,1113 | 0,0147 | 2,36 | 0,1272 | 0,0118 | 2,37 | 0,1272 | 0,0185 |
| S33- | Traismauer Süd | Traismauer Nord | 0,58 | 0,0404 | 0,0021 | 0,58 | 0,0404 | 0,0032 | 0,81 | 0,0566 | 0,0047 | 0,82 | 0,0566 | 0,0075 | 1,20 | 0,0647 | 0,0060 | 1,20 | 0,0647 | 0,0094 |
| S33- | Traismauer Nord | Jettsdorf | 0,98 | 0,0683 | 0,0035 | 0,98 | 0,0683 | 0,0055 | 1,37 | 0,0956 | 0,0080 | 1,38 | 0,0956 | 0,0126 | 2,03 | 0,1092 | 0,0101 | 2,03 | 0,1092 | 0,0159 |
| S35- | KN Bruck/Mur | Pernegg | 1,20 | 0,0834 | 0,0043 | 1,20 | 0,0834 | 0,0067 | 1,68 | 0,1168 | 0,0098 | 1,69 | 0,1168 | 0,0154 | 2,48 | 0,1335 | 0,0124 | 2,48 | 0,1335 | 0,0194 |
| S35- | Pernegg | Mixnitz/Mautstatt | 0,87 | 0,0607 | 0,0031 | 0,87 | 0,0607 | 0,0049 | 1,22 | 0,0849 | 0,0071 | 1,23 | 0,0849 | 0,0112 | 1,80 | 0,0971 | 0,0090 | 1,81 | 0,0971 | 0,0141 |
| S35- | Mixnitz/Mautstatt | Röthelstein | 1,04 | 0,0727 | 0,0037 | 1,05 | 0,0727 | 0,0058 | 1,46 | 0,1018 | 0,0085 | 1,47 | 0,1018 | 0,0134 | 2,16 | 0,1164 | 0,0108 | 2,17 | 0,1164 | 0,0169 |
| S35- | Röthelstein | Laufnitzdorf | 0,50 | 0,0351 | 0,0018 | 0,50 | 0,0351 | 0,0028 | 0,71 | 0,0491 | 0,0041 | 0,71 | 0,0491 | 0,0065 | 1,04 | 0,0561 | 0,0052 | 1,04 | 0,0561 | 0,0082 |
| S35- | Laufnitzdorf | Rothleiten | 0,57 | 0,0399 | 0,0020 | 0,57 | 0,0399 | 0,0032 | 0,80 | 0,0558 | 0,0047 | 0,81 | 0,0558 | 0,0074 | 1,18 | 0,0638 | 0,0059 | 1,19 | 0,0638 | 0,0093 |
| S35- | Rothleiten | Frohnleiten Nord | 0,36 | 0,0248 | 0,0013 | 0,36 | 0,0248 | 0,0020 | 0,50 | 0,0348 | 0,0029 | 0,50 | 0,0348 | 0,0046 | 0,74 | 0,0397 | 0,0037 | 0,74 | 0,0397 | 0,0058 |
| S35- | Frohnleiten Nord | Frohnleiten | 0,16 | 0,0115 | 0,0006 | 0,16 | 0,0115 | 0,0009 | 0,23 | 0,0160 | 0,0013 | 0,23 | 0,0160 | 0,0021 | 0,34 | 0,0183 | 0,0017 | 0,34 | 0,0183 | 0,0027 |
| S35- | Frohnleiten | Badl Peggau | 1,10 | 0,0770 | 0,0039 | 1,11 | 0,0770 | 0,0062 | 1,55 | 0,1078 | 0,0090 | 1,56 | 0,1078 | 0,0142 | 2,28 | 0,1232 | 0,0114 | 2,29 | 0,1232 | 0,0179 |
| S35- | Badl Peggau | Peggau Mitte | 0,37 | 0,0258 | 0,0013 | 0,37 | 0,0258 | 0,0021 | 0,52 | 0,0361 | 0,0030 | 0,52 | 0,0361 | 0,0048 | 0,76 | 0,0412 | 0,0038 | 0,77 | 0,0412 | 0,0060 |
| S35- | Peggau Mitte | KN Peggau Deutschfeistritz | 0,77 | 0,0536 | 0,0027 | 0,77 | 0,0536 | 0,0043 | 1,08 | 0,0751 | 0,0063 | 1,08 | 0,0751 | 0,0099 | 1,59 | 0,0858 | 0,0079 | 1,60 | 0,0858 | 0,0125 |
| S36- | KN St. Michael | St. Stefan ob Leoben | 0,63 | 0,0442 | 0,0023 | 0,64 | 0,0442 | 0,0035 | 0,89 | 0,0619 | 0,0052 | 0,89 | 0,0619 | 0,0082 | 1,31 | 0,0707 | 0,0065 | 1,31 | 0,0707 | 0,0103 |
| S36- | St. Stefan ob Leoben | Kraubath | 0,68 | 0,0475 | 0,0024 | 0,68 | 0,0475 | 0,0038 | 0,96 | 0,0665 | 0,0056 | 0,96 | 0,0665 | 0,0088 | 1,41 | 0,0760 | 0,0070 | 1,41 | 0,0760 | 0,0111 |
| S36- | Kraubath | Feistritz St. Lorenzen | 1,20 | 0,0834 | 0,0043 | 1,20 | 0,0834 | 0,0067 | 1,68 | 0,1167 | 0,0098 | 1,68 | 0,1167 | 0,0154 | 2,47 | 0,1334 | 0,0124 | 2,48 | 0,1334 | 0,0194 |
| S36- | Feistritz St. Lorenzen | Knittelfeld Ost | 1,37 | 0,0957 | 0,0049 | 1,38 | 0,0957 | 0,0077 | 1,93 | 0,1340 | 0,0112 | 1,93 | 0,1340 | 0,0177 | 2,84 | 0,1532 | 0,0142 | 2,85 | 0,1532 | 0,0223 |
| S36- | Knittelfeld Ost | Knittelfeld West | 0,58 | 0,0406 | 0,0021 | 0,58 | 0,0406 | 0,0033 | 0,82 | 0,0568 | 0,0048 | 0,82 | 0,0568 | 0,0075 | 1,20 | 0,0649 | 0,0060 | 1,21 | 0,0649 | 0,0095 |
| S36- | Knittelfeld West | Zeitweg Ost Spielberg | 0,18 | 0,0127 | 0,0006 | 0,18 | 0,0127 | 0,0010 | 0,26 | 0,0177 | 0,0015 | 0,26 | 0,0177 | 0,0023 | 0,38 | 0,0203 | 0,0019 | 0,38 | 0,0203 | 0,0030 |
| S36- | Zeitweg Ost Spielberg | Zeitweg West | 1,18 | 0,0825 | 0,0042 | 1,19 | 0,0825 | 0,0066 | 1,66 | 0,1155 | 0,0097 | 1,67 | 0,1155 | 0,0152 | 2,45 | 0,1320 | 0,0122 | 2,45 | 0,1320 | 0,0192 |
| S36- | Zeitweg West | Judenburg Ost Fohnsdorf | 0,60 | 0,0415 | 0,0021 | 0,60 | 0,0415 | 0,0033 | 0,84 | 0,0581 | 0,0049 | 0,84 | 0,0581 | 0,0077 | 1,23 | 0,0664 | 0,0061 | 1,23 | 0,0664 | 0,0097 |
| S36- | Judenburg Ost Fohnsdorf | Judenburg West | 0,92 | 0,0643 | 0,0033 | 0,93 | 0,0643 | 0,0052 | 1,30 | 0,0901 | 0,0076 | 1,30 | 0,0901 | 0,0119 | 1,91 | 0,1029 | 0,0095 | 1,91 | 0,1029 | 0,0150 |
| S36- | As B317 (prov.) | St. Georgen Ost | 0,10 | 0,0067 | 0,0003 | 0,10 | 0,0067 | 0,0005 | 0,14 | 0,0094 | 0,0008 | 0,14 | 0,0094 | 0,0012 | 0,20 | 0,0108 | 0,0010 | 0,20 | 0,0108 | 0,0016 |
| S36- | St. Georgen Ost | St. Georgen West | 0,18 | 0,0125 | 0,0006 | 0,18 | 0,0125 | 0,0010 | 0,25 | 0,0174 | 0,0015 | 0,25 | 0,0174 | 0,0023 | 0,37 | 0,0199 | 0,0018 | 0,37 | 0,0199 | 0,0029 |
| S37- | St. Veit Nord | St. Veit Mitte / Brückl | 0,56 | 0,0390 | 0,0020 | 0,56 | 0,0390 | 0,0031 | 0,79 | 0,0546 | 0,0046 | 0,79 | 0,0546 | 0,0072 | 1,16 | 0,0624 | 0,0058 | 1,16 | 0,0624 | 0,0091 |
| S37- | St. Veit Mitte / Brückl | St. Veit Süd | 0,48 | 0,0332 | 0,0017 | 0,48 | 0,0332 | 0,0027 | 0,67 | 0,0464 | 0,0039 | 0,67 | 0,0464 | 0,0061 | 0,98 | 0,0531 | 0,0049 | 0,99 | 0,0531 | 0,0077 |
| S37- | St. Veit Süd | St. Veit Industriegebiet | 0,36 | 0,0249 | 0,0013 | 0,36 | 0,0249 | 0,0020 | 0,50 | 0,0349 | 0,0029 | 0,50 | 0,0349 | 0,0046 | 0,74 | 0,0399 | 0,0037 | 0,74 | 0,0399 | 0,0058 |
| S37- | St. Veit Industriegebiet | Maria Saal | 1,26 | 0,0875 | 0,0045 | 1,26 | 0,0875 | 0,0070 | 1,76 | 0,1225 | 0,0103 | 1,77 | 0,1225 | 0,0162 | 2,60 | 0,1400 | 0,0130 | 2,60 | 0,1400 | 0,0204 |
| S37- | Maria Saal | Karnburg | 0,45 | 0,0312 | 0,0016 | 0,45 | 0,0312 | 0,0025 | 0,63 | 0,0437 | 0,0037 | 0,63 | 0,0437 | 0,0058 | 0,93 | 0,0500 | 0,0046 | 0,93 | 0,0500 | 0,0073 |
| S37- | Karnburg | Klagenfurt Nord | 0,39 | 0,0273 | 0,0014 | 0,39 | 0,0273 | 0,0022 | 0,55 | 0,0382 | 0,0032 | 0,55 | 0,0382 | 0,0050 | 0,81 | 0,0436 | 0,0040 | 0,81 | 0,0436 | 0,0064 |
| A01- | Preßbaum | Wien Auhof | 2,74 | 0,1908 | 0,0098 | 2,74 | 0,1908 | 0,0153 | 3,84 | 0,2672 | 0,0224 | 3,86 | 0,2672 | 0,0352 | 5,66 | 0,3053 | 0,0283 | 5,68 | 0,3053 | 0,0444 |
| A01- | KN Steinhäusl | Preßbaum | 1,55 | 0,1078 | 0,0055 | 1,55 | 0,1078 | 0,0087 | 2,17 | 0,1510 | 0,0127 | 2,18 | 0,1510 | 0,0199 | 3,20 | 0,1726 | 0,0160 | 3,21 | 0,1726 | 0,0251 |
| A01- | Alltengbach | KN Steinhäusl | 0,91 | 0,0634 | 0,0032 | 0,91 | 0,0634 | 0,0051 | 1,28 | 0,0888 | 0,0075 | 1,28 | 0,0888 | 0,0117 | 1,88 | 0,1014 | 0,0094 | 1,89 | 0,1014 | 0,0148 |
| A01- | St. Christophen | Alltengbach | 1,09 | 0,0756 | 0,0039 | 1,09 | 0,0756 | 0,0061 | 1,52 | 0,1059 | 0,0089 | 1,53 | 0,1059 | 0,0140 | 2,24 | 0,1210 | 0,0112 | 2,25 | 0,1210 | 0,0176 |
| A01- | Böheimkirchen | St. Christophen | 1,30 | 0,0907 | 0,0046 | 1,30 | 0,0907 | 0,0073 | 1,83 | 0,1270 | 0,0107 | 1,83 | 0,1270 | 0,0167 | 2,69 | 0,1451 | 0,0134 | 2,70 | 0,1451 | 0,0211 |
| A01- | KN St. Pölten | Böheimkirchen | 1,27 | 0,0887 | 0,0045 | 1,28 | 0,0887 | 0,0071 | 1,79 | 0,1242 | 0,0104 | 1,79 | 0,1242 | 0,0164 | 2,63 | 0,1419 | 0,0131</ | | | |

| | | | | | | | | | | | | | | | | | | | | |
|------|----------------------------|----------------------------|------|--------|--------|------|--------|--------|------|--------|--------|--------|--------|--------|------|--------|--------|------|--------|--------|
| A01- | Laakirchen West | Laakirchen Ost | 0,71 | 0,0496 | 0,0025 | 0,71 | 0,0496 | 0,0040 | 1,00 | 0,0694 | 0,0058 | 1,00 | 0,0694 | 0,0092 | 1,47 | 0,0794 | 0,0073 | 1,48 | 0,0794 | 0,0115 |
| A01- | Regau | Laakirchen West | 1,40 | 0,0972 | 0,0050 | 1,40 | 0,0972 | 0,0078 | 1,96 | 0,1361 | 0,0114 | 1,96 | 0,1361 | 0,0180 | 2,89 | 0,1555 | 0,0144 | 2,89 | 0,1555 | 0,0226 |
| A01- | Schörfing | Regau | 1,83 | 0,1277 | 0,0065 | 1,84 | 0,1277 | 0,0103 | 2,57 | 0,1788 | 0,0150 | 2,58 | 0,1788 | 0,0236 | 3,79 | 0,2044 | 0,0189 | 3,80 | 0,2044 | 0,0297 |
| A01- | Seewalchen | Schörfing | 0,28 | 0,0198 | 0,0010 | 0,28 | 0,0198 | 0,0016 | 0,40 | 0,0277 | 0,0023 | 0,40 | 0,0277 | 0,0037 | 0,59 | 0,0317 | 0,0029 | 0,59 | 0,0317 | 0,0046 |
| A01- | St. Georgen | Seewalchen | 1,66 | 0,1158 | 0,0059 | 1,67 | 0,1158 | 0,0093 | 2,33 | 0,1621 | 0,0136 | 2,34 | 0,1621 | 0,0214 | 3,44 | 0,1853 | 0,0172 | 3,45 | 0,1853 | 0,0270 |
| A01- | Oberwang | St. Georgen | 2,22 | 0,1544 | 0,0079 | 2,22 | 0,1544 | 0,0124 | 3,11 | 0,2162 | 0,0181 | 3,12 | 0,2162 | 0,0285 | 4,58 | 0,2470 | 0,0229 | 4,60 | 0,2470 | 0,0360 |
| A01- | Mondsee | Oberwang | 2,04 | 0,1421 | 0,0073 | 2,04 | 0,1421 | 0,0114 | 2,86 | 0,1990 | 0,0167 | 2,87 | 0,1990 | 0,0262 | 4,22 | 0,2274 | 0,0211 | 4,23 | 0,2274 | 0,0331 |
| A01- | Thalgau | Mondsee | 1,88 | 0,1310 | 0,0067 | 1,88 | 0,1310 | 0,0105 | 2,64 | 0,1834 | 0,0154 | 2,65 | 0,1834 | 0,0242 | 3,89 | 0,2096 | 0,0194 | 3,90 | 0,2096 | 0,0305 |
| A01- | Wallersee | Thalgau | 1,43 | 0,0998 | 0,0051 | 1,44 | 0,0998 | 0,0080 | 2,01 | 0,1398 | 0,0117 | 2,02 | 0,1398 | 0,0184 | 2,96 | 0,1597 | 0,0148 | 2,97 | 0,1597 | 0,0232 |
| A01- | Salzburg Nord | Wallersee | 1,39 | 0,0966 | 0,0049 | 1,39 | 0,0966 | 0,0078 | 1,95 | 0,1353 | 0,0114 | 1,95 | 0,1353 | 0,0178 | 2,87 | 0,1546 | 0,0143 | 2,88 | 0,1546 | 0,0225 |
| A01- | Salzburg Bergheim-West | Salzburg Nord | 0,31 | 0,0218 | 0,0011 | 0,31 | 0,0218 | 0,0017 | 0,44 | 0,0305 | 0,0026 | 0,44 | 0,0305 | 0,0040 | 0,65 | 0,0349 | 0,0032 | 0,65 | 0,0349 | 0,0051 |
| A01- | Messe | Salzburg Bergheim-West | 0,15 | 0,0104 | 0,0005 | 0,15 | 0,0104 | 0,0008 | 0,21 | 0,0146 | 0,0012 | 0,21 | 0,0146 | 0,0019 | 0,31 | 0,0167 | 0,0015 | 0,31 | 0,0167 | 0,0024 |
| A01- | Salzburg Mitte Freilassing | Messe | 0,20 | 0,0139 | 0,0007 | 0,20 | 0,0139 | 0,0011 | 0,28 | 0,0194 | 0,0016 | 0,28 | 0,0194 | 0,0026 | 0,41 | 0,0222 | 0,0021 | 0,41 | 0,0222 | 0,0032 |
| A01- | Kleßheim | Salzburg Mitte Freilassing | 0,24 | 0,0170 | 0,0009 | 0,24 | 0,0170 | 0,0014 | 0,34 | 0,0238 | 0,0020 | 0,34 | 0,0238 | 0,0031 | 0,51 | 0,0272 | 0,0025 | 0,51 | 0,0272 | 0,0040 |
| A01- | Siezenheim | Kleßheim | 0,34 | 0,0236 | 0,0012 | 0,34 | 0,0236 | 0,0019 | 0,48 | 0,0330 | 0,0028 | 0,48 | 0,0330 | 0,0044 | 0,70 | 0,0378 | 0,0035 | 0,70 | 0,0378 | 0,0055 |
| A01- | Flughafen | Siezenheim | 0,17 | 0,0119 | 0,0006 | 0,17 | 0,0119 | 0,0010 | 0,24 | 0,0166 | 0,0014 | 0,24 | 0,0166 | 0,0022 | 0,35 | 0,0190 | 0,0018 | 0,35 | 0,0190 | 0,0028 |
| A01- | Wals Salzburg West | Flughafen | 0,21 | 0,0145 | 0,0007 | 0,21 | 0,0145 | 0,0012 | 0,29 | 0,0203 | 0,0017 | 0,29 | 0,0203 | 0,0027 | 0,43 | 0,0232 | 0,0021 | 0,43 | 0,0232 | 0,0034 |
| A01- | KN Salzburg | Wals Salzburg West | 0,31 | 0,0217 | 0,0011 | 0,31 | 0,0217 | 0,0017 | 0,44 | 0,0304 | 0,0026 | 0,44 | 0,0304 | 0,0040 | 0,64 | 0,0347 | 0,0032 | 0,65 | 0,0347 | 0,0051 |
| A01- | Staatsgrenze Walsberg | KN Salzburg | 0,53 | 0,0369 | 0,0019 | 0,53 | 0,0369 | 0,0030 | 0,74 | 0,0517 | 0,0043 | 0,75 | 0,0517 | 0,0068 | 1,09 | 0,0590 | 0,0055 | 1,10 | 0,0590 | 0,0086 |
| A02- | KN Vösendorf | KN Wien Inzersdorf | 0,66 | 0,0462 | 0,0024 | 0,66 | 0,0462 | 0,0037 | 0,93 | 0,0646 | 0,0054 | 0,93 | 0,0646 | 0,0085 | 1,37 | 0,0739 | 0,0068 | 1,37 | 0,0739 | 0,0108 |
| A02- | Mödling | KN Vösendorf | 0,45 | 0,0314 | 0,0016 | 0,45 | 0,0314 | 0,0025 | 0,63 | 0,0439 | 0,0037 | 0,63 | 0,0439 | 0,0058 | 0,93 | 0,0502 | 0,0047 | 0,93 | 0,0502 | 0,0073 |
| A02- | Wr. Neudorf | Mödling | 0,43 | 0,0299 | 0,0015 | 0,43 | 0,0299 | 0,0024 | 0,60 | 0,0419 | 0,0035 | 0,61 | 0,0419 | 0,0055 | 0,89 | 0,0479 | 0,0044 | 0,89 | 0,0479 | 0,0070 |
| A02- | Wr. Neudorf IZ/Süd | Wr. Neudorf | 0,47 | 0,0329 | 0,0017 | 0,47 | 0,0329 | 0,0026 | 0,66 | 0,0461 | 0,0039 | 0,67 | 0,0461 | 0,0061 | 0,98 | 0,0527 | 0,0049 | 0,98 | 0,0527 | 0,0077 |
| A02- | KN Guntramsdorf | Wr. Neudorf IZ/Süd | 0,69 | 0,0480 | 0,0025 | 0,69 | 0,0480 | 0,0039 | 0,97 | 0,0672 | 0,0056 | 0,97 | 0,0672 | 0,0089 | 1,43 | 0,0769 | 0,0071 | 1,43 | 0,0769 | 0,0112 |
| A02- | Traiskirchen | KN Guntramsdorf | 0,77 | 0,0535 | 0,0027 | 0,77 | 0,0535 | 0,0043 | 1,08 | 0,0749 | 0,0063 | 1,08 | 0,0749 | 0,0099 | 1,59 | 0,0856 | 0,0079 | 1,59 | 0,0856 | 0,0125 |
| A02- | Baden | Traiskirchen | 0,43 | 0,0298 | 0,0015 | 0,43 | 0,0298 | 0,0024 | 0,60 | 0,0417 | 0,0035 | 0,60 | 0,0417 | 0,0055 | 0,88 | 0,0476 | 0,0044 | 0,89 | 0,0476 | 0,0069 |
| A02- | Bad Vöslau | Baden | 0,70 | 0,0489 | 0,0025 | 0,70 | 0,0489 | 0,0039 | 0,98 | 0,0685 | 0,0057 | 0,99 | 0,0685 | 0,0090 | 1,45 | 0,0783 | 0,0072 | 1,46 | 0,0783 | 0,0114 |
| A02- | Kottingbrunn | Bad Vöslau | 0,51 | 0,0353 | 0,0018 | 0,51 | 0,0353 | 0,0028 | 0,71 | 0,0494 | 0,0042 | 0,71 | 0,0494 | 0,0065 | 1,05 | 0,0565 | 0,0052 | 1,05 | 0,0565 | 0,0082 |
| A02- | Leobersdorf | Kottingbrunn | 0,44 | 0,0310 | 0,0016 | 0,45 | 0,0310 | 0,0025 | 0,62 | 0,0434 | 0,0036 | 0,63 | 0,0434 | 0,0057 | 0,92 | 0,0496 | 0,0046 | 0,92 | 0,0496 | 0,0072 |
| A02- | Wöllersdorf | Leobersdorf | 1,77 | 0,1236 | 0,0063 | 1,78 | 0,1236 | 0,0099 | 2,49 | 0,1731 | 0,0145 | 2,50 | 0,1731 | 0,0228 | 3,67 | 0,1978 | 0,0183 | 3,68 | 0,1978 | 0,0288 |
| A02- | Wr. Neustadt West | Wöllersdorf | 1,15 | 0,0803 | 0,0041 | 1,15 | 0,0803 | 0,0064 | 1,62 | 0,1124 | 0,0094 | 1,62 | 0,1124 | 0,0148 | 2,38 | 0,1285 | 0,0119 | 2,39 | 0,1285 | 0,0187 |
| A02- | KN Wr. Neustadt | Wr. Neustadt West | 0,46 | 0,0322 | 0,0016 | 0,46 | 0,0322 | 0,0026 | 0,65 | 0,0450 | 0,0038 | 0,65 | 0,0450 | 0,0059 | 0,95 | 0,0514 | 0,0048 | 0,96 | 0,0514 | 0,0075 |
| A02- | KN Seebenstein | KN Wr. Neustadt | 2,09 | 0,1455 | 0,0074 | 2,09 | 0,1455 | 0,0117 | 2,93 | 0,2037 | 0,0171 | 2,94 | 0,2037 | 0,0269 | 4,32 | 0,2328 | 0,0216 | 4,33 | 0,2328 | 0,0339 |
| A02- | Grimmenstein | KN Seebenstein | 1,78 | 0,1241 | 0,0063 | 1,78 | 0,1241 | 0,0100 | 2,50 | 0,1738 | 0,0146 | 2,51 | 0,1738 | 0,0229 | 3,68 | 0,1986 | 0,0184 | 3,69 | 0,1986 | 0,0289 |
| A02- | Edlitz | Grimmenstein | 0,49 | 0,0344 | 0,0018 | 0,49 | 0,0344 | 0,0028 | 0,69 | 0,0481 | 0,0040 | 0,69 | 0,0481 | 0,0063 | 1,02 | 0,0550 | 0,0051 | 1,02 | 0,0550 | 0,0080 |
| A02- | Krumbach | Edlitz | 1,52 | 0,1061 | 0,0054 | 1,53 | 0,1061 | 0,0085 | 2,14 | 0,1485 | 0,0125 | 2,14 | 0,1485 | 0,0196 | 3,15 | 0,1698 | 0,0157 | 3,16 | 0,1698 | 0,0247 |
| A02- | Zöbern | Krumbach | 0,80 | 0,0560 | 0,0029 | 0,81 | 0,0560 | 0,0045 | 1,13 | 0,0784 | 0,0066 | 1,13 | 0,0784 | 0,0103 | 1,66 | 0,0896 | 0,0083 | 1,67 | 0,0896 | 0,0130 |
| A02- | Aspang | Zöbern | 0,11 | 0,0073 | 0,0004 | 0,11 | 0,0073 | 0,0006 | 0,15 | 0,0102 | 0,0009 | 0,15 | 0,0102 | 0,0014 | 0,22 | 0,0117 | 0,0011 | 0,22 | 0,0117 | 0,0017 |
| A02- | Schäffern | Aspang | 1,27 | 0,0886 | 0,0045 | 1,27 | 0,0886 | 0,0071 | 1,78 | 0,1241 | 0,0104 | 1,79 | 0,1241 | 0,0164 | 2,63 | 0,1418 | 0,0131 | 2,64 | 0,1418 | 0,0206 |
| A02- | Pinggau/Friedberg | Schäffern | 1,52 | 0,1059 | 0,0054 | 1,52 | 0,1059 | 0,0085 | 2,13 | 0,1482 | 0,0124 | 2,14 | 0,1482 | 0,0195 | 3,14 | 0,1694 | 0,0157 | 3,15 | 0,1694 | 0,0246 |
| A02- | Pinkafeld | Pinggau/Friedberg | 1,03 | 0,0717 | 0,0037 | 1,03 | 0,0717 | 0,0058 | 1,44 | 0,1004 | 0,0084 | 1,45 | 0,1004 | 0,0132 | 2,13 | 0,1147 | 0,0106 | 2,13 | 0,1147 | 0,0167 |
| A02- | Lafnitzal/Oberwart | Pinkafeld | 2,15 | 0,1495 | 0,0076 | 2,15 | 0,1495 | 0,0120 | 3,01 | 0,2093 | 0,0176 | 3,02 | 0,2093 | 0,0276 | 4,44 | 0,2392 | 0,0221 | 4,45 | 0,2392 | 0,0348 |
| A02- | Hartberg | Lafnitzal/Oberwart | 0,85 | 0,0590 | 0,0030 | 0,85 | 0,0590 | 0,0047 | 1,19 | 0,0826 | 0,0069 | 1,19 | 0,0826 | 0,0109 | 1,75 | 0,0944 | 0,0087 | 1,76 | 0,0944 | 0,0137 |
| A02- | Sebersdorf/Bad Waltersdorf | Hartberg | 2,14 | 0,1493 | 0,0076 | 2,15 | 0,1493 | 0,0120 | 3,01 | 0,2090 | 0,0175 | 3,02 | 0,2090 | 0,0276 | 4,43 | 0,2389 | 0,0221 | 4,44 | 0,2389 | 0,0348 |
| A02- | Ilz Fürstenfeld | Sebersdorf/Bad Waltersdorf | 2,40 | 0,1674 | 0,0086 | 2,41 | 0,1674 | 0,0134 | 3,37 | 0,2344 | 0,0197 | 3,38 | 0,2344 | 0,0309 | 4,97 | 0,2678 | 0,0248 | 4,98 | 0,2678 | 0,0390 |
| A02- | Sinabelkirchen | Ilz Fürstenfeld | 2,21 | 0,1539 | 0,0079 | 2,21 | 0,1539 | 0,0124 | 3,10 | 0,2154 | 0,0181 | 3,11 | 0,2154 | 0,0284 | 4,57 | 0,2462 | 0,0228 | 4,58 | 0,2462 | 0,0358 |
| A02- | Gleisdorf Süd | Sinabelkirchen | 1,45 | 0,1014 | 0,0052 | 1,46 | 0,1014 | 0,0081 | 2,04 | 0,1419 | 0,0119 | 2,05 | 0,1419 | 0,0187 | 3,01 | 0,1622 | 0,0150 | 3,02 | 0,1622 | 0,0236 |
| A02- | Gleisdorf West | Gleisdorf Süd | 0,63 | 0,0440 | 0,0022 | 0,63 | 0,0440 | 0,0035 | 0,89 | 0,0616 | 0,0052 | 0,89 | 0,0616 | 0,0081 | 1,31 | 0,0704 | 0,0065 | 1,31 | 0,0704 | 0,0102 |
| A02- | Laßnitzhöhe | Gleisdorf West | 1,65 | 0,1153 | 0,0059 | 1,66 | 0,1153 | 0,0093 | 2,32 | 0,1614 | 0,0135 | 2,33 | 0,1614 | 0,0213 | 3,42 | 0,1845 | 0,0171 | 3,43 | 0,1845 | 0,0268 |
| A02- | KN Graz Ost | Laßnitzhöhe | 2,07 | 0,1442 | 0,0074 | 2,07 | 0,1442 | 0,0116 | 2,90 | 0,2019 | 0,0170 | 2,91 | 0,2019 | 0,0266 | 4,28 | 0,2308 | 0,0214 | 4,29 | 0,2308 | 0,0336 |
| A02- | Graz Feldkirchen Flughafen | KN Graz Ost | 0,74 | 0,0519 | 0,0027 | 0,75 | 0,0519 | 0,0042 | 1,05 | 0,0727 | 0,0061 | 1,05 | 0,0727 | 0,0096 | 1,54 | 0,0830 | 0,0077 | 1,54 | 0,0830 | 0,0121 |
| A02- | KN Graz West | Graz Feldkirchen Flughafen | 0,50 | 0,0347 | 0,0018 | 0,50 | 0,0347 | 0,0028 | 0,70 | 0,0486 | 0,0041 | 0,70 | 0,0486 | 0,0064 | 1,03 | 0,0556 | 0,0051 | 1,03 | 0,0556 | 0,0081 |
| A02- | Unterprenstatten | KN Graz West | 0,60 | 0,0418 | 0,0021 | 0,60 | 0,0418 | 0,0034 | 0,84 | 0,0585 | 0,0049 | 0,84 | 0,0585 | 0,0077 | 1,24 | 0,0668 | 0,0062 | 1,24 | 0,0668 | 0,0097 |
| A02- | Lieboch | Unterprenstatten | 0,93 | 0,0649 | 0,0033 | 0,93 | 0,0649 | 0,0052 | 1,31 | 0,0908 | 0,0076 | 1,31 | 0,0908 | 0,0120 | 1,93 | 0,1038 | 0,0096 | 1,93 | 0,1038 | 0,0151 |
| A02- | Mooskirchen | Lieboch | 1,28 | 0,0894 | 0,0046 | 1,29 | 0,0894 | 0,0072 | 1,80 | 0,1252 | 0,0105 | 1,81 | 0,1252 | 0,0165 | 2,65 | 0,1431 | 0,0133 | 2,66 | 0,1431 | 0,0208 |
| A02- | Steinberg | Mooskirchen | 1,33 | 0,0926 | 0,0047 | 1,33 | 0,0926 | 0,0074 | 1,86 | 0,1296 | 0,0109 | 1,87 | 0,1296 | 0,0171 | 2,75 | 0,1481 | 0,0137 | 2,76 | 0,1481 | 0,0216 |
| A02- | Modriach | Steinberg | 3,32 | 0,2314 | 0,0118 | 3,33 | 0,2314 | 0,0186 | 4,66 | 0,3240 | 0,0272 | 4,68</ | | | | | | | | |

| | | | | | | | | | | | | | | | | | | | | |
|------|----------------------------------|----------------------------------|------|--------|--------|------|--------|--------|------|--------|--------|------|--------|--------|------|--------|--------|------|--------|--------|
| A02- | Velden West | Velden Ost | 0,73 | 0,0511 | 0,0026 | 0,74 | 0,0511 | 0,0041 | 1,03 | 0,0716 | 0,0060 | 1,03 | 0,0716 | 0,0094 | 1,52 | 0,0818 | 0,0076 | 1,52 | 0,0818 | 0,0119 |
| A02- | Wernberg | Velden West | 1,21 | 0,0845 | 0,0043 | 1,22 | 0,0845 | 0,0068 | 1,70 | 0,1183 | 0,0099 | 1,71 | 0,1183 | 0,0156 | 2,51 | 0,1352 | 0,0125 | 2,52 | 0,1352 | 0,0197 |
| A02- | KN Villach | Wernberg | 0,64 | 0,0449 | 0,0023 | 0,65 | 0,0449 | 0,0036 | 0,90 | 0,0629 | 0,0053 | 0,91 | 0,0629 | 0,0083 | 1,33 | 0,0719 | 0,0067 | 1,34 | 0,0719 | 0,0105 |
| A02- | Villach Faaker See | KN Villach | 0,50 | 0,0349 | 0,0018 | 0,50 | 0,0349 | 0,0028 | 0,70 | 0,0489 | 0,0041 | 0,71 | 0,0489 | 0,0065 | 1,04 | 0,0559 | 0,0052 | 1,04 | 0,0559 | 0,0081 |
| A02- | Villach Warmbad | Villach Faaker See | 1,15 | 0,0798 | 0,0041 | 1,15 | 0,0798 | 0,0064 | 1,61 | 0,1117 | 0,0094 | 1,61 | 0,1117 | 0,0147 | 2,37 | 0,1277 | 0,0118 | 2,38 | 0,1277 | 0,0186 |
| A02- | Hermagor | Villach Warmbad | 2,08 | 0,1447 | 0,0074 | 2,08 | 0,1447 | 0,0116 | 2,91 | 0,2025 | 0,0170 | 2,92 | 0,2025 | 0,0267 | 4,29 | 0,2315 | 0,0214 | 4,31 | 0,2315 | 0,0337 |
| A02- | Arnoldstein | Hermagor | 0,49 | 0,0345 | 0,0018 | 0,50 | 0,0345 | 0,0028 | 0,69 | 0,0482 | 0,0040 | 0,70 | 0,0482 | 0,0064 | 1,02 | 0,0551 | 0,0051 | 1,03 | 0,0551 | 0,0080 |
| A02- | Staatsgrenze Arnoldstein | Arnoldstein | 0,76 | 0,0528 | 0,0027 | 0,76 | 0,0528 | 0,0042 | 1,06 | 0,0740 | 0,0062 | 1,07 | 0,0740 | 0,0098 | 1,57 | 0,0845 | 0,0078 | 1,57 | 0,0845 | 0,0123 |
| A03- | Münchendorf/Achau | KN Guntramsdorf | 0,20 | 0,0137 | 0,0007 | 0,20 | 0,0137 | 0,0011 | 0,28 | 0,0192 | 0,0016 | 0,28 | 0,0192 | 0,0025 | 0,41 | 0,0219 | 0,0020 | 0,41 | 0,0219 | 0,0032 |
| A03- | Ebreichsdorf Nord | Münchendorf/Achau | 0,83 | 0,0577 | 0,0029 | 0,83 | 0,0577 | 0,0046 | 1,16 | 0,0808 | 0,0068 | 1,17 | 0,0808 | 0,0107 | 1,71 | 0,0924 | 0,0086 | 1,72 | 0,0924 | 0,0134 |
| A03- | Ebreichsdorf West | Ebreichsdorf Nord | 0,68 | 0,0471 | 0,0024 | 0,68 | 0,0471 | 0,0038 | 0,95 | 0,0660 | 0,0055 | 0,95 | 0,0660 | 0,0087 | 1,40 | 0,0754 | 0,0070 | 1,40 | 0,0754 | 0,0110 |
| A03- | Pottendorf | Ebreichsdorf West | 0,89 | 0,0618 | 0,0032 | 0,89 | 0,0618 | 0,0050 | 1,25 | 0,0866 | 0,0073 | 1,25 | 0,0866 | 0,0114 | 1,83 | 0,0989 | 0,0092 | 1,84 | 0,0989 | 0,0144 |
| A03- | Hornstein | Pottendorf | 1,46 | 0,1015 | 0,0052 | 1,46 | 0,1015 | 0,0082 | 2,04 | 0,1421 | 0,0119 | 2,05 | 0,1421 | 0,0187 | 3,01 | 0,1624 | 0,0150 | 3,02 | 0,1624 | 0,0236 |
| A03- | Müllendorf | Hornstein | 0,95 | 0,0665 | 0,0034 | 0,96 | 0,0665 | 0,0053 | 1,34 | 0,0931 | 0,0078 | 1,34 | 0,0931 | 0,0123 | 1,97 | 0,1064 | 0,0099 | 1,98 | 0,1064 | 0,0155 |
| A03- | KN Eisenstadt | Müllendorf | 0,80 | 0,0556 | 0,0028 | 0,80 | 0,0556 | 0,0045 | 1,12 | 0,0779 | 0,0065 | 1,12 | 0,0779 | 0,0103 | 1,65 | 0,0890 | 0,0082 | 1,66 | 0,0890 | 0,0129 |
| A031 | Siegendorf | KN Eisenstadt | 0,63 | 0,0438 | 0,0022 | 0,63 | 0,0438 | 0,0035 | 0,88 | 0,0614 | 0,0052 | 0,89 | 0,0614 | 0,0081 | 1,30 | 0,0701 | 0,0065 | 1,30 | 0,0701 | 0,0102 |
| A041 | KN Wien Prater | Stadionbrücke | 0,12 | 0,0081 | 0,0004 | 0,12 | 0,0081 | 0,0006 | 0,16 | 0,0113 | 0,0009 | 0,16 | 0,0113 | 0,0015 | 0,24 | 0,0129 | 0,0012 | 0,24 | 0,0129 | 0,0019 |
| A04- | Wien Simmeringer Haide | KN Wien Prater | 0,80 | 0,0556 | 0,0028 | 0,80 | 0,0556 | 0,0045 | 1,12 | 0,0778 | 0,0065 | 1,12 | 0,0778 | 0,0103 | 1,65 | 0,0889 | 0,0082 | 1,65 | 0,0889 | 0,0129 |
| A04- | KN Schwechat | Wien Simmeringer Haide | 0,72 | 0,0499 | 0,0025 | 0,72 | 0,0499 | 0,0040 | 1,00 | 0,0698 | 0,0059 | 1,01 | 0,0698 | 0,0092 | 1,48 | 0,0798 | 0,0074 | 1,48 | 0,0798 | 0,0116 |
| A04- | Flughafen Wien Schwechat | KN Schwechat | 1,03 | 0,0720 | 0,0037 | 1,04 | 0,0720 | 0,0058 | 1,45 | 0,1008 | 0,0085 | 1,46 | 0,1008 | 0,0133 | 2,14 | 0,1153 | 0,0107 | 2,14 | 0,1153 | 0,0168 |
| A04- | Fischamend | Flughafen Wien Schwechat | 1,16 | 0,0807 | 0,0041 | 1,16 | 0,0807 | 0,0065 | 1,62 | 0,1129 | 0,0095 | 1,63 | 0,1129 | 0,0149 | 2,39 | 0,1290 | 0,0120 | 2,40 | 0,1290 | 0,0188 |
| A04- | Bruck/Leitha West | Fischamend | 2,54 | 0,1769 | 0,0090 | 2,54 | 0,1769 | 0,0142 | 3,56 | 0,2476 | 0,0208 | 3,57 | 0,2476 | 0,0327 | 5,25 | 0,2830 | 0,0262 | 5,26 | 0,2830 | 0,0412 |
| A04- | Bruck/Leitha Ost | Bruck/Leitha West | 0,84 | 0,0587 | 0,0030 | 0,84 | 0,0587 | 0,0047 | 1,18 | 0,0822 | 0,0069 | 1,19 | 0,0822 | 0,0108 | 1,74 | 0,0940 | 0,0087 | 1,75 | 0,0940 | 0,0137 |
| A04- | KN Bruckneudorf | Bruck/Leitha Ost | 0,53 | 0,0366 | 0,0019 | 0,53 | 0,0366 | 0,0029 | 0,74 | 0,0513 | 0,0043 | 0,74 | 0,0513 | 0,0068 | 1,09 | 0,0586 | 0,0054 | 1,09 | 0,0586 | 0,0085 |
| A04- | Parndorf | KN Bruckneudorf | 0,34 | 0,0236 | 0,0012 | 0,34 | 0,0236 | 0,0019 | 0,48 | 0,0330 | 0,0028 | 0,48 | 0,0330 | 0,0044 | 0,70 | 0,0377 | 0,0035 | 0,70 | 0,0377 | 0,0055 |
| A04- | Neusiedl | Parndorf | 0,65 | 0,0456 | 0,0023 | 0,66 | 0,0456 | 0,0037 | 0,92 | 0,0639 | 0,0054 | 0,92 | 0,0639 | 0,0084 | 1,35 | 0,0730 | 0,0068 | 1,36 | 0,0730 | 0,0106 |
| A04- | Neusiedl/Gewerbepark | Neusiedl | 0,15 | 0,0106 | 0,0005 | 0,15 | 0,0106 | 0,0008 | 0,21 | 0,0148 | 0,0012 | 0,21 | 0,0148 | 0,0020 | 0,31 | 0,0169 | 0,0016 | 0,31 | 0,0169 | 0,0025 |
| A04- | Weiden/Gols | Neusiedl/Gewerbepark | 1,36 | 0,0946 | 0,0048 | 1,36 | 0,0946 | 0,0076 | 1,91 | 0,1325 | 0,0111 | 1,91 | 0,1325 | 0,0175 | 2,81 | 0,1514 | 0,0140 | 2,82 | 0,1514 | 0,0220 |
| A04- | Mönchhof | Weiden/Gols | 0,99 | 0,0690 | 0,0035 | 0,99 | 0,0690 | 0,0055 | 1,39 | 0,0966 | 0,0081 | 1,39 | 0,0966 | 0,0127 | 2,05 | 0,1104 | 0,0102 | 2,05 | 0,1104 | 0,0161 |
| A04- | Nickelsdorf | Mönchhof | 1,55 | 0,1081 | 0,0055 | 1,55 | 0,1081 | 0,0087 | 2,18 | 0,1514 | 0,0127 | 2,18 | 0,1514 | 0,0200 | 3,21 | 0,1730 | 0,0160 | 3,22 | 0,1730 | 0,0252 |
| A04- | Staatsgrenze Nickelsdorf | Nickelsdorf | 0,27 | 0,0192 | 0,0010 | 0,28 | 0,0192 | 0,0015 | 0,39 | 0,0268 | 0,0023 | 0,39 | 0,0268 | 0,0035 | 0,57 | 0,0306 | 0,0028 | 0,57 | 0,0306 | 0,0045 |
| A05- | Wolkersdorf Süd | KN Eibesbrunn | 0,54 | 0,0373 | 0,0019 | 0,54 | 0,0373 | 0,0030 | 0,75 | 0,0522 | 0,0044 | 0,75 | 0,0522 | 0,0069 | 1,11 | 0,0596 | 0,0055 | 1,11 | 0,0596 | 0,0087 |
| A05- | Ulrichskirchen | Wolkersdorf Süd | 0,58 | 0,0403 | 0,0021 | 0,58 | 0,0403 | 0,0032 | 0,81 | 0,0564 | 0,0047 | 0,81 | 0,0564 | 0,0074 | 1,20 | 0,0645 | 0,0060 | 1,20 | 0,0645 | 0,0094 |
| A05- | Wolkersdorf Nord | Ulrichskirchen | 0,38 | 0,0263 | 0,0013 | 0,38 | 0,0263 | 0,0021 | 0,53 | 0,0369 | 0,0031 | 0,53 | 0,0369 | 0,0049 | 0,78 | 0,0422 | 0,0039 | 0,78 | 0,0422 | 0,0061 |
| A05- | Hochleithen | Wolkersdorf Nord | 0,68 | 0,0473 | 0,0024 | 0,68 | 0,0473 | 0,0038 | 0,95 | 0,0662 | 0,0056 | 0,95 | 0,0662 | 0,0087 | 1,40 | 0,0756 | 0,0070 | 1,41 | 0,0756 | 0,0110 |
| A05- | Gaweinstal Mitte | Hochleithen | 1,36 | 0,0946 | 0,0048 | 1,36 | 0,0946 | 0,0076 | 1,90 | 0,1324 | 0,0111 | 1,91 | 0,1324 | 0,0175 | 2,81 | 0,1513 | 0,0140 | 2,81 | 0,1513 | 0,0220 |
| A05- | Gaweinstal Nord | Gaweinstal Mitte | 0,36 | 0,0250 | 0,0013 | 0,36 | 0,0250 | 0,0020 | 0,50 | 0,0350 | 0,0029 | 0,51 | 0,0350 | 0,0046 | 0,74 | 0,0400 | 0,0037 | 0,74 | 0,0400 | 0,0058 |
| A05- | Mistelbach Süd | Gaweinstal Nord | 0,62 | 0,0432 | 0,0022 | 0,62 | 0,0432 | 0,0035 | 0,87 | 0,0605 | 0,0051 | 0,87 | 0,0605 | 0,0080 | 1,28 | 0,0691 | 0,0064 | 1,29 | 0,0691 | 0,0101 |
| A05- | Mistelbach Ost / Wilfersdorf | Mistelbach Süd | 1,04 | 0,0725 | 0,0037 | 1,04 | 0,0725 | 0,0058 | 1,46 | 0,1015 | 0,0085 | 1,46 | 0,1015 | 0,0134 | 2,15 | 0,1160 | 0,0107 | 2,16 | 0,1160 | 0,0169 |
| A05- | Poysdorf Süd | Mistelbach Ost / Wilfersdorf | 1,05 | 0,0732 | 0,0037 | 1,05 | 0,0732 | 0,0059 | 1,47 | 0,1025 | 0,0086 | 1,48 | 0,1025 | 0,0135 | 2,17 | 0,1171 | 0,0108 | 2,18 | 0,1171 | 0,0170 |
| A05- | Großkrut | Poysdorf Süd | 1,39 | 0,0965 | 0,0049 | 1,39 | 0,0965 | 0,0077 | 1,94 | 0,1351 | 0,0113 | 1,95 | 0,1351 | 0,0178 | 2,86 | 0,1544 | 0,0143 | 2,87 | 0,1544 | 0,0225 |
| A05- | Poysdorf Nord | Großkrut | 1,35 | 0,0939 | 0,0048 | 1,35 | 0,0939 | 0,0075 | 1,89 | 0,1314 | 0,0110 | 1,90 | 0,1314 | 0,0173 | 2,79 | 0,1502 | 0,0139 | 2,79 | 0,1502 | 0,0219 |
| A06- | Potzneusiedl | KN Bruckneudorf | 1,71 | 0,1189 | 0,0061 | 1,71 | 0,1189 | 0,0095 | 2,39 | 0,1665 | 0,0140 | 2,40 | 0,1665 | 0,0220 | 3,53 | 0,1903 | 0,0176 | 3,54 | 0,1903 | 0,0277 |
| A06- | Gattendorf | Potzneusiedl | 0,74 | 0,0516 | 0,0026 | 0,74 | 0,0516 | 0,0041 | 1,04 | 0,0723 | 0,0061 | 1,04 | 0,0723 | 0,0095 | 1,53 | 0,0826 | 0,0076 | 1,54 | 0,0826 | 0,0120 |
| A06- | Kittsee | Gattendorf | 1,24 | 0,0863 | 0,0044 | 1,24 | 0,0863 | 0,0069 | 1,74 | 0,1209 | 0,0101 | 1,74 | 0,1209 | 0,0159 | 2,56 | 0,1381 | 0,0128 | 2,57 | 0,1381 | 0,0201 |
| A06- | Staatsgrenze Kittsee | Kittsee | 0,63 | 0,0439 | 0,0022 | 0,63 | 0,0439 | 0,0035 | 0,88 | 0,0614 | 0,0052 | 0,89 | 0,0614 | 0,0081 | 1,30 | 0,0702 | 0,0065 | 1,31 | 0,0702 | 0,0102 |
| A07- | Linz Franzosenhausweg | KN Linz | 0,44 | 0,0309 | 0,0016 | 0,44 | 0,0309 | 0,0025 | 0,62 | 0,0433 | 0,0036 | 0,63 | 0,0433 | 0,0057 | 0,92 | 0,0495 | 0,0046 | 0,92 | 0,0495 | 0,0072 |
| A07- | Linz Salzburger Straße Neue Welt | Linz Franzosenhausweg | 0,39 | 0,0270 | 0,0014 | 0,39 | 0,0270 | 0,0022 | 0,54 | 0,0378 | 0,0032 | 0,55 | 0,0378 | 0,0050 | 0,80 | 0,0432 | 0,0040 | 0,80 | 0,0432 | 0,0063 |
| A07- | Muldenstraße Bindermichl | Linz Salzburger Straße Neue Welt | 0,27 | 0,0187 | 0,0010 | 0,27 | 0,0187 | 0,0015 | 0,38 | 0,0262 | 0,0022 | 0,38 | 0,0262 | 0,0035 | 0,56 | 0,0300 | 0,0028 | 0,56 | 0,0300 | 0,0044 |
| A07- | Leonding Linz Zentrum | Muldenstraße Bindermichl | 0,13 | 0,0091 | 0,0005 | 0,13 | 0,0091 | 0,0007 | 0,18 | 0,0127 | 0,0011 | 0,18 | 0,0127 | 0,0017 | 0,27 | 0,0146 | 0,0013 | 0,27 | 0,0146 | 0,0021 |
| A07- | Linz Wiener Straße | Leonding Linz Zentrum | 0,18 | 0,0128 | 0,0007 | 0,18 | 0,0128 | 0,0010 | 0,26 | 0,0179 | 0,0015 | 0,26 | 0,0179 | 0,0024 | 0,38 | 0,0205 | 0,0019 | 0,38 | 0,0205 | 0,0030 |
| A07- | Linz VOEST | Linz Wiener Straße | 0,17 | 0,0119 | 0,0006 | 0,17 | 0,0119 | 0,0010 | 0,24 | 0,0166 | 0,0014 | 0,24 | 0,0166 | 0,0022 | 0,35 | 0,0190 | 0,0018 | 0,35 | 0,0190 | 0,0028 |
| A07- | Linz Industriezeile | Linz VOEST | 0,13 | 0,0093 | 0,0005 | 0,13 | 0,0093 | 0,0007 | 0,19 | 0,0131 | 0,0011 | 0,19 | 0,0131 | 0,0017 | 0,28 | 0,0149 | 0,0014 | 0,28 | 0,0149 | 0,0022 |
| A07- | Linz Prinz Eugenstraße | Linz Industriezeile | 0,21 | 0,0148 | 0,0008 | 0,21 | 0,0148 | 0,0012 | 0,30 | 0,0207 | 0,0017 | 0,30 | 0,0207 | 0,0027 | 0,44 | 0,0237 | 0,0022 | 0,44 | 0,0237 | 0,0034 |
| A07- | Linz Hafensstraße | Linz Prinz Eugenstraße | 0,40 | 0,0277 | 0,0014 | 0,40 | 0,0277 | 0,0022 | 0,56 | 0,0388 | 0,0033 | 0,56 | 0,0388 | 0,0051 | 0,82 | 0,0443 | 0,0041 | 0,82 | 0,0443 | 0,0065 |
| A07- | Linz Urfahr | Linz Hafensstraße | 0,16 | 0,0109 | 0,0006 | 0,16 | 0,0109 | 0,0009 | 0,22 | 0,0152 | 0,0013 | 0,22 | 0,0152 | 0,0020 | 0,32 | 0,0174 | 0,0016 | 0,32 | 0,0174 | 0,0025 |
| A07- | Linz Dornach | Linz Urfahr | 0,38 | 0,0264 | 0,0013 | 0,38 | 0,0264 | | | | | | | | | | | | | |

| | | | | | | | | | | | | | | | | | | | | |
|------|---|--------------------------------------|-------|--------|--------|-------|--------|--------|-------|--------|--------|-------|--------|--------|-------|--------|--------|-------|--------|--------|
| A08- | Staatsgrenze Suben | Schärding Suben | 0,44 | 0,0306 | 0,0016 | 0,44 | 0,0306 | 0,0025 | 0,62 | 0,0428 | 0,0036 | 0,62 | 0,0428 | 0,0056 | 0,91 | 0,0489 | 0,0045 | 0,91 | 0,0489 | 0,0071 |
| A09- | Ried im Traunkreis | KN Voralpenkreuz | 1,08 | 0,0754 | 0,0039 | 1,08 | 0,0754 | 0,0061 | 1,52 | 0,1055 | 0,0089 | 1,52 | 0,1055 | 0,0139 | 2,24 | 0,1206 | 0,0112 | 2,24 | 0,1206 | 0,0175 |
| A09- | Inzersdorf Kirchdorf | Ried im Traunkreis | 2,03 | 0,1414 | 0,0072 | 2,03 | 0,1414 | 0,0114 | 2,85 | 0,1979 | 0,0166 | 2,86 | 0,1979 | 0,0261 | 4,20 | 0,2262 | 0,0209 | 4,21 | 0,2262 | 0,0329 |
| A09- | Klaus | Inzersdorf Kirchdorf | 2,47 | 0,1722 | 0,0088 | 2,48 | 0,1722 | 0,0138 | 3,47 | 0,2411 | 0,0202 | 3,48 | 0,2411 | 0,0318 | 5,11 | 0,2755 | 0,0255 | 5,13 | 0,2755 | 0,0401 |
| A09- | St. Pankratz | Klaus | 1,57 | 0,1095 | 0,0056 | 1,57 | 0,1095 | 0,0088 | 2,20 | 0,1532 | 0,0129 | 2,21 | 0,1532 | 0,0202 | 3,25 | 0,1751 | 0,0162 | 3,26 | 0,1751 | 0,0255 |
| A09- | Roßleiten Windischgarsten | St. Pankratz | 2,19 | 0,1527 | 0,0078 | 2,20 | 0,1527 | 0,0123 | 3,08 | 0,2138 | 0,0179 | 3,09 | 0,2138 | 0,0282 | 4,53 | 0,2444 | 0,0226 | 4,55 | 0,2444 | 0,0356 |
| A09- | Gleinkerau | Roßleiten Windischgarsten | 1,03 | 0,0718 | 0,0037 | 1,03 | 0,0718 | 0,0058 | 1,45 | 0,1005 | 0,0084 | 1,45 | 0,1005 | 0,0133 | 2,13 | 0,1149 | 0,0106 | 2,14 | 0,1149 | 0,0167 |
| A09- | Spital am Pyhrn | Gleinkerau | 0,78 | 0,0541 | 0,0028 | 0,78 | 0,0541 | 0,0043 | 1,09 | 0,0758 | 0,0064 | 1,09 | 0,0758 | 0,0100 | 1,61 | 0,0866 | 0,0080 | 1,61 | 0,0866 | 0,0126 |
| A09- | Ardning / Admont | Spital am Pyhrn | 4,27 | 0,1378 | 0,0070 | 4,27 | 0,1378 | 0,0111 | 5,98 | 0,1929 | 0,0162 | 5,99 | 0,1929 | 0,0254 | 8,90 | 0,2204 | 0,0204 | 8,91 | 0,2204 | 0,0321 |
| A09- | Liezen | Ardning / Admont | 0,45 | 0,0314 | 0,0016 | 0,45 | 0,0314 | 0,0025 | 0,63 | 0,0440 | 0,0037 | 0,63 | 0,0440 | 0,0058 | 0,93 | 0,0502 | 0,0047 | 0,93 | 0,0502 | 0,0073 |
| A09- | Rottenmann | Liezen | 0,94 | 0,0656 | 0,0034 | 0,94 | 0,0656 | 0,0053 | 1,32 | 0,0919 | 0,0077 | 1,33 | 0,0919 | 0,0121 | 1,95 | 0,1050 | 0,0097 | 1,95 | 0,1050 | 0,0153 |
| A09- | Trieben | Rottenmann | 2,35 | 0,1636 | 0,0084 | 2,35 | 0,1636 | 0,0131 | 3,29 | 0,2290 | 0,0192 | 3,30 | 0,2290 | 0,0302 | 4,85 | 0,2617 | 0,0242 | 4,87 | 0,2617 | 0,0381 |
| A09- | Treglwang | Trieben | 1,91 | 0,1330 | 0,0068 | 1,91 | 0,1330 | 0,0107 | 2,68 | 0,1862 | 0,0156 | 2,69 | 0,1862 | 0,0246 | 3,95 | 0,2128 | 0,0197 | 3,96 | 0,2128 | 0,0310 |
| A09- | Kalwang | Treglwang | 2,56 | 0,1787 | 0,0091 | 2,57 | 0,1787 | 0,0143 | 3,60 | 0,2502 | 0,0210 | 3,61 | 0,2502 | 0,0330 | 5,30 | 0,2859 | 0,0265 | 5,32 | 0,2859 | 0,0416 |
| A09- | Mautern | Kalwang | 1,19 | 0,0832 | 0,0043 | 1,20 | 0,0832 | 0,0067 | 1,68 | 0,1165 | 0,0098 | 1,68 | 0,1165 | 0,0154 | 2,47 | 0,1331 | 0,0123 | 2,48 | 0,1331 | 0,0194 |
| A09- | Kammern | Mautern | 1,34 | 0,0936 | 0,0048 | 1,35 | 0,0936 | 0,0075 | 1,89 | 0,1311 | 0,0110 | 1,89 | 0,1311 | 0,0173 | 2,78 | 0,1498 | 0,0139 | 2,79 | 0,1498 | 0,0218 |
| A09- | Traboch | Kammern | 1,40 | 0,0979 | 0,0050 | 1,41 | 0,0979 | 0,0079 | 1,97 | 0,1370 | 0,0115 | 1,98 | 0,1370 | 0,0181 | 2,90 | 0,1566 | 0,0145 | 2,91 | 0,1566 | 0,0228 |
| A09- | Terminal St. Michael | Traboch | 0,28 | 0,0192 | 0,0010 | 0,28 | 0,0192 | 0,0015 | 0,39 | 0,0269 | 0,0023 | 0,39 | 0,0269 | 0,0035 | 0,57 | 0,0308 | 0,0028 | 0,57 | 0,0308 | 0,0045 |
| A09- | KN St. Michael | Terminal St. Michael | 0,52 | 0,0360 | 0,0018 | 0,52 | 0,0360 | 0,0029 | 0,73 | 0,0504 | 0,0042 | 0,73 | 0,0504 | 0,0067 | 1,07 | 0,0576 | 0,0053 | 1,07 | 0,0576 | 0,0084 |
| A09- | Übelbach | KN St. Michael | 10,40 | 0,3356 | 0,0171 | 10,41 | 0,3356 | 0,0269 | 14,58 | 0,4698 | 0,0394 | 14,60 | 0,4698 | 0,0620 | 21,69 | 0,5369 | 0,0497 | 21,71 | 0,5369 | 0,0781 |
| A09- | KN Peggau Deutschefstritz | Übelbach | 1,59 | 0,1110 | 0,0057 | 1,60 | 0,1110 | 0,0089 | 2,23 | 0,1554 | 0,0130 | 2,24 | 0,1554 | 0,0205 | 3,29 | 0,1776 | 0,0164 | 3,30 | 0,1776 | 0,0258 |
| A09- | Gratkorn Nord | KN Peggau Deutschefstritz | 0,75 | 0,0526 | 0,0027 | 0,76 | 0,0526 | 0,0042 | 1,06 | 0,0736 | 0,0062 | 1,06 | 0,0736 | 0,0097 | 1,56 | 0,0841 | 0,0078 | 1,56 | 0,0841 | 0,0122 |
| A09- | Gratkorn Süd | Gratkorn Nord | 0,83 | 0,0577 | 0,0030 | 0,83 | 0,0577 | 0,0046 | 1,16 | 0,0808 | 0,0068 | 1,17 | 0,0808 | 0,0107 | 1,71 | 0,0924 | 0,0086 | 1,72 | 0,0924 | 0,0134 |
| A09- | Graz Nord | Gratkorn Süd | 0,18 | 0,0128 | 0,0007 | 0,18 | 0,0128 | 0,0010 | 0,26 | 0,0179 | 0,0015 | 0,26 | 0,0179 | 0,0024 | 0,38 | 0,0205 | 0,0019 | 0,38 | 0,0205 | 0,0030 |
| A09- | Graz Webling | Graz Nord | 2,10 | 0,1464 | 0,0075 | 2,10 | 0,1464 | 0,0118 | 2,95 | 0,2049 | 0,0172 | 2,96 | 0,2049 | 0,0270 | 4,34 | 0,2342 | 0,0217 | 4,36 | 0,2342 | 0,0341 |
| A09- | Seiersberg | Graz Webling | 0,56 | 0,0389 | 0,0020 | 0,56 | 0,0389 | 0,0031 | 0,78 | 0,0545 | 0,0046 | 0,79 | 0,0545 | 0,0072 | 1,15 | 0,0623 | 0,0058 | 1,16 | 0,0623 | 0,0091 |
| A09- | KN Graz West | Seiersberg | 0,27 | 0,0190 | 0,0010 | 0,27 | 0,0190 | 0,0015 | 0,38 | 0,0267 | 0,0022 | 0,38 | 0,0267 | 0,0035 | 0,57 | 0,0305 | 0,0028 | 0,57 | 0,0305 | 0,0044 |
| A09- | Schwarzlsee | KN Graz West | 0,27 | 0,0188 | 0,0010 | 0,27 | 0,0188 | 0,0015 | 0,38 | 0,0263 | 0,0022 | 0,38 | 0,0263 | 0,0035 | 0,56 | 0,0300 | 0,0028 | 0,56 | 0,0300 | 0,0044 |
| A09- | Schachenwald / IBC Businesscenter | Schwarzlsee | 0,30 | 0,0210 | 0,0011 | 0,30 | 0,0210 | 0,0017 | 0,42 | 0,0294 | 0,0025 | 0,42 | 0,0294 | 0,0039 | 0,62 | 0,0336 | 0,0031 | 0,62 | 0,0336 | 0,0049 |
| A09- | Kalsdorf | Schachenwald / IBC Businesscenter | 0,31 | 0,0213 | 0,0011 | 0,31 | 0,0213 | 0,0017 | 0,43 | 0,0299 | 0,0025 | 0,43 | 0,0299 | 0,0039 | 0,63 | 0,0342 | 0,0032 | 0,64 | 0,0342 | 0,0050 |
| A09- | Werndorf Terminal | Kalsdorf | 0,77 | 0,0534 | 0,0027 | 0,77 | 0,0534 | 0,0043 | 1,08 | 0,0748 | 0,0063 | 1,08 | 0,0748 | 0,0099 | 1,59 | 0,0855 | 0,0079 | 1,59 | 0,0855 | 0,0124 |
| A09- | Wildon | Werndorf Terminal | 0,86 | 0,0597 | 0,0031 | 0,86 | 0,0597 | 0,0048 | 1,20 | 0,0836 | 0,0070 | 1,21 | 0,0836 | 0,0110 | 1,77 | 0,0955 | 0,0088 | 1,78 | 0,0955 | 0,0139 |
| A09- | Hengsberg | Wildon | 0,42 | 0,0292 | 0,0015 | 0,42 | 0,0292 | 0,0023 | 0,59 | 0,0408 | 0,0034 | 0,59 | 0,0408 | 0,0054 | 0,87 | 0,0466 | 0,0043 | 0,87 | 0,0466 | 0,0068 |
| A09- | Lebring | Hengsberg | 0,74 | 0,0516 | 0,0026 | 0,74 | 0,0516 | 0,0041 | 1,04 | 0,0723 | 0,0061 | 1,04 | 0,0723 | 0,0095 | 1,53 | 0,0826 | 0,0077 | 1,54 | 0,0826 | 0,0120 |
| A09- | Leibnitz | Lebring | 1,28 | 0,0894 | 0,0046 | 1,29 | 0,0894 | 0,0072 | 1,80 | 0,1252 | 0,0105 | 1,81 | 0,1252 | 0,0165 | 2,65 | 0,1430 | 0,0132 | 2,66 | 0,1430 | 0,0208 |
| A09- | Vogau Straß | Leibnitz | 1,57 | 0,1093 | 0,0056 | 1,57 | 0,1093 | 0,0088 | 2,20 | 0,1531 | 0,0128 | 2,21 | 0,1531 | 0,0202 | 3,24 | 0,1749 | 0,0162 | 3,25 | 0,1749 | 0,0255 |
| A09- | Gersdorf | Vogau Straß | 0,76 | 0,0530 | 0,0027 | 0,76 | 0,0530 | 0,0043 | 1,07 | 0,0742 | 0,0062 | 1,07 | 0,0742 | 0,0098 | 1,57 | 0,0849 | 0,0079 | 1,58 | 0,0849 | 0,0123 |
| A09- | Spielfeld | Gersdorf | 0,40 | 0,0279 | 0,0014 | 0,40 | 0,0279 | 0,0022 | 0,56 | 0,0391 | 0,0033 | 0,56 | 0,0391 | 0,0052 | 0,83 | 0,0447 | 0,0041 | 0,83 | 0,0447 | 0,0065 |
| A09- | Staatsgrenze Spielfeld | Spielfeld | 0,37 | 0,0255 | 0,0013 | 0,37 | 0,0255 | 0,0020 | 0,51 | 0,0357 | 0,0030 | 0,51 | 0,0357 | 0,0047 | 0,76 | 0,0408 | 0,0038 | 0,76 | 0,0408 | 0,0059 |
| A10- | Salzburg Süd / Anif | KN Salzburg | 1,48 | 0,1031 | 0,0053 | 1,48 | 0,1031 | 0,0083 | 2,08 | 0,1443 | 0,0121 | 2,08 | 0,1443 | 0,0190 | 3,06 | 0,1649 | 0,0153 | 3,07 | 0,1649 | 0,0240 |
| A10- | Puch Urstein | Salzburg Süd / Anif | 0,50 | 0,0350 | 0,0018 | 0,50 | 0,0350 | 0,0028 | 0,70 | 0,0490 | 0,0041 | 0,71 | 0,0490 | 0,0065 | 1,04 | 0,0560 | 0,0052 | 1,04 | 0,0560 | 0,0081 |
| A10- | Hallein | Puch Urstein | 1,04 | 0,0722 | 0,0037 | 1,04 | 0,0722 | 0,0058 | 1,45 | 0,1011 | 0,0085 | 1,46 | 0,1011 | 0,0133 | 2,14 | 0,1155 | 0,0107 | 2,15 | 0,1155 | 0,0168 |
| A10- | Kuchl | Hallein | 1,15 | 0,0802 | 0,0041 | 1,15 | 0,0802 | 0,0064 | 1,61 | 0,1123 | 0,0094 | 1,62 | 0,1123 | 0,0148 | 2,38 | 0,1283 | 0,0119 | 2,39 | 0,1283 | 0,0187 |
| A10- | Golling / Abtenau | Kuchl | 1,16 | 0,0806 | 0,0041 | 1,16 | 0,0806 | 0,0065 | 1,62 | 0,1129 | 0,0095 | 1,63 | 0,1129 | 0,0149 | 2,39 | 0,1290 | 0,0119 | 2,40 | 0,1290 | 0,0188 |
| A10- | Paß Lueg | Golling / Abtenau | 1,21 | 0,0841 | 0,0043 | 1,21 | 0,0841 | 0,0068 | 1,69 | 0,1178 | 0,0099 | 1,70 | 0,1178 | 0,0155 | 2,50 | 0,1346 | 0,0125 | 2,50 | 0,1346 | 0,0196 |
| A10- | Werfen | Paß Lueg | 1,72 | 0,1198 | 0,0061 | 1,72 | 0,1198 | 0,0096 | 2,41 | 0,1678 | 0,0141 | 2,42 | 0,1678 | 0,0221 | 3,56 | 0,1917 | 0,0178 | 3,57 | 0,1917 | 0,0279 |
| A10- | Pfarrwerfen / Werfen | Werfen | 0,22 | 0,0156 | 0,0008 | 0,22 | 0,0156 | 0,0013 | 0,31 | 0,0219 | 0,0018 | 0,32 | 0,0219 | 0,0029 | 0,46 | 0,0250 | 0,0023 | 0,46 | 0,0250 | 0,0036 |
| A10- | KN Pongau | Pfarrwerfen / Werfen | 0,49 | 0,0339 | 0,0017 | 0,49 | 0,0339 | 0,0027 | 0,68 | 0,0475 | 0,0040 | 0,68 | 0,0475 | 0,0063 | 1,01 | 0,0542 | 0,0050 | 1,01 | 0,0542 | 0,0079 |
| A101 | Bischofshofen Mühlbach a. Hochkönig | KN Pongau | 0,72 | 0,0504 | 0,0026 | 0,72 | 0,0504 | 0,0040 | 1,02 | 0,0706 | 0,0059 | 1,02 | 0,0706 | 0,0093 | 1,50 | 0,0807 | 0,0075 | 1,50 | 0,0807 | 0,0117 |
| A10- | Lammertal Hüttal | KN Pongau | 1,98 | 0,1379 | 0,0070 | 1,98 | 0,1379 | 0,0111 | 2,78 | 0,1930 | 0,0162 | 2,79 | 0,1930 | 0,0255 | 4,09 | 0,2206 | 0,0204 | 4,10 | 0,2206 | 0,0321 |
| A10- | F. Verbindung GH Eben | Lammertal Hüttal | 0,51 | 0,0355 | 0,0018 | 0,51 | 0,0355 | 0,0028 | 0,71 | 0,0497 | 0,0042 | 0,72 | 0,0497 | 0,0066 | 1,05 | 0,0568 | 0,0053 | 1,06 | 0,0568 | 0,008 |

| | | | | | | | | | | | | | | | | | | | | |
|------|-------------------------------------|-------------------------------------|------|--------|--------|------|--------|--------|------|--------|--------|------|--------|--------|-------|--------|--------|-------|--------|--------|
| A12- | Kufstein Nord | Staatsgrenze Kufstein | 0,36 | 0,0000 | 0,0000 | 0,36 | 0,0000 | 0,0000 | 0,51 | 0,0000 | 0,0000 | 0,51 | 0,0000 | 0,0000 | 0,76 | 0,0000 | 0,0000 | 0,76 | 0,0000 | 0,0000 |
| A12- | Kufstein Süd | Kufstein Nord | 0,93 | 0,0000 | 0,0000 | 0,93 | 0,0000 | 0,0000 | 1,31 | 0,0000 | 0,0000 | 1,31 | 0,0000 | 0,0000 | 1,96 | 0,0000 | 0,0000 | 1,96 | 0,0000 | 0,0000 |
| A12- | Kirchbichl Langkampfen | Kufstein Süd | 1,27 | 0,0000 | 0,0000 | 1,27 | 0,0000 | 0,0000 | 1,78 | 0,0000 | 0,0000 | 1,78 | 0,0000 | 0,0000 | 2,68 | 0,0000 | 0,0000 | 2,68 | 0,0000 | 0,0000 |
| A12- | Wörgl Ost St.Johann i. T. Brixental | Kirchbichl Langkampfen | 1,25 | 0,0000 | 0,0000 | 1,25 | 0,0000 | 0,0000 | 1,75 | 0,0000 | 0,0000 | 1,75 | 0,0000 | 0,0000 | 2,62 | 0,0000 | 0,0000 | 2,62 | 0,0000 | 0,0000 |
| A12- | Wörgl West | Wörgl Ost St.Johann i. T. Brixental | 0,66 | 0,0000 | 0,0000 | 0,66 | 0,0000 | 0,0000 | 0,92 | 0,0000 | 0,0000 | 0,92 | 0,0000 | 0,0000 | 1,38 | 0,0000 | 0,0000 | 1,38 | 0,0000 | 0,0000 |
| A12- | Kramsach Rattenberg Brixlegg | Wörgl West | 2,80 | 0,0000 | 0,0000 | 2,80 | 0,0000 | 0,0000 | 3,92 | 0,0000 | 0,0000 | 3,92 | 0,0000 | 0,0000 | 5,88 | 0,0000 | 0,0000 | 5,88 | 0,0000 | 0,0000 |
| A12- | Wiesing Achensee Zillertal | Kramsach Rattenberg Brixlegg | 1,72 | 0,0000 | 0,0000 | 1,72 | 0,0000 | 0,0000 | 2,40 | 0,0000 | 0,0000 | 2,40 | 0,0000 | 0,0000 | 3,61 | 0,0000 | 0,0000 | 3,61 | 0,0000 | 0,0000 |
| A12- | Jenbach | Wiesing Achensee Zillertal | 0,68 | 0,0000 | 0,0000 | 0,68 | 0,0000 | 0,0000 | 0,95 | 0,0000 | 0,0000 | 0,95 | 0,0000 | 0,0000 | 1,43 | 0,0000 | 0,0000 | 1,43 | 0,0000 | 0,0000 |
| A12- | Schwaz | Jenbach | 1,50 | 0,0000 | 0,0000 | 1,50 | 0,0000 | 0,0000 | 2,10 | 0,0000 | 0,0000 | 2,10 | 0,0000 | 0,0000 | 3,15 | 0,0000 | 0,0000 | 3,15 | 0,0000 | 0,0000 |
| A12- | Vomp | Schwaz | 0,86 | 0,0000 | 0,0000 | 0,86 | 0,0000 | 0,0000 | 1,20 | 0,0000 | 0,0000 | 1,20 | 0,0000 | 0,0000 | 1,80 | 0,0000 | 0,0000 | 1,80 | 0,0000 | 0,0000 |
| A12- | Wattens | Vomp | 1,77 | 0,0000 | 0,0000 | 1,77 | 0,0000 | 0,0000 | 2,47 | 0,0000 | 0,0000 | 2,47 | 0,0000 | 0,0000 | 3,71 | 0,0000 | 0,0000 | 3,71 | 0,0000 | 0,0000 |
| A12- | Hall/Tirol Mitte | Wattens | 1,57 | 0,0000 | 0,0000 | 1,57 | 0,0000 | 0,0000 | 2,19 | 0,0000 | 0,0000 | 2,19 | 0,0000 | 0,0000 | 3,29 | 0,0000 | 0,0000 | 3,29 | 0,0000 | 0,0000 |
| A12- | Hall/Tirol West | Hall/Tirol Mitte | 0,63 | 0,0000 | 0,0000 | 0,63 | 0,0000 | 0,0000 | 0,88 | 0,0000 | 0,0000 | 0,88 | 0,0000 | 0,0000 | 1,32 | 0,0000 | 0,0000 | 1,32 | 0,0000 | 0,0000 |
| A12- | A12 Innsbruck Ost | Hall/Tirol West | 0,70 | 0,0000 | 0,0000 | 0,70 | 0,0000 | 0,0000 | 0,97 | 0,0000 | 0,0000 | 0,97 | 0,0000 | 0,0000 | 1,46 | 0,0000 | 0,0000 | 1,46 | 0,0000 | 0,0000 |
| A12- | Innsbruck Mitte | A12 Innsbruck Ost | 0,46 | 0,0078 | 0,0004 | 0,46 | 0,0078 | 0,0006 | 0,65 | 0,0109 | 0,0009 | 0,65 | 0,0109 | 0,0014 | 0,97 | 0,0124 | 0,0011 | 0,97 | 0,0124 | 0,0018 |
| A12- | A12 Innsbruck West | Innsbruck Mitte | 0,63 | 0,0438 | 0,0022 | 0,63 | 0,0438 | 0,0035 | 0,88 | 0,0614 | 0,0052 | 0,89 | 0,0614 | 0,0081 | 1,30 | 0,0701 | 0,0065 | 1,30 | 0,0701 | 0,0102 |
| A12- | Innsbruck Kranebitten | A12 Innsbruck West | 0,82 | 0,0575 | 0,0029 | 0,83 | 0,0575 | 0,0046 | 1,16 | 0,0804 | 0,0068 | 1,16 | 0,0804 | 0,0106 | 1,71 | 0,0919 | 0,0085 | 1,71 | 0,0919 | 0,0134 |
| A12- | Zirl Ost Garmisch Seefeld | Innsbruck Kranebitten | 0,96 | 0,0667 | 0,0034 | 0,96 | 0,0667 | 0,0054 | 1,34 | 0,0933 | 0,0078 | 1,35 | 0,0933 | 0,0123 | 1,98 | 0,1067 | 0,0099 | 1,98 | 0,1067 | 0,0155 |
| A12- | Zirl West | Zirl Ost Garmisch Seefeld | 0,60 | 0,0417 | 0,0021 | 0,60 | 0,0417 | 0,0033 | 0,84 | 0,0584 | 0,0049 | 0,84 | 0,0584 | 0,0077 | 1,24 | 0,0667 | 0,0062 | 1,24 | 0,0667 | 0,0097 |
| A12- | Petttau | Zirl West | 1,07 | 0,0747 | 0,0038 | 1,07 | 0,0747 | 0,0060 | 1,50 | 0,1046 | 0,0088 | 1,51 | 0,1046 | 0,0138 | 2,22 | 0,1195 | 0,0111 | 2,22 | 0,1195 | 0,0174 |
| A12- | Telfs Ost | Petttau | 1,08 | 0,0755 | 0,0039 | 1,09 | 0,0755 | 0,0061 | 1,52 | 0,1057 | 0,0089 | 1,53 | 0,1057 | 0,0139 | 2,24 | 0,1208 | 0,0112 | 2,25 | 0,1208 | 0,0176 |
| A12- | Telfs West | Telfs Ost | 0,53 | 0,0369 | 0,0019 | 0,53 | 0,0369 | 0,0030 | 0,74 | 0,0516 | 0,0043 | 0,75 | 0,0516 | 0,0068 | 1,09 | 0,0590 | 0,0055 | 1,10 | 0,0590 | 0,0086 |
| A12- | Mötz Reutte | Telfs West | 1,71 | 0,1192 | 0,0061 | 1,71 | 0,1192 | 0,0096 | 2,40 | 0,1669 | 0,0140 | 2,41 | 0,1669 | 0,0220 | 3,54 | 0,1907 | 0,0177 | 3,55 | 0,1907 | 0,0278 |
| A12- | Haiming Ötztal | Mötz Reutte | 1,99 | 0,1386 | 0,0071 | 1,99 | 0,1386 | 0,0111 | 2,79 | 0,1941 | 0,0163 | 2,80 | 0,1941 | 0,0256 | 4,11 | 0,2218 | 0,0205 | 4,13 | 0,2218 | 0,0323 |
| A12- | Imst | Haiming Ötztal | 1,58 | 0,1104 | 0,0056 | 1,59 | 0,1104 | 0,0089 | 2,22 | 0,1545 | 0,0130 | 2,23 | 0,1545 | 0,0204 | 3,28 | 0,1766 | 0,0164 | 3,28 | 0,1766 | 0,0257 |
| A12- | Imst Au | Imst | 0,47 | 0,0326 | 0,0017 | 0,47 | 0,0326 | 0,0026 | 0,66 | 0,0456 | 0,0038 | 0,66 | 0,0456 | 0,0060 | 0,97 | 0,0521 | 0,0048 | 0,97 | 0,0521 | 0,0076 |
| A12- | Mils | Imst Au | 0,38 | 0,0263 | 0,0013 | 0,38 | 0,0263 | 0,0021 | 0,53 | 0,0368 | 0,0031 | 0,53 | 0,0368 | 0,0049 | 0,78 | 0,0420 | 0,0039 | 0,78 | 0,0420 | 0,0061 |
| A12- | Mils Schönwies | Mils | 0,93 | 0,0647 | 0,0033 | 0,93 | 0,0647 | 0,0052 | 1,30 | 0,0905 | 0,0076 | 1,31 | 0,0905 | 0,0119 | 1,92 | 0,1035 | 0,0096 | 1,92 | 0,1035 | 0,0151 |
| A12- | KN Oberinntal | Mils Schönwies | 0,82 | 0,0573 | 0,0029 | 0,82 | 0,0573 | 0,0046 | 1,15 | 0,0802 | 0,0067 | 1,16 | 0,0802 | 0,0106 | 1,70 | 0,0916 | 0,0085 | 1,70 | 0,0916 | 0,0133 |
| A12- | Zams | KN Oberinntal | 0,22 | 0,0151 | 0,0008 | 0,22 | 0,0151 | 0,0012 | 0,30 | 0,0211 | 0,0018 | 0,30 | 0,0211 | 0,0028 | 0,45 | 0,0241 | 0,0022 | 0,45 | 0,0241 | 0,0035 |
| A122 | Fließ | KN Oberinntal | 1,54 | 0,1071 | 0,0055 | 1,54 | 0,1071 | 0,0086 | 2,16 | 0,1500 | 0,0126 | 2,16 | 0,1500 | 0,0198 | 3,18 | 0,1714 | 0,0159 | 3,19 | 0,1714 | 0,0249 |
| A13- | A13 Innsbruck Süd | A12 Innsbruck Ost | 2,20 | 0,0000 | 0,0000 | 2,20 | 0,0000 | 0,0000 | 3,08 | 0,0000 | 0,0000 | 3,08 | 0,0000 | 0,0000 | 4,62 | 0,0000 | 0,0000 | 8,50 | 0,0000 | 0,0000 |
| A13- | Zenzenhof | A13 Innsbruck Süd | 0,88 | 0,0000 | 0,0000 | 0,88 | 0,0000 | 0,0000 | 1,23 | 0,0000 | 0,0000 | 1,23 | 0,0000 | 0,0000 | 1,84 | 0,0000 | 0,0000 | 3,68 | 0,0000 | 0,0000 |
| A13- | Igls Patsch | Zenzenhof | 1,62 | 0,0000 | 0,0000 | 1,62 | 0,0000 | 0,0000 | 2,27 | 0,0000 | 0,0000 | 2,27 | 0,0000 | 0,0000 | 3,41 | 0,0000 | 0,0000 | 6,82 | 0,0000 | 0,0000 |
| A13- | Schönberg Stubaital | Igls Patsch | 1,76 | 0,0000 | 0,0000 | 1,76 | 0,0000 | 0,0000 | 2,46 | 0,0000 | 0,0000 | 2,46 | 0,0000 | 0,0000 | 3,69 | 0,0000 | 0,0000 | 7,38 | 0,0000 | 0,0000 |
| A13- | Matrei Steinach | Schönberg Stubaital | 5,54 | 0,0000 | 0,0000 | 5,54 | 0,0000 | 0,0000 | 7,76 | 0,0000 | 0,0000 | 7,76 | 0,0000 | 0,0000 | 11,63 | 0,0000 | 0,0000 | 23,26 | 0,0000 | 0,0000 |
| A13- | Nösslach | Matrei Steinach | 4,46 | 0,0000 | 0,0000 | 4,46 | 0,0000 | 0,0000 | 6,24 | 0,0000 | 0,0000 | 6,24 | 0,0000 | 0,0000 | 9,36 | 0,0000 | 0,0000 | 18,72 | 0,0000 | 0,0000 |
| A13- | Brenner-Nord | Nösslach | 4,00 | 0,0000 | 0,0000 | 4,00 | 0,0000 | 0,0000 | 5,60 | 0,0000 | 0,0000 | 5,60 | 0,0000 | 0,0000 | 8,40 | 0,0000 | 0,0000 | 16,80 | 0,0000 | 0,0000 |
| A13- | Staatsgrenze Brennerpass | Brenner-Nord | 0,79 | 0,0000 | 0,0000 | 0,79 | 0,0000 | 0,0000 | 1,11 | 0,0000 | 0,0000 | 1,11 | 0,0000 | 0,0000 | 1,66 | 0,0000 | 0,0000 | 3,32 | 0,0000 | 0,0000 |
| A131 | A13 Innsbruck Süd | A12 Innsbruck West | 1,40 | 0,0143 | 0,0007 | 1,41 | 0,0143 | 0,0011 | 1,97 | 0,0200 | 0,0017 | 1,97 | 0,0200 | 0,0026 | 2,94 | 0,0228 | 0,0021 | 5,46 | 0,0228 | 0,0033 |
| A14- | Hörbranz Lochau | Staatsgrenze Hörbranz | 0,25 | 0,0173 | 0,0009 | 0,25 | 0,0173 | 0,0014 | 0,35 | 0,0242 | 0,0020 | 0,35 | 0,0242 | 0,0032 | 0,51 | 0,0276 | 0,0026 | 0,51 | 0,0276 | 0,0040 |
| A14- | KN Bregenz | Hörbranz Lochau | 1,52 | 0,1062 | 0,0054 | 1,53 | 0,1062 | 0,0085 | 2,14 | 0,1486 | 0,0125 | 2,14 | 0,1486 | 0,0196 | 3,15 | 0,1699 | 0,0157 | 3,16 | 0,1699 | 0,0247 |
| A14- | Lauterach Wolfurt | KN Bregenz | 0,08 | 0,0053 | 0,0003 | 0,08 | 0,0053 | 0,0004 | 0,11 | 0,0075 | 0,0006 | 0,11 | 0,0075 | 0,0010 | 0,16 | 0,0085 | 0,0008 | 0,16 | 0,0085 | 0,0012 |
| A14- | Wolfurt Lauterach | Lauterach Wolfurt | 0,68 | 0,0472 | 0,0024 | 0,68 | 0,0472 | 0,0038 | 0,95 | 0,0661 | 0,0056 | 0,95 | 0,0661 | 0,0087 | 1,40 | 0,0756 | 0,0070 | 1,41 | 0,0756 | 0,0110 |
| A14- | Dornbirn Nord Bregenzerwald | Wolfurt Lauterach | 0,26 | 0,0183 | 0,0009 | 0,26 | 0,0183 | 0,0015 | 0,37 | 0,0256 | 0,0021 | 0,37 | 0,0256 | 0,0034 | 0,54 | 0,0292 | 0,0027 | 0,54 | 0,0292 | 0,0043 |
| A14- | Dornbirn Süd Lustenau | Dornbirn Nord Bregenzerwald | 0,73 | 0,0511 | 0,0026 | 0,73 | 0,0511 | 0,0041 | 1,03 | 0,0715 | 0,0060 | 1,03 | 0,0715 | 0,0094 | 1,52 | 0,0817 | 0,0076 | 1,52 | 0,0817 | 0,0119 |
| A14- | Hohenems | Dornbirn Süd Lustenau | 1,03 | 0,0718 | 0,0037 | 1,03 | 0,0718 | 0,0058 | 1,45 | 0,1006 | 0,0084 | 1,45 | 0,1006 | 0,0133 | 2,13 | 0,1149 | 0,0106 | 2,14 | 0,1149 | 0,0167 |
| A14- | Altach Götzis | Hohenems | 0,67 | 0,0468 | 0,0024 | 0,67 | 0,0468 | 0,0038 | 0,94 | 0,0656 | 0,0055 | 0,95 | 0,0656 | 0,0087 | 1,39 | 0,0749 | 0,0069 | 1,39 | 0,0749 | 0,0109 |
| A14- | Götzis | Altach Götzis | 0,51 | 0,0357 | 0,0018 | 0,51 | 0,0357 | 0,0029 | 0,72 | 0,0500 | 0,0042 | 0,72 | 0,0500 | 0,0066 | 1,06 | 0,0571 | 0,0053 | 1,06 | 0,0571 | 0,0083 |
| A14- | Klaus Koblach | Götzis | 0,45 | 0,0310 | 0,0016 | 0,45 | 0,0310 | 0,0025 | 0,62 | 0,0434 | 0,0036 | 0,63 | 0,0434 | 0,0057 | 0,92 | 0,0496 | 0,0046 | 0,92 | 0,0496 | 0,0072 |
| A14- | Rankweil | Klaus Koblach | 0,78 | 0,0545 | 0,0028 | 0,78 | 0,0545 | 0,0044 | 1,10 | 0,0763 | 0,0064 | 1,10 | 0,0763 | 0,0101 | 1,62 | 0,0872 | 0,0081 | 1,62 | 0,0872 | 0,0127 |
| A14- | Feldkirch Frastanz | Rankweil | 1,11 | 0,0777 | 0,0040 | 1,12 | 0,0777 | 0,0062 | 1,56 | 0,1087 | 0,0091 | 1,57 | 0,1087 | 0,0143 | 2,30 | 0,1242 | 0,0115 | 2,31 | 0,1242 | 0,0181 |
| A14- | Nenzing Bludesch | Feldkirch Frastanz | 1,76 | 0,1228 | 0,0063 | 1,77 | 0,1228 | 0,0099 | 2,47 | 0,1719 | 0,0144 | 2,48 | 0,1719 | 0,0227 | 3,64 | 0,1965 | 0,0182 | 3,65 | 0,1965 | 0,0286 |
| A14- | Bludenz Nüziders | Nenzing Bludesch | 1,31 | 0,0912 | 0,0047 | 1,31 | 0,0912 | 0,0073 | 1,84 | 0,1276 | 0,0107 | 1,84 | 0,1276 | 0,0168 | 2,71 | 0,1459 | 0,0135 | 2,71 | 0,1459 | 0,0212 |
| A14- | Brandnertal | Bludenz Nüziders | 0,18 | 0,0127 | 0,0006 | 0,18 | 0,0127 | 0,0010 | 0,26 | 0,0178 | 0,0015 | 0,26 | 0,0178 | 0,0023 | 0,38 | 0,0203 | 0,0019 | 0,38 | 0,0203 | 0,0030 |
| A14- | Bludenz Bürs | Brandnertal | 0,30 | 0,0212 | 0,0011 | 0,30 | 0,0212 | 0,0017 | 0,43 | 0,0296 | 0,0025 | 0,43 | 0,0296 | 0,0039 | 0,63 | 0,0339 | 0,0031 | 0,63 | 0,0339 | 0,0049 |
| A14- | Bludenz Montafon | Bludenz Bürs | 0,43 | 0,030 | | | | | | | | | | | | | | | | |

| | | | | | | | | | | | | | | | | | | | | |
|------|--------------------------------------|--------------------------------------|------|--------|--------|------|--------|--------|------|--------|--------|------|--------|--------|------|--------|--------|------|--------|--------|
| A22- | Strebersdorf | KN Gürtel Nordbrücke | 0,59 | 0,0412 | 0,0021 | 0,59 | 0,0412 | 0,0033 | 0,83 | 0,0577 | 0,0048 | 0,83 | 0,0577 | 0,0076 | 1,22 | 0,0659 | 0,0061 | 1,23 | 0,0659 | 0,0096 |
| A221 | KN Gürtel Nordbrücke | Wien Nordbrücke | 0,17 | 0,0122 | 0,0006 | 0,17 | 0,0122 | 0,0010 | 0,24 | 0,0170 | 0,0014 | 0,25 | 0,0170 | 0,0022 | 0,36 | 0,0194 | 0,0018 | 0,36 | 0,0194 | 0,0028 |
| A221 | Wien Pragerstraße | KN Gürtel Nordbrücke | 0,19 | 0,0131 | 0,0007 | 0,19 | 0,0131 | 0,0011 | 0,26 | 0,0183 | 0,0015 | 0,26 | 0,0183 | 0,0024 | 0,39 | 0,0209 | 0,0019 | 0,39 | 0,0209 | 0,0030 |
| A221 | Wien Neujedlersdorf | Wien Pragerstraße | 0,08 | 0,0057 | 0,0003 | 0,08 | 0,0057 | 0,0005 | 0,12 | 0,0080 | 0,0007 | 0,12 | 0,0080 | 0,0011 | 0,17 | 0,0092 | 0,0008 | 0,17 | 0,0092 | 0,0013 |
| A221 | Brünnerstr/Shuttlewort hstraße | Wien Neujedlersdorf | 0,21 | 0,0145 | 0,0007 | 0,21 | 0,0145 | 0,0012 | 0,29 | 0,0203 | 0,0017 | 0,29 | 0,0203 | 0,0027 | 0,43 | 0,0232 | 0,0022 | 0,43 | 0,0232 | 0,0034 |
| A22- | Korneuburg Ost | Strebersdorf | 1,19 | 0,0830 | 0,0042 | 1,19 | 0,0830 | 0,0067 | 1,67 | 0,1162 | 0,0098 | 1,68 | 0,1162 | 0,0153 | 2,46 | 0,1328 | 0,0123 | 2,47 | 0,1328 | 0,0193 |
| A222 | Wien Vohburggasse | Strebersdorf | 0,15 | 0,0103 | 0,0005 | 0,15 | 0,0103 | 0,0008 | 0,21 | 0,0144 | 0,0012 | 0,21 | 0,0144 | 0,0019 | 0,31 | 0,0165 | 0,0015 | 0,31 | 0,0165 | 0,0024 |
| A22- | KN Korneuburg | Korneuburg Ost | 0,77 | 0,0536 | 0,0027 | 0,77 | 0,0536 | 0,0043 | 1,08 | 0,0750 | 0,0063 | 1,08 | 0,0750 | 0,0099 | 1,59 | 0,0857 | 0,0079 | 1,59 | 0,0857 | 0,0125 |
| A22- | Stockerau Ost | KN Korneuburg | 1,12 | 0,0780 | 0,0040 | 1,12 | 0,0780 | 0,0063 | 1,57 | 0,1091 | 0,0092 | 1,57 | 0,1091 | 0,0144 | 2,31 | 0,1247 | 0,0116 | 2,32 | 0,1247 | 0,0182 |
| A22- | Stockerau Mitte | Stockerau Ost | 0,45 | 0,0311 | 0,0016 | 0,45 | 0,0311 | 0,0025 | 0,63 | 0,0435 | 0,0037 | 0,63 | 0,0435 | 0,0057 | 0,92 | 0,0497 | 0,0046 | 0,93 | 0,0497 | 0,0072 |
| A22- | KN Stockerau/West | Stockerau Mitte | 0,38 | 0,0264 | 0,0013 | 0,38 | 0,0264 | 0,0021 | 0,53 | 0,0370 | 0,0031 | 0,53 | 0,0370 | 0,0049 | 0,78 | 0,0422 | 0,0039 | 0,79 | 0,0422 | 0,0061 |
| A23- | KN Wien Inzersdorf | Altmannsdorferstraße | 0,33 | 0,0231 | 0,0012 | 0,33 | 0,0231 | 0,0019 | 0,47 | 0,0323 | 0,0027 | 0,47 | 0,0323 | 0,0043 | 0,69 | 0,0370 | 0,0034 | 0,69 | 0,0370 | 0,0054 |
| A23- | Favoriten | KN Wien Inzersdorf | 0,84 | 0,0583 | 0,0030 | 0,84 | 0,0583 | 0,0047 | 1,17 | 0,0816 | 0,0068 | 1,18 | 0,0816 | 0,0108 | 1,73 | 0,0932 | 0,0086 | 1,73 | 0,0932 | 0,0136 |
| A23- | KN Gürtel Landstraßer Hauptstraße | Favoriten | 0,52 | 0,0365 | 0,0019 | 0,52 | 0,0365 | 0,0029 | 0,73 | 0,0511 | 0,0043 | 0,74 | 0,0511 | 0,0067 | 1,08 | 0,0584 | 0,0054 | 1,09 | 0,0584 | 0,0085 |
| A23- | St. Marx | KN Gürtel Landstraßer Hauptstraße | 0,20 | 0,0139 | 0,0007 | 0,20 | 0,0139 | 0,0011 | 0,28 | 0,0194 | 0,0016 | 0,28 | 0,0194 | 0,0026 | 0,41 | 0,0222 | 0,0021 | 0,41 | 0,0222 | 0,0032 |
| A23- | KN Wien Prater | St. Marx | 0,17 | 0,0118 | 0,0006 | 0,17 | 0,0118 | 0,0009 | 0,24 | 0,0165 | 0,0014 | 0,24 | 0,0165 | 0,0022 | 0,35 | 0,0188 | 0,0017 | 0,35 | 0,0188 | 0,0027 |
| A23- | Handelskai | KN Wien Prater | 0,37 | 0,0261 | 0,0013 | 0,38 | 0,0261 | 0,0021 | 0,53 | 0,0365 | 0,0031 | 0,53 | 0,0365 | 0,0048 | 0,77 | 0,0418 | 0,0039 | 0,78 | 0,0418 | 0,0061 |
| A23- | KN Wien Kaisermühlen | Handelskai | 0,17 | 0,0119 | 0,0006 | 0,17 | 0,0119 | 0,0010 | 0,24 | 0,0167 | 0,0014 | 0,24 | 0,0167 | 0,0022 | 0,35 | 0,0191 | 0,0018 | 0,36 | 0,0191 | 0,0028 |
| A23- | Groß Enzersdorf Stadlau | KN Wien Kaisermühlen | 0,47 | 0,0327 | 0,0017 | 0,47 | 0,0327 | 0,0026 | 0,66 | 0,0458 | 0,0038 | 0,66 | 0,0458 | 0,0060 | 0,97 | 0,0524 | 0,0049 | 0,97 | 0,0524 | 0,0076 |
| A23- | Hirschstetten | Groß Enzersdorf Stadlau | 0,26 | 0,0184 | 0,0009 | 0,26 | 0,0184 | 0,0015 | 0,37 | 0,0257 | 0,0022 | 0,37 | 0,0257 | 0,0034 | 0,54 | 0,0294 | 0,0027 | 0,55 | 0,0294 | 0,0043 |
| A233 | Wien Gürtel | KN Gürtel Landstraßer Hauptstraße | 0,15 | 0,0107 | 0,0005 | 0,15 | 0,0107 | 0,0009 | 0,22 | 0,0150 | 0,0013 | 0,22 | 0,0150 | 0,0020 | 0,32 | 0,0171 | 0,0016 | 0,32 | 0,0171 | 0,0025 |
| A25- | Weißkirchen | KN A1/A25 Passau Wels | 1,73 | 0,1208 | 0,0062 | 1,74 | 0,1208 | 0,0097 | 2,43 | 0,1691 | 0,0142 | 2,44 | 0,1691 | 0,0223 | 3,58 | 0,1932 | 0,0179 | 3,59 | 0,1932 | 0,0281 |
| A25- | Marchtrenk Wels Ost | Weißkirchen | 0,62 | 0,0430 | 0,0022 | 0,62 | 0,0430 | 0,0035 | 0,87 | 0,0602 | 0,0051 | 0,87 | 0,0602 | 0,0079 | 1,28 | 0,0689 | 0,0064 | 1,28 | 0,0689 | 0,0100 |
| A25- | ÖBB Terminal Wels | Marchtrenk Wels Ost | 0,17 | 0,0116 | 0,0006 | 0,17 | 0,0116 | 0,0009 | 0,23 | 0,0162 | 0,0014 | 0,23 | 0,0162 | 0,0021 | 0,34 | 0,0185 | 0,0017 | 0,34 | 0,0185 | 0,0027 |
| A25- | Wels Nord | ÖBB Terminal Wels | 0,80 | 0,0555 | 0,0028 | 0,80 | 0,0555 | 0,0045 | 1,12 | 0,0777 | 0,0065 | 1,12 | 0,0777 | 0,0102 | 1,65 | 0,0888 | 0,0082 | 1,65 | 0,0888 | 0,0129 |
| A25- | KN Wels | Wels Nord | 0,57 | 0,0395 | 0,0020 | 0,57 | 0,0395 | 0,0032 | 0,80 | 0,0553 | 0,0046 | 0,80 | 0,0553 | 0,0073 | 1,17 | 0,0632 | 0,0059 | 1,18 | 0,0632 | 0,0092 |
| S01- | Vorarlberger Allee | KN Vösendorf | 0,42 | 0,0293 | 0,0015 | 0,42 | 0,0293 | 0,0024 | 0,59 | 0,0410 | 0,0034 | 0,59 | 0,0410 | 0,0054 | 0,87 | 0,0468 | 0,0043 | 0,87 | 0,0468 | 0,0068 |
| S01- | Laxenburger Str. | Vorarlberger Allee | 0,22 | 0,0154 | 0,0008 | 0,22 | 0,0154 | 0,0012 | 0,31 | 0,0215 | 0,0018 | 0,31 | 0,0215 | 0,0028 | 0,46 | 0,0246 | 0,0023 | 0,46 | 0,0246 | 0,0036 |
| S01- | Güterzentrum Wien Süd | Laxenburger Str. | 0,27 | 0,0191 | 0,0010 | 0,27 | 0,0191 | 0,0015 | 0,38 | 0,0267 | 0,0022 | 0,39 | 0,0267 | 0,0035 | 0,57 | 0,0305 | 0,0028 | 0,57 | 0,0305 | 0,0044 |
| S01- | Rothneusiedl | Güterzentrum Wien Süd | 0,18 | 0,0124 | 0,0006 | 0,18 | 0,0124 | 0,0010 | 0,25 | 0,0173 | 0,0015 | 0,25 | 0,0173 | 0,0023 | 0,37 | 0,0198 | 0,0018 | 0,37 | 0,0198 | 0,0029 |
| S01- | KN Rustenfeld | Rothneusiedl | 0,42 | 0,0290 | 0,0015 | 0,42 | 0,0290 | 0,0023 | 0,58 | 0,0406 | 0,0034 | 0,59 | 0,0406 | 0,0054 | 0,86 | 0,0464 | 0,0043 | 0,86 | 0,0464 | 0,0067 |
| S01- | Rannersdorf | KN Rustenfeld | 0,58 | 0,0407 | 0,0021 | 0,58 | 0,0407 | 0,0033 | 0,82 | 0,0569 | 0,0048 | 0,82 | 0,0569 | 0,0075 | 1,21 | 0,0651 | 0,0060 | 1,21 | 0,0651 | 0,0095 |
| S011 | Leopoldsdorf (B16) | KN Rustenfeld | 0,26 | 0,0180 | 0,0009 | 0,26 | 0,0180 | 0,0014 | 0,36 | 0,0252 | 0,0021 | 0,36 | 0,0252 | 0,0033 | 0,53 | 0,0288 | 0,0027 | 0,54 | 0,0288 | 0,0042 |
| S01- | Schwechat Süd | Rannersdorf | 0,46 | 0,0318 | 0,0016 | 0,46 | 0,0318 | 0,0026 | 0,64 | 0,0445 | 0,0037 | 0,64 | 0,0445 | 0,0059 | 0,94 | 0,0508 | 0,0047 | 0,95 | 0,0508 | 0,0074 |
| S01- | Schwechat Ost | Schwechat Süd | 0,26 | 0,0182 | 0,0009 | 0,26 | 0,0182 | 0,0015 | 0,37 | 0,0255 | 0,0021 | 0,37 | 0,0255 | 0,0034 | 0,54 | 0,0291 | 0,0027 | 0,54 | 0,0291 | 0,0042 |
| S01- | Mannswörth | Schwechat Ost | 0,28 | 0,0193 | 0,0010 | 0,28 | 0,0193 | 0,0015 | 0,39 | 0,0270 | 0,0023 | 0,39 | 0,0270 | 0,0036 | 0,57 | 0,0308 | 0,0029 | 0,57 | 0,0308 | 0,0045 |
| S01- | KN Schwechat | Mannswörth | 0,10 | 0,0072 | 0,0004 | 0,10 | 0,0072 | 0,0006 | 0,15 | 0,0101 | 0,0008 | 0,15 | 0,0101 | 0,0013 | 0,21 | 0,0116 | 0,0011 | 0,21 | 0,0116 | 0,0017 |
| S01- | Seyring | Angerner Straße | 0,97 | 0,0675 | 0,0034 | 0,97 | 0,0675 | 0,0054 | 1,36 | 0,0945 | 0,0079 | 1,36 | 0,0945 | 0,0125 | 2,00 | 0,1080 | 0,0100 | 2,01 | 0,1080 | 0,0157 |
| S01- | KN Eibesbrunn | Seyring | 0,81 | 0,0565 | 0,0029 | 0,81 | 0,0565 | 0,0045 | 1,14 | 0,0791 | 0,0066 | 1,14 | 0,0791 | 0,0104 | 1,68 | 0,0904 | 0,0084 | 1,68 | 0,0904 | 0,0131 |
| S01- | Hagenbrunn | KN Eibesbrunn | 0,64 | 0,0445 | 0,0023 | 0,64 | 0,0445 | 0,0036 | 0,90 | 0,0622 | 0,0052 | 0,90 | 0,0622 | 0,0082 | 1,32 | 0,0711 | 0,0066 | 1,32 | 0,0711 | 0,0104 |
| S01- | Korneuburg Nord | Hagenbrunn | 1,36 | 0,0951 | 0,0049 | 1,37 | 0,0951 | 0,0076 | 1,92 | 0,1331 | 0,0112 | 1,92 | 0,1331 | 0,0176 | 2,82 | 0,1522 | 0,0141 | 2,83 | 0,1522 | 0,0221 |
| S01- | Korneuburg West | Korneuburg Nord | 0,55 | 0,0386 | 0,0020 | 0,55 | 0,0386 | 0,0031 | 0,78 | 0,0540 | 0,0045 | 0,78 | 0,0540 | 0,0071 | 1,14 | 0,0617 | 0,0057 | 1,15 | 0,0617 | 0,0090 |
| S01- | KN Korneuburg | Korneuburg West | 0,18 | 0,0123 | 0,0006 | 0,18 | 0,0123 | 0,0010 | 0,25 | 0,0172 | 0,0014 | 0,25 | 0,0172 | 0,0023 | 0,37 | 0,0197 | 0,0018 | 0,37 | 0,0197 | 0,0029 |
| S02- | Gewerbepark Stadlau | Hirschstetten | 0,19 | 0,0132 | 0,0007 | 0,19 | 0,0132 | 0,0011 | 0,27 | 0,0185 | 0,0016 | 0,27 | 0,0185 | 0,0024 | 0,39 | 0,0212 | 0,0020 | 0,39 | 0,0212 | 0,0031 |
| S02- | Breitenleer Straße | Gewerbepark Stadlau | 0,11 | 0,0073 | 0,0004 | 0,11 | 0,0073 | 0,0006 | 0,15 | 0,0103 | 0,0009 | 0,15 | 0,0103 | 0,0014 | 0,22 | 0,0117 | 0,0011 | 0,22 | 0,0117 | 0,0017 |
| S02- | Rautenweg | Breitenleer Straße | 0,17 | 0,0122 | 0,0006 | 0,18 | 0,0122 | 0,0010 | 0,24 | 0,0170 | 0,0014 | 0,25 | 0,0170 | 0,0022 | 0,36 | 0,0195 | 0,0018 | 0,36 | 0,0195 | 0,0028 |
| S02- | Hermann Gebauer Straße | Rautenweg | 0,19 | 0,0134 | 0,0007 | 0,19 | 0,0134 | 0,0011 | 0,27 | 0,0187 | 0,0016 | 0,27 | 0,0187 | 0,0025 | 0,40 | 0,0214 | 0,0020 | 0,40 | 0,0214 | 0,0031 |
| S02- | Angerner Straße | Hermann Gebauer Straße | 0,69 | 0,0484 | 0,0025 | 0,70 | 0,0484 | 0,0039 | 0,97 | 0,0677 | 0,0057 | 0,98 | 0,0677 | 0,0089 | 1,44 | 0,0774 | 0,0072 | 1,44 | 0,0774 | 0,0113 |
| S03- | Stockerau Nord | KN Stockerau/West | 0,20 | 0,0137 | 0,0007 | 0,20 | 0,0137 | 0,0011 | 0,28 | 0,0191 | 0,0016 | 0,28 | 0,0191 | 0,0025 | 0,41 | 0,0219 | 0,0020 | 0,41 | 0,0219 | 0,0032 |
| S03- | Sierndorf | Stockerau Nord | 1,05 | 0,0735 | 0,0038 | 1,06 | 0,0735 | 0,0059 | 1,48 | 0,1029 | 0,0086 | 1,48 | 0,1029 | 0,0136 | 2,18 | 0,1176 | 0,0109 | 2,19 | 0,1176 | 0,0171 |
| S03- | Obermallebarn | Sierndorf | 0,71 | 0,0493 | 0,0025 | 0,71 | 0,0493 | 0,0040 | 0,99 | 0,0691 | 0,0058 | 1,00 | 0,0691 | 0,0091 | 1,46 | 0,0790 | 0,0073 | 1,47 | 0,0790 | 0,0115 |
| S03- | Göllersdorf | Obermallebarn | 0,94 | 0,0652 | 0,0033 | 0,94 | 0,0652 | 0,0052 | 1,31 | 0,0912 | 0,0077 | 1,32 | 0,0912 | 0,0120 | 1,93 | 0,1043 | 0,0097 | 1,94 | 0,1043 | 0,0152 |
| S03- | Großstelzendorf | Göllersdorf | 0,37 | 0,0261 | 0,0013 | 0,38 | 0,0261 | 0,0021 | 0,53 | 0,0365 | 0,0031 | 0,53 | 0,0365 | 0,0048 | 0,77 | 0,0418 | 0,0039 | 0,78 | 0,0418 | 0,0061 |
| S03- | Hollabrunn Süd | Großstelzendorf | 0,90 | 0,0628 | 0,0032 | 0,90 | 0,0628 | 0,0050 | 1,26 | 0,0879 | 0,0074 | 1,27 | 0,0879 | 0,0116 | 1,86 | 0,1004 | 0,0093 | 1,87 | 0,1004 | 0,0146 |
| S04- | Sigleß | KN Mattersburg | 0,47 | 0,0324 | 0,0017 | 0,47 | 0,0324 | 0,0026 | 0,65 | 0,0454 | 0,0038 | 0,66 | 0,0454 | 0,0060 | 0,96 | 0,0519 | 0,0048 | 0,97 | 0,0519 | 0,0076 |
| S04- | Bad Sauerbrunn | Sigleß | 1,09 | 0,0758 | 0,0039 | 1,09 | 0,0758 | 0,0061 | 1,53 | 0,1061 | 0,0089 | 1,53 | 0,1061 | 0,0140 | 2,25 | 0,1213 | 0,0112 | 2,26 | 0,1213 | 0,0177 |
| S04- | | | | | | | | | | | | | | | | | | | | |

| | | | | | | | | | | | | | | | | | | | | |
|------|-----------------------------------|-----------------------------------|------|--------|--------|------|--------|--------|-------|--------|--------|-------|--------|--------|-------|--------|--------|-------|--------|--------|
| S06- | Gloggnitz | Neunkirchen | 2,39 | 0,1667 | 0,0085 | 2,40 | 0,1667 | 0,0134 | 3,36 | 0,2334 | 0,0196 | 3,37 | 0,2334 | 0,0308 | 4,95 | 0,2668 | 0,0247 | 4,96 | 0,2668 | 0,0388 |
| S06- | Maria Schutz | Gloggnitz | 1,53 | 0,1063 | 0,0054 | 1,53 | 0,1063 | 0,0085 | 2,14 | 0,1488 | 0,0125 | 2,15 | 0,1488 | 0,0196 | 3,15 | 0,1700 | 0,0157 | 3,16 | 0,1700 | 0,0247 |
| S06- | Spital / Semmering | Maria Schutz | 1,29 | 0,0902 | 0,0046 | 1,30 | 0,0902 | 0,0072 | 1,82 | 0,1263 | 0,0106 | 1,82 | 0,1263 | 0,0167 | 2,68 | 0,1443 | 0,0134 | 2,68 | 0,1443 | 0,0210 |
| S06- | Mürzzuschlag Ost | Spital / Semmering | 1,08 | 0,0754 | 0,0039 | 1,08 | 0,0754 | 0,0061 | 1,52 | 0,1055 | 0,0089 | 1,52 | 0,1055 | 0,0139 | 2,24 | 0,1206 | 0,0112 | 2,24 | 0,1206 | 0,0175 |
| S06- | Mariazell, Mürzsteg, Mürzzuschlag | Mürzzuschlag Ost | 0,96 | 0,0668 | 0,0034 | 0,96 | 0,0668 | 0,0054 | 1,35 | 0,0935 | 0,0079 | 1,35 | 0,0935 | 0,0123 | 1,98 | 0,1069 | 0,0099 | 1,99 | 0,1069 | 0,0156 |
| S06- | Hönigsberg | Mariazell, Mürzsteg, Mürzzuschlag | 0,68 | 0,0476 | 0,0024 | 0,68 | 0,0476 | 0,0038 | 0,96 | 0,0667 | 0,0056 | 0,96 | 0,0667 | 0,0088 | 1,41 | 0,0762 | 0,0071 | 1,42 | 0,0762 | 0,0111 |
| S06- | Langenwang | Hönigsberg | 0,38 | 0,0263 | 0,0013 | 0,38 | 0,0263 | 0,0021 | 0,53 | 0,0369 | 0,0031 | 0,53 | 0,0369 | 0,0049 | 0,78 | 0,0422 | 0,0039 | 0,78 | 0,0422 | 0,0061 |
| S06- | Krieglach | Langenwang | 0,45 | 0,0313 | 0,0016 | 0,45 | 0,0313 | 0,0025 | 0,63 | 0,0438 | 0,0037 | 0,63 | 0,0438 | 0,0058 | 0,93 | 0,0501 | 0,0046 | 0,93 | 0,0501 | 0,0073 |
| S06- | Mitterdorf | Krieglach | 1,13 | 0,0791 | 0,0040 | 1,14 | 0,0791 | 0,0064 | 1,59 | 0,1107 | 0,0093 | 1,60 | 0,1107 | 0,0146 | 2,35 | 0,1265 | 0,0117 | 2,35 | 0,1265 | 0,0184 |
| S06- | Kindberg Ost | Mitterdorf | 1,15 | 0,0804 | 0,0041 | 1,16 | 0,0804 | 0,0065 | 1,62 | 0,1126 | 0,0095 | 1,62 | 0,1126 | 0,0149 | 2,39 | 0,1287 | 0,0119 | 2,39 | 0,1287 | 0,0187 |
| S06- | Kindberg West | Kindberg Ost | 0,25 | 0,0173 | 0,0009 | 0,25 | 0,0173 | 0,0014 | 0,35 | 0,0242 | 0,0020 | 0,35 | 0,0242 | 0,0032 | 0,51 | 0,0276 | 0,0026 | 0,51 | 0,0276 | 0,0040 |
| S06- | Kindberg Dörfel | Kindberg West | 0,25 | 0,0172 | 0,0009 | 0,25 | 0,0172 | 0,0014 | 0,35 | 0,0241 | 0,0020 | 0,35 | 0,0241 | 0,0032 | 0,51 | 0,0276 | 0,0026 | 0,51 | 0,0276 | 0,0040 |
| S06- | Allerheiligen Mürzhofen | Kindberg Dörfel | 0,56 | 0,0389 | 0,0020 | 0,56 | 0,0389 | 0,0031 | 0,78 | 0,0544 | 0,0046 | 0,79 | 0,0544 | 0,0072 | 1,15 | 0,0622 | 0,0058 | 1,16 | 0,0622 | 0,0090 |
| S06- | St. Marein | Allerheiligen Mürzhofen | 0,84 | 0,0584 | 0,0030 | 0,84 | 0,0584 | 0,0047 | 1,18 | 0,0817 | 0,0069 | 1,18 | 0,0817 | 0,0108 | 1,73 | 0,0934 | 0,0086 | 1,74 | 0,0934 | 0,0136 |
| S06- | Kapfenberg | St. Marein | 0,59 | 0,0414 | 0,0021 | 0,59 | 0,0414 | 0,0033 | 0,83 | 0,0579 | 0,0049 | 0,84 | 0,0579 | 0,0076 | 1,23 | 0,0662 | 0,0061 | 1,23 | 0,0662 | 0,0096 |
| S06- | KN Bruck/Mur | Kapfenberg | 1,11 | 0,0772 | 0,0039 | 1,11 | 0,0772 | 0,0062 | 1,56 | 0,1081 | 0,0091 | 1,56 | 0,1081 | 0,0143 | 2,29 | 0,1236 | 0,0114 | 2,30 | 0,1236 | 0,0180 |
| S06- | ASt Bruck/Mur | KN Bruck/Mur | 0,95 | 0,0663 | 0,0034 | 0,95 | 0,0663 | 0,0053 | 1,33 | 0,0928 | 0,0078 | 1,34 | 0,0928 | 0,0122 | 1,97 | 0,1060 | 0,0098 | 1,97 | 0,1060 | 0,0154 |
| S06- | Niklasdorf | ASt Bruck/Mur | 0,88 | 0,0612 | 0,0031 | 0,88 | 0,0612 | 0,0049 | 1,23 | 0,0857 | 0,0072 | 1,24 | 0,0857 | 0,0113 | 1,82 | 0,0979 | 0,0091 | 1,82 | 0,0979 | 0,0143 |
| S06- | Leoben Ost | Niklasdorf | 0,94 | 0,0653 | 0,0033 | 0,94 | 0,0653 | 0,0052 | 1,31 | 0,0914 | 0,0077 | 1,32 | 0,0914 | 0,0121 | 1,94 | 0,1045 | 0,0097 | 1,94 | 0,1045 | 0,0152 |
| S06- | Leoben West | Leoben Ost | 1,05 | 0,0731 | 0,0037 | 1,05 | 0,0731 | 0,0059 | 1,47 | 0,1024 | 0,0086 | 1,48 | 0,1024 | 0,0135 | 2,17 | 0,1170 | 0,0108 | 2,18 | 0,1170 | 0,0170 |
| S06- | KN St. Michael | Leoben West | 1,30 | 0,0905 | 0,0046 | 1,30 | 0,0905 | 0,0073 | 1,82 | 0,1268 | 0,0106 | 1,83 | 0,1268 | 0,0167 | 2,69 | 0,1449 | 0,0134 | 2,69 | 0,1449 | 0,0211 |
| S10- | Neumarkt | Unterweikersdorf | 1,32 | 0,0917 | 0,0047 | 1,32 | 0,0917 | 0,0074 | 1,85 | 0,1284 | 0,0108 | 1,85 | 0,1284 | 0,0169 | 2,72 | 0,1468 | 0,0136 | 2,73 | 0,1468 | 0,0214 |
| S10- | Kefermarkt | Neumarkt | 0,76 | 0,0527 | 0,0027 | 0,76 | 0,0527 | 0,0042 | 1,06 | 0,0738 | 0,0062 | 1,06 | 0,0738 | 0,0097 | 1,56 | 0,0843 | 0,0078 | 1,57 | 0,0843 | 0,0123 |
| S10- | Freistadt / Süd | Kefermarkt | 0,81 | 0,0567 | 0,0029 | 0,82 | 0,0567 | 0,0046 | 1,14 | 0,0793 | 0,0067 | 1,15 | 0,0793 | 0,0105 | 1,68 | 0,0907 | 0,0084 | 1,69 | 0,0907 | 0,0132 |
| S10- | Grünbach Sandl | Freistadt / Süd | 0,86 | 0,0600 | 0,0031 | 0,86 | 0,0600 | 0,0048 | 1,21 | 0,0839 | 0,0070 | 1,21 | 0,0839 | 0,0111 | 1,78 | 0,0959 | 0,0089 | 1,78 | 0,0959 | 0,0140 |
| S10- | Freistadt / Nord | Grünbach Sandl | 0,24 | 0,0165 | 0,0008 | 0,24 | 0,0165 | 0,0013 | 0,33 | 0,0231 | 0,0019 | 0,33 | 0,0231 | 0,0030 | 0,49 | 0,0263 | 0,0024 | 0,49 | 0,0263 | 0,0038 |
| S16- | Landeck West | Zams | 1,01 | 0,0701 | 0,0036 | 1,01 | 0,0701 | 0,0056 | 1,41 | 0,0981 | 0,0082 | 1,42 | 0,0981 | 0,0129 | 2,08 | 0,1121 | 0,0104 | 2,09 | 0,1121 | 0,0163 |
| S16- | Pians | Landeck West | 0,64 | 0,0449 | 0,0023 | 0,65 | 0,0449 | 0,0036 | 0,90 | 0,0628 | 0,0053 | 0,91 | 0,0628 | 0,0083 | 1,33 | 0,0718 | 0,0067 | 1,34 | 0,0718 | 0,0105 |
| S16- | Flirsch | Pians | 1,28 | 0,0890 | 0,0045 | 1,28 | 0,0890 | 0,0071 | 1,79 | 0,1245 | 0,0105 | 1,80 | 0,1245 | 0,0164 | 2,64 | 0,1423 | 0,0132 | 2,65 | 0,1423 | 0,0207 |
| S16- | Schnann am Arlberg | Flirsch | 0,80 | 0,0558 | 0,0029 | 0,80 | 0,0558 | 0,0045 | 1,12 | 0,0782 | 0,0066 | 1,13 | 0,0782 | 0,0103 | 1,66 | 0,0893 | 0,0083 | 1,66 | 0,0893 | 0,0130 |
| S16- | Pettneu | Schnann am Arlberg | 0,58 | 0,0406 | 0,0021 | 0,58 | 0,0406 | 0,0033 | 0,82 | 0,0568 | 0,0048 | 0,82 | 0,0568 | 0,0075 | 1,20 | 0,0649 | 0,0060 | 1,21 | 0,0649 | 0,0095 |
| S16- | St. Anton/Arlberg | Pettneu | 0,32 | 0,0226 | 0,0012 | 0,33 | 0,0226 | 0,0018 | 0,46 | 0,0316 | 0,0027 | 0,46 | 0,0316 | 0,0042 | 0,67 | 0,0362 | 0,0033 | 0,67 | 0,0362 | 0,0053 |
| S16- | Langen/Arlberg | St. Anton/Arlberg | 8,01 | 0,2199 | 0,0112 | 8,01 | 0,2199 | 0,0177 | 11,22 | 0,3079 | 0,0258 | 11,23 | 0,3079 | 0,0406 | 16,71 | 0,3519 | 0,0326 | 16,73 | 0,3519 | 0,0512 |
| S16- | Wald/Arlberg | Langen/Arlberg | 1,03 | 0,0720 | 0,0037 | 1,04 | 0,0720 | 0,0058 | 1,45 | 0,1008 | 0,0085 | 1,46 | 0,1008 | 0,0133 | 2,14 | 0,1153 | 0,0107 | 2,14 | 0,1153 | 0,0168 |
| S16- | Dalaas | Wald/Arlberg | 1,18 | 0,0820 | 0,0042 | 1,18 | 0,0820 | 0,0066 | 1,65 | 0,1149 | 0,0096 | 1,66 | 0,1149 | 0,0152 | 2,44 | 0,1313 | 0,0122 | 2,44 | 0,1313 | 0,0191 |
| S16- | Braz Ost | Dalaas | 0,67 | 0,0465 | 0,0024 | 0,67 | 0,0465 | 0,0037 | 0,94 | 0,0651 | 0,0055 | 0,94 | 0,0651 | 0,0086 | 1,38 | 0,0744 | 0,0069 | 1,38 | 0,0744 | 0,0108 |
| S16- | Braz West | Braz Ost | 0,52 | 0,0363 | 0,0019 | 0,52 | 0,0363 | 0,0029 | 0,73 | 0,0508 | 0,0043 | 0,73 | 0,0508 | 0,0067 | 1,08 | 0,0581 | 0,0054 | 1,08 | 0,0581 | 0,0085 |
| S16- | Bings | Braz West | 0,71 | 0,0492 | 0,0025 | 0,71 | 0,0492 | 0,0039 | 0,99 | 0,0688 | 0,0058 | 0,99 | 0,0688 | 0,0091 | 1,46 | 0,0787 | 0,0073 | 1,46 | 0,0787 | 0,0114 |
| S16- | Bludenz Montafon | Bings | 0,33 | 0,0233 | 0,0012 | 0,33 | 0,0233 | 0,0019 | 0,47 | 0,0326 | 0,0027 | 0,47 | 0,0326 | 0,0043 | 0,69 | 0,0372 | 0,0034 | 0,69 | 0,0372 | 0,0054 |
| S31- | Eisenstadt Süd | Eisenstadt Ost | 0,61 | 0,0422 | 0,0022 | 0,61 | 0,0422 | 0,0034 | 0,85 | 0,0591 | 0,0050 | 0,85 | 0,0591 | 0,0078 | 1,25 | 0,0675 | 0,0063 | 1,26 | 0,0675 | 0,0098 |
| S31- | Eisenstadt Mitte | Eisenstadt Süd | 0,23 | 0,0158 | 0,0008 | 0,23 | 0,0158 | 0,0013 | 0,32 | 0,0221 | 0,0019 | 0,32 | 0,0221 | 0,0029 | 0,47 | 0,0253 | 0,0023 | 0,47 | 0,0253 | 0,0037 |
| S31- | KN Eisenstadt | Eisenstadt Mitte | 0,37 | 0,0261 | 0,0013 | 0,37 | 0,0261 | 0,0021 | 0,52 | 0,0365 | 0,0031 | 0,53 | 0,0365 | 0,0048 | 0,77 | 0,0417 | 0,0039 | 0,78 | 0,0417 | 0,0061 |
| S31- | Wulkaprodersdorf | KN Eisenstadt | 0,50 | 0,0347 | 0,0018 | 0,50 | 0,0347 | 0,0028 | 0,70 | 0,0486 | 0,0041 | 0,70 | 0,0486 | 0,0064 | 1,03 | 0,0555 | 0,0051 | 1,03 | 0,0555 | 0,0081 |
| S31- | KN Mattersburg | Wulkaprodersdorf | 1,41 | 0,0985 | 0,0050 | 1,42 | 0,0985 | 0,0079 | 1,98 | 0,1379 | 0,0116 | 1,99 | 0,1379 | 0,0182 | 2,92 | 0,1576 | 0,0146 | 2,93 | 0,1576 | 0,0229 |
| S31- | Forchtenstein | KN Mattersburg | 1,02 | 0,0713 | 0,0036 | 1,03 | 0,0713 | 0,0057 | 1,44 | 0,0998 | 0,0084 | 1,44 | 0,0998 | 0,0132 | 2,12 | 0,1140 | 0,0106 | 2,12 | 0,1140 | 0,0166 |
| S31- | Sieggraben | Forchtenstein | 1,43 | 0,0996 | 0,0051 | 1,43 | 0,0996 | 0,0080 | 2,01 | 0,1394 | 0,0117 | 2,01 | 0,1394 | 0,0184 | 2,96 | 0,1594 | 0,0148 | 2,96 | 0,1594 | 0,0232 |
| S31- | Weppersdorf/Kobersdorf | Sieggraben | 1,72 | 0,1200 | 0,0061 | 1,73 | 0,1200 | 0,0096 | 2,42 | 0,1680 | 0,0141 | 2,42 | 0,1680 | 0,0222 | 3,56 | 0,1920 | 0,0178 | 3,57 | 0,1920 | 0,0279 |
| S31- | Weppersdorf/Markt St.Martin | Weppersdorf/Kobersdorf | 0,35 | 0,0246 | 0,0013 | 0,35 | 0,0246 | 0,0020 | 0,50 | 0,0345 | 0,0029 | 0,50 | 0,0345 | 0,0046 | 0,73 | 0,0394 | 0,0037 | 0,73 | 0,0394 | 0,0057 |
| S31- | Neutal | Weppersdorf/Markt St.Martin | 0,82 | 0,0570 | 0,0029 | 0,82 | 0,0570 | 0,0046 | 1,15 | 0,0797 | 0,0067 | 1,15 | 0,0797 | 0,0105 | 1,69 | 0,0911 | 0,0084 | 1,70 | 0,0911 | 0,0133 |
| S31- | Stoob Süd | Neutal | 0,71 | 0,0498 | 0,0025 | 0,72 | 0,0498 | 0,0040 | 1,00 | 0,0697 | 0,0058 | 1,01 | 0,0697 | 0,0092 | 1,48 | 0,0796 | 0,0074 | 1,48 | 0,0796 | 0,0116 |
| S31- | Oberpullendorf | Stoob Süd | 0,78 | 0,0543 | 0,0028 | 0,78 | 0,0543 | 0,0044 | 1,09 | 0,0760 | 0,0064 | 1,10 | 0,0760 | 0,0100 | 1,61 | 0,0869 | 0,0080 | 1,62 | 0,0869 | 0,0126 |
| S33- | St. Pölten Ost | KN St. Pölten | 0,42 | 0,0295 | 0,0015 | 0,42 | 0,0295 | 0,0024 | 0,59 | 0,0413 | 0,0035 | 0,60 | 0,0413 | 0,0054 | 0,88 | 0,0472 | 0,0044 | 0,88 | 0,0472 | 0,0069 |
| S33- | St. Pölten Nord | St. Pölten Ost | 0,75 | 0,0521 | 0,0027 | 0,75 | 0,0521 | 0,0042 | 1,05 | 0,0729 | 0,0061 | 1,05 | 0,0729 | 0,0096 | 1,55 | 0,0834 | 0,0077 | 1,55 | 0,0834 | 0,0121 |
| S33- | Herzenburg Süd | St. Pölten Nord | 0,79 | 0,0552 | 0,0028 | 0,79 | 0,0552 | 0,0044 | 1,11 | 0,0772 | 0,0065 | 1,11 | 0,0772 | 0,0102 | 1,64 | 0,0883 | 0,0082 | 1,64 | 0,0883 | 0,0128 |
| S33- | Herzenburg Stadt | Herzenburg Süd | 0,42 | 0,0295 | 0,0015 | 0,42 | 0,0295 | 0,0024 | 0,59 | 0,0412 | 0,0035 | 0,60 | 0,0412 | 0,0054 | 0,87 | 0,0471 | 0,0044 | 0,88 | 0,0471 | 0,0069 |
| S33- | Herzenburg Nord | Herzenburg Stadt | 0,23 | 0,0163 | 0,0008 | 0,23 | 0,0163 | 0,0013 | 0,33 | 0,0229 | 0,0019 | 0,33 | 0,0229 | 0,0030 | 0,48 | 0,0261 | 0,0024 | 0,49 | 0,0261 | 0,0038 |
| S33- | Traismauer Süd | Herzenburg Nord | 1,14 | 0,0795 | 0,0041 | 1,14 | 0,0795 | 0,0064 | 1,60 | 0 | | | | | | | | | | |

| | | | | | | | | | | | | | | | | | | | | |
|------|--------------------------|--------------------------|------|--------|--------|------|--------|--------|------|--------|--------|------|--------|--------|------|--------|--------|------|--------|--------|
| S36- | Zeltweg Ost Spielberg | Knittelfeld West | 0,18 | 0,0127 | 0,0006 | 0,18 | 0,0127 | 0,0010 | 0,26 | 0,0177 | 0,0015 | 0,26 | 0,0177 | 0,0023 | 0,38 | 0,0203 | 0,0019 | 0,38 | 0,0203 | 0,0030 |
| S36- | Zeltweg West | Zeltweg Ost Spielberg | 1,18 | 0,0825 | 0,0042 | 1,19 | 0,0825 | 0,0066 | 1,66 | 0,1155 | 0,0097 | 1,67 | 0,1155 | 0,0152 | 2,45 | 0,1320 | 0,0122 | 2,45 | 0,1320 | 0,0192 |
| S36- | Judenburg Ost Fohnsdorf | Zeltweg West | 0,60 | 0,0415 | 0,0021 | 0,60 | 0,0415 | 0,0033 | 0,84 | 0,0581 | 0,0049 | 0,84 | 0,0581 | 0,0077 | 1,23 | 0,0664 | 0,0061 | 1,23 | 0,0664 | 0,0097 |
| S36- | Judenburg West | Judenburg Ost Fohnsdorf | 0,92 | 0,0643 | 0,0033 | 0,93 | 0,0643 | 0,0052 | 1,30 | 0,0901 | 0,0076 | 1,30 | 0,0901 | 0,0119 | 1,91 | 0,1029 | 0,0095 | 1,91 | 0,1029 | 0,0150 |
| S36- | St. Georgen Ost | As B317 (prov.) | 0,10 | 0,0067 | 0,0003 | 0,10 | 0,0067 | 0,0005 | 0,14 | 0,0094 | 0,0008 | 0,14 | 0,0094 | 0,0012 | 0,20 | 0,0108 | 0,0010 | 0,20 | 0,0108 | 0,0016 |
| S36- | St. Georgen West | St. Georgen Ost | 0,18 | 0,0125 | 0,0006 | 0,18 | 0,0125 | 0,0010 | 0,25 | 0,0174 | 0,0015 | 0,25 | 0,0174 | 0,0023 | 0,37 | 0,0199 | 0,0018 | 0,37 | 0,0199 | 0,0029 |
| S37- | St. Veit Mitte / Brückl | St. Veit Nord | 0,56 | 0,0390 | 0,0020 | 0,56 | 0,0390 | 0,0031 | 0,79 | 0,0546 | 0,0046 | 0,79 | 0,0546 | 0,0072 | 1,16 | 0,0624 | 0,0058 | 1,16 | 0,0624 | 0,0091 |
| S37- | St. Veit Süd | St. Veit Mitte / Brückl | 0,48 | 0,0332 | 0,0017 | 0,48 | 0,0332 | 0,0027 | 0,67 | 0,0464 | 0,0039 | 0,67 | 0,0464 | 0,0061 | 0,98 | 0,0531 | 0,0049 | 0,99 | 0,0531 | 0,0077 |
| S37- | St. Veit Industriegebiet | St. Veit Süd | 0,36 | 0,0249 | 0,0013 | 0,36 | 0,0249 | 0,0020 | 0,50 | 0,0349 | 0,0029 | 0,50 | 0,0349 | 0,0046 | 0,74 | 0,0399 | 0,0037 | 0,74 | 0,0399 | 0,0058 |
| S37- | Maria Saal | St. Veit Industriegebiet | 1,26 | 0,0875 | 0,0045 | 1,26 | 0,0875 | 0,0070 | 1,76 | 0,1225 | 0,0103 | 1,77 | 0,1225 | 0,0162 | 2,60 | 0,1400 | 0,0130 | 2,60 | 0,1400 | 0,0204 |
| S37- | Karnburg | Maria Saal | 0,45 | 0,0312 | 0,0016 | 0,45 | 0,0312 | 0,0025 | 0,63 | 0,0437 | 0,0037 | 0,63 | 0,0437 | 0,0058 | 0,93 | 0,0500 | 0,0046 | 0,93 | 0,0500 | 0,0073 |
| S37- | Klagenfurt Nord | Karnburg | 0,39 | 0,0273 | 0,0014 | 0,39 | 0,0273 | 0,0022 | 0,55 | 0,0382 | 0,0032 | 0,55 | 0,0382 | 0,0050 | 0,81 | 0,0436 | 0,0040 | 0,81 | 0,0436 | 0,0064 |

| Road | Toll road section from | Toll road section to | EEV Cat 2 | | | | | | EEV Cat 3 | | | | | | EEV Cat 4 | | | | | |
|------|----------------------------|----------------------------|------------|--------|--------|-------|--------|--------|------------|--------|--------|-------|--------|--------|------------|--------|--------|-------|--------|--------|
| | | | Unit Price | | | | | | Unit Price | | | | | | Unit Price | | | | | |
| | | | Day | | | Night | | | Day | | | Night | | | Day | | | Night | | |
| | | | Sum | Air | Noise | Sum | Air | Noise | Sum | Air | Noise | Sum | Air | Noise | Sum | Air | Noise | Sum | Air | Noise |
| A01- | Wien Auhof | Preßbaum | 2,74 | 0,1908 | 0,0098 | 2,74 | 0,1908 | 0,0153 | 3,84 | 0,2672 | 0,0224 | 3,86 | 0,2672 | 0,0352 | 5,66 | 0,3053 | 0,0283 | 5,68 | 0,3053 | 0,0444 |
| A01- | Preßbaum | KN Steinhäusl | 1,55 | 0,1078 | 0,0055 | 1,55 | 0,1078 | 0,0087 | 2,17 | 0,1510 | 0,0127 | 2,18 | 0,1510 | 0,0199 | 3,20 | 0,1726 | 0,0160 | 3,21 | 0,1726 | 0,0251 |
| A01- | KN Steinhäusl | Altengbach | 0,91 | 0,0634 | 0,0032 | 0,91 | 0,0634 | 0,0051 | 1,28 | 0,0888 | 0,0075 | 1,28 | 0,0888 | 0,0117 | 1,88 | 0,1014 | 0,0094 | 1,89 | 0,1014 | 0,0148 |
| A01- | Altengbach | St. Christophen | 1,09 | 0,0756 | 0,0039 | 1,09 | 0,0756 | 0,0061 | 1,52 | 0,1059 | 0,0089 | 1,53 | 0,1059 | 0,0140 | 2,24 | 0,1210 | 0,0112 | 2,25 | 0,1210 | 0,0176 |
| A01- | St. Christophen | Böheimkirchen | 1,30 | 0,0907 | 0,0046 | 1,30 | 0,0907 | 0,0073 | 1,83 | 0,1270 | 0,0107 | 1,83 | 0,1270 | 0,0167 | 2,69 | 0,1451 | 0,0134 | 2,70 | 0,1451 | 0,0211 |
| A01- | Böheimkirchen | KN St. Pölten | 1,27 | 0,0887 | 0,0045 | 1,28 | 0,0887 | 0,0071 | 1,79 | 0,1242 | 0,0104 | 1,79 | 0,1242 | 0,0164 | 2,63 | 0,1419 | 0,0131 | 2,64 | 0,1419 | 0,0207 |
| A01- | KN St. Pölten | St. Pölten Süd | 0,90 | 0,0629 | 0,0032 | 0,90 | 0,0629 | 0,0051 | 1,27 | 0,0881 | 0,0074 | 1,27 | 0,0881 | 0,0116 | 1,87 | 0,1007 | 0,0093 | 1,87 | 0,1007 | 0,0147 |
| A01- | St. Pölten Süd | Loosdorf | 3,13 | 0,2182 | 0,0111 | 3,14 | 0,2182 | 0,0175 | 4,39 | 0,3055 | 0,0256 | 4,41 | 0,3055 | 0,0403 | 6,48 | 0,3491 | 0,0323 | 6,49 | 0,3491 | 0,0508 |
| A01- | Loosdorf | Melk | 1,15 | 0,0800 | 0,0041 | 1,15 | 0,0800 | 0,0064 | 1,61 | 0,1119 | 0,0094 | 1,62 | 0,1119 | 0,0148 | 2,37 | 0,1279 | 0,0118 | 2,38 | 0,1279 | 0,0186 |
| A01- | Melk | Pöchlarn | 2,03 | 0,1417 | 0,0072 | 2,04 | 0,1417 | 0,0114 | 2,85 | 0,1984 | 0,0167 | 2,86 | 0,1984 | 0,0262 | 4,21 | 0,2268 | 0,0210 | 4,22 | 0,2268 | 0,0330 |
| A01- | Pöchlarn | Ybbs Wieselburg | 1,88 | 0,1308 | 0,0067 | 1,88 | 0,1308 | 0,0105 | 2,63 | 0,1831 | 0,0154 | 2,64 | 0,1831 | 0,0242 | 3,88 | 0,2093 | 0,0194 | 3,89 | 0,2093 | 0,0305 |
| A01- | Ybbs Wieselburg | Amstetten Ost | 1,69 | 0,1175 | 0,0060 | 1,69 | 0,1175 | 0,0094 | 2,37 | 0,1645 | 0,0138 | 2,37 | 0,1645 | 0,0217 | 3,49 | 0,1881 | 0,0174 | 3,50 | 0,1881 | 0,0274 |
| A01- | Amstetten Ost | Amstetten West | 2,65 | 0,1849 | 0,0094 | 2,66 | 0,1849 | 0,0148 | 3,72 | 0,2588 | 0,0217 | 3,73 | 0,2588 | 0,0341 | 5,49 | 0,2958 | 0,0274 | 5,50 | 0,2958 | 0,0430 |
| A01- | Amstetten West | Oed | 1,86 | 0,1298 | 0,0066 | 1,87 | 0,1298 | 0,0104 | 2,61 | 0,1817 | 0,0153 | 2,62 | 0,1817 | 0,0240 | 3,85 | 0,2077 | 0,0192 | 3,86 | 0,2077 | 0,0302 |
| A01- | Oed | Haag | 2,01 | 0,1401 | 0,0072 | 2,01 | 0,1401 | 0,0112 | 2,82 | 0,1961 | 0,0165 | 2,83 | 0,1961 | 0,0259 | 4,16 | 0,2241 | 0,0208 | 4,17 | 0,2241 | 0,0326 |
| A01- | Haag | St. Valentin | 1,79 | 0,1247 | 0,0064 | 1,79 | 0,1247 | 0,0100 | 2,51 | 0,1746 | 0,0147 | 2,52 | 0,1746 | 0,0230 | 3,70 | 0,1996 | 0,0185 | 3,71 | 0,1996 | 0,0290 |
| A01- | St. Valentin | Enns Steyr | 0,76 | 0,0529 | 0,0027 | 0,76 | 0,0529 | 0,0042 | 1,06 | 0,0740 | 0,0062 | 1,07 | 0,0740 | 0,0098 | 1,57 | 0,0846 | 0,0078 | 1,57 | 0,0846 | 0,0123 |
| A01- | Enns Steyr | Enns West | 0,59 | 0,0410 | 0,0021 | 0,59 | 0,0410 | 0,0033 | 0,83 | 0,0574 | 0,0048 | 0,83 | 0,0574 | 0,0076 | 1,22 | 0,0656 | 0,0061 | 1,22 | 0,0656 | 0,0096 |
| A01- | Enns West | Asten St Florian | 0,46 | 0,0319 | 0,0016 | 0,46 | 0,0319 | 0,0026 | 0,64 | 0,0446 | 0,0037 | 0,64 | 0,0446 | 0,0059 | 0,95 | 0,0510 | 0,0047 | 0,95 | 0,0510 | 0,0074 |
| A01- | Asten St Florian | KN Linz | 1,75 | 0,1220 | 0,0098 | 1,75 | 0,1220 | 0,0098 | 2,46 | 0,1708 | 0,0143 | 2,46 | 0,1708 | 0,0225 | 3,62 | 0,1952 | 0,0181 | 3,63 | 0,1952 | 0,0284 |
| A01- | KN Linz | Ansfelden | 0,30 | 0,0206 | 0,0011 | 0,30 | 0,0206 | 0,0017 | 0,41 | 0,0288 | 0,0024 | 0,42 | 0,0288 | 0,0038 | 0,61 | 0,0329 | 0,0030 | 0,61 | 0,0329 | 0,0048 |
| A01- | Ansfelden | Traun | 0,65 | 0,0455 | 0,0023 | 0,65 | 0,0455 | 0,0037 | 0,92 | 0,0637 | 0,0053 | 0,92 | 0,0637 | 0,0084 | 1,35 | 0,0728 | 0,0067 | 1,35 | 0,0728 | 0,0106 |
| A01- | Traun | KN A1/A25 Passau Wels | 0,31 | 0,0214 | 0,0011 | 0,31 | 0,0214 | 0,0017 | 0,43 | 0,0300 | 0,0025 | 0,43 | 0,0300 | 0,0040 | 0,64 | 0,0342 | 0,0032 | 0,64 | 0,0342 | 0,0050 |
| A01- | KN A1/A25 Passau Wels | Allhaming | 1,42 | 0,0987 | 0,0050 | 1,42 | 0,0987 | 0,0079 | 1,99 | 0,1382 | 0,0116 | 1,99 | 0,1382 | 0,0182 | 2,93 | 0,1580 | 0,0146 | 2,94 | 0,1580 | 0,0230 |
| A01- | Allhaming | Sattledt | 2,36 | 0,1647 | 0,0084 | 2,37 | 0,1647 | 0,0132 | 3,32 | 0,2306 | 0,0194 | 3,33 | 0,2306 | 0,0304 | 4,89 | 0,2636 | 0,0244 | 4,90 | 0,2636 | 0,0384 |
| A01- | Sattledt | KN Voralpenkreuz | 0,30 | 0,0207 | 0,0011 | 0,30 | 0,0207 | 0,0017 | 0,42 | 0,0290 | 0,0024 | 0,42 | 0,0290 | 0,0038 | 0,62 | 0,0332 | 0,0031 | 0,62 | 0,0332 | 0,0048 |
| A01- | KN Voralpenkreuz | Eberstalzell | 0,86 | 0,0596 | 0,0030 | 0,86 | 0,0596 | 0,0048 | 1,20 | 0,0835 | 0,0070 | 1,20 | 0,0835 | 0,0110 | 1,77 | 0,0954 | 0,0088 | 1,77 | 0,0954 | 0,0139 |
| A01- | Eberstalzell | Vorchdorf | 1,29 | 0,0899 | 0,0046 | 1,29 | 0,0899 | 0,0072 | 1,81 | 0,1259 | 0,0106 | 1,82 | 0,1259 | 0,0166 | 2,67 | 0,1439 | 0,0133 | 2,68 | 0,1439 | 0,0209 |
| A01- | Vorchdorf | Laakirchen Ost | 1,13 | 0,0788 | 0,0040 | 1,13 | 0,0788 | 0,0063 | 1,59 | 0,1103 | 0,0093 | 1,59 | 0,1103 | 0,0146 | 2,34 | 0,1261 | 0,0117 | 2,34 | 0,1261 | 0,0183 |
| A01- | Laakirchen Ost | Laakirchen West | 0,71 | 0,0496 | 0,0025 | 0,71 | 0,0496 | 0,0040 | 1,00 | 0,0694 | 0,0058 | 1,00 | 0,0694 | 0,0092 | 1,47 | 0,0794 | 0,0073 | 1,48 | 0,0794 | 0,0115 |
| A01- | Laakirchen West | Regau | 1,40 | 0,0972 | 0,0050 | 1,40 | 0,0972 | 0,0078 | 1,96 | 0,1361 | 0,0114 | 1,96 | 0,1361 | 0,0180 | 2,89 | 0,1555 | 0,0144 | 2,89 | 0,1555 | 0,0226 |
| A01- | Regau | Schörfling | 1,83 | 0,1277 | 0,0065 | 1,84 | 0,1277 | 0,0103 | 2,57 | 0,1788 | 0,0150 | 2,58 | 0,1788 | 0,0236 | 3,79 | 0,2044 | 0,0189 | 3,80 | 0,2044 | 0,0297 |
| A01- | Schörfling | Seewalchen | 0,28 | 0,0198 | 0,0010 | 0,28 | 0,0198 | 0,0016 | 0,40 | 0,0277 | 0,0023 | 0,40 | 0,0277 | 0,0037 | 0,59 | 0,0317 | 0,0029 | 0,59 | 0,0317 | 0,0046 |
| A01- | Seewalchen | St. Georgen | 1,66 | 0,1158 | 0,0059 | 1,67 | 0,1158 | 0,0093 | 2,33 | 0,1621 | 0,0136 | 2,34 | 0,1621 | 0,0214 | 3,44 | 0,1853 | 0,0172 | 3,45 | 0,1853 | 0,0270 |
| A01- | St. Georgen | Oberwang | 2,22 | 0,1544 | 0,0079 | 2,22 | 0,1544 | 0,0124 | 3,11 | 0,2162 | 0,0181 | 3,12 | 0,2162 | 0,0285 | 4,58 | 0,2470 | 0,0229 | 4,60 | 0,2470 | 0,0360 |
| A01- | Oberwang | Mondsee | 2,04 | 0,1421 | 0,0073 | 2,04 | 0,1421 | 0,0114 | 2,86 | 0,1990 | 0,0167 | 2,87 | 0,1990 | 0,0262 | 4,22 | 0,2274 | 0,0211 | 4,23 | 0,2274 | 0,0331 |
| A01- | Mondsee | Thalgau | 1,88 | 0,1310 | 0,0067 | 1,88 | 0,1310 | 0,0105 | 2,64 | 0,1834 | 0,0154 | 2,65 | 0,1834 | 0,0242 | 3,89 | 0,2096 | 0,0194 | 3,90 | 0,2096 | 0,0305 |
| A01- | Thalgau | Wallersee | 1,43 | 0,0998 | 0,0051 | 1,44 | 0,0998 | 0,0080 | 2,01 | 0,1398 | 0,0117 | 2,02 | 0,1398 | 0,0184 | 2,96 | 0,1597 | 0,0148 | 2,97 | 0,1597 | 0,0232 |
| A01- | Wallersee | Salzburg Nord | 1,39 | 0,0966 | 0,0049 | 1,39 | 0,0966 | 0,0078 | 1,95 | 0,1353 | 0,0114 | 1,95 | 0,1353 | 0,0178 | 2,87 | 0,1546 | 0,0143 | 2,88 | 0,1546 | 0,0225 |
| A01- | Salzburg Nord | Salzburg Bergheim-West | 0,31 | 0,0218 | 0,0011 | 0,31 | 0,0218 | 0,0017 | 0,44 | 0,0305 | 0,0026 | 0,44 | 0,0305 | 0,0040 | 0,65 | 0,0349 | 0,0032 | 0,65 | 0,0349 | 0,0051 |
| A01- | Salzburg Bergheim-West | Messe | 0,15 | 0,0104 | 0,0005 | 0,15 | 0,0104 | 0,0008 | 0,21 | 0,0146 | 0,0012 | 0,21 | 0,0146 | 0,0019 | 0,31 | 0,0167 | 0,0015 | 0,31 | 0,0167 | 0,0024 |
| A01- | Messe | Salzburg Mitte Freilassing | 0,20 | 0,0139 | 0,0007 | 0,20 | 0,0139 | 0,0011 | 0,28 | 0,0194 | 0,0016 | 0,28 | 0,0194 | 0,0026 | 0,41 | 0,0222 | 0,0021 | 0,41 | 0,0222 | 0,0032 |
| A01- | Salzburg Mitte Freilassing | Kleßheim | 0,24 | 0,0170 | 0,0009 | 0,24 | 0,0170 | 0,0014 | 0,34 | 0,0238 | 0,0020 | 0,34 | 0,0238 | 0,0031 | 0,51 | 0,0272 | 0,0025 | 0,51 | 0,0272 | 0,0040 |
| A01- | Kleßheim | Siezenheim | 0,34 | 0,0236 | 0,0012 | 0,34 | 0,0236 | 0,0019 | 0,48 | 0,0330 | 0,0028 | 0,48 | 0,0330 | 0,0044 | 0,70 | 0,0378 | 0,0035 | 0,70 | 0,0378 | 0,0055 |
| A01- | Siezenheim | Flughafen | 0,17 | 0,0119 | 0,0006 | 0,17 | 0,0119 | 0,0010 | 0,24 | 0,0166 | 0,0014 | 0,24 | 0,0166 | 0,0022 | 0,35 | 0,0190 | 0,0018 | 0,35 | 0,0190 | 0,0028 |
| A01- | Flughafen | Wals Salzburg West | 0,21 | 0,0145 | 0,0007 | 0,21 | 0,0145 | 0,0012 | 0,29 | 0,0203 | 0,0017 | 0,29 | 0,0203 | 0,0027 | 0,43 | 0,0232 | 0,0021 | 0,43 | 0,0232 | 0,0034 |
| A01- | Wals Salzburg West | KN Salzburg | 0,31 | 0,0217 | 0,0011 | 0,31 | 0,0217 | 0,0017 | 0,44 | 0,0304 | 0,0026 | 0,44 | 0,0304 | 0,0040 | 0,64 | 0,0347 | 0,0032 | 0,65 | 0,0347 | 0,0051 |
| A01- | KN Salzburg | Staatsgrenze Walsberg | 0,53 | 0,0369 | 0,0019 | 0,53 | 0,0369 | 0,0030 | 0,74 | 0,0517 | 0,0043 | 0,75 | 0,0517 | 0,0068 | 1,09 | 0,0590 | 0,0055 | 1,10 | 0,0590 | 0,0086 |
| A02- | KN Wien Inzersdorf | KN Vösendorf | 0,66 | 0,0462 | 0,0024 | 0,66 | 0,0462 | 0,0037 | 0,93 | 0,0646 | 0,0054 | 0,93 | 0,0646 | 0,0085 | 1,37 | 0,0739 | 0,0068 | 1,37 | 0,0739 | 0,0108 |
| A02- | KN Vösendorf | Mödling | 0,45 | 0,0314 | 0,0016 | 0,45 | 0,0314 | 0,0025 | 0,63 | 0,0439 | 0,0037 | 0,63 | 0,0439 | 0,0058 | 0,93 | 0,0502 | 0,0 | | | |

| | | | | | | | | | | | | | | | | | | | | |
|------|----------------------------|----------------------------|------|--------|--------|------|--------|--------|------|--------|--------|------|--------|--------|------|--------|--------|------|--------|--------|
| A02- | Ilz Fürstenfeld | Sinabelkirchen | 2,21 | 0,1539 | 0,0079 | 2,21 | 0,1539 | 0,0124 | 3,10 | 0,2154 | 0,0181 | 3,11 | 0,2154 | 0,0284 | 4,57 | 0,2462 | 0,0228 | 4,58 | 0,2462 | 0,0358 |
| A02- | Sinabelkirchen | Gleisdorf Süd | 1,45 | 0,1014 | 0,0052 | 1,46 | 0,1014 | 0,0081 | 2,04 | 0,1419 | 0,0119 | 2,05 | 0,1419 | 0,0187 | 3,01 | 0,1622 | 0,0150 | 3,02 | 0,1622 | 0,0236 |
| A02- | Gleisdorf Süd | Gleisdorf West | 0,63 | 0,0440 | 0,0022 | 0,63 | 0,0440 | 0,0035 | 0,89 | 0,0616 | 0,0052 | 0,89 | 0,0616 | 0,0081 | 1,31 | 0,0704 | 0,0065 | 1,31 | 0,0704 | 0,0102 |
| A02- | Gleisdorf West | Laßnitzhöhe | 1,65 | 0,1153 | 0,0059 | 1,66 | 0,1153 | 0,0093 | 2,32 | 0,1614 | 0,0135 | 2,33 | 0,1614 | 0,0213 | 3,28 | 0,1845 | 0,0171 | 3,29 | 0,1845 | 0,0268 |
| A02- | Laßnitzhöhe | KN Graz Ost | 2,07 | 0,1442 | 0,0074 | 2,07 | 0,1442 | 0,0116 | 2,90 | 0,2019 | 0,0170 | 2,91 | 0,2019 | 0,0266 | 4,42 | 0,2308 | 0,0214 | 4,43 | 0,2308 | 0,0336 |
| A02- | KN Graz Ost | Graz Feldkirchen Flughafen | 0,74 | 0,0519 | 0,0027 | 0,75 | 0,0519 | 0,0042 | 1,05 | 0,0727 | 0,0061 | 1,05 | 0,0727 | 0,0096 | 1,54 | 0,0830 | 0,0077 | 1,54 | 0,0830 | 0,0121 |
| A02- | Graz Feldkirchen Flughafen | KN Graz West | 0,50 | 0,0347 | 0,0018 | 0,50 | 0,0347 | 0,0028 | 0,70 | 0,0486 | 0,0041 | 0,70 | 0,0486 | 0,0064 | 1,03 | 0,0556 | 0,0051 | 1,03 | 0,0556 | 0,0081 |
| A02- | KN Graz West | Unterpremstätten | 0,60 | 0,0418 | 0,0021 | 0,60 | 0,0418 | 0,0034 | 0,84 | 0,0585 | 0,0049 | 0,84 | 0,0585 | 0,0077 | 1,24 | 0,0668 | 0,0062 | 1,24 | 0,0668 | 0,0097 |
| A02- | Unterpremstätten | Lieboch | 0,93 | 0,0649 | 0,0033 | 0,93 | 0,0649 | 0,0052 | 1,31 | 0,0908 | 0,0076 | 1,31 | 0,0908 | 0,0120 | 1,93 | 0,1038 | 0,0096 | 1,93 | 0,1038 | 0,0151 |
| A02- | Lieboch | Mooskirchen | 1,28 | 0,0894 | 0,0046 | 1,29 | 0,0894 | 0,0072 | 1,80 | 0,1252 | 0,0105 | 1,81 | 0,1252 | 0,0165 | 2,65 | 0,1431 | 0,0133 | 2,66 | 0,1431 | 0,0208 |
| A02- | Mooskirchen | Steinberg | 1,33 | 0,0926 | 0,0047 | 1,33 | 0,0926 | 0,0074 | 1,86 | 0,1296 | 0,0109 | 1,87 | 0,1296 | 0,0171 | 2,75 | 0,1481 | 0,0137 | 2,76 | 0,1481 | 0,0216 |
| A02- | Steinberg | Modriach | 3,32 | 0,2314 | 0,0118 | 3,33 | 0,2314 | 0,0186 | 4,66 | 0,3240 | 0,0272 | 4,68 | 0,3240 | 0,0427 | 6,87 | 0,3702 | 0,0343 | 6,89 | 0,3702 | 0,0539 |
| A022 | KN Graz Ost | Puchwerk | 0,14 | 0,0097 | 0,0005 | 0,14 | 0,0097 | 0,0008 | 0,20 | 0,0136 | 0,0011 | 0,20 | 0,0136 | 0,0018 | 0,29 | 0,0155 | 0,0014 | 0,29 | 0,0155 | 0,0023 |
| A022 | Puchwerk | Graz Raaba | 0,20 | 0,0139 | 0,0007 | 0,20 | 0,0139 | 0,0011 | 0,28 | 0,0194 | 0,0016 | 0,28 | 0,0194 | 0,0026 | 0,41 | 0,0222 | 0,0021 | 0,41 | 0,0222 | 0,0032 |
| A022 | Graz Raaba | Graz Sternäckerweg | 0,29 | 0,0202 | 0,0010 | 0,29 | 0,0202 | 0,0016 | 0,41 | 0,0282 | 0,0024 | 0,41 | 0,0282 | 0,0037 | 0,60 | 0,0322 | 0,0030 | 0,60 | 0,0322 | 0,0047 |
| A02- | Modriach | Packsattel | 1,53 | 0,1066 | 0,0054 | 1,53 | 0,1066 | 0,0086 | 2,15 | 0,1492 | 0,0125 | 2,15 | 0,1492 | 0,0197 | 3,16 | 0,1705 | 0,0158 | 3,17 | 0,1705 | 0,0248 |
| A02- | Packsattel | Bad St. Leonhard | 1,86 | 0,1296 | 0,0066 | 1,86 | 0,1296 | 0,0104 | 2,61 | 0,1814 | 0,0152 | 2,62 | 0,1814 | 0,0239 | 3,85 | 0,2073 | 0,0192 | 3,86 | 0,2073 | 0,0302 |
| A02- | Bad St. Leonhard | Wolfsberg Nord | 2,19 | 0,1523 | 0,0078 | 2,19 | 0,1523 | 0,0122 | 3,07 | 0,2132 | 0,0179 | 3,08 | 0,2132 | 0,0281 | 4,52 | 0,2437 | 0,0226 | 4,53 | 0,2437 | 0,0355 |
| A02- | Wolfsberg Nord | Wolfsberg Süd | 0,62 | 0,0433 | 0,0022 | 0,62 | 0,0433 | 0,0035 | 0,87 | 0,0606 | 0,0051 | 0,87 | 0,0606 | 0,0080 | 1,28 | 0,0693 | 0,0064 | 1,29 | 0,0693 | 0,0101 |
| A02- | Wolfsberg Süd | St. Andrä | 1,83 | 0,1272 | 0,0065 | 1,83 | 0,1272 | 0,0102 | 2,56 | 0,1781 | 0,0149 | 2,57 | 0,1781 | 0,0235 | 3,77 | 0,2035 | 0,0188 | 3,79 | 0,2035 | 0,0296 |
| A02- | St. Andrä | Griffen | 1,77 | 0,1236 | 0,0063 | 1,78 | 0,1236 | 0,0099 | 2,49 | 0,1731 | 0,0145 | 2,50 | 0,1731 | 0,0228 | 3,67 | 0,1978 | 0,0183 | 3,68 | 0,1978 | 0,0288 |
| A02- | Griffen | Völkermarkt Ost | 0,90 | 0,0625 | 0,0032 | 0,90 | 0,0625 | 0,0050 | 1,26 | 0,0874 | 0,0073 | 1,26 | 0,0874 | 0,0115 | 1,85 | 0,0999 | 0,0093 | 1,86 | 0,0999 | 0,0145 |
| A02- | Völkermarkt Ost | Völkermarkt West | 2,07 | 0,1441 | 0,0074 | 2,07 | 0,1441 | 0,0116 | 2,90 | 0,2018 | 0,0169 | 2,91 | 0,2018 | 0,0266 | 4,28 | 0,2306 | 0,0214 | 4,29 | 0,2306 | 0,0336 |
| A02- | Völkermarkt West | Grafenstein | 1,98 | 0,1380 | 0,0070 | 1,98 | 0,1380 | 0,0111 | 2,78 | 0,1932 | 0,0162 | 2,79 | 0,1932 | 0,0255 | 4,09 | 0,2208 | 0,0204 | 4,11 | 0,2208 | 0,0321 |
| A02- | Grafenstein | Klagenfurt Ost | 1,27 | 0,0885 | 0,0045 | 1,27 | 0,0885 | 0,0071 | 1,78 | 0,1239 | 0,0104 | 1,79 | 0,1239 | 0,0163 | 2,63 | 0,1416 | 0,0131 | 2,63 | 0,1416 | 0,0206 |
| A02- | Klagenfurt Ost | Klagenfurt Flughafen | 0,64 | 0,0448 | 0,0023 | 0,64 | 0,0448 | 0,0036 | 0,90 | 0,0627 | 0,0053 | 0,90 | 0,0627 | 0,0083 | 1,33 | 0,0716 | 0,0066 | 1,33 | 0,0716 | 0,0104 |
| A02- | Klagenfurt Flughafen | Klagenfurt Nord | 0,71 | 0,0496 | 0,0025 | 0,71 | 0,0496 | 0,0040 | 1,00 | 0,0694 | 0,0058 | 1,00 | 0,0694 | 0,0092 | 1,47 | 0,0794 | 0,0073 | 1,48 | 0,0794 | 0,0115 |
| A02- | Klagenfurt Nord | Klagenfurt West | 1,23 | 0,0857 | 0,0044 | 1,23 | 0,0857 | 0,0069 | 1,73 | 0,1200 | 0,0101 | 1,73 | 0,1200 | 0,0158 | 2,54 | 0,1372 | 0,0127 | 2,55 | 0,1372 | 0,0200 |
| A02- | Klagenfurt West | Kruppendorf West | 0,49 | 0,0342 | 0,0017 | 0,49 | 0,0342 | 0,0027 | 0,69 | 0,0479 | 0,0040 | 0,69 | 0,0479 | 0,0063 | 1,01 | 0,0547 | 0,0051 | 1,02 | 0,0547 | 0,0080 |
| A02- | Kruppendorf West | Pörschach Ost | 0,59 | 0,0412 | 0,0021 | 0,59 | 0,0412 | 0,0033 | 0,83 | 0,0576 | 0,0048 | 0,83 | 0,0576 | 0,0076 | 1,22 | 0,0659 | 0,0061 | 1,23 | 0,0659 | 0,0096 |
| A02- | Pörschach Ost | Pörschach West | 0,92 | 0,0641 | 0,0033 | 0,92 | 0,0641 | 0,0051 | 1,29 | 0,0897 | 0,0075 | 1,30 | 0,0897 | 0,0118 | 1,90 | 0,1026 | 0,0095 | 1,91 | 0,1026 | 0,0149 |
| A02- | Pörschach West | Velden Ost | 0,68 | 0,0475 | 0,0024 | 0,68 | 0,0475 | 0,0038 | 0,96 | 0,0665 | 0,0056 | 0,96 | 0,0665 | 0,0088 | 1,41 | 0,0760 | 0,0070 | 1,41 | 0,0760 | 0,0111 |
| A02- | Velden Ost | Velden West | 0,73 | 0,0511 | 0,0026 | 0,74 | 0,0511 | 0,0041 | 1,03 | 0,0716 | 0,0060 | 1,03 | 0,0716 | 0,0094 | 1,52 | 0,0818 | 0,0076 | 1,52 | 0,0818 | 0,0119 |
| A02- | Velden West | Wernberg | 1,21 | 0,0845 | 0,0043 | 1,22 | 0,0845 | 0,0068 | 1,70 | 0,1183 | 0,0099 | 1,71 | 0,1183 | 0,0156 | 2,51 | 0,1352 | 0,0125 | 2,52 | 0,1352 | 0,0197 |
| A02- | Wernberg | KN Villach | 0,64 | 0,0449 | 0,0023 | 0,65 | 0,0449 | 0,0036 | 0,90 | 0,0629 | 0,0053 | 0,91 | 0,0629 | 0,0083 | 1,33 | 0,0719 | 0,0067 | 1,34 | 0,0719 | 0,0105 |
| A02- | KN Villach | Villach Faaker See | 0,50 | 0,0349 | 0,0018 | 0,50 | 0,0349 | 0,0028 | 0,70 | 0,0489 | 0,0041 | 0,71 | 0,0489 | 0,0065 | 1,04 | 0,0559 | 0,0052 | 1,04 | 0,0559 | 0,0081 |
| A02- | Villach Faaker See | Villach Warmbad | 1,15 | 0,0798 | 0,0041 | 1,15 | 0,0798 | 0,0064 | 1,61 | 0,1117 | 0,0094 | 1,61 | 0,1117 | 0,0147 | 2,37 | 0,1277 | 0,0118 | 2,38 | 0,1277 | 0,0186 |
| A02- | Villach Warmbad | Hermagor | 2,08 | 0,1447 | 0,0074 | 2,08 | 0,1447 | 0,0116 | 2,91 | 0,2025 | 0,0170 | 2,92 | 0,2025 | 0,0267 | 4,29 | 0,2315 | 0,0214 | 4,31 | 0,2315 | 0,0337 |
| A02- | Hermagor | Arnoldstein | 0,49 | 0,0345 | 0,0018 | 0,50 | 0,0345 | 0,0028 | 0,69 | 0,0482 | 0,0040 | 0,70 | 0,0482 | 0,0064 | 1,02 | 0,0551 | 0,0051 | 1,03 | 0,0551 | 0,0080 |
| A02- | Arnoldstein | Staatsgrenze Arnoldstein | 0,76 | 0,0528 | 0,0027 | 0,76 | 0,0528 | 0,0042 | 1,06 | 0,0740 | 0,0062 | 1,07 | 0,0740 | 0,0098 | 1,57 | 0,0845 | 0,0078 | 1,57 | 0,0845 | 0,0123 |
| | | | | | | | | | | | | | | | | | | | | |
| A03- | KN Guntramsdorf | Münchendorf/Achau | 0,20 | 0,0137 | 0,0007 | 0,20 | 0,0137 | 0,0011 | 0,28 | 0,0192 | 0,0016 | 0,28 | 0,0192 | 0,0025 | 0,41 | 0,0219 | 0,0020 | 0,41 | 0,0219 | 0,0032 |
| A03- | Münchendorf/Achau | Ebreichsdorf Nord | 0,83 | 0,0577 | 0,0029 | 0,83 | 0,0577 | 0,0046 | 1,16 | 0,0808 | 0,0068 | 1,17 | 0,0808 | 0,0107 | 1,71 | 0,0924 | 0,0086 | 1,72 | 0,0924 | 0,0134 |
| A03- | Ebreichsdorf Nord | Ebreichsdorf West | 0,68 | 0,0471 | 0,0024 | 0,68 | 0,0471 | 0,0038 | 0,95 | 0,0660 | 0,0055 | 0,95 | 0,0660 | 0,0087 | 1,40 | 0,0754 | 0,0070 | 1,40 | 0,0754 | 0,0110 |
| A03- | Ebreichsdorf West | Pottendorf | 0,89 | 0,0618 | 0,0032 | 0,89 | 0,0618 | 0,0050 | 1,25 | 0,0866 | 0,0073 | 1,25 | 0,0866 | 0,0114 | 1,83 | 0,0989 | 0,0092 | 1,84 | 0,0989 | 0,0144 |
| A03- | Pottendorf | Hornstein | 1,46 | 0,1015 | 0,0052 | 1,46 | 0,1015 | 0,0082 | 2,04 | 0,1421 | 0,0119 | 2,05 | 0,1421 | 0,0187 | 3,01 | 0,1624 | 0,0150 | 3,02 | 0,1624 | 0,0236 |
| A03- | Hornstein | Müllendorf | 0,95 | 0,0665 | 0,0034 | 0,96 | 0,0665 | 0,0053 | 1,34 | 0,0931 | 0,0078 | 1,34 | 0,0931 | 0,0123 | 1,97 | 0,1064 | 0,0099 | 1,98 | 0,1064 | 0,0155 |
| A03- | Müllendorf | KN Eisenstadt | 0,80 | 0,0556 | 0,0028 | 0,80 | 0,0556 | 0,0045 | 1,12 | 0,0779 | 0,0065 | 1,12 | 0,0779 | 0,0103 | 1,65 | 0,0890 | 0,0082 | 1,66 | 0,0890 | 0,0129 |
| A031 | KN Eisenstadt | Siegersdorf | 0,63 | 0,0438 | 0,0022 | 0,63 | 0,0438 | 0,0035 | 0,88 | 0,0614 | 0,0052 | 0,89 | 0,0614 | 0,0081 | 1,30 | 0,0701 | 0,0065 | 1,30 | 0,0701 | 0,0102 |
| | | | | | | | | | | | | | | | | | | | | |
| A041 | Stadionbrücke | KN Wien Prater | 0,12 | 0,0081 | 0,0004 | 0,12 | 0,0081 | 0,0006 | 0,16 | 0,0113 | 0,0009 | 0,16 | 0,0113 | 0,0015 | 0,24 | 0,0129 | 0,0012 | 0,24 | 0,0129 | 0,0019 |
| A04- | KN Wien Prater | Alt-Simmering | 0,25 | 0,0175 | 0,0009 | 0,25 | 0,0175 | 0,0014 | 0,35 | 0,0246 | 0,0021 | 0,35 | 0,0246 | 0,0032 | 0,52 | 0,0281 | 0,0026 | 0,52 | 0,0281 | 0,0041 |
| A04- | Alt-Simmering | Wien 7. Haidequerstraße | 0,19 | 0,0132 | 0,0007 | 0,19 | 0,0132 | 0,0011 | 0,27 | 0,0185 | 0,0016 | 0,27 | 0,0185 | 0,0024 | 0,39 | 0,0212 | 0,0020 | 0,39 | 0,0212 | 0,0031 |
| A04- | Wien 7. Haidequerstraße | Wien Simmeringer Haide | 0,36 | 0,0248 | 0,0013 | 0,36 | 0,0248 | 0,0020 | 0,50 | 0,0347 | 0,0029 | 0,50 | 0,0347 | 0,0046 | 0,73 | 0,0396 | 0,0037 | 0,74 | 0,0396 | 0,0058 |
| A04- | Wien Simmeringer Haide | KN Schwechat | 0,72 | 0,0499 | 0,0025 | 0,72 | 0,0499 | 0,0040 | 1,00 | 0,0698 | 0,0059 | 1,01 | 0,0698 | 0,0092 | 1,48 | 0,0798 | 0,0074 | 1,48 | 0,0798 | 0,0116 |
| A04- | KN Schwechat | Flughafen Wien Schwechat | 1,03 | 0,0720 | 0,0037 | 1,04 | 0,0720 | 0,0058 | 1,45 | 0,1008 | 0,0085 | 1,46 | 0,1008 | 0,0133 | 2,14 | 0,1153 | 0,0107 | 2,14 | 0,1153 | 0,0168 |
| A04- | Flughafen Wien Schwechat | Fischamend | 1,16 | 0,0807 | 0,0041 | 1,16 | 0,0807 | 0,0065 | 1,62 | 0,1129 | 0,0095 | 1,63 | 0,1129 | 0,0149 | 2,39 | 0,1290 | 0,0120 | 2,40 | 0,1290 | 0,0188 |
| A04- | Fischamend | Bruck/Leitha West | 2,54 | 0,1769 | 0,0090 | 2,54 | 0,1769 | 0,0142 | 3,56 | 0,2476 | 0,0208 | 3,57 | 0,2476 | 0,0327 | 5,25 | 0,28 | | | | |

| | | | | | | | | | | | | | | | | | | | | |
|------|----------------------------------|----------------------------------|-------|--------|--------|-------|--------|--------|-------|--------|--------|-------|--------|--------|-------|--------|--------|-------|--------|--------|
| A05- | Großkrut | Poysdorf Nord | 1,35 | 0,0939 | 0,0048 | 1,35 | 0,0939 | 0,0075 | 1,89 | 0,1314 | 0,0110 | 1,90 | 0,1314 | 0,0173 | 2,79 | 0,1502 | 0,0139 | 2,79 | 0,1502 | 0,0219 |
| A06- | KN Bruckneudorf | Potzneusiedl | 1,71 | 0,1189 | 0,0061 | 1,71 | 0,1189 | 0,0095 | 2,39 | 0,1665 | 0,0140 | 2,40 | 0,1665 | 0,0220 | 3,53 | 0,1903 | 0,0176 | 3,54 | 0,1903 | 0,0277 |
| A06- | Potzneusiedl | Gattendorf | 0,74 | 0,0516 | 0,0026 | 0,74 | 0,0516 | 0,0041 | 1,04 | 0,0723 | 0,0061 | 1,04 | 0,0723 | 0,0095 | 1,53 | 0,0826 | 0,0076 | 1,54 | 0,0826 | 0,0120 |
| A06- | Gattendorf | Kittsee | 1,24 | 0,0863 | 0,0044 | 1,24 | 0,0863 | 0,0069 | 1,74 | 0,1209 | 0,0101 | 1,74 | 0,1209 | 0,0159 | 2,56 | 0,1381 | 0,0128 | 2,57 | 0,1381 | 0,0201 |
| A06- | Kittsee | Staatsgrenze Kittsee | 0,63 | 0,0439 | 0,0022 | 0,63 | 0,0439 | 0,0035 | 0,88 | 0,0614 | 0,0052 | 0,89 | 0,0614 | 0,0081 | 1,30 | 0,0702 | 0,0065 | 1,31 | 0,0702 | 0,0102 |
| A07- | KN Linz | Linz Franzosenhausweg | 0,44 | 0,0309 | 0,0016 | 0,44 | 0,0309 | 0,0025 | 0,62 | 0,0433 | 0,0036 | 0,63 | 0,0433 | 0,0057 | 0,92 | 0,0495 | 0,0046 | 0,92 | 0,0495 | 0,0072 |
| A07- | Linz Franzosenhausweg | Linz Salzburger Straße Neue Welt | 0,39 | 0,0270 | 0,0014 | 0,39 | 0,0270 | 0,0022 | 0,54 | 0,0378 | 0,0032 | 0,55 | 0,0378 | 0,0050 | 0,80 | 0,0432 | 0,0040 | 0,80 | 0,0432 | 0,0063 |
| A07- | Linz Salzburger Straße Neue Welt | Muldenstraße Bindermichl | 0,27 | 0,0187 | 0,0010 | 0,27 | 0,0187 | 0,0015 | 0,38 | 0,0262 | 0,0022 | 0,38 | 0,0262 | 0,0035 | 0,56 | 0,0300 | 0,0028 | 0,56 | 0,0300 | 0,0044 |
| A07- | Muldenstraße Bindermichl | Leonding Linz Zentrum | 0,13 | 0,0091 | 0,0005 | 0,13 | 0,0091 | 0,0007 | 0,18 | 0,0127 | 0,0011 | 0,18 | 0,0127 | 0,0017 | 0,27 | 0,0146 | 0,0013 | 0,27 | 0,0146 | 0,0021 |
| A07- | Leonding Linz Zentrum | Linz Wiener Straße | 0,18 | 0,0128 | 0,0007 | 0,18 | 0,0128 | 0,0010 | 0,26 | 0,0179 | 0,0015 | 0,26 | 0,0179 | 0,0024 | 0,38 | 0,0205 | 0,0019 | 0,38 | 0,0205 | 0,0030 |
| A07- | Linz Wiener Straße | Linz VOEST | 0,17 | 0,0119 | 0,0006 | 0,17 | 0,0119 | 0,0010 | 0,24 | 0,0166 | 0,0014 | 0,24 | 0,0166 | 0,0022 | 0,35 | 0,0190 | 0,0018 | 0,35 | 0,0190 | 0,0028 |
| A07- | Linz VOEST | Linz Industriezeile | 0,13 | 0,0093 | 0,0005 | 0,13 | 0,0093 | 0,0007 | 0,19 | 0,0131 | 0,0011 | 0,19 | 0,0131 | 0,0017 | 0,28 | 0,0149 | 0,0014 | 0,28 | 0,0149 | 0,0022 |
| A07- | Linz Industriezeile | Linz Prinz Eugenstraße | 0,21 | 0,0148 | 0,0008 | 0,21 | 0,0148 | 0,0012 | 0,30 | 0,0207 | 0,0017 | 0,30 | 0,0207 | 0,0027 | 0,44 | 0,0237 | 0,0022 | 0,44 | 0,0237 | 0,0034 |
| A07- | Linz Prinz Eugenstraße | Linz Hafenstraße | 0,40 | 0,0277 | 0,0014 | 0,40 | 0,0277 | 0,0022 | 0,56 | 0,0388 | 0,0033 | 0,56 | 0,0388 | 0,0051 | 0,82 | 0,0443 | 0,0041 | 0,82 | 0,0443 | 0,0065 |
| A07- | Linz Hafenstraße | Linz Urfa hr | 0,16 | 0,0109 | 0,0006 | 0,16 | 0,0109 | 0,0009 | 0,22 | 0,0152 | 0,0013 | 0,22 | 0,0152 | 0,0020 | 0,32 | 0,0174 | 0,0016 | 0,32 | 0,0174 | 0,0025 |
| A07- | Linz Urfa hr | Linz Dornach | 0,38 | 0,0264 | 0,0013 | 0,38 | 0,0264 | 0,0021 | 0,53 | 0,0369 | 0,0031 | 0,53 | 0,0369 | 0,0049 | 0,78 | 0,0422 | 0,0039 | 0,78 | 0,0422 | 0,0061 |
| A07- | Linz Dornach | Treffling | 0,83 | 0,0580 | 0,0030 | 0,83 | 0,0580 | 0,0047 | 1,17 | 0,0812 | 0,0068 | 1,17 | 0,0812 | 0,0107 | 1,72 | 0,0928 | 0,0086 | 1,73 | 0,0928 | 0,0135 |
| A07- | Treffling | Gallneukirchen | 0,63 | 0,0437 | 0,0022 | 0,63 | 0,0437 | 0,0035 | 0,88 | 0,0612 | 0,0051 | 0,88 | 0,0612 | 0,0081 | 1,30 | 0,0699 | 0,0065 | 1,30 | 0,0699 | 0,0102 |
| A07- | Gallneukirchen | Engerwitzdorf | 0,56 | 0,0389 | 0,0020 | 0,56 | 0,0389 | 0,0031 | 0,78 | 0,0545 | 0,0046 | 0,79 | 0,0545 | 0,0072 | 1,16 | 0,0623 | 0,0058 | 1,16 | 0,0623 | 0,0091 |
| A07- | Engerwitzdorf | Unterweikersdorf | 0,72 | 0,0499 | 0,0026 | 0,72 | 0,0499 | 0,0040 | 1,01 | 0,0699 | 0,0059 | 1,01 | 0,0699 | 0,0092 | 1,48 | 0,0799 | 0,0074 | 1,49 | 0,0799 | 0,0116 |
| A08- | KN Voralpenkreuz | Wels West | 2,20 | 0,1531 | 0,0078 | 2,20 | 0,1531 | 0,0123 | 3,08 | 0,2144 | 0,0180 | 3,09 | 0,2144 | 0,0283 | 4,54 | 0,2450 | 0,0227 | 4,56 | 0,2450 | 0,0357 |
| A08- | Wels West | KN Wels | 0,78 | 0,0540 | 0,0028 | 0,78 | 0,0540 | 0,0043 | 1,09 | 0,0756 | 0,0063 | 1,09 | 0,0756 | 0,0100 | 1,60 | 0,0864 | 0,0080 | 1,61 | 0,0864 | 0,0126 |
| A08- | KN Wels | Pichl/Bad Schallerbach | 0,85 | 0,0594 | 0,0030 | 0,85 | 0,0594 | 0,0048 | 1,20 | 0,0832 | 0,0070 | 1,20 | 0,0832 | 0,0110 | 1,76 | 0,0951 | 0,0088 | 1,77 | 0,0951 | 0,0138 |
| A08- | Pichl/Bad Schallerbach | Meggenhofen Gallspace | 2,16 | 0,1502 | 0,0077 | 2,16 | 0,1502 | 0,0121 | 3,02 | 0,2102 | 0,0176 | 3,03 | 0,2102 | 0,0277 | 4,46 | 0,2403 | 0,0223 | 4,47 | 0,2403 | 0,0350 |
| A08- | Meggenhofen Gallspace | Haag am Hausruck | 2,35 | 0,1637 | 0,0084 | 2,35 | 0,1637 | 0,0131 | 3,30 | 0,2291 | 0,0192 | 3,31 | 0,2291 | 0,0302 | 4,86 | 0,2619 | 0,0243 | 4,87 | 0,2619 | 0,0381 |
| A08- | Haag am Hausruck | Ried im Innkreis | 2,14 | 0,1494 | 0,0076 | 2,15 | 0,1494 | 0,0120 | 3,01 | 0,2091 | 0,0176 | 3,02 | 0,2091 | 0,0276 | 4,43 | 0,2390 | 0,0221 | 4,45 | 0,2390 | 0,0348 |
| A08- | Ried im Innkreis | Ort im Innkreis | 2,30 | 0,1603 | 0,0082 | 2,31 | 0,1603 | 0,0129 | 3,23 | 0,2244 | 0,0188 | 3,24 | 0,2244 | 0,0296 | 4,76 | 0,2565 | 0,0238 | 4,77 | 0,2565 | 0,0373 |
| A08- | Ort im Innkreis | Schärding Suben | 1,74 | 0,1210 | 0,0062 | 1,74 | 0,1210 | 0,0097 | 2,44 | 0,1694 | 0,0142 | 2,44 | 0,1694 | 0,0223 | 3,59 | 0,1936 | 0,0179 | 3,60 | 0,1936 | 0,0282 |
| A08- | Schärding Suben | Staatsgrenze Suben | 0,44 | 0,0306 | 0,0016 | 0,44 | 0,0306 | 0,0025 | 0,62 | 0,0428 | 0,0036 | 0,62 | 0,0428 | 0,0056 | 0,91 | 0,0489 | 0,0045 | 0,91 | 0,0489 | 0,0071 |
| A09- | KN Voralpenkreuz | Ried im Traunkreis | 1,08 | 0,0754 | 0,0039 | 1,08 | 0,0754 | 0,0061 | 1,52 | 0,1055 | 0,0089 | 1,52 | 0,1055 | 0,0139 | 2,24 | 0,1206 | 0,0112 | 2,24 | 0,1206 | 0,0175 |
| A09- | Ried im Traunkreis | Inzersdorf Kirchdorf | 2,03 | 0,1414 | 0,0072 | 2,03 | 0,1414 | 0,0114 | 2,85 | 0,1979 | 0,0166 | 2,86 | 0,1979 | 0,0261 | 4,20 | 0,2262 | 0,0209 | 4,21 | 0,2262 | 0,0329 |
| A09- | Inzersdorf Kirchdorf | Klaus | 2,47 | 0,1722 | 0,0088 | 2,48 | 0,1722 | 0,0138 | 3,47 | 0,2411 | 0,0202 | 3,48 | 0,2411 | 0,0318 | 5,11 | 0,2755 | 0,0255 | 5,13 | 0,2755 | 0,0401 |
| A09- | Klaus | St. Pankratz | 1,57 | 0,1095 | 0,0056 | 1,57 | 0,1095 | 0,0088 | 2,20 | 0,1532 | 0,0129 | 2,21 | 0,1532 | 0,0202 | 3,25 | 0,1751 | 0,0162 | 3,26 | 0,1751 | 0,0255 |
| A09- | St. Pankratz | Roßleiten Windischgarsten | 2,19 | 0,1527 | 0,0078 | 2,20 | 0,1527 | 0,0123 | 3,08 | 0,2138 | 0,0179 | 3,09 | 0,2138 | 0,0282 | 4,53 | 0,2444 | 0,0226 | 4,55 | 0,2444 | 0,0356 |
| A09- | Roßleiten Windischgarsten | Gleinkerau | 1,03 | 0,0718 | 0,0037 | 1,03 | 0,0718 | 0,0058 | 1,45 | 0,1005 | 0,0084 | 1,45 | 0,1005 | 0,0133 | 2,13 | 0,1149 | 0,0106 | 2,14 | 0,1149 | 0,0167 |
| A09- | Gleinkerau | Spital am Pyhrn | 0,78 | 0,0541 | 0,0028 | 0,78 | 0,0541 | 0,0043 | 1,09 | 0,0758 | 0,0064 | 1,09 | 0,0758 | 0,0100 | 1,61 | 0,0866 | 0,0080 | 1,61 | 0,0866 | 0,0126 |
| A09- | Spital am Pyhrn | Ardning / Admont | 4,27 | 0,1378 | 0,0070 | 4,27 | 0,1378 | 0,0113 | 5,98 | 0,1929 | 0,0162 | 5,99 | 0,1929 | 0,0254 | 8,90 | 0,2204 | 0,0204 | 8,91 | 0,2204 | 0,0321 |
| A09- | Ardning / Admont | Liezen | 0,45 | 0,0314 | 0,0016 | 0,45 | 0,0314 | 0,0025 | 0,63 | 0,0440 | 0,0037 | 0,63 | 0,0440 | 0,0058 | 0,93 | 0,0502 | 0,0047 | 0,93 | 0,0502 | 0,0073 |
| A09- | Liezen | Rottenmann | 0,94 | 0,0656 | 0,0034 | 0,94 | 0,0656 | 0,0053 | 1,32 | 0,0919 | 0,0077 | 1,33 | 0,0919 | 0,0121 | 1,95 | 0,1050 | 0,0097 | 1,95 | 0,1050 | 0,0153 |
| A09- | Rottenmann | Trieben | 2,35 | 0,1636 | 0,0084 | 2,35 | 0,1636 | 0,0131 | 3,29 | 0,2290 | 0,0192 | 3,30 | 0,2290 | 0,0302 | 4,85 | 0,2617 | 0,0242 | 4,87 | 0,2617 | 0,0381 |
| A09- | Trieben | Treglwang | 1,91 | 0,1330 | 0,0068 | 1,91 | 0,1330 | 0,0107 | 2,68 | 0,1862 | 0,0156 | 2,69 | 0,1862 | 0,0246 | 3,95 | 0,2128 | 0,0197 | 3,96 | 0,2128 | 0,0310 |
| A09- | Treglwang | Kalwang | 2,56 | 0,1787 | 0,0091 | 2,57 | 0,1787 | 0,0143 | 3,60 | 0,2502 | 0,0210 | 3,61 | 0,2502 | 0,0330 | 5,30 | 0,2859 | 0,0265 | 5,32 | 0,2859 | 0,0416 |
| A09- | Kalwang | Mautern | 1,19 | 0,0832 | 0,0043 | 1,20 | 0,0832 | 0,0067 | 1,68 | 0,1165 | 0,0098 | 1,68 | 0,1165 | 0,0154 | 2,47 | 0,1331 | 0,0123 | 2,48 | 0,1331 | 0,0194 |
| A09- | Mautern | Kammern | 1,34 | 0,0936 | 0,0048 | 1,35 | 0,0936 | 0,0075 | 1,89 | 0,1311 | 0,0110 | 1,89 | 0,1311 | 0,0173 | 2,78 | 0,1498 | 0,0139 | 2,79 | 0,1498 | 0,0218 |
| A09- | Kammern | Traboch | 1,40 | 0,0979 | 0,0050 | 1,41 | 0,0979 | 0,0079 | 1,97 | 0,1370 | 0,0115 | 1,98 | 0,1370 | 0,0181 | 2,90 | 0,1566 | 0,0145 | 2,91 | 0,1566 | 0,0228 |
| A09- | Traboch | Terminal St. Michael | 0,28 | 0,0192 | 0,0010 | 0,28 | 0,0192 | 0,0015 | 0,39 | 0,0269 | 0,0023 | 0,39 | 0,0269 | 0,0035 | 0,57 | 0,0308 | 0,0028 | 0,57 | 0,0308 | 0,0045 |
| A09- | Terminal St. Michael | KN St. Michael | 0,52 | 0,0360 | 0,0018 | 0,52 | 0,0360 | 0,0029 | 0,73 | 0,0504 | 0,0042 | 0,73 | 0,0504 | 0,0067 | 1,07 | 0,0576 | 0,0053 | 1,07 | 0,0576 | 0,0084 |
| A09- | KN St. Michael | Übelbach | 10,40 | 0,3356 | 0,0171 | 10,41 | 0,3356 | 0,0269 | 14,58 | 0,4698 | 0,0394 | 14,60 | 0,4698 | 0,0620 | 21,69 | 0,5369 | 0,0497 | 21,71 | 0,5369 | 0,0781 |
| A09- | Übelbach | KN Peggau Deutschfeistritz | 1,59 | 0,1110 | 0,0057 | 1,60 | 0,1110 | 0,0089 | 2,23 | 0,1554 | 0,0130 | 2,24 | 0,1554 | 0,0205 | 3,29 | 0,1776 | 0,0164 | 3,30 | 0,1776 | 0,0258 |
| A09- | KN Peggau Deutschfeistritz | Gratkorn Nord | 0,75 | 0,0526 | 0,0027 | 0,76 | 0,0526 | 0,0042 | 1,06 | 0,0736 | 0,0062 | 1,06 | 0,0736 | 0,0097 | 1,56 | 0,0841 | 0,0078 | 1,56 | 0,0841 | 0,0122 |
| A09- | Gratkorn Nord | Gratkorn Süd | 0,83 | 0,0577 | 0,0030 | 0,83 | 0,0577 | 0,0046 | 1,16 | 0,0808 | 0,0068 | 1,17 | 0,0808 | 0,0107 | 1,71 | 0,0924 | 0,0086 | 1,72 | 0,0924 | |

| | | | | | | | | | | | | | | | | | | | | |
|------|--|---|-------|--------|--------|-------|--------|--------|-------|--------|--------|-------|--------|--------|-------|--------|--------|-------|--------|--------|
| A10- | Hallein | Kuchl | 1,15 | 0,0802 | 0,0041 | 1,15 | 0,0802 | 0,0064 | 1,61 | 0,1123 | 0,0094 | 1,62 | 0,1123 | 0,0148 | 2,38 | 0,1283 | 0,0119 | 2,39 | 0,1283 | 0,0187 |
| A10- | Kuchl | Golling / Abtenau | 1,16 | 0,0806 | 0,0041 | 1,16 | 0,0806 | 0,0065 | 1,62 | 0,1129 | 0,0095 | 1,63 | 0,1129 | 0,0149 | 2,39 | 0,1290 | 0,0119 | 2,40 | 0,1290 | 0,0188 |
| A10- | Golling / Abtenau | Paß Lueg | 1,21 | 0,0841 | 0,0043 | 1,21 | 0,0841 | 0,0068 | 1,69 | 0,1178 | 0,0099 | 1,70 | 0,1178 | 0,0155 | 2,50 | 0,1346 | 0,0125 | 2,50 | 0,1346 | 0,0196 |
| A10- | Paß Lueg | Werfen | 1,72 | 0,1198 | 0,0061 | 1,72 | 0,1198 | 0,0096 | 2,41 | 0,1678 | 0,0141 | 2,42 | 0,1678 | 0,0221 | 3,56 | 0,1917 | 0,0178 | 3,57 | 0,1917 | 0,0279 |
| A10- | Werfen | Pfarrwerfen / Werfen | 0,22 | 0,0156 | 0,0008 | 0,22 | 0,0156 | 0,0013 | 0,31 | 0,0219 | 0,0018 | 0,32 | 0,0219 | 0,0029 | 0,46 | 0,0250 | 0,0023 | 0,46 | 0,0250 | 0,0036 |
| A10- | Pfarrwerfen / Werfen | KN Pongau | 0,49 | 0,0339 | 0,0017 | 0,49 | 0,0339 | 0,0027 | 0,68 | 0,0475 | 0,0040 | 0,68 | 0,0475 | 0,0063 | 1,01 | 0,0542 | 0,0050 | 1,01 | 0,0542 | 0,0079 |
| A101 | KN Pongau | Bischofshofen Mühlbach a. Hochkönig | 0,72 | 0,0504 | 0,0026 | 0,72 | 0,0504 | 0,0040 | 1,02 | 0,0706 | 0,0059 | 1,02 | 0,0706 | 0,0093 | 1,50 | 0,0807 | 0,0075 | 1,50 | 0,0807 | 0,0117 |
| A10- | KN Pongau | Lammertal Hütttau | 1,98 | 0,1379 | 0,0070 | 1,98 | 0,1379 | 0,0111 | 2,78 | 0,1930 | 0,0162 | 2,79 | 0,1930 | 0,0255 | 4,09 | 0,2206 | 0,0204 | 4,10 | 0,2206 | 0,0321 |
| A10- | Lammertal Hütttau | F. Verbindung GH Eben | 0,51 | 0,0355 | 0,0018 | 0,51 | 0,0355 | 0,0028 | 0,71 | 0,0497 | 0,0042 | 0,72 | 0,0497 | 0,0066 | 1,05 | 0,0568 | 0,0053 | 1,06 | 0,0568 | 0,0083 |
| A10- | F. Verbindung GH Eben | Eben | 0,24 | 0,0164 | 0,0008 | 0,24 | 0,0164 | 0,0013 | 0,33 | 0,0230 | 0,0019 | 0,33 | 0,0230 | 0,0030 | 0,49 | 0,0263 | 0,0024 | 0,49 | 0,0263 | 0,0038 |
| A10- | Eben | Radstadt Altenmarkt Graz | 0,52 | 0,0365 | 0,0019 | 0,53 | 0,0365 | 0,0029 | 0,74 | 0,0511 | 0,0043 | 0,74 | 0,0511 | 0,0067 | 1,08 | 0,0584 | 0,0054 | 1,09 | 0,0584 | 0,0085 |
| A10- | Radstadt Altenmarkt Graz | Flachau | 0,73 | 0,0511 | 0,0026 | 0,73 | 0,0511 | 0,0041 | 1,03 | 0,0715 | 0,0060 | 1,03 | 0,0715 | 0,0094 | 1,52 | 0,0817 | 0,0076 | 1,52 | 0,0817 | 0,0119 |
| A10- | Flachau | Flachauwinkel | 2,86 | 0,0996 | 0,0051 | 2,86 | 0,0996 | 0,0080 | 4,01 | 0,1394 | 0,0117 | 4,01 | 0,1394 | 0,0184 | 5,96 | 0,1594 | 0,0148 | 5,97 | 0,1594 | 0,0232 |
| A10- | Flachauwinkel | Zederhaus | 7,20 | 0,2510 | 0,0128 | 7,21 | 0,2510 | 0,0202 | 10,10 | 0,3514 | 0,0295 | 10,11 | 0,3514 | 0,0464 | 15,01 | 0,4016 | 0,0372 | 15,03 | 0,4016 | 0,0584 |
| A10- | Zederhaus | St. Michael/Lungau | 4,75 | 0,1656 | 0,0085 | 4,76 | 0,1656 | 0,0133 | 6,66 | 0,2318 | 0,0195 | 6,67 | 0,2318 | 0,0306 | 9,91 | 0,2650 | 0,0245 | 9,92 | 0,2650 | 0,0386 |
| A10- | St. Michael/Lungau | Rennweg Katschberg | 3,48 | 0,1214 | 0,0062 | 3,49 | 0,1214 | 0,0097 | 4,88 | 0,1700 | 0,0143 | 4,89 | 0,1700 | 0,0224 | 7,26 | 0,1943 | 0,0180 | 7,27 | 0,1943 | 0,0283 |
| A102 | Seeboden | KN Spittal Millstätter See | 0,38 | 0,0266 | 0,0014 | 0,38 | 0,0266 | 0,0021 | 0,54 | 0,0372 | 0,0031 | 0,54 | 0,0372 | 0,0049 | 0,79 | 0,0425 | 0,0039 | 0,79 | 0,0425 | 0,0062 |
| A102 | KN Spittal Millstätter See | Lendorf | 0,82 | 0,0573 | 0,0029 | 0,82 | 0,0573 | 0,0046 | 1,15 | 0,0803 | 0,0067 | 1,16 | 0,0803 | 0,0106 | 1,70 | 0,0917 | 0,0085 | 1,71 | 0,0917 | 0,0134 |
| A10- | Rennweg Katschberg | Gmünd Maltatal | 3,33 | 0,2320 | 0,0119 | 3,34 | 0,2320 | 0,0186 | 4,67 | 0,3248 | 0,0273 | 4,69 | 0,3248 | 0,0428 | 6,88 | 0,3712 | 0,0344 | 6,90 | 0,3712 | 0,0540 |
| A10- | Gmünd Maltatal | KN Spittal Millstätter See | 1,89 | 0,1320 | 0,0067 | 1,90 | 0,1320 | 0,0106 | 2,66 | 0,1849 | 0,0155 | 2,67 | 0,1849 | 0,0244 | 3,92 | 0,2113 | 0,0196 | 3,93 | 0,2113 | 0,0307 |
| A10- | KN Spittal Millstätter See | Spittal Ost | 1,44 | 0,1000 | 0,0051 | 1,44 | 0,1000 | 0,0080 | 2,01 | 0,1400 | 0,0118 | 2,02 | 0,1400 | 0,0185 | 2,97 | 0,1600 | 0,0148 | 2,98 | 0,1600 | 0,0233 |
| A10- | Spittal Ost | Paternion Feistritz | 2,48 | 0,1727 | 0,0088 | 2,48 | 0,1727 | 0,0139 | 3,48 | 0,2418 | 0,0203 | 3,49 | 0,2418 | 0,0319 | 5,13 | 0,2763 | 0,0256 | 5,14 | 0,2763 | 0,0402 |
| A10- | Paternion Feistritz | Villach West | 2,67 | 0,1862 | 0,0095 | 2,68 | 0,1862 | 0,0149 | 3,75 | 0,2606 | 0,0219 | 3,76 | 0,2606 | 0,0344 | 5,52 | 0,2978 | 0,0276 | 5,54 | 0,2978 | 0,0433 |
| A10- | Villach West | Villach Ossiacher See | 1,15 | 0,0805 | 0,0041 | 1,16 | 0,0805 | 0,0065 | 1,62 | 0,1127 | 0,0095 | 1,63 | 0,1127 | 0,0149 | 2,39 | 0,1288 | 0,0119 | 2,40 | 0,1288 | 0,0187 |
| A10- | Villach Ossiacher See | KN Villach | 0,90 | 0,0629 | 0,0032 | 0,90 | 0,0629 | 0,0050 | 1,27 | 0,0880 | 0,0074 | 1,27 | 0,0880 | 0,0116 | 1,87 | 0,1006 | 0,0093 | 1,87 | 0,1006 | 0,0146 |
| A11- | KN Villach | St. Niklas Faakersee | 0,65 | 0,0450 | 0,0023 | 0,65 | 0,0450 | 0,0036 | 0,91 | 0,0630 | 0,0053 | 0,91 | 0,0630 | 0,0083 | 1,34 | 0,0720 | 0,0067 | 1,34 | 0,0720 | 0,0105 |
| A11- | St. Niklas Faakersee | St. Jakob/Rosental | 1,62 | 0,1130 | 0,0058 | 1,63 | 0,1130 | 0,0091 | 2,28 | 0,1583 | 0,0133 | 2,28 | 0,1583 | 0,0209 | 3,35 | 0,1809 | 0,0167 | 3,36 | 0,1809 | 0,0263 |
| A11- | St. Jakob/Rosental | Staatsgrenze Karawankentunnel | 15,85 | 0,1330 | 0,0068 | 15,85 | 0,1330 | 0,0107 | 22,20 | 0,1862 | 0,0156 | 22,20 | 0,1862 | 0,0246 | 33,22 | 0,2128 | 0,0197 | 33,23 | 0,2128 | 0,0310 |
| A12- | Staatsgrenze Kufstein | Kufstein Nord | 0,36 | 0,0000 | 0,0000 | 0,36 | 0,0000 | 0,0000 | 0,51 | 0,0000 | 0,0000 | 0,51 | 0,0000 | 0,0000 | 0,76 | 0,0000 | 0,0000 | 0,76 | 0,0000 | 0,0000 |
| A12- | Kufstein Nord | Kufstein Süd | 0,93 | 0,0000 | 0,0000 | 0,93 | 0,0000 | 0,0000 | 1,31 | 0,0000 | 0,0000 | 1,31 | 0,0000 | 0,0000 | 1,96 | 0,0000 | 0,0000 | 1,96 | 0,0000 | 0,0000 |
| A12- | Kufstein Süd | Kirchbichl Langkampfen | 1,27 | 0,0000 | 0,0000 | 1,27 | 0,0000 | 0,0000 | 1,78 | 0,0000 | 0,0000 | 1,78 | 0,0000 | 0,0000 | 2,68 | 0,0000 | 0,0000 | 2,68 | 0,0000 | 0,0000 |
| A12- | Kirchbichl Langkampfen | Wörgl Ost St.Johann i. T. Brixental | 1,25 | 0,0000 | 0,0000 | 1,25 | 0,0000 | 0,0000 | 1,75 | 0,0000 | 0,0000 | 1,75 | 0,0000 | 0,0000 | 2,62 | 0,0000 | 0,0000 | 2,62 | 0,0000 | 0,0000 |
| A12- | Wörgl Ost St.Johann i. T. Brixental | Wörgl West | 0,66 | 0,0000 | 0,0000 | 0,66 | 0,0000 | 0,0000 | 0,92 | 0,0000 | 0,0000 | 0,92 | 0,0000 | 0,0000 | 1,38 | 0,0000 | 0,0000 | 1,38 | 0,0000 | 0,0000 |
| A12- | Wörgl West | Kramsach Rattenberg Brixlegg | 2,80 | 0,0000 | 0,0000 | 2,80 | 0,0000 | 0,0000 | 3,92 | 0,0000 | 0,0000 | 3,92 | 0,0000 | 0,0000 | 5,88 | 0,0000 | 0,0000 | 5,88 | 0,0000 | 0,0000 |
| A12- | Kramsach Rattenberg Brixlegg | Wiesing Achensee Zillertal | 1,72 | 0,0000 | 0,0000 | 1,72 | 0,0000 | 0,0000 | 2,40 | 0,0000 | 0,0000 | 2,40 | 0,0000 | 0,0000 | 3,61 | 0,0000 | 0,0000 | 3,61 | 0,0000 | 0,0000 |
| A12- | Wiesing Achensee Zillertal | Jenbach | 0,68 | 0,0000 | 0,0000 | 0,68 | 0,0000 | 0,0000 | 0,95 | 0,0000 | 0,0000 | 0,95 | 0,0000 | 0,0000 | 1,43 | 0,0000 | 0,0000 | 1,43 | 0,0000 | 0,0000 |
| A12- | Jenbach | Schwaz | 1,50 | 0,0000 | 0,0000 | 1,50 | 0,0000 | 0,0000 | 2,10 | 0,0000 | 0,0000 | 2,10 | 0,0000 | 0,0000 | 3,15 | 0,0000 | 0,0000 | 3,15 | 0,0000 | 0,0000 |
| A12- | Schwaz | Vomp | 0,86 | 0,0000 | 0,0000 | 0,86 | 0,0000 | 0,0000 | 1,20 | 0,0000 | 0,0000 | 1,20 | 0,0000 | 0,0000 | 1,80 | 0,0000 | 0,0000 | 1,80 | 0,0000 | 0,0000 |
| A12- | Vomp | Wattens | 1,77 | 0,0000 | 0,0000 | 1,77 | 0,0000 | 0,0000 | 2,47 | 0,0000 | 0,0000 | 2,47 | 0,0000 | 0,0000 | 3,71 | 0,0000 | 0,0000 | 3,71 | 0,0000 | 0,0000 |
| A12- | Wattens | Hall/Tirol Mitte | 1,57 | 0,0000 | 0,0000 | 1,57 | 0,0000 | 0,0000 | 2,19 | 0,0000 | 0,0000 | 2,19 | 0,0000 | 0,0000 | 3,29 | 0,0000 | 0,0000 | 3,29 | 0,0000 | 0,0000 |
| A12- | Hall/Tirol Mitte | Hall/Tirol West | 0,63 | 0,0000 | 0,0000 | 0,63 | 0,0000 | 0,0000 | 0,88 | 0,0000 | 0,0000 | 0,88 | 0,0000 | 0,0000 | 1,32 | 0,0000 | 0,0000 | 1,32 | 0,0000 | 0,0000 |
| A12- | Hall/Tirol West | A12 Innsbruck Ost | 0,70 | 0,0000 | 0,0000 | 0,70 | 0,0000 | 0,0000 | 0,97 | 0,0000 | 0,0000 | 0,97 | 0,0000 | 0,0000 | 1,46 | 0,0000 | 0,0000 | 1,46 | 0,0000 | 0,0000 |
| A12- | A12 Innsbruck Ost | Innsbruck Mitte | 0,46 | 0,0078 | 0,0004 | 0,46 | 0,0078 | 0,0006 | 0,65 | 0,0109 | 0,0009 | 0,65 | 0,0109 | 0,0014 | 0,97 | 0,0124 | 0,0011 | 0,97 | 0,0124 | 0,0018 |
| A12- | Innsbruck Mitte | A12 Innsbruck West | 0,63 | 0,0438 | 0,0022 | 0,63 | 0,0438 | 0,0035 | 0,88 | 0,0614 | 0,0052 | 0,89 | 0,0614 | 0,0081 | 1,30 | 0,0701 | 0,0065 | 1,30 | 0,0701 | 0,0102 |
| A12- | A12 Innsbruck West | Innsbruck Kranebitten | 0,82 | 0,0575 | 0,0029 | 0,83 | 0,0575 | 0,0046 | 1,16 | 0,0804 | 0,0068 | 1,16 | 0,0804 | 0,0106 | 1,71 | 0,0919 | 0,0085 | 1,71 | 0,0919 | 0,0134 |
| A12- | Innsbruck Kranebitten | Zirl Ost Garmisch Seefeld | 0,96 | 0,0667 | 0,0034 | 0,96 | 0,0667 | 0,0054 | 1,34 | 0,0933 | 0,0078 | 1,35 | 0,0933 | 0,0123 | 1,98 | 0,1067 | 0,0099 | 1,98 | 0,1067 | 0,0155 |
| A12- | Zirl Ost Garmisch Seefeld | Zirl West | 0,60 | 0,0417 | 0,0021 | 0,60 | 0,0417 | 0,0033 | 0,84 | 0,0584 | 0,0049 | 0,84 | 0,0584 | 0,0077 | 1,24 | 0,0667 | 0,0062 | 1,24 | 0,0667 | 0,0097 |
| A12- | Zirl West | Petttau | 1,07 | 0,0747 | 0,0038 | 1,07 | 0,0747 | 0,0060 | 1,50 | 0,1046 | 0,0088 | 1,51 | 0,1046 | 0,0138 | 2,22 | 0,1195 | 0,0111 | 2,22 | 0,1195 | 0,0174 |
| A12- | Petttau | Telfs Ost | 1,08 | 0,0755 | 0,0039 | 1,09 | 0,0755 | 0,0061 | 1,52 | 0,1057 | 0,0089 | 1,53 | 0,1057 | 0,0139 | 2,24 | 0,1208 | 0,0112 | 2,25 | 0,1208 | 0,0176 |
| A12- | Telfs Ost | Telfs West | 0,53 | 0,0369 | 0,0019 | 0,53 | 0,0369 | 0,0030 | 0,74 | 0,0516 | 0,0043 | 0,75 | 0,0516 | 0,0068 | 1,09 | 0,0590 | 0,0055 | 1,10 | 0,0590 | 0,0086 |
| A12- | Telfs West | Mötz Reutte | 1,71 | 0,1192 | 0,0061 | 1,71 | 0,1192 | 0,0096 | 2,40 | 0,1669 | 0,0140 | 2,41 | 0,1669 | 0,0220 | 3,54 | 0,1907 | 0,0177 | 3,55 | 0,1907 | 0,0278 |
| A12- | Mötz Reutte | Haiming Ötztal | 1,99 | 0,1386 | 0,0071 | 1,99 | 0,1386 | 0,0111 | 2,79 | 0,1941 | 0,0163 | 2,80 | 0,1941 | 0,0256 | 4,11 | 0,2218 | 0,0205 | 4,13 | 0,2218 | 0,0323 |
| A12- | Haiming Ötztal | Imst | 1,58 | 0,1104 | 0,0056 | 1,59 | 0,1104 | 0,0089 | 2,22 | 0,1545 | 0,0130 | 2,23 | 0,1545 | 0,0204 | 3,28 | 0,1766 | 0,0164 | 3,28 | 0,1766 | 0,0257 |
| A12- | Imst | Imst Au | 0,27 | 0,0187 | 0,0010 | 0,27 | 0,0187 | 0,0015 | 0,38 | 0,0262 | 0,0022 | 0,38 | 0,0262 | 0,0035 | 0,55 | 0,0299 | 0,0028 | 0,56 | 0,0299 | 0,0044 |
| A12- | Imst Au | Mils | 0,58 | 0,0401 | 0,0021 | 0,58 | 0,0401 | 0,0032 | 0,81 | 0,0562 | 0,0047 | 0,81 | 0,0562 | 0,0074 | 1,19 | 0,0642 | 0,0059 | 1,19 | 0,0642 | 0,0093 |
| A12- | Mils | Mils Schönwies | 0,93 | 0,0647 | 0,0033 | 0,93 | 0,0647 | 0,0052 | 1,30 | 0,0905 | 0,0076 | 1,31 | 0,0905 | 0,0119 | 1,92 | 0,1035 | 0,0096 | 1,92 | 0 | |

| | | | | | | | | | | | | | | | | | | | | |
|------|------------------------------------|------------------------------------|------|--------|--------|------|--------|--------|------|--------|--------|------|--------|--------|------|--------|--------|------|--------|--------|
| A14- | Staatsgrenze Hörbranz | Hörbranz Lochau | 0,25 | 0,0173 | 0,0009 | 0,25 | 0,0173 | 0,0014 | 0,35 | 0,0242 | 0,0020 | 0,35 | 0,0242 | 0,0032 | 0,51 | 0,0276 | 0,0026 | 0,51 | 0,0276 | 0,0040 |
| A14- | Hörbranz Lochau | KN Bregenz | 1,52 | 0,1062 | 0,0054 | 1,53 | 0,1062 | 0,0085 | 2,14 | 0,1486 | 0,0125 | 2,14 | 0,1486 | 0,0196 | 3,15 | 0,1699 | 0,0157 | 3,16 | 0,1699 | 0,0247 |
| A14- | KN Bregenz | Lauterach Wolfurt | 0,08 | 0,0053 | 0,0003 | 0,08 | 0,0053 | 0,0004 | 0,11 | 0,0075 | 0,0006 | 0,11 | 0,0075 | 0,0010 | 0,16 | 0,0085 | 0,0008 | 0,16 | 0,0085 | 0,0012 |
| A14- | Lauterach Wolfurt | Wolfurt Lauterach | 0,68 | 0,0472 | 0,0024 | 0,68 | 0,0472 | 0,0038 | 0,95 | 0,0661 | 0,0056 | 0,95 | 0,0661 | 0,0087 | 1,40 | 0,0756 | 0,0070 | 1,41 | 0,0756 | 0,0110 |
| A14- | Wolfurt Lauterach | Dornbirn Nord Bregenzerwald | 0,26 | 0,0183 | 0,0009 | 0,26 | 0,0183 | 0,0015 | 0,37 | 0,0256 | 0,0021 | 0,37 | 0,0256 | 0,0034 | 0,54 | 0,0292 | 0,0027 | 0,54 | 0,0292 | 0,0043 |
| A14- | Dornbirn Nord Bregenzerwald | Dornbirn Süd Lustenau | 0,73 | 0,0511 | 0,0026 | 0,73 | 0,0511 | 0,0041 | 1,03 | 0,0715 | 0,0060 | 1,03 | 0,0715 | 0,0094 | 1,52 | 0,0817 | 0,0076 | 1,52 | 0,0817 | 0,0119 |
| A14- | Dornbirn Süd Lustenau | Hohenems | 1,03 | 0,0718 | 0,0037 | 1,03 | 0,0718 | 0,0058 | 1,45 | 0,1006 | 0,0084 | 1,45 | 0,1006 | 0,0133 | 2,13 | 0,1149 | 0,0106 | 2,14 | 0,1149 | 0,0167 |
| A14- | Hohenems | Altach Götzis | 0,67 | 0,0468 | 0,0024 | 0,67 | 0,0468 | 0,0038 | 0,94 | 0,0656 | 0,0055 | 0,95 | 0,0656 | 0,0087 | 1,39 | 0,0749 | 0,0069 | 1,39 | 0,0749 | 0,0109 |
| A14- | Altach Götzis | Götzis | 0,51 | 0,0357 | 0,0018 | 0,51 | 0,0357 | 0,0029 | 0,72 | 0,0500 | 0,0042 | 0,72 | 0,0500 | 0,0066 | 1,06 | 0,0571 | 0,0053 | 1,06 | 0,0571 | 0,0083 |
| A14- | Götzis | Klaus Koblach | 0,45 | 0,0310 | 0,0016 | 0,45 | 0,0310 | 0,0025 | 0,62 | 0,0434 | 0,0036 | 0,63 | 0,0434 | 0,0057 | 0,92 | 0,0496 | 0,0046 | 0,92 | 0,0496 | 0,0072 |
| A14- | Klaus Koblach | Rankweil | 0,78 | 0,0545 | 0,0028 | 0,78 | 0,0545 | 0,0044 | 1,10 | 0,0763 | 0,0064 | 1,10 | 0,0763 | 0,0101 | 1,62 | 0,0872 | 0,0081 | 1,62 | 0,0872 | 0,0127 |
| A14- | Rankweil | Feldkirch Frastanz | 1,11 | 0,0777 | 0,0040 | 1,12 | 0,0777 | 0,0062 | 1,56 | 0,1087 | 0,0091 | 1,57 | 0,1087 | 0,0143 | 2,30 | 0,1242 | 0,0115 | 2,31 | 0,1242 | 0,0181 |
| A14- | Feldkirch Frastanz | Nenzing Bludesch | 1,76 | 0,1228 | 0,0063 | 1,77 | 0,1228 | 0,0099 | 2,47 | 0,1719 | 0,0144 | 2,48 | 0,1719 | 0,0227 | 3,64 | 0,1965 | 0,0182 | 3,65 | 0,1965 | 0,0286 |
| A14- | Nenzing Bludesch | Bludenz Nüziders | 1,31 | 0,0912 | 0,0047 | 1,31 | 0,0912 | 0,0073 | 1,84 | 0,1276 | 0,0107 | 1,84 | 0,1276 | 0,0168 | 2,71 | 0,1459 | 0,0135 | 2,71 | 0,1459 | 0,0212 |
| A14- | Bludenz Nüziders | Brandnertal | 0,18 | 0,0127 | 0,0006 | 0,18 | 0,0127 | 0,0010 | 0,26 | 0,0178 | 0,0015 | 0,26 | 0,0178 | 0,0023 | 0,38 | 0,0203 | 0,0019 | 0,38 | 0,0203 | 0,0030 |
| A14- | Brandnertal | Bludenz Bürs | 0,30 | 0,0212 | 0,0011 | 0,30 | 0,0212 | 0,0017 | 0,43 | 0,0296 | 0,0025 | 0,43 | 0,0296 | 0,0039 | 0,63 | 0,0339 | 0,0031 | 0,63 | 0,0339 | 0,0049 |
| A14- | Bludenz Bürs | Bludenz Montafon | 0,43 | 0,0300 | 0,0015 | 0,43 | 0,0300 | 0,0024 | 0,60 | 0,0420 | 0,0035 | 0,61 | 0,0420 | 0,0055 | 0,89 | 0,0480 | 0,0044 | 0,89 | 0,0480 | 0,0070 |
| A141 | KN Bregenz | Bregenz Citytunnel | 0,39 | 0,0275 | 0,0014 | 0,40 | 0,0275 | 0,0022 | 0,55 | 0,0385 | 0,0032 | 0,56 | 0,0385 | 0,0051 | 0,82 | 0,0440 | 0,0041 | 0,82 | 0,0440 | 0,0064 |
| A21- | KN Steinhäusl | Hochstraß | 0,65 | 0,0453 | 0,0023 | 0,65 | 0,0453 | 0,0036 | 0,91 | 0,0635 | 0,0053 | 0,92 | 0,0635 | 0,0084 | 1,35 | 0,0725 | 0,0067 | 1,35 | 0,0725 | 0,0106 |
| A21- | Hochstraß | Alland | 2,27 | 0,1584 | 0,0081 | 2,28 | 0,1584 | 0,0127 | 3,19 | 0,2217 | 0,0186 | 3,20 | 0,2217 | 0,0292 | 4,70 | 0,2534 | 0,0235 | 4,71 | 0,2534 | 0,0369 |
| A21- | Alland | Mayerling | 0,46 | 0,0322 | 0,0016 | 0,46 | 0,0322 | 0,0026 | 0,65 | 0,0450 | 0,0038 | 0,65 | 0,0450 | 0,0059 | 0,95 | 0,0514 | 0,0048 | 0,96 | 0,0514 | 0,0075 |
| A21- | Mayerling | Heiligenkreuz | 1,07 | 0,0745 | 0,0038 | 1,07 | 0,0745 | 0,0060 | 1,50 | 0,1043 | 0,0088 | 1,51 | 0,1043 | 0,0138 | 2,21 | 0,1192 | 0,0110 | 2,22 | 0,1192 | 0,0173 |
| A21- | Heiligenkreuz | Heiligenbrühl | 0,60 | 0,0415 | 0,0021 | 0,60 | 0,0415 | 0,0033 | 0,84 | 0,0581 | 0,0049 | 0,84 | 0,0581 | 0,0077 | 1,23 | 0,0664 | 0,0062 | 1,24 | 0,0664 | 0,0097 |
| A21- | Hinterbrühl | Gießhübl | 1,12 | 0,0779 | 0,0040 | 1,12 | 0,0779 | 0,0063 | 1,57 | 0,1090 | 0,0092 | 1,57 | 0,1090 | 0,0144 | 2,31 | 0,1246 | 0,0115 | 2,32 | 0,1246 | 0,0181 |
| A21- | Gießhübl | Brunn/Gebirge | 0,94 | 0,0652 | 0,0033 | 0,94 | 0,0652 | 0,0052 | 1,31 | 0,0912 | 0,0077 | 1,32 | 0,0912 | 0,0120 | 1,93 | 0,1043 | 0,0097 | 1,94 | 0,1043 | 0,0152 |
| A21- | Brunn/Gebirge | KN Vösendorf | 0,42 | 0,0290 | 0,0015 | 0,42 | 0,0290 | 0,0023 | 0,58 | 0,0406 | 0,0034 | 0,59 | 0,0406 | 0,0054 | 0,86 | 0,0464 | 0,0043 | 0,86 | 0,0464 | 0,0068 |
| A22- | KN Wien Kaisermühlen | Kaisermühlen | 0,33 | 0,0229 | 0,0012 | 0,33 | 0,0229 | 0,0018 | 0,46 | 0,0321 | 0,0027 | 0,46 | 0,0321 | 0,0042 | 0,68 | 0,0367 | 0,0034 | 0,68 | 0,0367 | 0,0053 |
| A22- | Kaisermühlen | Reichsbrücke | 0,27 | 0,0190 | 0,0010 | 0,27 | 0,0190 | 0,0015 | 0,38 | 0,0266 | 0,0022 | 0,38 | 0,0266 | 0,0035 | 0,56 | 0,0304 | 0,0028 | 0,57 | 0,0304 | 0,0044 |
| A22- | Reichsbrücke | Kagran Vienna International Center | 0,11 | 0,0073 | 0,0004 | 0,11 | 0,0073 | 0,0006 | 0,15 | 0,0102 | 0,0009 | 0,15 | 0,0102 | 0,0014 | 0,22 | 0,0117 | 0,0011 | 0,22 | 0,0117 | 0,0017 |
| A22- | Kagran Vienna International Center | Brigittenerbrücke | 0,17 | 0,0117 | 0,0006 | 0,17 | 0,0117 | 0,0009 | 0,24 | 0,0164 | 0,0014 | 0,24 | 0,0164 | 0,0022 | 0,35 | 0,0187 | 0,0017 | 0,35 | 0,0187 | 0,0027 |
| A22- | Brigittenerbrücke | Floridsdorferbrücke | 0,27 | 0,0189 | 0,0010 | 0,27 | 0,0189 | 0,0015 | 0,38 | 0,0265 | 0,0022 | 0,38 | 0,0265 | 0,0035 | 0,56 | 0,0302 | 0,0028 | 0,56 | 0,0302 | 0,0044 |
| A22- | Floridsdorferbrücke | KN Gürtel Nordbrücke | 0,17 | 0,0121 | 0,0006 | 0,17 | 0,0121 | 0,0010 | 0,24 | 0,0169 | 0,0014 | 0,24 | 0,0169 | 0,0022 | 0,36 | 0,0193 | 0,0018 | 0,36 | 0,0193 | 0,0028 |
| A22- | KN Gürtel Nordbrücke | Strebersdorf | 0,59 | 0,0412 | 0,0021 | 0,59 | 0,0412 | 0,0033 | 0,83 | 0,0577 | 0,0048 | 0,83 | 0,0577 | 0,0076 | 1,22 | 0,0659 | 0,0061 | 1,23 | 0,0659 | 0,0096 |
| A221 | Wien Nordbrücke | KN Gürtel Nordbrücke | 0,17 | 0,0122 | 0,0006 | 0,17 | 0,0122 | 0,0010 | 0,24 | 0,0170 | 0,0014 | 0,25 | 0,0170 | 0,0022 | 0,36 | 0,0194 | 0,0018 | 0,36 | 0,0194 | 0,0028 |
| A221 | KN Gürtel Nordbrücke | Wien Pragerstraße | 0,19 | 0,0131 | 0,0007 | 0,19 | 0,0131 | 0,0011 | 0,26 | 0,0183 | 0,0015 | 0,26 | 0,0183 | 0,0024 | 0,39 | 0,0209 | 0,0019 | 0,39 | 0,0209 | 0,0030 |
| A221 | Wien Pragerstraße | Wien Neujedlersdorf | 0,08 | 0,0057 | 0,0003 | 0,08 | 0,0057 | 0,0005 | 0,12 | 0,0080 | 0,0007 | 0,12 | 0,0080 | 0,0011 | 0,17 | 0,0092 | 0,0008 | 0,17 | 0,0092 | 0,0013 |
| A221 | Wien Neujedlersdorf | Brünnerstr/Shuttlewortstraße | 0,21 | 0,0145 | 0,0007 | 0,21 | 0,0145 | 0,0012 | 0,29 | 0,0203 | 0,0017 | 0,29 | 0,0203 | 0,0027 | 0,43 | 0,0232 | 0,0022 | 0,43 | 0,0232 | 0,0034 |
| A22- | Strebersdorf | Korneuburg Ost | 1,19 | 0,0830 | 0,0042 | 1,19 | 0,0830 | 0,0067 | 1,67 | 0,1162 | 0,0098 | 1,68 | 0,1162 | 0,0153 | 2,46 | 0,1328 | 0,0123 | 2,47 | 0,1328 | 0,0193 |
| A222 | Strebersdorf | Wien Vohburggasse | 0,15 | 0,0103 | 0,0005 | 0,15 | 0,0103 | 0,0008 | 0,21 | 0,0144 | 0,0012 | 0,21 | 0,0144 | 0,0019 | 0,31 | 0,0165 | 0,0015 | 0,31 | 0,0165 | 0,0024 |
| A22- | Korneuburg Ost | KN Korneuburg | 0,77 | 0,0536 | 0,0027 | 0,77 | 0,0536 | 0,0043 | 1,08 | 0,0750 | 0,0063 | 1,08 | 0,0750 | 0,0099 | 1,59 | 0,0857 | 0,0079 | 1,59 | 0,0857 | 0,0125 |
| A22- | KN Korneuburg | Stockerau Ost | 1,12 | 0,0780 | 0,0040 | 1,12 | 0,0780 | 0,0063 | 1,57 | 0,1091 | 0,0092 | 1,57 | 0,1091 | 0,0144 | 2,31 | 0,1247 | 0,0116 | 2,32 | 0,1247 | 0,0182 |
| A22- | Stockerau Ost | Stockerau Mitte | 0,45 | 0,0311 | 0,0016 | 0,45 | 0,0311 | 0,0025 | 0,63 | 0,0435 | 0,0037 | 0,63 | 0,0435 | 0,0057 | 0,92 | 0,0497 | 0,0046 | 0,93 | 0,0497 | 0,0072 |
| A22- | Stockerau Mitte | KN Stockerau/West | 0,38 | 0,0264 | 0,0013 | 0,38 | 0,0264 | 0,0021 | 0,53 | 0,0370 | 0,0031 | 0,53 | 0,0370 | 0,0049 | 0,78 | 0,0422 | 0,0039 | 0,79 | 0,0422 | 0,0061 |
| A23- | Altmannsdorferstraße | KN Wien Inzersdorf | 0,33 | 0,0231 | 0,0012 | 0,33 | 0,0231 | 0,0019 | 0,47 | 0,0323 | 0,0027 | 0,47 | 0,0323 | 0,0043 | 0,69 | 0,0370 | 0,0034 | 0,69 | 0,0370 | 0,0054 |
| A23- | KN Wien Inzersdorf | Favoriten | 0,84 | 0,0583 | 0,0030 | 0,84 | 0,0583 | 0,0047 | 1,17 | 0,0816 | 0,0068 | 1,18 | 0,0816 | 0,0108 | 1,73 | 0,0932 | 0,0086 | 1,73 | 0,0932 | 0,0136 |
| A23- | Favoriten | KN Gürtel Landstraßer Hauptstraße | 0,52 | 0,0365 | 0,0019 | 0,52 | 0,0365 | 0,0029 | 0,73 | 0,0511 | 0,0043 | 0,74 | 0,0511 | 0,0067 | 1,08 | 0,0584 | 0,0054 | 1,09 | 0,0584 | 0,0085 |
| A23- | KN Gürtel Landstraßer Hauptstraße | St. Marx | 0,20 | 0,0139 | 0,0007 | 0,20 | 0,0139 | 0,0011 | 0,28 | 0,0194 | 0,0016 | 0,28 | 0,0194 | 0,0026 | 0,41 | 0,0222 | 0,0021 | 0,41 | 0,0222 | 0,0032 |
| A23- | St. Marx | KN Wien Prater | 0,17 | 0,0118 | 0,0006 | 0,17 | 0,0118 | 0,0009 | 0,24 | 0,0165 | 0,0014 | 0,24 | 0,0165 | 0,0022 | 0,35 | 0,0188 | 0,0017 | 0,35 | 0,0188 | 0,0027 |
| A23- | KN Wien Prater | Handelskai | 0,37 | 0,0261 | 0,0013 | 0,38 | 0,0261 | 0,0021 | 0,53 | 0,0365 | 0,0031 | 0,53 | 0,0365 | 0,0048 | 0,77 | 0,0418 | 0,0039 | 0,78 | 0,0418 | 0,0061 |
| A23- | Handelskai | KN Wien Kaisermühlen | 0,17 | 0,0119 | 0,0006 | 0,17 | 0,0119 | 0,0010 | 0,24 | 0,0167 | 0,0014 | 0,24 | 0,0167 | 0,0022 | 0,35 | 0,0191 | 0,0018 | 0,36 | 0,0191 | 0,0028 |
| A23- | KN Wien Kaisermühlen | Groß Enzersdorf Stadlau | 0,47 | 0,0327 | 0,0017 | 0,47 | 0,0327 | 0,0026 | 0,66 | 0,0458 | 0,0038 | 0,66 | 0,0458 | 0,0060 | 0,97 | 0,0524 | 0,0049 | 0,97 | 0,0524 | 0,0076 |
| A23- | Groß Enzersdorf Stadlau | Hirschstetten | 0,26 | 0,0184 | 0,0009 | 0,26 | 0,0184 | 0,0015 | 0,37 | 0,0257 | 0,0022 | 0,37 | 0,0257 | 0,0034 | 0,54 | 0,0294 | 0,0027 | 0,55 | 0,0294 | 0,0043 |
| A233 | KN Gürtel Landstraßer Hauptstraße | Wien Gürtel | 0,15 | 0,0107 | 0,0005 | 0,15 | 0,0107 | 0,0009 | 0,22 | 0,0150 | 0,0013 | 0,22 | 0,0150 | 0,0020 | 0,32 | 0,0171 | 0,0016 | 0,32 | 0,0171 | 0,0025 |
| A25- | KN A1/A25 Passau Wels | Weißkirchen | 1,73 | 0,1208 | 0,0062 | 1,74 | 0,1208 | 0,0097 | 2,43 | 0,1691 | 0,0142 | 2,44 | 0,1691 | 0,0223 | 3,58 | 0,1932 | 0,0179 | 3,59 | 0,1932 | 0,0281 |
| A25- | Weißkirchen | Marchtrenk Wels Ost | 0,62 | 0,0430 | 0,0022 | 0,62 | 0,0430 | 0,0035 | 0,87 | 0,0602 | 0,0051 | 0,87 | 0,0602 | 0,0079 | 1,28 | 0,0689 | 0,0064 | 1,28 | 0,0689 | 0,0100 |
| A25- | Marchtrenk Wels Ost | ÖBB Terminal Wels | 0,17 | 0,0116 | 0,0006 | 0,17 | 0,0116 | 0,0009 | 0,23 | 0,0162 | 0,0014 | 0,23 | 0,0162 | 0,0021 | 0,34 | 0,0185 | 0,0017 | 0,34 | 0,0185 | 0,0027 |
| A | | | | | | | | | | | | | | | | | | | | |

| | | | | | | | | | | | | | | | | | | | | |
|------|-----------------------------------|-----------------------------------|------|--------|--------|------|--------|--------|------|--------|--------|------|--------|--------|------|--------|--------|------|--------|--------|
| S01- | Seyring | KN Eibesbrunn | 0,81 | 0,0565 | 0,0029 | 0,81 | 0,0565 | 0,0045 | 1,14 | 0,0791 | 0,0066 | 1,14 | 0,0791 | 0,0104 | 1,68 | 0,0904 | 0,0084 | 1,68 | 0,0904 | 0,0131 |
| S01- | KN Eibesbrunn | Hagenbrunn | 0,64 | 0,0445 | 0,0023 | 0,64 | 0,0445 | 0,0036 | 0,90 | 0,0622 | 0,0052 | 0,90 | 0,0622 | 0,0082 | 1,32 | 0,0711 | 0,0066 | 1,32 | 0,0711 | 0,0104 |
| S01- | Hagenbrunn | Korneuburg Nord | 1,36 | 0,0951 | 0,0049 | 1,37 | 0,0951 | 0,0076 | 1,92 | 0,1331 | 0,0112 | 1,92 | 0,1331 | 0,0176 | 2,82 | 0,1522 | 0,0141 | 2,83 | 0,1522 | 0,0221 |
| S01- | Korneuburg Nord | Korneuburg West | 0,55 | 0,0386 | 0,0020 | 0,55 | 0,0386 | 0,0031 | 0,78 | 0,0540 | 0,0045 | 0,78 | 0,0540 | 0,0071 | 1,14 | 0,0617 | 0,0057 | 1,15 | 0,0617 | 0,0090 |
| S01- | Korneuburg West | KN Korneuburg | 0,18 | 0,0123 | 0,0006 | 0,18 | 0,0123 | 0,0010 | 0,25 | 0,0172 | 0,0014 | 0,25 | 0,0172 | 0,0023 | 0,37 | 0,0197 | 0,0018 | 0,37 | 0,0197 | 0,0029 |
| S02- | Hirschstetten | Gewerbepark Stadlau | 0,19 | 0,0132 | 0,0007 | 0,19 | 0,0132 | 0,0011 | 0,27 | 0,0185 | 0,0016 | 0,27 | 0,0185 | 0,0024 | 0,39 | 0,0212 | 0,0020 | 0,39 | 0,0212 | 0,0031 |
| S02- | Gewerbepark Stadlau | Breitenleer Straße | 0,11 | 0,0073 | 0,0004 | 0,11 | 0,0073 | 0,0006 | 0,15 | 0,0103 | 0,0009 | 0,15 | 0,0103 | 0,0014 | 0,22 | 0,0117 | 0,0011 | 0,22 | 0,0117 | 0,0017 |
| S02- | Breitenleer Straße | Rautenweg | 0,17 | 0,0122 | 0,0006 | 0,18 | 0,0122 | 0,0010 | 0,24 | 0,0170 | 0,0014 | 0,25 | 0,0170 | 0,0022 | 0,36 | 0,0195 | 0,0018 | 0,36 | 0,0195 | 0,0028 |
| S02- | Rautenweg | Hermann Gebauer Straße | 0,19 | 0,0134 | 0,0007 | 0,19 | 0,0134 | 0,0011 | 0,27 | 0,0187 | 0,0016 | 0,27 | 0,0187 | 0,0025 | 0,40 | 0,0214 | 0,0020 | 0,40 | 0,0214 | 0,0031 |
| S02- | Hermann Gebauer Straße | Angerner Straße | 0,69 | 0,0484 | 0,0025 | 0,70 | 0,0484 | 0,0039 | 0,97 | 0,0677 | 0,0057 | 0,98 | 0,0677 | 0,0089 | 1,44 | 0,0774 | 0,0072 | 1,44 | 0,0774 | 0,0113 |
| S03- | KN Stockerau/West | Stockerau Nord | 0,20 | 0,0137 | 0,0007 | 0,20 | 0,0137 | 0,0011 | 0,28 | 0,0191 | 0,0016 | 0,28 | 0,0191 | 0,0025 | 0,41 | 0,0219 | 0,0020 | 0,41 | 0,0219 | 0,0032 |
| S03- | Stockerau Nord | Sierndorf | 1,05 | 0,0735 | 0,0038 | 1,06 | 0,0735 | 0,0059 | 1,48 | 0,1029 | 0,0086 | 1,48 | 0,1029 | 0,0136 | 2,18 | 0,1176 | 0,0109 | 2,19 | 0,1176 | 0,0171 |
| S03- | Sierndorf | Obermallebarn | 0,71 | 0,0493 | 0,0025 | 0,71 | 0,0493 | 0,0040 | 0,99 | 0,0691 | 0,0058 | 1,00 | 0,0691 | 0,0091 | 1,46 | 0,0790 | 0,0073 | 1,47 | 0,0790 | 0,0115 |
| S03- | Obermallebarn | Göllersdorf | 0,94 | 0,0652 | 0,0033 | 0,94 | 0,0652 | 0,0052 | 1,31 | 0,0912 | 0,0077 | 1,32 | 0,0912 | 0,0120 | 1,93 | 0,1043 | 0,0097 | 1,94 | 0,1043 | 0,0152 |
| S03- | Göllersdorf | Großstelzendorf | 0,37 | 0,0261 | 0,0013 | 0,38 | 0,0261 | 0,0021 | 0,53 | 0,0365 | 0,0031 | 0,53 | 0,0365 | 0,0048 | 0,77 | 0,0418 | 0,0039 | 0,78 | 0,0418 | 0,0061 |
| S03- | Großstelzendorf | Hollabrunn Süd | 0,90 | 0,0628 | 0,0032 | 0,90 | 0,0628 | 0,0050 | 1,26 | 0,0879 | 0,0074 | 1,27 | 0,0879 | 0,0116 | 1,86 | 0,1004 | 0,0093 | 1,87 | 0,1004 | 0,0146 |
| S04- | KN Mattersburg | Sigleß | 0,47 | 0,0324 | 0,0017 | 0,47 | 0,0324 | 0,0026 | 0,65 | 0,0454 | 0,0038 | 0,66 | 0,0454 | 0,0060 | 0,96 | 0,0519 | 0,0048 | 0,97 | 0,0519 | 0,0076 |
| S04- | Sigleß | Bad Sauerbrunn | 1,09 | 0,0758 | 0,0039 | 1,09 | 0,0758 | 0,0061 | 1,53 | 0,1061 | 0,0089 | 1,53 | 0,1061 | 0,0140 | 2,25 | 0,1213 | 0,0112 | 2,26 | 0,1213 | 0,0177 |
| S04- | Bad Sauerbrunn | Neudörfel | 0,46 | 0,0319 | 0,0016 | 0,46 | 0,0319 | 0,0026 | 0,64 | 0,0446 | 0,0037 | 0,64 | 0,0446 | 0,0059 | 0,95 | 0,0510 | 0,0047 | 0,95 | 0,0510 | 0,0074 |
| S04- | Neudörfel | Wr. Neustadt Ost | 0,48 | 0,0333 | 0,0017 | 0,48 | 0,0333 | 0,0027 | 0,67 | 0,0467 | 0,0039 | 0,67 | 0,0467 | 0,0062 | 0,99 | 0,0534 | 0,0049 | 0,99 | 0,0534 | 0,0078 |
| S04- | Wr. Neustadt Ost | Katzelsdorf | 0,22 | 0,0156 | 0,0008 | 0,22 | 0,0156 | 0,0013 | 0,31 | 0,0219 | 0,0018 | 0,32 | 0,0219 | 0,0029 | 0,46 | 0,0250 | 0,0023 | 0,46 | 0,0250 | 0,0036 |
| S04- | Katzelsdorf | Lanzenkirchen | 0,19 | 0,0131 | 0,0007 | 0,19 | 0,0131 | 0,0010 | 0,26 | 0,0183 | 0,0015 | 0,26 | 0,0183 | 0,0024 | 0,39 | 0,0209 | 0,0019 | 0,39 | 0,0209 | 0,0030 |
| S04- | Lanzenkirchen | Wr. Neustadt Süd | 0,17 | 0,0116 | 0,0006 | 0,17 | 0,0116 | 0,0009 | 0,23 | 0,0162 | 0,0014 | 0,23 | 0,0162 | 0,0021 | 0,34 | 0,0185 | 0,0017 | 0,34 | 0,0185 | 0,0027 |
| S04- | Wr. Neustadt Süd | KN Wr. Neustadt | 0,28 | 0,0192 | 0,0010 | 0,28 | 0,0192 | 0,0015 | 0,39 | 0,0269 | 0,0023 | 0,39 | 0,0269 | 0,0035 | 0,57 | 0,0307 | 0,0028 | 0,57 | 0,0307 | 0,0045 |
| S05- | KN Stockerau/West | Tulln | 1,90 | 0,1323 | 0,0068 | 1,90 | 0,1323 | 0,0106 | 2,67 | 0,1853 | 0,0156 | 2,67 | 0,1853 | 0,0244 | 3,93 | 0,2117 | 0,0196 | 3,94 | 0,2117 | 0,0308 |
| S05- | Tulln | Königsbrunn / Wagram | 2,38 | 0,1658 | 0,0085 | 2,38 | 0,1658 | 0,0133 | 3,34 | 0,2321 | 0,0195 | 3,35 | 0,2321 | 0,0306 | 4,92 | 0,2652 | 0,0246 | 4,93 | 0,2652 | 0,0386 |
| S05- | Königsbrunn / Wagram | Kirchberg/Wagram | 0,63 | 0,0442 | 0,0023 | 0,64 | 0,0442 | 0,0035 | 0,89 | 0,0619 | 0,0052 | 0,89 | 0,0619 | 0,0082 | 1,31 | 0,0707 | 0,0065 | 1,31 | 0,0707 | 0,0103 |
| S05- | Kirchberg/Wagram | Fels / Wagram | 0,48 | 0,0331 | 0,0017 | 0,48 | 0,0331 | 0,0027 | 0,67 | 0,0463 | 0,0039 | 0,67 | 0,0463 | 0,0061 | 0,98 | 0,0530 | 0,0049 | 0,99 | 0,0530 | 0,0077 |
| S05- | Fels / Wagram | Grafenwörth | 1,09 | 0,0762 | 0,0039 | 1,10 | 0,0762 | 0,0061 | 1,53 | 0,1067 | 0,0090 | 1,54 | 0,1067 | 0,0141 | 2,26 | 0,1219 | 0,0113 | 2,27 | 0,1219 | 0,0177 |
| S05- | Grafenwörth | Jettsdorf | 0,49 | 0,0341 | 0,0017 | 0,49 | 0,0341 | 0,0027 | 0,69 | 0,0477 | 0,0040 | 0,69 | 0,0477 | 0,0063 | 1,01 | 0,0545 | 0,0050 | 1,01 | 0,0545 | 0,0079 |
| S06- | KN Seebenstein | Neunkirchen | 0,75 | 0,0520 | 0,0027 | 0,75 | 0,0520 | 0,0042 | 1,05 | 0,0728 | 0,0061 | 1,05 | 0,0728 | 0,0096 | 1,54 | 0,0832 | 0,0077 | 1,55 | 0,0832 | 0,0121 |
| S06- | Neunkirchen | Gloggnitz | 2,39 | 0,1667 | 0,0085 | 2,40 | 0,1667 | 0,0134 | 3,36 | 0,2334 | 0,0196 | 3,37 | 0,2334 | 0,0308 | 4,95 | 0,2668 | 0,0247 | 4,96 | 0,2668 | 0,0388 |
| S06- | Gloggnitz | Maria Schutz | 1,53 | 0,1063 | 0,0054 | 1,53 | 0,1063 | 0,0085 | 2,14 | 0,1488 | 0,0125 | 2,15 | 0,1488 | 0,0196 | 3,15 | 0,1700 | 0,0157 | 3,16 | 0,1700 | 0,0247 |
| S06- | Maria Schutz | Spital / Semmering | 1,29 | 0,0902 | 0,0046 | 1,30 | 0,0902 | 0,0072 | 1,82 | 0,1263 | 0,0106 | 1,82 | 0,1263 | 0,0167 | 2,68 | 0,1443 | 0,0134 | 2,68 | 0,1443 | 0,0210 |
| S06- | Spital / Semmering | Mürzzuschlag Ost | 1,08 | 0,0754 | 0,0039 | 1,08 | 0,0754 | 0,0061 | 1,52 | 0,1055 | 0,0089 | 1,52 | 0,1055 | 0,0139 | 2,24 | 0,1206 | 0,0112 | 2,24 | 0,1206 | 0,0175 |
| S06- | Mürzzuschlag Ost | Mariazell, Mürzsteg, Mürzzuschlag | 0,96 | 0,0668 | 0,0034 | 0,96 | 0,0668 | 0,0054 | 1,35 | 0,0935 | 0,0079 | 1,35 | 0,0935 | 0,0123 | 1,98 | 0,1069 | 0,0099 | 1,99 | 0,1069 | 0,0156 |
| S06- | Mariazell, Mürzsteg, Mürzzuschlag | Hönigsberg | 0,68 | 0,0476 | 0,0024 | 0,68 | 0,0476 | 0,0038 | 0,96 | 0,0667 | 0,0056 | 0,96 | 0,0667 | 0,0088 | 1,41 | 0,0762 | 0,0071 | 1,42 | 0,0762 | 0,0111 |
| S06- | Hönigsberg | Langenwang | 0,38 | 0,0263 | 0,0013 | 0,38 | 0,0263 | 0,0021 | 0,53 | 0,0369 | 0,0031 | 0,53 | 0,0369 | 0,0049 | 0,78 | 0,0422 | 0,0039 | 0,78 | 0,0422 | 0,0061 |
| S06- | Langenwang | Krieglach | 0,45 | 0,0313 | 0,0016 | 0,45 | 0,0313 | 0,0025 | 0,63 | 0,0438 | 0,0037 | 0,63 | 0,0438 | 0,0058 | 0,93 | 0,0501 | 0,0046 | 0,93 | 0,0501 | 0,0073 |
| S06- | Krieglach | Mitterdorf | 1,13 | 0,0791 | 0,0040 | 1,14 | 0,0791 | 0,0064 | 1,59 | 0,1107 | 0,0093 | 1,60 | 0,1107 | 0,0146 | 2,35 | 0,1265 | 0,0117 | 2,35 | 0,1265 | 0,0184 |
| S06- | Mitterdorf | Kindberg Ost | 1,15 | 0,0804 | 0,0041 | 1,16 | 0,0804 | 0,0065 | 1,62 | 0,1126 | 0,0095 | 1,62 | 0,1126 | 0,0149 | 2,39 | 0,1287 | 0,0119 | 2,39 | 0,1287 | 0,0187 |
| S06- | Kindberg Ost | Kindberg West | 0,25 | 0,0173 | 0,0009 | 0,25 | 0,0173 | 0,0014 | 0,35 | 0,0242 | 0,0020 | 0,35 | 0,0242 | 0,0032 | 0,51 | 0,0276 | 0,0026 | 0,51 | 0,0276 | 0,0040 |
| S06- | Kindberg West | Kindberg Dörfel | 0,25 | 0,0172 | 0,0009 | 0,25 | 0,0172 | 0,0014 | 0,35 | 0,0241 | 0,0020 | 0,35 | 0,0241 | 0,0032 | 0,51 | 0,0276 | 0,0026 | 0,51 | 0,0276 | 0,0040 |
| S06- | Kindberg Dörfel | Allerheiligen Mürzhofen | 0,56 | 0,0389 | 0,0020 | 0,56 | 0,0389 | 0,0031 | 0,78 | 0,0544 | 0,0046 | 0,79 | 0,0544 | 0,0072 | 1,15 | 0,0622 | 0,0058 | 1,16 | 0,0622 | 0,0090 |
| S06- | Allerheiligen Mürzhofen | St. Marein | 0,84 | 0,0584 | 0,0030 | 0,84 | 0,0584 | 0,0047 | 1,18 | 0,0817 | 0,0069 | 1,18 | 0,0817 | 0,0108 | 1,73 | 0,0934 | 0,0086 | 1,74 | 0,0934 | 0,0136 |
| S06- | St. Marein | Kapfenberg | 0,59 | 0,0414 | 0,0021 | 0,59 | 0,0414 | 0,0033 | 0,83 | 0,0579 | 0,0049 | 0,84 | 0,0579 | 0,0076 | 1,23 | 0,0662 | 0,0061 | 1,23 | 0,0662 | 0,0096 |
| S06- | Kapfenberg | KN Bruck/Mur | 1,11 | 0,0772 | 0,0039 | 1,11 | 0,0772 | 0,0062 | 1,56 | 0,1081 | 0,0091 | 1,56 | 0,1081 | 0,0143 | 2,29 | 0,1236 | 0,0114 | 2,30 | 0,1236 | 0,0180 |
| S06- | KN Bruck/Mur | ASt Bruck/Mur | 0,95 | 0,0663 | 0,0034 | 0,95 | 0,0663 | 0,0053 | 1,33 | 0,0928 | 0,0078 | 1,34 | 0,0928 | 0,0122 | 1,97 | 0,1060 | 0,0098 | 1,97 | 0,1060 | 0,0154 |
| S06- | ASt Bruck/Mur | Niklasdorf | 0,88 | 0,0612 | 0,0031 | 0,88 | 0,0612 | 0,0049 | 1,23 | 0,0857 | 0,0072 | 1,24 | 0,0857 | 0,0113 | 1,82 | 0,0979 | 0,0091 | 1,82 | 0,0979 | 0,0143 |
| S06- | Niklasdorf | Leoben Ost | 0,94 | 0,0653 | 0,0033 | 0,94 | 0,0653 | 0,0052 | 1,31 | 0,0914 | 0,0077 | 1,32 | 0,0914 | 0,0121 | 1,94 | 0,1045 | 0,0097 | 1,94 | 0,1045 | 0,0152 |
| S06- | Leoben Ost | Leoben West | 1,05 | 0,0731 | 0,0037 | 1,05 | 0,0731 | 0,0059 | 1,47 | 0,1024 | 0,0086 | 1,48 | 0,1024 | 0,0135 | 2,17 | 0,1170 | 0,0108 | 2,18 | 0,1170 | |

| | | | | | | | | | | | | | | | | | | | | |
|------|-----------------------------|-----------------------------|------|--------|--------|------|--------|--------|------|--------|--------|------|--------|--------|------|--------|--------|------|--------|--------|
| S31- | Eisenstadt Mitte | KN Eisenstadt | 0,37 | 0,0261 | 0,0013 | 0,37 | 0,0261 | 0,0021 | 0,52 | 0,0365 | 0,0031 | 0,53 | 0,0365 | 0,0048 | 0,77 | 0,0417 | 0,0039 | 0,78 | 0,0417 | 0,0061 |
| S31- | KN Eisenstadt | Wulkaprodersdorf | 0,50 | 0,0347 | 0,0018 | 0,50 | 0,0347 | 0,0028 | 0,70 | 0,0486 | 0,0041 | 0,70 | 0,0486 | 0,0064 | 1,03 | 0,0555 | 0,0051 | 1,03 | 0,0555 | 0,0081 |
| S31- | Wulkaprodersdorf | KN Mattersburg | 1,41 | 0,0985 | 0,0050 | 1,41 | 0,0985 | 0,0079 | 1,98 | 0,1379 | 0,0116 | 1,99 | 0,1379 | 0,0182 | 2,92 | 0,1576 | 0,0146 | 2,93 | 0,1576 | 0,0229 |
| S31- | KN Mattersburg | Forchtenstein | 1,02 | 0,0713 | 0,0036 | 1,03 | 0,0713 | 0,0057 | 1,44 | 0,0998 | 0,0084 | 1,44 | 0,0998 | 0,0132 | 2,12 | 0,1140 | 0,0106 | 2,12 | 0,1140 | 0,0166 |
| S31- | Forchtenstein | Sieggraben | 1,43 | 0,0996 | 0,0051 | 1,43 | 0,0996 | 0,0080 | 2,01 | 0,1394 | 0,0117 | 2,01 | 0,1394 | 0,0184 | 2,96 | 0,1594 | 0,0148 | 2,96 | 0,1594 | 0,0232 |
| S31- | Sieggraben | Weppersdorf/Kobersdorf | 1,72 | 0,1200 | 0,0061 | 1,73 | 0,1200 | 0,0096 | 2,42 | 0,1680 | 0,0141 | 2,42 | 0,1680 | 0,0222 | 3,56 | 0,1920 | 0,0178 | 3,57 | 0,1920 | 0,0279 |
| S31- | Weppersdorf/Kobersdorf | Weppersdorf/Markt St.Martin | 0,35 | 0,0246 | 0,0013 | 0,35 | 0,0246 | 0,0020 | 0,50 | 0,0345 | 0,0029 | 0,50 | 0,0345 | 0,0046 | 0,73 | 0,0394 | 0,0037 | 0,73 | 0,0394 | 0,0057 |
| S31- | Weppersdorf/Markt St.Martin | Neutal | 0,82 | 0,0570 | 0,0029 | 0,82 | 0,0570 | 0,0046 | 1,15 | 0,0797 | 0,0067 | 1,15 | 0,0797 | 0,0105 | 1,69 | 0,0911 | 0,0084 | 1,70 | 0,0911 | 0,0133 |
| S31- | Neutal | Stoob Süd | 0,71 | 0,0498 | 0,0025 | 0,72 | 0,0498 | 0,0040 | 1,00 | 0,0697 | 0,0058 | 1,01 | 0,0697 | 0,0092 | 1,48 | 0,0796 | 0,0074 | 1,48 | 0,0796 | 0,0116 |
| S31- | Stoob Süd | Oberpullendorf | 0,78 | 0,0543 | 0,0028 | 0,78 | 0,0543 | 0,0044 | 1,09 | 0,0760 | 0,0064 | 1,10 | 0,0760 | 0,0100 | 1,61 | 0,0869 | 0,0080 | 1,62 | 0,0869 | 0,0126 |
| S33- | KN St. Pölten | St. Pölten Ost | 0,42 | 0,0295 | 0,0015 | 0,42 | 0,0295 | 0,0024 | 0,59 | 0,0413 | 0,0035 | 0,60 | 0,0413 | 0,0054 | 0,88 | 0,0472 | 0,0044 | 0,88 | 0,0472 | 0,0069 |
| S33- | St. Pölten Ost | St. Pölten Nord | 0,75 | 0,0521 | 0,0027 | 0,75 | 0,0521 | 0,0042 | 1,05 | 0,0729 | 0,0061 | 1,05 | 0,0729 | 0,0096 | 1,55 | 0,0834 | 0,0077 | 1,55 | 0,0834 | 0,0121 |
| S33- | St. Pölten Nord | Herzogenburg Süd | 0,79 | 0,0552 | 0,0028 | 0,79 | 0,0552 | 0,0044 | 1,11 | 0,0772 | 0,0065 | 1,11 | 0,0772 | 0,0102 | 1,64 | 0,0883 | 0,0082 | 1,64 | 0,0883 | 0,0128 |
| S33- | Herzogenburg Süd | Herzogenburg Stadt | 0,42 | 0,0295 | 0,0015 | 0,42 | 0,0295 | 0,0024 | 0,59 | 0,0412 | 0,0035 | 0,60 | 0,0412 | 0,0054 | 0,87 | 0,0471 | 0,0044 | 0,88 | 0,0471 | 0,0069 |
| S33- | Herzogenburg Stadt | Herzogenburg Nord | 0,23 | 0,0163 | 0,0008 | 0,23 | 0,0163 | 0,0013 | 0,33 | 0,0229 | 0,0019 | 0,33 | 0,0229 | 0,0030 | 0,48 | 0,0261 | 0,0024 | 0,49 | 0,0261 | 0,0038 |
| S33- | Herzogenburg Nord | Traismauer Süd | 1,14 | 0,0795 | 0,0041 | 1,14 | 0,0795 | 0,0064 | 1,60 | 0,1113 | 0,0093 | 1,61 | 0,1113 | 0,0147 | 2,36 | 0,1272 | 0,0118 | 2,37 | 0,1272 | 0,0185 |
| S33- | Traismauer Süd | Traismauer Nord | 0,58 | 0,0404 | 0,0021 | 0,58 | 0,0404 | 0,0032 | 0,81 | 0,0566 | 0,0047 | 0,82 | 0,0566 | 0,0075 | 1,20 | 0,0647 | 0,0060 | 1,20 | 0,0647 | 0,0094 |
| S33- | Traismauer Nord | Jettsdorf | 0,98 | 0,0683 | 0,0035 | 0,98 | 0,0683 | 0,0055 | 1,37 | 0,0956 | 0,0080 | 1,38 | 0,0956 | 0,0126 | 2,03 | 0,1092 | 0,0101 | 2,03 | 0,1092 | 0,0159 |
| S35- | KN Bruck/Mur | Pernegg | 1,20 | 0,0834 | 0,0043 | 1,20 | 0,0834 | 0,0067 | 1,68 | 0,1168 | 0,0098 | 1,69 | 0,1168 | 0,0154 | 2,48 | 0,1335 | 0,0124 | 2,48 | 0,1335 | 0,0194 |
| S35- | Pernegg | Mixnitz/Mautstatt | 0,87 | 0,0607 | 0,0031 | 0,87 | 0,0607 | 0,0049 | 1,22 | 0,0849 | 0,0071 | 1,23 | 0,0849 | 0,0112 | 1,80 | 0,0971 | 0,0090 | 1,81 | 0,0971 | 0,0141 |
| S35- | Mixnitz/Mautstatt | Röthelstein | 1,04 | 0,0727 | 0,0037 | 1,05 | 0,0727 | 0,0058 | 1,46 | 0,1018 | 0,0085 | 1,47 | 0,1018 | 0,0134 | 2,16 | 0,1164 | 0,0108 | 2,17 | 0,1164 | 0,0169 |
| S35- | Röthelstein | Laufnitzdorf | 0,50 | 0,0351 | 0,0018 | 0,50 | 0,0351 | 0,0028 | 0,71 | 0,0491 | 0,0041 | 0,71 | 0,0491 | 0,0065 | 1,04 | 0,0561 | 0,0052 | 1,04 | 0,0561 | 0,0082 |
| S35- | Laufnitzdorf | Rothleiten | 0,57 | 0,0399 | 0,0020 | 0,57 | 0,0399 | 0,0032 | 0,80 | 0,0558 | 0,0047 | 0,81 | 0,0558 | 0,0074 | 1,18 | 0,0638 | 0,0059 | 1,19 | 0,0638 | 0,0093 |
| S35- | Rothleiten | Frohnleiten Nord | 0,36 | 0,0248 | 0,0013 | 0,36 | 0,0248 | 0,0020 | 0,50 | 0,0348 | 0,0029 | 0,50 | 0,0348 | 0,0046 | 0,74 | 0,0397 | 0,0037 | 0,74 | 0,0397 | 0,0058 |
| S35- | Frohnleiten Nord | Frohnleiten | 0,16 | 0,0115 | 0,0006 | 0,16 | 0,0115 | 0,0009 | 0,23 | 0,0160 | 0,0013 | 0,23 | 0,0160 | 0,0021 | 0,34 | 0,0183 | 0,0017 | 0,34 | 0,0183 | 0,0027 |
| S35- | Frohnleiten | Badl Peggau | 1,10 | 0,0770 | 0,0039 | 1,11 | 0,0770 | 0,0062 | 1,55 | 0,1078 | 0,0090 | 1,56 | 0,1078 | 0,0142 | 2,28 | 0,1232 | 0,0114 | 2,29 | 0,1232 | 0,0179 |
| S35- | Badl Peggau | Peggau Mitte | 0,37 | 0,0258 | 0,0013 | 0,37 | 0,0258 | 0,0021 | 0,52 | 0,0361 | 0,0030 | 0,52 | 0,0361 | 0,0048 | 0,76 | 0,0412 | 0,0038 | 0,77 | 0,0412 | 0,0060 |
| S35- | Peggau Mitte | KN Peggau Deutschfeistritz | 0,77 | 0,0536 | 0,0027 | 0,77 | 0,0536 | 0,0043 | 1,08 | 0,0751 | 0,0063 | 1,08 | 0,0751 | 0,0099 | 1,59 | 0,0858 | 0,0079 | 1,60 | 0,0858 | 0,0125 |
| S36- | KN St. Michael | St. Stefan ob Leoben | 0,63 | 0,0442 | 0,0023 | 0,64 | 0,0442 | 0,0035 | 0,89 | 0,0619 | 0,0052 | 0,89 | 0,0619 | 0,0082 | 1,31 | 0,0707 | 0,0065 | 1,31 | 0,0707 | 0,0103 |
| S36- | St. Stefan ob Leoben | Kraubath | 0,68 | 0,0475 | 0,0024 | 0,68 | 0,0475 | 0,0038 | 0,96 | 0,0665 | 0,0056 | 0,96 | 0,0665 | 0,0088 | 1,41 | 0,0760 | 0,0070 | 1,41 | 0,0760 | 0,0111 |
| S36- | Kraubath | Feistritz St. Lorenzen | 1,20 | 0,0834 | 0,0043 | 1,20 | 0,0834 | 0,0067 | 1,68 | 0,1167 | 0,0098 | 1,68 | 0,1167 | 0,0154 | 2,47 | 0,1334 | 0,0124 | 2,48 | 0,1334 | 0,0194 |
| S36- | Feistritz St. Lorenzen | Knittelfeld Ost | 1,37 | 0,0957 | 0,0049 | 1,38 | 0,0957 | 0,0077 | 1,93 | 0,1340 | 0,0112 | 1,93 | 0,1340 | 0,0177 | 2,84 | 0,1532 | 0,0142 | 2,85 | 0,1532 | 0,0223 |
| S36- | Knittelfeld Ost | Knittelfeld West | 0,58 | 0,0406 | 0,0021 | 0,58 | 0,0406 | 0,0033 | 0,82 | 0,0568 | 0,0048 | 0,82 | 0,0568 | 0,0075 | 1,20 | 0,0649 | 0,0060 | 1,21 | 0,0649 | 0,0095 |
| S36- | Knittelfeld West | Zeitweg Ost Spielberg | 0,18 | 0,0127 | 0,0006 | 0,18 | 0,0127 | 0,0010 | 0,26 | 0,0177 | 0,0015 | 0,26 | 0,0177 | 0,0023 | 0,38 | 0,0203 | 0,0019 | 0,38 | 0,0203 | 0,0030 |
| S36- | Zeitweg Ost Spielberg | Zeitweg West | 1,18 | 0,0825 | 0,0042 | 1,19 | 0,0825 | 0,0066 | 1,66 | 0,1155 | 0,0097 | 1,67 | 0,1155 | 0,0152 | 2,45 | 0,1320 | 0,0122 | 2,45 | 0,1320 | 0,0192 |
| S36- | Zeitweg West | Judenburg Ost Fohnsdorf | 0,60 | 0,0415 | 0,0021 | 0,60 | 0,0415 | 0,0033 | 0,84 | 0,0581 | 0,0049 | 0,84 | 0,0581 | 0,0077 | 1,23 | 0,0664 | 0,0061 | 1,23 | 0,0664 | 0,0097 |
| S36- | Judenburg Ost Fohnsdorf | Judenburg West | 0,92 | 0,0643 | 0,0033 | 0,93 | 0,0643 | 0,0052 | 1,30 | 0,0901 | 0,0076 | 1,30 | 0,0901 | 0,0119 | 1,91 | 0,1029 | 0,0095 | 1,91 | 0,1029 | 0,0150 |
| S36- | As B317 (prov.) | St. Georgen Ost | 0,10 | 0,0067 | 0,0003 | 0,10 | 0,0067 | 0,0005 | 0,14 | 0,0094 | 0,0008 | 0,14 | 0,0094 | 0,0012 | 0,20 | 0,0108 | 0,0010 | 0,20 | 0,0108 | 0,0016 |
| S36- | St. Georgen Ost | St. Georgen West | 0,18 | 0,0125 | 0,0006 | 0,18 | 0,0125 | 0,0010 | 0,25 | 0,0174 | 0,0015 | 0,25 | 0,0174 | 0,0023 | 0,37 | 0,0199 | 0,0018 | 0,37 | 0,0199 | 0,0029 |
| S37- | St. Veit Nord | St. Veit Mitte / Brückl | 0,56 | 0,0390 | 0,0020 | 0,56 | 0,0390 | 0,0031 | 0,79 | 0,0546 | 0,0046 | 0,79 | 0,0546 | 0,0072 | 1,16 | 0,0624 | 0,0058 | 1,16 | 0,0624 | 0,0091 |
| S37- | St. Veit Mitte / Brückl | St. Veit Süd | 0,48 | 0,0332 | 0,0017 | 0,48 | 0,0332 | 0,0027 | 0,67 | 0,0464 | 0,0039 | 0,67 | 0,0464 | 0,0061 | 0,98 | 0,0531 | 0,0049 | 0,99 | 0,0531 | 0,0077 |
| S37- | St. Veit Süd | St. Veit Industriegebiet | 0,36 | 0,0249 | 0,0013 | 0,36 | 0,0249 | 0,0020 | 0,50 | 0,0349 | 0,0029 | 0,50 | 0,0349 | 0,0046 | 0,74 | 0,0399 | 0,0037 | 0,74 | 0,0399 | 0,0058 |
| S37- | St. Veit Industriegebiet | Maria Saal | 1,26 | 0,0875 | 0,0045 | 1,26 | 0,0875 | 0,0070 | 1,76 | 0,1225 | 0,0103 | 1,77 | 0,1225 | 0,0162 | 2,60 | 0,1400 | 0,0130 | 2,60 | 0,1400 | 0,0204 |
| S37- | Maria Saal | Karnburg | 0,45 | 0,0312 | 0,0016 | 0,45 | 0,0312 | 0,0025 | 0,63 | 0,0437 | 0,0037 | 0,63 | 0,0437 | 0,0058 | 0,93 | 0,0500 | 0,0046 | 0,93 | 0,0500 | 0,0073 |
| S37- | Karnburg | Klagenfurt Nord | 0,39 | 0,0273 | 0,0014 | 0,39 | 0,0273 | 0,0022 | 0,55 | 0,0382 | 0,0032 | 0,55 | 0,0382 | 0,0050 | 0,81 | 0,0436 | 0,0040 | 0,81 | 0,0436 | 0,0064 |
| A01- | Preßbaum | Wien Auhof | 2,74 | 0,1908 | 0,0098 | 2,74 | 0,1908 | 0,0153 | 3,84 | 0,2672 | 0,0224 | 3,86 | 0,2672 | 0,0352 | 5,66 | 0,3053 | 0,0283 | 5,68 | 0,3053 | 0,0444 |
| A01- | KN Steinhäusl | Preßbaum | 1,55 | 0,1078 | 0,0055 | 1,55 | 0,1078 | 0,0087 | 2,17 | 0,1510 | 0,0127 | 2,18 | 0,1510 | 0,0199 | 3,20 | 0,1726 | 0,0160 | 3,21 | 0,1726 | 0,0251 |
| A01- | Altlangbach | KN Steinhäusl | 0,91 | 0,0634 | 0,0032 | 0,91 | 0,0634 | 0,0051 | 1,28 | 0,0888 | 0,0075 | 1,28 | 0,0888 | 0,0117 | 1,88 | 0,1014 | 0,0094 | 1,89 | 0,1014 | 0,0148 |
| A01- | St. Christophen | Altlangbach | 1,09 | 0,0756 | 0,0039 | 1,09 | 0,0756 | 0,0061 | 1,52 | 0,1059 | 0,0089 | 1,53 | 0,1059 | 0,0140 | 2,24 | 0,1210 | 0,0112 | 2,25 | 0,1210 | 0,0176 |
| A01- | Böheimkirchen | St. Christophen | 1,30 | 0,0907 | 0,0046 | 1,30 | 0,0907 | 0,0073 | 1,83 | 0,1270 | 0,0107 | 1,83 | 0,1270 | 0,0167 | 2,69 | 0,1451 | 0,0134 | 2,70 | 0,1451 | 0,0211 |
| A01- | KN St. Pölten | Böheimkirchen | 1,27 | 0,0887 | 0,0045 | 1,28 | 0,0887 | 0,0071 | 1,79 | 0,1242 | 0,0104 | 1,79 | 0,1242 | 0,0164 | 2,63 | 0,1419 | 0,0131 | 2,64 | 0,1419 | 0,0207 |
| A01- | St. Pölten Süd | KN St. Pölten | 0,90 | 0,0629 | 0,0032 | 0,90 | 0,0629 | 0,0051 | 1,27 | 0,0881 | 0,0074 | 1,27 | 0,0881 | 0,0116 | 1,87 | 0,1007 | 0,0093 | 1,87 | 0,1007 | 0,0147 |
| A01- | Loosdorf | St. Pölten Süd | 3,13 | 0,2182 | 0,0111 | 3,14 | 0,2182 | 0,0175 | 4,39 | 0,3055 | 0,0256 | 4,41 | 0,3055 | 0,0403 | 6,48 | 0,3491 | 0,0323 | 6,49 | 0,3491 | 0,0508 |
| A01- | Melk | Loosdorf | 1,15 | 0,0800 | 0,0041 | 1,15 | 0,0800 | 0,0064 | 1,61 | 0,1119 | 0,0094 | 1,62 | 0,1119 | 0,0148 | 2,37 | 0,1279 | 0,0118 | 2,38 | 0,1279 | 0,0186 |
| A01- | Pöchlarn | Melk | 2,03 | 0,1417 | 0,0072 | 2,04 | 0,1417 | 0,0114 | 2,85 | 0,1984 | 0,0167 | 2,86 | 0,1984 | 0,0262 | 4,21 | 0,2268 | 0,0210 | 4,22 | 0,2268 | 0,0330 |
| A01- | Ybbs Wieselburg | Pöchlarn | 1,88 | 0,1308 | 0,0067 | 1,88 | 0,1308 | 0,0105 | 2,63 | 0,1831 | 0,0154 | 2,64 | 0,1831 | 0,0242 | 3,88 | 0,2093 | 0,0194 | 3,89 | 0,2093 | 0,0305 |
| A01- | Amstetten Ost | Ybbs Wieselburg | 1,69 | 0,1175 | 0 | | | | | | | | | | | | | | | |

| | | | | | | | | | | | | | | | | | | | | |
|------|----------------------------|----------------------------|------|--------|--------|------|--------|--------|------|--------|--------|------|--------|--------|------|--------|--------|------|--------|--------|
| A01- | Laakirchen West | Laakirchen Ost | 0,71 | 0,0496 | 0,0025 | 0,71 | 0,0496 | 0,0040 | 1,00 | 0,0694 | 0,0058 | 1,00 | 0,0694 | 0,0092 | 1,47 | 0,0794 | 0,0073 | 1,48 | 0,0794 | 0,0115 |
| A01- | Regau | Laakirchen West | 1,40 | 0,0972 | 0,0050 | 1,40 | 0,0972 | 0,0078 | 1,96 | 0,1361 | 0,0114 | 1,96 | 0,1361 | 0,0180 | 2,89 | 0,1555 | 0,0144 | 2,89 | 0,1555 | 0,0226 |
| A01- | Schörfling | Regau | 1,83 | 0,1277 | 0,0065 | 1,84 | 0,1277 | 0,0103 | 2,57 | 0,1788 | 0,0150 | 2,58 | 0,1788 | 0,0236 | 3,79 | 0,2044 | 0,0189 | 3,80 | 0,2044 | 0,0297 |
| A01- | Seewalchen | Schörfling | 0,28 | 0,0198 | 0,0010 | 0,28 | 0,0198 | 0,0016 | 0,40 | 0,0277 | 0,0023 | 0,40 | 0,0277 | 0,0037 | 0,59 | 0,0317 | 0,0029 | 0,59 | 0,0317 | 0,0046 |
| A01- | St. Georgen | Seewalchen | 1,66 | 0,1158 | 0,0059 | 1,67 | 0,1158 | 0,0093 | 2,33 | 0,1621 | 0,0136 | 2,34 | 0,1621 | 0,0214 | 3,44 | 0,1853 | 0,0172 | 3,45 | 0,1853 | 0,0270 |
| A01- | Oberwang | St. Georgen | 2,22 | 0,1544 | 0,0079 | 2,22 | 0,1544 | 0,0124 | 3,11 | 0,2162 | 0,0181 | 3,12 | 0,2162 | 0,0285 | 4,58 | 0,2470 | 0,0229 | 4,60 | 0,2470 | 0,0360 |
| A01- | Mondsee | Oberwang | 2,04 | 0,1421 | 0,0073 | 2,04 | 0,1421 | 0,0114 | 2,86 | 0,1990 | 0,0167 | 2,87 | 0,1990 | 0,0262 | 4,22 | 0,2274 | 0,0211 | 4,23 | 0,2274 | 0,0331 |
| A01- | Thalgau | Mondsee | 1,88 | 0,1310 | 0,0067 | 1,88 | 0,1310 | 0,0105 | 2,64 | 0,1834 | 0,0154 | 2,65 | 0,1834 | 0,0242 | 3,89 | 0,2096 | 0,0194 | 3,90 | 0,2096 | 0,0305 |
| A01- | Wallersee | Thalgau | 1,43 | 0,0998 | 0,0051 | 1,44 | 0,0998 | 0,0080 | 2,01 | 0,1398 | 0,0117 | 2,02 | 0,1398 | 0,0184 | 2,96 | 0,1597 | 0,0148 | 2,97 | 0,1597 | 0,0232 |
| A01- | Salzburg Nord | Wallersee | 1,39 | 0,0966 | 0,0049 | 1,39 | 0,0966 | 0,0078 | 1,95 | 0,1353 | 0,0114 | 1,95 | 0,1353 | 0,0178 | 2,87 | 0,1546 | 0,0143 | 2,88 | 0,1546 | 0,0225 |
| A01- | Salzburg Bergheim-West | Salzburg Nord | 0,31 | 0,0218 | 0,0011 | 0,31 | 0,0218 | 0,0017 | 0,44 | 0,0305 | 0,0026 | 0,44 | 0,0305 | 0,0040 | 0,65 | 0,0349 | 0,0032 | 0,65 | 0,0349 | 0,0051 |
| A01- | Messe | Salzburg Bergheim-West | 0,15 | 0,0104 | 0,0005 | 0,15 | 0,0104 | 0,0008 | 0,21 | 0,0146 | 0,0012 | 0,21 | 0,0146 | 0,0019 | 0,31 | 0,0167 | 0,0015 | 0,31 | 0,0167 | 0,0024 |
| A01- | Salzburg Mitte Freilassing | Messe | 0,20 | 0,0139 | 0,0007 | 0,20 | 0,0139 | 0,0011 | 0,28 | 0,0194 | 0,0016 | 0,28 | 0,0194 | 0,0026 | 0,41 | 0,0222 | 0,0021 | 0,41 | 0,0222 | 0,0032 |
| A01- | Kleßheim | Salzburg Mitte Freilassing | 0,24 | 0,0170 | 0,0009 | 0,24 | 0,0170 | 0,0014 | 0,34 | 0,0238 | 0,0020 | 0,34 | 0,0238 | 0,0031 | 0,51 | 0,0272 | 0,0025 | 0,51 | 0,0272 | 0,0040 |
| A01- | Siezenheim | Kleßheim | 0,34 | 0,0236 | 0,0012 | 0,34 | 0,0236 | 0,0019 | 0,48 | 0,0330 | 0,0028 | 0,48 | 0,0330 | 0,0044 | 0,70 | 0,0378 | 0,0035 | 0,70 | 0,0378 | 0,0055 |
| A01- | Flughafen | Siezenheim | 0,17 | 0,0119 | 0,0006 | 0,17 | 0,0119 | 0,0010 | 0,24 | 0,0166 | 0,0014 | 0,24 | 0,0166 | 0,0022 | 0,35 | 0,0190 | 0,0018 | 0,35 | 0,0190 | 0,0028 |
| A01- | Wals Salzburg West | Flughafen | 0,21 | 0,0145 | 0,0007 | 0,21 | 0,0145 | 0,0012 | 0,29 | 0,0203 | 0,0017 | 0,29 | 0,0203 | 0,0027 | 0,43 | 0,0232 | 0,0021 | 0,43 | 0,0232 | 0,0034 |
| A01- | KN Salzburg | Wals Salzburg West | 0,31 | 0,0217 | 0,0011 | 0,31 | 0,0217 | 0,0017 | 0,44 | 0,0304 | 0,0026 | 0,44 | 0,0304 | 0,0040 | 0,64 | 0,0347 | 0,0032 | 0,65 | 0,0347 | 0,0051 |
| A01- | Staatsgrenze Walsberg | KN Salzburg | 0,53 | 0,0369 | 0,0019 | 0,53 | 0,0369 | 0,0030 | 0,74 | 0,0517 | 0,0043 | 0,75 | 0,0517 | 0,0068 | 1,09 | 0,0590 | 0,0055 | 1,10 | 0,0590 | 0,0086 |
| A02- | KN Vösendorf | KN Wien Inzersdorf | 0,66 | 0,0462 | 0,0024 | 0,66 | 0,0462 | 0,0037 | 0,93 | 0,0646 | 0,0054 | 0,93 | 0,0646 | 0,0085 | 1,37 | 0,0739 | 0,0068 | 1,37 | 0,0739 | 0,0108 |
| A02- | Mödling | KN Vösendorf | 0,45 | 0,0314 | 0,0016 | 0,45 | 0,0314 | 0,0025 | 0,63 | 0,0439 | 0,0037 | 0,63 | 0,0439 | 0,0058 | 0,93 | 0,0502 | 0,0047 | 0,93 | 0,0502 | 0,0073 |
| A02- | Wr. Neudorf | Mödling | 0,43 | 0,0299 | 0,0015 | 0,43 | 0,0299 | 0,0024 | 0,60 | 0,0419 | 0,0035 | 0,61 | 0,0419 | 0,0055 | 0,89 | 0,0479 | 0,0044 | 0,89 | 0,0479 | 0,0070 |
| A02- | Wr. Neudorf IZ/Süd | Wr. Neudorf | 0,47 | 0,0329 | 0,0017 | 0,47 | 0,0329 | 0,0026 | 0,66 | 0,0461 | 0,0039 | 0,67 | 0,0461 | 0,0061 | 0,98 | 0,0527 | 0,0049 | 0,98 | 0,0527 | 0,0077 |
| A02- | KN Guntramsdorf | Wr. Neudorf IZ/Süd | 0,69 | 0,0480 | 0,0025 | 0,69 | 0,0480 | 0,0039 | 0,97 | 0,0672 | 0,0056 | 0,97 | 0,0672 | 0,0089 | 1,43 | 0,0769 | 0,0071 | 1,43 | 0,0769 | 0,0112 |
| A02- | Traiskirchen | KN Guntramsdorf | 0,77 | 0,0535 | 0,0027 | 0,77 | 0,0535 | 0,0043 | 1,08 | 0,0749 | 0,0063 | 1,08 | 0,0749 | 0,0099 | 1,59 | 0,0856 | 0,0079 | 1,59 | 0,0856 | 0,0125 |
| A02- | Baden | Traiskirchen | 0,43 | 0,0298 | 0,0015 | 0,43 | 0,0298 | 0,0024 | 0,60 | 0,0417 | 0,0035 | 0,60 | 0,0417 | 0,0055 | 0,88 | 0,0476 | 0,0044 | 0,89 | 0,0476 | 0,0069 |
| A02- | Bad Vöslau | Baden | 0,70 | 0,0489 | 0,0025 | 0,70 | 0,0489 | 0,0039 | 0,98 | 0,0685 | 0,0057 | 0,99 | 0,0685 | 0,0090 | 1,45 | 0,0783 | 0,0072 | 1,46 | 0,0783 | 0,0114 |
| A02- | Kottingbrunn | Bad Vöslau | 0,51 | 0,0353 | 0,0018 | 0,51 | 0,0353 | 0,0028 | 0,71 | 0,0494 | 0,0042 | 0,71 | 0,0494 | 0,0065 | 1,05 | 0,0565 | 0,0052 | 1,05 | 0,0565 | 0,0082 |
| A02- | Leobersdorf | Kottingbrunn | 0,44 | 0,0310 | 0,0016 | 0,45 | 0,0310 | 0,0025 | 0,62 | 0,0434 | 0,0036 | 0,63 | 0,0434 | 0,0057 | 0,92 | 0,0496 | 0,0046 | 0,92 | 0,0496 | 0,0072 |
| A02- | Wöllersdorf | Leobersdorf | 1,77 | 0,1236 | 0,0063 | 1,78 | 0,1236 | 0,0099 | 2,49 | 0,1731 | 0,0145 | 2,50 | 0,1731 | 0,0228 | 3,67 | 0,1978 | 0,0183 | 3,68 | 0,1978 | 0,0288 |
| A02- | Wr. Neustadt West | Wöllersdorf | 1,15 | 0,0803 | 0,0041 | 1,15 | 0,0803 | 0,0064 | 1,62 | 0,1124 | 0,0094 | 1,62 | 0,1124 | 0,0148 | 2,38 | 0,1285 | 0,0119 | 2,39 | 0,1285 | 0,0187 |
| A02- | KN Wr. Neustadt | Wr. Neustadt West | 0,46 | 0,0322 | 0,0016 | 0,46 | 0,0322 | 0,0026 | 0,65 | 0,0450 | 0,0038 | 0,65 | 0,0450 | 0,0059 | 0,95 | 0,0514 | 0,0048 | 0,96 | 0,0514 | 0,0075 |
| A02- | KN Seebenstein | KN Wr. Neustadt | 2,09 | 0,1455 | 0,0074 | 2,09 | 0,1455 | 0,0117 | 2,93 | 0,2037 | 0,0171 | 2,94 | 0,2037 | 0,0269 | 4,32 | 0,2328 | 0,0216 | 4,33 | 0,2328 | 0,0339 |
| A02- | Grimmenstein | KN Seebenstein | 1,78 | 0,1241 | 0,0063 | 1,78 | 0,1241 | 0,0100 | 2,50 | 0,1738 | 0,0146 | 2,51 | 0,1738 | 0,0229 | 3,68 | 0,1986 | 0,0184 | 3,69 | 0,1986 | 0,0289 |
| A02- | Edlitz | Grimmenstein | 0,49 | 0,0344 | 0,0018 | 0,49 | 0,0344 | 0,0028 | 0,69 | 0,0481 | 0,0040 | 0,69 | 0,0481 | 0,0063 | 1,02 | 0,0550 | 0,0051 | 1,02 | 0,0550 | 0,0080 |
| A02- | Krumbach | Edlitz | 1,52 | 0,1061 | 0,0054 | 1,53 | 0,1061 | 0,0085 | 2,14 | 0,1485 | 0,0125 | 2,14 | 0,1485 | 0,0196 | 3,15 | 0,1698 | 0,0157 | 3,16 | 0,1698 | 0,0247 |
| A02- | Zöbern | Krumbach | 0,80 | 0,0560 | 0,0029 | 0,81 | 0,0560 | 0,0045 | 1,13 | 0,0784 | 0,0066 | 1,13 | 0,0784 | 0,0103 | 1,66 | 0,0896 | 0,0083 | 1,67 | 0,0896 | 0,0130 |
| A02- | Aspang | Zöbern | 0,11 | 0,0073 | 0,0004 | 0,11 | 0,0073 | 0,0006 | 0,15 | 0,0102 | 0,0009 | 0,15 | 0,0102 | 0,0014 | 0,22 | 0,0117 | 0,0011 | 0,22 | 0,0117 | 0,0017 |
| A02- | Schäftern | Aspang | 1,27 | 0,0886 | 0,0045 | 1,27 | 0,0886 | 0,0071 | 1,78 | 0,1241 | 0,0104 | 1,79 | 0,1241 | 0,0164 | 2,63 | 0,1418 | 0,0131 | 2,64 | 0,1418 | 0,0206 |
| A02- | Pinggau/Friedberg | Schäftern | 1,52 | 0,1059 | 0,0054 | 1,52 | 0,1059 | 0,0085 | 2,13 | 0,1482 | 0,0124 | 2,14 | 0,1482 | 0,0195 | 3,14 | 0,1694 | 0,0157 | 3,15 | 0,1694 | 0,0246 |
| A02- | Pinkafeld | Pinggau/Friedberg | 1,03 | 0,0717 | 0,0037 | 1,03 | 0,0717 | 0,0058 | 1,44 | 0,1004 | 0,0084 | 1,45 | 0,1004 | 0,0132 | 2,13 | 0,1147 | 0,0106 | 2,13 | 0,1147 | 0,0167 |
| A02- | Lafnitzal/Oberwart | Pinkafeld | 2,15 | 0,1495 | 0,0076 | 2,15 | 0,1495 | 0,0120 | 3,01 | 0,2093 | 0,0176 | 3,02 | 0,2093 | 0,0276 | 4,44 | 0,2392 | 0,0221 | 4,45 | 0,2392 | 0,0348 |
| A02- | Hartberg | Lafnitzal/Oberwart | 0,85 | 0,0590 | 0,0030 | 0,85 | 0,0590 | 0,0047 | 1,19 | 0,0826 | 0,0069 | 1,19 | 0,0826 | 0,0109 | 1,75 | 0,0944 | 0,0087 | 1,76 | 0,0944 | 0,0137 |
| A02- | Sebersdorf/Bad Waltersdorf | Hartberg | 2,14 | 0,1493 | 0,0076 | 2,15 | 0,1493 | 0,0120 | 3,01 | 0,2090 | 0,0175 | 3,02 | 0,2090 | 0,0276 | 4,43 | 0,2389 | 0,0221 | 4,44 | 0,2389 | 0,0348 |
| A02- | Ilz Fürstenfeld | Sebersdorf/Bad Waltersdorf | 2,40 | 0,1674 | 0,0086 | 2,41 | 0,1674 | 0,0134 | 3,37 | 0,2344 | 0,0197 | 3,38 | 0,2344 | 0,0309 | 4,97 | 0,2678 | 0,0248 | 4,98 | 0,2678 | 0,0390 |
| A02- | Sinabelkirchen | Ilz Fürstenfeld | 2,21 | 0,1539 | 0,0079 | 2,21 | 0,1539 | 0,0124 | 3,10 | 0,2154 | 0,0181 | 3,11 | 0,2154 | 0,0284 | 4,57 | 0,2462 | 0,0228 | 4,58 | 0,2462 | 0,0358 |
| A02- | Gleisdorf Süd | Sinabelkirchen | 1,45 | 0,1014 | 0,0052 | 1,46 | 0,1014 | 0,0081 | 2,04 | 0,1419 | 0,0119 | 2,05 | 0,1419 | 0,0187 | 3,01 | 0,1622 | 0,0150 | 3,02 | 0,1622 | 0,0236 |
| A02- | Gleisdorf West | Gleisdorf Süd | 0,63 | 0,0440 | 0,0022 | 0,63 | 0,0440 | 0,0035 | 0,89 | 0,0616 | 0,0052 | 0,89 | 0,0616 | 0,0081 | 1,31 | 0,0704 | 0,0065 | 1,31 | 0,0704 | 0,0102 |
| A02- | Laßnitzhöhe | Gleisdorf West | 1,65 | 0,1153 | 0,0059 | 1,66 | 0,1153 | 0,0093 | 2,32 | 0,1614 | 0,0135 | 2,33 | 0,1614 | 0,0213 | 3,42 | 0,1845 | 0,0171 | 3,43 | 0,1845 | 0,0268 |
| A02- | KN Graz Ost | Laßnitzhöhe | 2,07 | 0,1442 | 0,0074 | 2,07 | 0,1442 | 0,0116 | 2,90 | 0,2019 | 0,0170 | 2,91 | 0,2019 | 0,0266 | 4,28 | 0,2308 | 0,0214 | 4,29 | 0,2308 | 0,0336 |
| A02- | Graz Feldkirchen Flughafen | KN Graz Ost | 0,74 | 0,0519 | 0,0027 | 0,75 | 0,0519 | 0,0042 | 1,05 | 0,0727 | 0,0061 | 1,05 | 0,0727 | 0,0096 | 1,54 | 0,0830 | 0,0077 | 1,54 | 0,0830 | 0,0121 |
| A02- | KN Graz West | Graz Feldkirchen Flughafen | 0,50 | 0,0347 | 0,0018 | 0,50 | 0,0347 | 0,0028 | 0,70 | 0,0486 | 0,0041 | 0,70 | 0,0486 | 0,0064 | 1,03 | 0,0556 | 0,0051 | 1,03 | 0,0556 | 0,0081 |
| A02- | Unterprenstätten | KN Graz West | 0,60 | 0,0418 | 0,0021 | 0,60 | 0,0418 | 0,0034 | 0,84 | 0,0585 | 0,0049 | 0,84 | 0,0585 | 0,0077 | 1,24 | 0,0668 | 0,0062 | 1,24 | 0,0668 | 0,0097 |
| A02- | Lieboch | Unterprenstätten | 0,93 | 0,0649 | 0,0033 | 0,93 | 0,0649 | 0,0052 | 1,31 | 0,0908 | 0,0076 | 1,31 | 0,0908 | 0,0120 | 1,93 | 0,1038 | 0,0096 | 1,93 | 0,1038 | 0,0151 |
| A02- | Mooskirchen | Lieboch | 1,28 | 0,0894 | 0,0046 | 1,29 | 0,0894 | 0,0072 | 1,80 | 0,1252 | 0,0105 | 1,81 | 0,1252 | 0,0165 | 2,65 | 0,1431 | 0,0133 | 2,66 | 0,1431 | 0,0208 |
| A02- | Steinberg | Mooskirchen | 1,33 | 0,0926 | 0,0047 | 1,33 | 0,0926 | 0,0074 | 1,86 | 0,1296 | 0,0109 | 1,87 | 0,1296 | 0,0171 | 2,75 | 0,1481 | 0,0137 | 2,76 | 0,1481 | 0,0216 |
| A02- | Modriach | Steinberg | 3,32 | 0,2314 | 0,0118 | 3,33 | 0,2314 | 0,0186 | 4,66 | 0,3240 | 0,0272 | 4,68 | | | | | | | | |

| | | | | | | | | | | | | | | | | | | | | |
|------|----------------------------------|----------------------------------|------|--------|--------|------|--------|--------|------|--------|--------|------|--------|--------|------|--------|--------|------|--------|--------|
| A02- | Velden West | Velden Ost | 0,73 | 0,0511 | 0,0026 | 0,74 | 0,0511 | 0,0041 | 1,03 | 0,0716 | 0,0060 | 1,03 | 0,0716 | 0,0094 | 1,52 | 0,0818 | 0,0076 | 1,52 | 0,0818 | 0,0119 |
| A02- | Wernberg | Velden West | 1,21 | 0,0845 | 0,0043 | 1,22 | 0,0845 | 0,0068 | 1,70 | 0,1183 | 0,0099 | 1,71 | 0,1183 | 0,0156 | 2,51 | 0,1352 | 0,0125 | 2,52 | 0,1352 | 0,0197 |
| A02- | KN Villach | Wernberg | 0,64 | 0,0449 | 0,0023 | 0,65 | 0,0449 | 0,0036 | 0,90 | 0,0629 | 0,0053 | 0,91 | 0,0629 | 0,0083 | 1,33 | 0,0719 | 0,0067 | 1,34 | 0,0719 | 0,0105 |
| A02- | Villach Faaker See | KN Villach | 0,50 | 0,0349 | 0,0018 | 0,50 | 0,0349 | 0,0028 | 0,70 | 0,0489 | 0,0041 | 0,71 | 0,0489 | 0,0065 | 1,04 | 0,0559 | 0,0052 | 1,04 | 0,0559 | 0,0081 |
| A02- | Villach Warmbad | Villach Faaker See | 1,15 | 0,0798 | 0,0041 | 1,15 | 0,0798 | 0,0064 | 1,61 | 0,1117 | 0,0094 | 1,61 | 0,1117 | 0,0147 | 2,37 | 0,1277 | 0,0118 | 2,38 | 0,1277 | 0,0186 |
| A02- | Hermagor | Villach Warmbad | 2,08 | 0,1447 | 0,0074 | 2,08 | 0,1447 | 0,0116 | 2,91 | 0,2025 | 0,0170 | 2,92 | 0,2025 | 0,0267 | 4,29 | 0,2315 | 0,0214 | 4,31 | 0,2315 | 0,0337 |
| A02- | Arnoldstein | Hermagor | 0,49 | 0,0345 | 0,0018 | 0,50 | 0,0345 | 0,0028 | 0,69 | 0,0482 | 0,0040 | 0,70 | 0,0482 | 0,0064 | 1,02 | 0,0551 | 0,0051 | 1,03 | 0,0551 | 0,0080 |
| A02- | Staatsgrenze Arnoldstein | Arnoldstein | 0,76 | 0,0528 | 0,0027 | 0,76 | 0,0528 | 0,0042 | 1,06 | 0,0740 | 0,0062 | 1,07 | 0,0740 | 0,0098 | 1,57 | 0,0845 | 0,0078 | 1,57 | 0,0845 | 0,0123 |
| A03- | Münchendorf/Achau | KN Guntramsdorf | 0,20 | 0,0137 | 0,0007 | 0,20 | 0,0137 | 0,0011 | 0,28 | 0,0192 | 0,0016 | 0,28 | 0,0192 | 0,0025 | 0,41 | 0,0219 | 0,0020 | 0,41 | 0,0219 | 0,0032 |
| A03- | Ebreichsdorf Nord | Münchendorf/Achau | 0,83 | 0,0577 | 0,0029 | 0,83 | 0,0577 | 0,0046 | 1,16 | 0,0808 | 0,0068 | 1,17 | 0,0808 | 0,0107 | 1,71 | 0,0924 | 0,0086 | 1,72 | 0,0924 | 0,0134 |
| A03- | Ebreichsdorf West | Ebreichsdorf Nord | 0,68 | 0,0471 | 0,0024 | 0,68 | 0,0471 | 0,0038 | 0,95 | 0,0660 | 0,0055 | 0,95 | 0,0660 | 0,0087 | 1,40 | 0,0754 | 0,0070 | 1,40 | 0,0754 | 0,0110 |
| A03- | Pottendorf | Ebreichsdorf West | 0,89 | 0,0618 | 0,0032 | 0,89 | 0,0618 | 0,0050 | 1,25 | 0,0866 | 0,0073 | 1,25 | 0,0866 | 0,0114 | 1,83 | 0,0989 | 0,0092 | 1,84 | 0,0989 | 0,0144 |
| A03- | Hornstein | Pottendorf | 1,46 | 0,1015 | 0,0052 | 1,46 | 0,1015 | 0,0082 | 2,04 | 0,1421 | 0,0119 | 2,05 | 0,1421 | 0,0187 | 3,01 | 0,1624 | 0,0150 | 3,02 | 0,1624 | 0,0236 |
| A03- | Müllendorf | Hornstein | 0,95 | 0,0665 | 0,0034 | 0,96 | 0,0665 | 0,0053 | 1,34 | 0,0931 | 0,0078 | 1,34 | 0,0931 | 0,0123 | 1,97 | 0,1064 | 0,0099 | 1,98 | 0,1064 | 0,0155 |
| A03- | KN Eisenstadt | Müllendorf | 0,80 | 0,0556 | 0,0028 | 0,80 | 0,0556 | 0,0045 | 1,12 | 0,0779 | 0,0065 | 1,12 | 0,0779 | 0,0103 | 1,65 | 0,0890 | 0,0082 | 1,66 | 0,0890 | 0,0129 |
| A031 | Siegendorf | KN Eisenstadt | 0,63 | 0,0438 | 0,0022 | 0,63 | 0,0438 | 0,0035 | 0,88 | 0,0614 | 0,0052 | 0,89 | 0,0614 | 0,0081 | 1,30 | 0,0701 | 0,0065 | 1,30 | 0,0701 | 0,0102 |
| A041 | KN Wien Prater | Stadionbrücke | 0,12 | 0,0081 | 0,0004 | 0,12 | 0,0081 | 0,0006 | 0,16 | 0,0113 | 0,0009 | 0,16 | 0,0113 | 0,0015 | 0,24 | 0,0129 | 0,0012 | 0,24 | 0,0129 | 0,0019 |
| A04- | Wien Simmeringer Haide | KN Wien Prater | 0,80 | 0,0556 | 0,0028 | 0,80 | 0,0556 | 0,0045 | 1,12 | 0,0778 | 0,0065 | 1,12 | 0,0778 | 0,0103 | 1,65 | 0,0889 | 0,0082 | 1,65 | 0,0889 | 0,0129 |
| A04- | KN Schwechat | Wien Simmeringer Haide | 0,72 | 0,0499 | 0,0025 | 0,72 | 0,0499 | 0,0040 | 1,00 | 0,0698 | 0,0059 | 1,01 | 0,0698 | 0,0092 | 1,48 | 0,0798 | 0,0074 | 1,48 | 0,0798 | 0,0116 |
| A04- | Flughafen Wien Schwechat | KN Schwechat | 1,03 | 0,0720 | 0,0037 | 1,04 | 0,0720 | 0,0058 | 1,45 | 0,1008 | 0,0085 | 1,46 | 0,1008 | 0,0133 | 2,14 | 0,1153 | 0,0107 | 2,14 | 0,1153 | 0,0168 |
| A04- | Fischamend | Flughafen Wien Schwechat | 1,16 | 0,0807 | 0,0041 | 1,16 | 0,0807 | 0,0065 | 1,62 | 0,1129 | 0,0095 | 1,63 | 0,1129 | 0,0149 | 2,39 | 0,1290 | 0,0120 | 2,40 | 0,1290 | 0,0188 |
| A04- | Bruck/Leitha West | Fischamend | 2,54 | 0,1769 | 0,0090 | 2,54 | 0,1769 | 0,0142 | 3,56 | 0,2476 | 0,0208 | 3,57 | 0,2476 | 0,0327 | 5,25 | 0,2830 | 0,0262 | 5,26 | 0,2830 | 0,0412 |
| A04- | Bruck/Leitha Ost | Bruck/Leitha West | 0,84 | 0,0587 | 0,0030 | 0,84 | 0,0587 | 0,0047 | 1,18 | 0,0822 | 0,0069 | 1,19 | 0,0822 | 0,0108 | 1,74 | 0,0940 | 0,0087 | 1,75 | 0,0940 | 0,0137 |
| A04- | KN Bruckneudorf | Bruck/Leitha Ost | 0,53 | 0,0366 | 0,0019 | 0,53 | 0,0366 | 0,0029 | 0,74 | 0,0513 | 0,0043 | 0,74 | 0,0513 | 0,0068 | 1,09 | 0,0586 | 0,0054 | 1,09 | 0,0586 | 0,0085 |
| A04- | Parndorf | KN Bruckneudorf | 0,34 | 0,0236 | 0,0012 | 0,34 | 0,0236 | 0,0019 | 0,48 | 0,0330 | 0,0028 | 0,48 | 0,0330 | 0,0044 | 0,70 | 0,0377 | 0,0035 | 0,70 | 0,0377 | 0,0055 |
| A04- | Neusiedl | Parndorf | 0,65 | 0,0456 | 0,0023 | 0,66 | 0,0456 | 0,0037 | 0,92 | 0,0639 | 0,0054 | 0,92 | 0,0639 | 0,0084 | 1,35 | 0,0730 | 0,0068 | 1,36 | 0,0730 | 0,0106 |
| A04- | Neusiedl/Gewerbepark | Neusiedl | 0,15 | 0,0106 | 0,0005 | 0,15 | 0,0106 | 0,0008 | 0,21 | 0,0148 | 0,0012 | 0,21 | 0,0148 | 0,0020 | 0,31 | 0,0169 | 0,0016 | 0,31 | 0,0169 | 0,0025 |
| A04- | Weiden/Gols | Neusiedl/Gewerbepark | 1,36 | 0,0946 | 0,0048 | 1,36 | 0,0946 | 0,0076 | 1,91 | 0,1325 | 0,0111 | 1,91 | 0,1325 | 0,0175 | 2,81 | 0,1514 | 0,0140 | 2,82 | 0,1514 | 0,0220 |
| A04- | Mönchhof | Weiden/Gols | 0,99 | 0,0690 | 0,0035 | 0,99 | 0,0690 | 0,0055 | 1,39 | 0,0966 | 0,0081 | 1,39 | 0,0966 | 0,0127 | 2,05 | 0,1104 | 0,0102 | 2,05 | 0,1104 | 0,0161 |
| A04- | Nickelsdorf | Mönchhof | 1,55 | 0,1081 | 0,0055 | 1,55 | 0,1081 | 0,0087 | 2,18 | 0,1514 | 0,0127 | 2,18 | 0,1514 | 0,0200 | 3,21 | 0,1730 | 0,0160 | 3,22 | 0,1730 | 0,0252 |
| A04- | Staatsgrenze Nickelsdorf | Nickelsdorf | 0,27 | 0,0192 | 0,0010 | 0,28 | 0,0192 | 0,0015 | 0,39 | 0,0268 | 0,0023 | 0,39 | 0,0268 | 0,0035 | 0,57 | 0,0306 | 0,0028 | 0,57 | 0,0306 | 0,0045 |
| A05- | Wolkersdorf Süd | KN Eibesbrunn | 0,54 | 0,0373 | 0,0019 | 0,54 | 0,0373 | 0,0030 | 0,75 | 0,0522 | 0,0044 | 0,75 | 0,0522 | 0,0069 | 1,11 | 0,0596 | 0,0055 | 1,11 | 0,0596 | 0,0087 |
| A05- | Ulrichskirchen | Wolkersdorf Süd | 0,58 | 0,0403 | 0,0021 | 0,58 | 0,0403 | 0,0032 | 0,81 | 0,0564 | 0,0047 | 0,81 | 0,0564 | 0,0074 | 1,20 | 0,0645 | 0,0060 | 1,20 | 0,0645 | 0,0094 |
| A05- | Wolkersdorf Nord | Ulrichskirchen | 0,38 | 0,0263 | 0,0013 | 0,38 | 0,0263 | 0,0021 | 0,53 | 0,0369 | 0,0031 | 0,53 | 0,0369 | 0,0049 | 0,78 | 0,0422 | 0,0039 | 0,78 | 0,0422 | 0,0061 |
| A05- | Hochleithen | Wolkersdorf Nord | 0,68 | 0,0473 | 0,0024 | 0,68 | 0,0473 | 0,0038 | 0,95 | 0,0662 | 0,0056 | 0,95 | 0,0662 | 0,0087 | 1,40 | 0,0756 | 0,0070 | 1,41 | 0,0756 | 0,0110 |
| A05- | Gaweinstal Mitte | Hochleithen | 1,36 | 0,0946 | 0,0048 | 1,36 | 0,0946 | 0,0076 | 1,90 | 0,1324 | 0,0111 | 1,91 | 0,1324 | 0,0175 | 2,81 | 0,1513 | 0,0140 | 2,81 | 0,1513 | 0,0220 |
| A05- | Gaweinstal Nord | Gaweinstal Mitte | 0,36 | 0,0250 | 0,0013 | 0,36 | 0,0250 | 0,0020 | 0,50 | 0,0350 | 0,0029 | 0,51 | 0,0350 | 0,0046 | 0,74 | 0,0400 | 0,0037 | 0,74 | 0,0400 | 0,0058 |
| A05- | Mistelbach Süd | Gaweinstal Nord | 0,62 | 0,0432 | 0,0022 | 0,62 | 0,0432 | 0,0035 | 0,87 | 0,0605 | 0,0051 | 0,87 | 0,0605 | 0,0080 | 1,28 | 0,0691 | 0,0064 | 1,29 | 0,0691 | 0,0101 |
| A05- | Mistelbach Ost / Wilfersdorf | Mistelbach Süd | 1,04 | 0,0725 | 0,0037 | 1,04 | 0,0725 | 0,0058 | 1,46 | 0,1015 | 0,0085 | 1,46 | 0,1015 | 0,0134 | 2,15 | 0,1160 | 0,0107 | 2,16 | 0,1160 | 0,0169 |
| A05- | Poysdorf Süd | Mistelbach Ost / Wilfersdorf | 1,05 | 0,0732 | 0,0037 | 1,05 | 0,0732 | 0,0059 | 1,47 | 0,1025 | 0,0086 | 1,48 | 0,1025 | 0,0135 | 2,17 | 0,1171 | 0,0108 | 2,18 | 0,1171 | 0,0170 |
| A05- | Großkrut | Poysdorf Süd | 1,39 | 0,0965 | 0,0049 | 1,39 | 0,0965 | 0,0077 | 1,94 | 0,1351 | 0,0113 | 1,95 | 0,1351 | 0,0178 | 2,86 | 0,1544 | 0,0143 | 2,87 | 0,1544 | 0,0225 |
| A05- | Poysdorf Nord | Großkrut | 1,35 | 0,0939 | 0,0048 | 1,35 | 0,0939 | 0,0075 | 1,89 | 0,1314 | 0,0110 | 1,90 | 0,1314 | 0,0173 | 2,79 | 0,1502 | 0,0139 | 2,79 | 0,1502 | 0,0219 |
| A06- | Potzneusiedl | KN Bruckneudorf | 1,71 | 0,1189 | 0,0061 | 1,71 | 0,1189 | 0,0095 | 2,39 | 0,1665 | 0,0140 | 2,40 | 0,1665 | 0,0220 | 3,53 | 0,1903 | 0,0176 | 3,54 | 0,1903 | 0,0277 |
| A06- | Gattendorf | Potzneusiedl | 0,74 | 0,0516 | 0,0026 | 0,74 | 0,0516 | 0,0041 | 1,04 | 0,0723 | 0,0061 | 1,04 | 0,0723 | 0,0095 | 1,53 | 0,0826 | 0,0076 | 1,54 | 0,0826 | 0,0120 |
| A06- | Kittsee | Gattendorf | 1,24 | 0,0863 | 0,0044 | 1,24 | 0,0863 | 0,0069 | 1,74 | 0,1209 | 0,0101 | 1,74 | 0,1209 | 0,0159 | 2,56 | 0,1381 | 0,0128 | 2,57 | 0,1381 | 0,0201 |
| A06- | Staatsgrenze Kittsee | Kittsee | 0,63 | 0,0439 | 0,0022 | 0,63 | 0,0439 | 0,0035 | 0,88 | 0,0614 | 0,0052 | 0,89 | 0,0614 | 0,0081 | 1,30 | 0,0702 | 0,0065 | 1,31 | 0,0702 | 0,0102 |
| A07- | Linz Franzosenhausweg | KN Linz | 0,44 | 0,0309 | 0,0016 | 0,44 | 0,0309 | 0,0025 | 0,62 | 0,0433 | 0,0036 | 0,63 | 0,0433 | 0,0057 | 0,92 | 0,0495 | 0,0046 | 0,92 | 0,0495 | 0,0072 |
| A07- | Linz Salzburger Straße Neue Welt | Linz Franzosenhausweg | 0,39 | 0,0270 | 0,0014 | 0,39 | 0,0270 | 0,0022 | 0,54 | 0,0378 | 0,0032 | 0,55 | 0,0378 | 0,0050 | 0,80 | 0,0432 | 0,0040 | 0,80 | 0,0432 | 0,0063 |
| A07- | Muldenstraße Bindermichl | Linz Salzburger Straße Neue Welt | 0,27 | 0,0187 | 0,0010 | 0,27 | 0,0187 | 0,0015 | 0,38 | 0,0262 | 0,0022 | 0,38 | 0,0262 | 0,0035 | 0,56 | 0,0300 | 0,0028 | 0,56 | 0,0300 | 0,0044 |
| A07- | Leonding Linz Zentrum | Muldenstraße Bindermichl | 0,13 | 0,0091 | 0,0005 | 0,13 | 0,0091 | 0,0007 | 0,18 | 0,0127 | 0,0011 | 0,18 | 0,0127 | 0,0017 | 0,27 | 0,0146 | 0,0013 | 0,27 | 0,0146 | 0,0021 |
| A07- | Linz Wiener Straße | Leonding Linz Zentrum | 0,18 | 0,0128 | 0,0007 | 0,18 | 0,0128 | 0,0010 | 0,26 | 0,0179 | 0,0015 | 0,26 | 0,0179 | 0,0024 | 0,38 | 0,0205 | 0,0019 | 0,38 | 0,0205 | 0,0030 |
| A07- | Linz VOEST | Linz Wiener Straße | 0,17 | 0,0119 | 0,0006 | 0,17 | 0,0119 | 0,0010 | 0,24 | 0,0166 | 0,0014 | 0,24 | 0,0166 | 0,0022 | 0,35 | 0,0190 | 0,0018 | 0,35 | 0,0190 | 0,0028 |
| A07- | Linz Industriezeile | Linz VOEST | 0,13 | 0,0093 | 0,0005 | 0,13 | 0,0093 | 0,0007 | 0,19 | 0,0131 | 0,0011 | 0,19 | 0,0131 | 0,0017 | 0,28 | 0,0149 | 0,0014 | 0,28 | 0,0149 | 0,0022 |
| A07- | Linz Prinz Eugenstraße | Linz Industriezeile | 0,21 | 0,0148 | 0,0008 | 0,21 | 0,0148 | 0,0012 | 0,30 | 0,0207 | 0,0017 | 0,30 | 0,0207 | 0,0027 | 0,44 | 0,0237 | 0,0022 | 0,44 | 0,0237 | 0,0034 |
| A07- | Linz Hafensstraße | Linz Prinz Eugenstraße | 0,40 | 0,0277 | 0,0014 | 0,40 | 0,0277 | 0,0022 | 0,56 | 0,0388 | 0,0033 | 0,56 | 0,0388 | 0,0051 | 0,82 | 0,0443 | 0,0041 | 0,82 | 0,0443 | 0,0065 |
| A07- | Linz Urfahr | Linz Hafensstraße | 0,16 | 0,0109 | 0,0006 | 0,16 | 0,0109 | 0,0009 | 0,22 | 0,0152 | 0,0013 | 0,22 | 0,0152 | 0,0020 | 0,32 | 0,0174 | 0,0016 | 0,32 | 0,0174 | 0,0025 |
| A07- | Linz Dornach | Linz Urfahr | 0,38 | 0,0264 | 0,0013 | 0,38 | 0,0264 | | | | | | | | | | | | | |

| | | | | | | | | | | | | | | | | | | | | |
|------|---|--------------------------------------|-------|--------|--------|-------|--------|--------|-------|--------|--------|-------|--------|--------|-------|--------|--------|-------|--------|--------|
| A08- | Staatsgrenze Suben | Schärding Suben | 0,44 | 0,0306 | 0,0016 | 0,44 | 0,0306 | 0,0025 | 0,62 | 0,0428 | 0,0036 | 0,62 | 0,0428 | 0,0056 | 0,91 | 0,0489 | 0,0045 | 0,91 | 0,0489 | 0,0071 |
| A09- | Ried im Traunkreis | KN Voralpenkreuz | 1,08 | 0,0754 | 0,0039 | 1,08 | 0,0754 | 0,0061 | 1,52 | 0,1055 | 0,0089 | 1,52 | 0,1055 | 0,0139 | 2,24 | 0,1206 | 0,0112 | 2,24 | 0,1206 | 0,0175 |
| A09- | Inzersdorf Kirchdorf | Ried im Traunkreis | 2,03 | 0,1414 | 0,0072 | 2,03 | 0,1414 | 0,0114 | 2,85 | 0,1979 | 0,0166 | 2,86 | 0,1979 | 0,0261 | 4,20 | 0,2262 | 0,0209 | 4,21 | 0,2262 | 0,0329 |
| A09- | Klaus | Inzersdorf Kirchdorf | 2,47 | 0,1722 | 0,0088 | 2,48 | 0,1722 | 0,0138 | 3,47 | 0,2411 | 0,0202 | 3,48 | 0,2411 | 0,0318 | 5,11 | 0,2755 | 0,0255 | 5,13 | 0,2755 | 0,0401 |
| A09- | St. Pankratz | Klaus | 1,57 | 0,1095 | 0,0056 | 1,57 | 0,1095 | 0,0088 | 2,20 | 0,1532 | 0,0129 | 2,21 | 0,1532 | 0,0202 | 3,25 | 0,1751 | 0,0162 | 3,26 | 0,1751 | 0,0255 |
| A09- | Roßleiten Windischgarsten | St. Pankratz | 2,19 | 0,1527 | 0,0078 | 2,20 | 0,1527 | 0,0123 | 3,08 | 0,2138 | 0,0179 | 3,09 | 0,2138 | 0,0282 | 4,53 | 0,2444 | 0,0226 | 4,55 | 0,2444 | 0,0356 |
| A09- | Gleinkerau | Roßleiten Windischgarsten | 1,03 | 0,0718 | 0,0037 | 1,03 | 0,0718 | 0,0058 | 1,45 | 0,1005 | 0,0084 | 1,45 | 0,1005 | 0,0133 | 2,13 | 0,1149 | 0,0106 | 2,14 | 0,1149 | 0,0167 |
| A09- | Spital am Pyhrn | Gleinkerau | 0,78 | 0,0541 | 0,0028 | 0,78 | 0,0541 | 0,0043 | 1,09 | 0,0758 | 0,0064 | 1,09 | 0,0758 | 0,0100 | 1,61 | 0,0866 | 0,0080 | 1,61 | 0,0866 | 0,0126 |
| A09- | Ardning / Admont | Spital am Pyhrn | 4,27 | 0,1378 | 0,0070 | 4,27 | 0,1378 | 0,0111 | 5,98 | 0,1929 | 0,0162 | 5,99 | 0,1929 | 0,0254 | 8,90 | 0,2204 | 0,0204 | 8,91 | 0,2204 | 0,0321 |
| A09- | Liezen | Ardning / Admont | 0,45 | 0,0314 | 0,0016 | 0,45 | 0,0314 | 0,0025 | 0,63 | 0,0440 | 0,0037 | 0,63 | 0,0440 | 0,0058 | 0,93 | 0,0502 | 0,0047 | 0,93 | 0,0502 | 0,0073 |
| A09- | Rottenmann | Liezen | 0,94 | 0,0656 | 0,0034 | 0,94 | 0,0656 | 0,0053 | 1,32 | 0,0919 | 0,0077 | 1,33 | 0,0919 | 0,0121 | 1,95 | 0,1050 | 0,0097 | 1,95 | 0,1050 | 0,0153 |
| A09- | Trieben | Rottenmann | 2,35 | 0,1636 | 0,0084 | 2,35 | 0,1636 | 0,0131 | 3,29 | 0,2290 | 0,0192 | 3,30 | 0,2290 | 0,0302 | 4,85 | 0,2617 | 0,0242 | 4,87 | 0,2617 | 0,0381 |
| A09- | Treglwang | Trieben | 1,91 | 0,1330 | 0,0068 | 1,91 | 0,1330 | 0,0107 | 2,68 | 0,1862 | 0,0156 | 2,69 | 0,1862 | 0,0246 | 3,95 | 0,2128 | 0,0197 | 3,96 | 0,2128 | 0,0310 |
| A09- | Kalwang | Treglwang | 2,56 | 0,1787 | 0,0091 | 2,57 | 0,1787 | 0,0143 | 3,60 | 0,2502 | 0,0210 | 3,61 | 0,2502 | 0,0330 | 5,30 | 0,2859 | 0,0265 | 5,32 | 0,2859 | 0,0416 |
| A09- | Mautern | Kalwang | 1,19 | 0,0832 | 0,0043 | 1,20 | 0,0832 | 0,0067 | 1,68 | 0,1165 | 0,0098 | 1,68 | 0,1165 | 0,0154 | 2,47 | 0,1331 | 0,0123 | 2,48 | 0,1331 | 0,0194 |
| A09- | Kammern | Mautern | 1,34 | 0,0936 | 0,0048 | 1,35 | 0,0936 | 0,0075 | 1,89 | 0,1311 | 0,0110 | 1,89 | 0,1311 | 0,0173 | 2,78 | 0,1498 | 0,0139 | 2,79 | 0,1498 | 0,0218 |
| A09- | Traboch | Kammern | 1,40 | 0,0979 | 0,0050 | 1,41 | 0,0979 | 0,0079 | 1,97 | 0,1370 | 0,0115 | 1,98 | 0,1370 | 0,0181 | 2,90 | 0,1566 | 0,0145 | 2,91 | 0,1566 | 0,0228 |
| A09- | Terminal St. Michael | Traboch | 0,28 | 0,0192 | 0,0010 | 0,28 | 0,0192 | 0,0015 | 0,39 | 0,0269 | 0,0023 | 0,39 | 0,0269 | 0,0035 | 0,57 | 0,0308 | 0,0028 | 0,57 | 0,0308 | 0,0045 |
| A09- | KN St. Michael | Terminal St. Michael | 0,52 | 0,0360 | 0,0018 | 0,52 | 0,0360 | 0,0029 | 0,73 | 0,0504 | 0,0042 | 0,73 | 0,0504 | 0,0067 | 1,07 | 0,0576 | 0,0053 | 1,07 | 0,0576 | 0,0084 |
| A09- | Übelbach | KN St. Michael | 10,40 | 0,3356 | 0,0171 | 10,41 | 0,3356 | 0,0269 | 14,58 | 0,4698 | 0,0394 | 14,60 | 0,4698 | 0,0620 | 21,69 | 0,5369 | 0,0497 | 21,71 | 0,5369 | 0,0781 |
| A09- | KN Peggau Deutschefstritz | Übelbach | 1,59 | 0,1110 | 0,0057 | 1,60 | 0,1110 | 0,0089 | 2,23 | 0,1554 | 0,0130 | 2,24 | 0,1554 | 0,0205 | 3,29 | 0,1776 | 0,0164 | 3,30 | 0,1776 | 0,0258 |
| A09- | Gratkorn Nord | KN Peggau Deutschefstritz | 0,75 | 0,0526 | 0,0027 | 0,76 | 0,0526 | 0,0042 | 1,06 | 0,0736 | 0,0062 | 1,06 | 0,0736 | 0,0097 | 1,56 | 0,0841 | 0,0078 | 1,56 | 0,0841 | 0,0122 |
| A09- | Gratkorn Süd | Gratkorn Nord | 0,83 | 0,0577 | 0,0030 | 0,83 | 0,0577 | 0,0046 | 1,16 | 0,0808 | 0,0068 | 1,17 | 0,0808 | 0,0107 | 1,71 | 0,0924 | 0,0086 | 1,72 | 0,0924 | 0,0134 |
| A09- | Graz Nord | Gratkorn Süd | 0,18 | 0,0128 | 0,0007 | 0,18 | 0,0128 | 0,0010 | 0,26 | 0,0179 | 0,0015 | 0,26 | 0,0179 | 0,0024 | 0,38 | 0,0205 | 0,0019 | 0,38 | 0,0205 | 0,0030 |
| A09- | Graz Webling | Graz Nord | 2,10 | 0,1464 | 0,0075 | 2,10 | 0,1464 | 0,0118 | 2,95 | 0,2049 | 0,0172 | 2,96 | 0,2049 | 0,0270 | 4,34 | 0,2342 | 0,0217 | 4,36 | 0,2342 | 0,0341 |
| A09- | Seiersberg | Graz Webling | 0,56 | 0,0389 | 0,0020 | 0,56 | 0,0389 | 0,0031 | 0,78 | 0,0545 | 0,0046 | 0,79 | 0,0545 | 0,0072 | 1,15 | 0,0623 | 0,0058 | 1,16 | 0,0623 | 0,0091 |
| A09- | KN Graz West | Seiersberg | 0,27 | 0,0190 | 0,0010 | 0,27 | 0,0190 | 0,0015 | 0,38 | 0,0267 | 0,0022 | 0,38 | 0,0267 | 0,0035 | 0,57 | 0,0305 | 0,0028 | 0,57 | 0,0305 | 0,0044 |
| A09- | Schwarzlsee | KN Graz West | 0,27 | 0,0188 | 0,0010 | 0,27 | 0,0188 | 0,0015 | 0,38 | 0,0263 | 0,0022 | 0,38 | 0,0263 | 0,0035 | 0,56 | 0,0300 | 0,0028 | 0,56 | 0,0300 | 0,0044 |
| A09- | Schachenwald / IBC Businesscenter | Schwarzlsee | 0,30 | 0,0210 | 0,0011 | 0,30 | 0,0210 | 0,0017 | 0,42 | 0,0294 | 0,0025 | 0,42 | 0,0294 | 0,0039 | 0,62 | 0,0336 | 0,0031 | 0,62 | 0,0336 | 0,0049 |
| A09- | Kalsdorf | Schachenwald / IBC Businesscenter | 0,31 | 0,0213 | 0,0011 | 0,31 | 0,0213 | 0,0017 | 0,43 | 0,0299 | 0,0025 | 0,43 | 0,0299 | 0,0039 | 0,63 | 0,0342 | 0,0032 | 0,64 | 0,0342 | 0,0050 |
| A09- | Werndorf Terminal | Kalsdorf | 0,77 | 0,0534 | 0,0027 | 0,77 | 0,0534 | 0,0043 | 1,08 | 0,0748 | 0,0063 | 1,08 | 0,0748 | 0,0099 | 1,59 | 0,0855 | 0,0079 | 1,59 | 0,0855 | 0,0124 |
| A09- | Wildon | Werndorf Terminal | 0,86 | 0,0597 | 0,0031 | 0,86 | 0,0597 | 0,0048 | 1,20 | 0,0836 | 0,0070 | 1,21 | 0,0836 | 0,0110 | 1,77 | 0,0955 | 0,0088 | 1,78 | 0,0955 | 0,0139 |
| A09- | Hengsberg | Wildon | 0,42 | 0,0292 | 0,0015 | 0,42 | 0,0292 | 0,0023 | 0,59 | 0,0408 | 0,0034 | 0,59 | 0,0408 | 0,0054 | 0,87 | 0,0466 | 0,0043 | 0,87 | 0,0466 | 0,0068 |
| A09- | Lebring | Hengsberg | 0,74 | 0,0516 | 0,0026 | 0,74 | 0,0516 | 0,0041 | 1,04 | 0,0723 | 0,0061 | 1,04 | 0,0723 | 0,0095 | 1,53 | 0,0826 | 0,0077 | 1,54 | 0,0826 | 0,0120 |
| A09- | Leibnitz | Lebring | 1,28 | 0,0894 | 0,0046 | 1,29 | 0,0894 | 0,0072 | 1,80 | 0,1252 | 0,0105 | 1,81 | 0,1252 | 0,0165 | 2,65 | 0,1430 | 0,0132 | 2,66 | 0,1430 | 0,0208 |
| A09- | Vogau Straß | Leibnitz | 1,57 | 0,1093 | 0,0056 | 1,57 | 0,1093 | 0,0088 | 2,20 | 0,1531 | 0,0128 | 2,21 | 0,1531 | 0,0202 | 3,24 | 0,1749 | 0,0162 | 3,25 | 0,1749 | 0,0255 |
| A09- | Gersdorf | Vogau Straß | 0,76 | 0,0530 | 0,0027 | 0,76 | 0,0530 | 0,0043 | 1,07 | 0,0742 | 0,0062 | 1,07 | 0,0742 | 0,0098 | 1,57 | 0,0849 | 0,0079 | 1,58 | 0,0849 | 0,0123 |
| A09- | Spielfeld | Gersdorf | 0,40 | 0,0279 | 0,0014 | 0,40 | 0,0279 | 0,0022 | 0,56 | 0,0391 | 0,0033 | 0,56 | 0,0391 | 0,0052 | 0,83 | 0,0447 | 0,0041 | 0,83 | 0,0447 | 0,0065 |
| A09- | Staatsgrenze Spielfeld | Spielfeld | 0,37 | 0,0255 | 0,0013 | 0,37 | 0,0255 | 0,0020 | 0,51 | 0,0357 | 0,0030 | 0,51 | 0,0357 | 0,0047 | 0,76 | 0,0408 | 0,0038 | 0,76 | 0,0408 | 0,0059 |
| A10- | Salzburg Süd / Anif | KN Salzburg | 1,48 | 0,1031 | 0,0053 | 1,48 | 0,1031 | 0,0083 | 2,08 | 0,1443 | 0,0121 | 2,08 | 0,1443 | 0,0190 | 3,06 | 0,1649 | 0,0153 | 3,07 | 0,1649 | 0,0240 |
| A10- | Puch Urstein | Salzburg Süd / Anif | 0,50 | 0,0350 | 0,0018 | 0,50 | 0,0350 | 0,0028 | 0,70 | 0,0490 | 0,0041 | 0,71 | 0,0490 | 0,0065 | 1,04 | 0,0560 | 0,0052 | 1,04 | 0,0560 | 0,0081 |
| A10- | Hallein | Puch Urstein | 1,04 | 0,0722 | 0,0037 | 1,04 | 0,0722 | 0,0058 | 1,45 | 0,1011 | 0,0085 | 1,46 | 0,1011 | 0,0133 | 2,14 | 0,1155 | 0,0107 | 2,15 | 0,1155 | 0,0168 |
| A10- | Kuchl | Hallein | 1,15 | 0,0802 | 0,0041 | 1,15 | 0,0802 | 0,0064 | 1,61 | 0,1123 | 0,0094 | 1,62 | 0,1123 | 0,0148 | 2,38 | 0,1283 | 0,0119 | 2,39 | 0,1283 | 0,0187 |
| A10- | Golling / Abtenau | Kuchl | 1,16 | 0,0806 | 0,0041 | 1,16 | 0,0806 | 0,0065 | 1,62 | 0,1129 | 0,0095 | 1,63 | 0,1129 | 0,0149 | 2,39 | 0,1290 | 0,0119 | 2,40 | 0,1290 | 0,0188 |
| A10- | Paß Lueg | Golling / Abtenau | 1,21 | 0,0841 | 0,0043 | 1,21 | 0,0841 | 0,0068 | 1,69 | 0,1178 | 0,0099 | 1,70 | 0,1178 | 0,0155 | 2,50 | 0,1346 | 0,0125 | 2,50 | 0,1346 | 0,0196 |
| A10- | Werfen | Paß Lueg | 1,72 | 0,1198 | 0,0061 | 1,72 | 0,1198 | 0,0096 | 2,41 | 0,1678 | 0,0141 | 2,42 | 0,1678 | 0,0221 | 3,56 | 0,1917 | 0,0178 | 3,57 | 0,1917 | 0,0279 |
| A10- | Pfarrwerfen / Werfen | Werfen | 0,22 | 0,0156 | 0,0008 | 0,22 | 0,0156 | 0,0013 | 0,31 | 0,0219 | 0,0018 | 0,32 | 0,0219 | 0,0029 | 0,46 | 0,0250 | 0,0023 | 0,46 | 0,0250 | 0,0036 |
| A10- | KN Pongau | Pfarrwerfen / Werfen | 0,49 | 0,0339 | 0,0017 | 0,49 | 0,0339 | 0,0027 | 0,68 | 0,0475 | 0,0040 | 0,68 | 0,0475 | 0,0063 | 1,01 | 0,0542 | 0,0050 | 1,01 | 0,0542 | 0,0079 |
| A101 | Bischofshofen Mühlbach a. Hochkönig | KN Pongau | 0,72 | 0,0504 | 0,0026 | 0,72 | 0,0504 | 0,0040 | 1,02 | 0,0706 | 0,0059 | 1,02 | 0,0706 | 0,0093 | 1,50 | 0,0807 | 0,0075 | 1,50 | 0,0807 | 0,0117 |
| A10- | Lammertal Hüttal | KN Pongau | 1,98 | 0,1379 | 0,0070 | 1,98 | 0,1379 | 0,0111 | 2,78 | 0,1930 | 0,0162 | 2,79 | 0,1930 | 0,0255 | 4,09 | 0,2206 | 0,0204 | 4,10 | 0,2206 | 0,0321 |
| A10- | F. Verbindung GH Eben | Lammertal Hüttal | 0,51 | 0,0355 | 0,0018 | 0,51 | 0,0355 | 0,0028 | 0,71 | 0,0497 | 0,0042 | 0,72 | 0,0497 | 0,0066 | 1,05 | 0,0568 | 0,0053 | 1,06 | 0,0568 | 0,0083 |

| | | | | | | | | | | | | | | | | | | | | |
|------|-------------------------------------|-------------------------------------|------|--------|--------|------|--------|--------|------|--------|--------|------|--------|--------|-------|--------|--------|-------|--------|--------|
| A12- | Kufstein Nord | Staatsgrenze Kufstein | 0,36 | 0,0000 | 0,0000 | 0,36 | 0,0000 | 0,0000 | 0,51 | 0,0000 | 0,0000 | 0,51 | 0,0000 | 0,0000 | 0,76 | 0,0000 | 0,0000 | 0,76 | 0,0000 | 0,0000 |
| A12- | Kufstein Süd | Kufstein Nord | 0,93 | 0,0000 | 0,0000 | 0,93 | 0,0000 | 0,0000 | 1,31 | 0,0000 | 0,0000 | 1,31 | 0,0000 | 0,0000 | 1,96 | 0,0000 | 0,0000 | 1,96 | 0,0000 | 0,0000 |
| A12- | Kirchbichl Langkampfen | Kufstein Süd | 1,27 | 0,0000 | 0,0000 | 1,27 | 0,0000 | 0,0000 | 1,78 | 0,0000 | 0,0000 | 1,78 | 0,0000 | 0,0000 | 2,68 | 0,0000 | 0,0000 | 2,68 | 0,0000 | 0,0000 |
| A12- | Wörgl Ost St.Johann i. T. Brixental | Kirchbichl Langkampfen | 1,25 | 0,0000 | 0,0000 | 1,25 | 0,0000 | 0,0000 | 1,75 | 0,0000 | 0,0000 | 1,75 | 0,0000 | 0,0000 | 2,62 | 0,0000 | 0,0000 | 2,62 | 0,0000 | 0,0000 |
| A12- | Wörgl West | Wörgl Ost St.Johann i. T. Brixental | 0,66 | 0,0000 | 0,0000 | 0,66 | 0,0000 | 0,0000 | 0,92 | 0,0000 | 0,0000 | 0,92 | 0,0000 | 0,0000 | 1,38 | 0,0000 | 0,0000 | 1,38 | 0,0000 | 0,0000 |
| A12- | Kramsach Rattenberg Brixlegg | Wörgl West | 2,80 | 0,0000 | 0,0000 | 2,80 | 0,0000 | 0,0000 | 3,92 | 0,0000 | 0,0000 | 3,92 | 0,0000 | 0,0000 | 5,88 | 0,0000 | 0,0000 | 5,88 | 0,0000 | 0,0000 |
| A12- | Wiesing Achensee Zillertal | Kramsach Rattenberg Brixlegg | 1,72 | 0,0000 | 0,0000 | 1,72 | 0,0000 | 0,0000 | 2,40 | 0,0000 | 0,0000 | 2,40 | 0,0000 | 0,0000 | 3,61 | 0,0000 | 0,0000 | 3,61 | 0,0000 | 0,0000 |
| A12- | Jenbach | Wiesing Achensee Zillertal | 0,68 | 0,0000 | 0,0000 | 0,68 | 0,0000 | 0,0000 | 0,95 | 0,0000 | 0,0000 | 0,95 | 0,0000 | 0,0000 | 1,43 | 0,0000 | 0,0000 | 1,43 | 0,0000 | 0,0000 |
| A12- | Schwaz | Jenbach | 1,50 | 0,0000 | 0,0000 | 1,50 | 0,0000 | 0,0000 | 2,10 | 0,0000 | 0,0000 | 2,10 | 0,0000 | 0,0000 | 3,15 | 0,0000 | 0,0000 | 3,15 | 0,0000 | 0,0000 |
| A12- | Vomp | Schwaz | 0,86 | 0,0000 | 0,0000 | 0,86 | 0,0000 | 0,0000 | 1,20 | 0,0000 | 0,0000 | 1,20 | 0,0000 | 0,0000 | 1,80 | 0,0000 | 0,0000 | 1,80 | 0,0000 | 0,0000 |
| A12- | Wattens | Vomp | 1,77 | 0,0000 | 0,0000 | 1,77 | 0,0000 | 0,0000 | 2,47 | 0,0000 | 0,0000 | 2,47 | 0,0000 | 0,0000 | 3,71 | 0,0000 | 0,0000 | 3,71 | 0,0000 | 0,0000 |
| A12- | Hall/Tirol Mitte | Wattens | 1,57 | 0,0000 | 0,0000 | 1,57 | 0,0000 | 0,0000 | 2,19 | 0,0000 | 0,0000 | 2,19 | 0,0000 | 0,0000 | 3,29 | 0,0000 | 0,0000 | 3,29 | 0,0000 | 0,0000 |
| A12- | Hall/Tirol West | Hall/Tirol Mitte | 0,63 | 0,0000 | 0,0000 | 0,63 | 0,0000 | 0,0000 | 0,88 | 0,0000 | 0,0000 | 0,88 | 0,0000 | 0,0000 | 1,32 | 0,0000 | 0,0000 | 1,32 | 0,0000 | 0,0000 |
| A12- | A12 Innsbruck Ost | Hall/Tirol West | 0,70 | 0,0000 | 0,0000 | 0,70 | 0,0000 | 0,0000 | 0,97 | 0,0000 | 0,0000 | 0,97 | 0,0000 | 0,0000 | 1,46 | 0,0000 | 0,0000 | 1,46 | 0,0000 | 0,0000 |
| A12- | Innsbruck Mitte | A12 Innsbruck Ost | 0,46 | 0,0078 | 0,0004 | 0,46 | 0,0078 | 0,0006 | 0,65 | 0,0109 | 0,0009 | 0,65 | 0,0109 | 0,0014 | 0,97 | 0,0124 | 0,0011 | 0,97 | 0,0124 | 0,0018 |
| A12- | A12 Innsbruck West | Innsbruck Mitte | 0,63 | 0,0438 | 0,0022 | 0,63 | 0,0438 | 0,0035 | 0,88 | 0,0614 | 0,0052 | 0,89 | 0,0614 | 0,0081 | 1,30 | 0,0701 | 0,0065 | 1,30 | 0,0701 | 0,0102 |
| A12- | Innsbruck Kranebitten | A12 Innsbruck West | 0,82 | 0,0575 | 0,0029 | 0,83 | 0,0575 | 0,0046 | 1,16 | 0,0804 | 0,0068 | 1,16 | 0,0804 | 0,0106 | 1,71 | 0,0919 | 0,0085 | 1,71 | 0,0919 | 0,0134 |
| A12- | Zirl Ost Garmisch Seefeld | Innsbruck Kranebitten | 0,96 | 0,0667 | 0,0034 | 0,96 | 0,0667 | 0,0054 | 1,34 | 0,0933 | 0,0078 | 1,35 | 0,0933 | 0,0123 | 1,98 | 0,1067 | 0,0099 | 1,98 | 0,1067 | 0,0155 |
| A12- | Zirl West | Zirl Ost Garmisch Seefeld | 0,60 | 0,0417 | 0,0021 | 0,60 | 0,0417 | 0,0033 | 0,84 | 0,0584 | 0,0049 | 0,84 | 0,0584 | 0,0077 | 1,24 | 0,0667 | 0,0062 | 1,24 | 0,0667 | 0,0097 |
| A12- | Petttau | Zirl West | 1,07 | 0,0747 | 0,0038 | 1,07 | 0,0747 | 0,0060 | 1,50 | 0,1046 | 0,0088 | 1,51 | 0,1046 | 0,0138 | 2,22 | 0,1195 | 0,0111 | 2,22 | 0,1195 | 0,0174 |
| A12- | Telfs Ost | Petttau | 1,08 | 0,0755 | 0,0039 | 1,09 | 0,0755 | 0,0061 | 1,52 | 0,1057 | 0,0089 | 1,53 | 0,1057 | 0,0139 | 2,24 | 0,1208 | 0,0112 | 2,25 | 0,1208 | 0,0176 |
| A12- | Telfs West | Telfs Ost | 0,53 | 0,0369 | 0,0019 | 0,53 | 0,0369 | 0,0030 | 0,74 | 0,0516 | 0,0043 | 0,75 | 0,0516 | 0,0068 | 1,09 | 0,0590 | 0,0055 | 1,10 | 0,0590 | 0,0086 |
| A12- | Mötz Reutte | Telfs West | 1,71 | 0,1192 | 0,0061 | 1,71 | 0,1192 | 0,0096 | 2,40 | 0,1669 | 0,0140 | 2,41 | 0,1669 | 0,0220 | 3,54 | 0,1907 | 0,0177 | 3,55 | 0,1907 | 0,0278 |
| A12- | Haiming Ötztal | Mötz Reutte | 1,99 | 0,1386 | 0,0071 | 1,99 | 0,1386 | 0,0111 | 2,79 | 0,1941 | 0,0163 | 2,80 | 0,1941 | 0,0256 | 4,11 | 0,2218 | 0,0205 | 4,13 | 0,2218 | 0,0323 |
| A12- | Imst | Haiming Ötztal | 1,58 | 0,1104 | 0,0056 | 1,59 | 0,1104 | 0,0089 | 2,22 | 0,1545 | 0,0130 | 2,23 | 0,1545 | 0,0204 | 3,28 | 0,1766 | 0,0164 | 3,28 | 0,1766 | 0,0257 |
| A12- | Imst Au | Imst | 0,47 | 0,0326 | 0,0017 | 0,47 | 0,0326 | 0,0026 | 0,66 | 0,0456 | 0,0038 | 0,66 | 0,0456 | 0,0060 | 0,97 | 0,0521 | 0,0048 | 0,97 | 0,0521 | 0,0076 |
| A12- | Mils | Imst Au | 0,38 | 0,0263 | 0,0013 | 0,38 | 0,0263 | 0,0021 | 0,53 | 0,0368 | 0,0031 | 0,53 | 0,0368 | 0,0049 | 0,78 | 0,0420 | 0,0039 | 0,78 | 0,0420 | 0,0061 |
| A12- | Mils Schönwies | Mils | 0,93 | 0,0647 | 0,0033 | 0,93 | 0,0647 | 0,0052 | 1,30 | 0,0905 | 0,0076 | 1,31 | 0,0905 | 0,0119 | 1,92 | 0,1035 | 0,0096 | 1,92 | 0,1035 | 0,0151 |
| A12- | KN Oberinntal | Mils Schönwies | 0,82 | 0,0573 | 0,0029 | 0,82 | 0,0573 | 0,0046 | 1,15 | 0,0802 | 0,0067 | 1,16 | 0,0802 | 0,0106 | 1,70 | 0,0916 | 0,0085 | 1,70 | 0,0916 | 0,0133 |
| A12- | Zams | KN Oberinntal | 0,22 | 0,0151 | 0,0008 | 0,22 | 0,0151 | 0,0012 | 0,30 | 0,0211 | 0,0018 | 0,30 | 0,0211 | 0,0028 | 0,45 | 0,0241 | 0,0022 | 0,45 | 0,0241 | 0,0035 |
| A122 | Fließ | KN Oberinntal | 1,54 | 0,1071 | 0,0055 | 1,54 | 0,1071 | 0,0086 | 2,16 | 0,1500 | 0,0126 | 2,16 | 0,1500 | 0,0198 | 3,18 | 0,1714 | 0,0159 | 3,19 | 0,1714 | 0,0249 |
| A13- | A13 Innsbruck Süd | A12 Innsbruck Ost | 2,20 | 0,0000 | 0,0000 | 2,20 | 0,0000 | 0,0000 | 3,08 | 0,0000 | 0,0000 | 3,08 | 0,0000 | 0,0000 | 4,62 | 0,0000 | 0,0000 | 8,50 | 0,0000 | 0,0000 |
| A13- | Zenzenhof | A13 Innsbruck Süd | 0,88 | 0,0000 | 0,0000 | 0,88 | 0,0000 | 0,0000 | 1,23 | 0,0000 | 0,0000 | 1,23 | 0,0000 | 0,0000 | 1,84 | 0,0000 | 0,0000 | 3,68 | 0,0000 | 0,0000 |
| A13- | Igls Patsch | Zenzenhof | 1,62 | 0,0000 | 0,0000 | 1,62 | 0,0000 | 0,0000 | 2,27 | 0,0000 | 0,0000 | 2,27 | 0,0000 | 0,0000 | 3,41 | 0,0000 | 0,0000 | 6,82 | 0,0000 | 0,0000 |
| A13- | Schönberg Stubaital | Igls Patsch | 1,76 | 0,0000 | 0,0000 | 1,76 | 0,0000 | 0,0000 | 2,46 | 0,0000 | 0,0000 | 2,46 | 0,0000 | 0,0000 | 3,69 | 0,0000 | 0,0000 | 7,38 | 0,0000 | 0,0000 |
| A13- | Matrei Steinach | Schönberg Stubaital | 5,54 | 0,0000 | 0,0000 | 5,54 | 0,0000 | 0,0000 | 7,76 | 0,0000 | 0,0000 | 7,76 | 0,0000 | 0,0000 | 11,63 | 0,0000 | 0,0000 | 23,26 | 0,0000 | 0,0000 |
| A13- | Nösslach | Matrei Steinach | 4,46 | 0,0000 | 0,0000 | 4,46 | 0,0000 | 0,0000 | 6,24 | 0,0000 | 0,0000 | 6,24 | 0,0000 | 0,0000 | 9,36 | 0,0000 | 0,0000 | 18,72 | 0,0000 | 0,0000 |
| A13- | Brenner-Nord | Nösslach | 4,00 | 0,0000 | 0,0000 | 4,00 | 0,0000 | 0,0000 | 5,60 | 0,0000 | 0,0000 | 5,60 | 0,0000 | 0,0000 | 8,40 | 0,0000 | 0,0000 | 16,80 | 0,0000 | 0,0000 |
| A13- | Staatsgrenze Brennerpass | Brenner-Nord | 0,79 | 0,0000 | 0,0000 | 0,79 | 0,0000 | 0,0000 | 1,11 | 0,0000 | 0,0000 | 1,11 | 0,0000 | 0,0000 | 1,66 | 0,0000 | 0,0000 | 3,32 | 0,0000 | 0,0000 |
| A131 | A13 Innsbruck Süd | A12 Innsbruck West | 1,40 | 0,0143 | 0,0007 | 1,41 | 0,0143 | 0,0011 | 1,97 | 0,0200 | 0,0017 | 1,97 | 0,0200 | 0,0026 | 2,94 | 0,0228 | 0,0021 | 5,46 | 0,0228 | 0,0033 |
| A14- | Hörbranz Lochau | Staatsgrenze Hörbranz | 0,25 | 0,0173 | 0,0009 | 0,25 | 0,0173 | 0,0014 | 0,35 | 0,0242 | 0,0020 | 0,35 | 0,0242 | 0,0032 | 0,51 | 0,0276 | 0,0026 | 0,51 | 0,0276 | 0,0040 |
| A14- | KN Bregenz | Hörbranz Lochau | 1,52 | 0,1062 | 0,0054 | 1,53 | 0,1062 | 0,0085 | 2,14 | 0,1486 | 0,0125 | 2,14 | 0,1486 | 0,0196 | 3,15 | 0,1699 | 0,0157 | 3,16 | 0,1699 | 0,0247 |
| A14- | Lauterach Wolfurt | KN Bregenz | 0,08 | 0,0053 | 0,0003 | 0,08 | 0,0053 | 0,0004 | 0,11 | 0,0075 | 0,0006 | 0,11 | 0,0075 | 0,0010 | 0,16 | 0,0085 | 0,0008 | 0,16 | 0,0085 | 0,0012 |
| A14- | Wolfurt Lauterach | Lauterach Wolfurt | 0,68 | 0,0472 | 0,0024 | 0,68 | 0,0472 | 0,0038 | 0,95 | 0,0661 | 0,0056 | 0,95 | 0,0661 | 0,0087 | 1,40 | 0,0756 | 0,0070 | 1,41 | 0,0756 | 0,0110 |
| A14- | Dornbirn Nord Bregenzerwald | Wolfurt Lauterach | 0,26 | 0,0183 | 0,0009 | 0,26 | 0,0183 | 0,0015 | 0,37 | 0,0256 | 0,0021 | 0,37 | 0,0256 | 0,0034 | 0,54 | 0,0292 | 0,0027 | 0,54 | 0,0292 | 0,0043 |
| A14- | Dornbirn Süd Lustenau | Dornbirn Nord Bregenzerwald | 0,73 | 0,0511 | 0,0026 | 0,73 | 0,0511 | 0,0041 | 1,03 | 0,0715 | 0,0060 | 1,03 | 0,0715 | 0,0094 | 1,52 | 0,0817 | 0,0076 | 1,52 | 0,0817 | 0,0119 |
| A14- | Hohenems | Dornbirn Süd Lustenau | 1,03 | 0,0718 | 0,0037 | 1,03 | 0,0718 | 0,0058 | 1,45 | 0,1006 | 0,0084 | 1,45 | 0,1006 | 0,0133 | 2,13 | 0,1149 | 0,0106 | 2,14 | 0,1149 | 0,0167 |
| A14- | Altach Götzis | Hohenems | 0,67 | 0,0468 | 0,0024 | 0,67 | 0,0468 | 0,0038 | 0,94 | 0,0656 | 0,0055 | 0,95 | 0,0656 | 0,0087 | 1,39 | 0,0749 | 0,0069 | 1,39 | 0,0749 | 0,0109 |
| A14- | Götzis | Altach Götzis | 0,51 | 0,0357 | 0,0018 | 0,51 | 0,0357 | 0,0029 | 0,72 | 0,0500 | 0,0042 | 0,72 | 0,0500 | 0,0066 | 1,06 | 0,0571 | 0,0053 | 1,06 | 0,0571 | 0,0083 |
| A14- | Klaus Koblach | Götzis | 0,45 | 0,0310 | 0,0016 | 0,45 | 0,0310 | 0,0025 | 0,62 | 0,0434 | 0,0036 | 0,63 | 0,0434 | 0,0057 | 0,92 | 0,0496 | 0,0046 | 0,92 | 0,0496 | 0,0072 |
| A14- | Rankweil | Klaus Koblach | 0,78 | 0,0545 | 0,0028 | 0,78 | 0,0545 | 0,0044 | 1,10 | 0,0763 | 0,0064 | 1,10 | 0,0763 | 0,0101 | 1,62 | 0,0872 | 0,0081 | 1,62 | 0,0872 | 0,0127 |
| A14- | Feldkirch Frastanz | Rankweil | 1,11 | 0,0777 | 0,0040 | 1,12 | 0,0777 | 0,0062 | 1,56 | 0,1087 | 0,0091 | 1,57 | 0,1087 | 0,0143 | 2,30 | 0,1242 | 0,0115 | 2,31 | 0,1242 | 0,0181 |
| A14- | Nenzing Bludesch | Feldkirch Frastanz | 1,76 | 0,1228 | 0,0063 | 1,77 | 0,1228 | 0,0099 | 2,47 | 0,1719 | 0,0144 | 2,48 | 0,1719 | 0,0227 | 3,64 | 0,1965 | 0,0182 | 3,65 | 0,1965 | 0,0286 |
| A14- | Bludenz Nüziders | Nenzing Bludesch | 1,31 | 0,0912 | 0,0047 | 1,31 | 0,0912 | 0,0073 | 1,84 | 0,1276 | 0,0107 | 1,84 | 0,1276 | 0,0168 | 2,71 | 0,1459 | 0,0135 | 2,71 | 0,1459 | 0,0212 |
| A14- | Brandnertal | Bludenz Nüziders | 0,18 | 0,0127 | 0,0006 | 0,18 | 0,0127 | 0,0010 | 0,26 | 0,0178 | 0,0015 | 0,26 | 0,0178 | 0,0023 | 0,38 | 0,0203 | 0,0019 | 0,38 | 0,0203 | 0,0030 |
| A14- | Bludenz Bürs | Brandnertal | 0,30 | 0,0212 | 0,0011 | 0,30 | 0,0212 | 0,0017 | 0,43 | 0,0296 | 0,0025 | 0,43 | 0,0296 | 0,0039 | 0,63 | 0,0339 | 0,0031 | 0,63 | 0,0339 | 0,0049 |
| A14- | Bludenz Montafon | Bludenz Bürs | 0,43 | 0,030 | | | | | | | | | | | | | | | | |

| | | | | | | | | | | | | | | | | | | | | |
|------|--------------------------------------|--------------------------------------|------|--------|--------|------|--------|--------|------|--------|--------|------|--------|--------|------|--------|--------|------|--------|--------|
| A22- | Strebersdorf | KN Gürtel Nordbrücke | 0,59 | 0,0412 | 0,0021 | 0,59 | 0,0412 | 0,0033 | 0,83 | 0,0577 | 0,0048 | 0,83 | 0,0577 | 0,0076 | 1,22 | 0,0659 | 0,0061 | 1,23 | 0,0659 | 0,0096 |
| A221 | KN Gürtel Nordbrücke | Wien Nordbrücke | 0,17 | 0,0122 | 0,0006 | 0,17 | 0,0122 | 0,0010 | 0,24 | 0,0170 | 0,0014 | 0,25 | 0,0170 | 0,0022 | 0,36 | 0,0194 | 0,0018 | 0,36 | 0,0194 | 0,0028 |
| A221 | Wien Pragerstraße | KN Gürtel Nordbrücke | 0,19 | 0,0131 | 0,0007 | 0,19 | 0,0131 | 0,0011 | 0,26 | 0,0183 | 0,0015 | 0,26 | 0,0183 | 0,0024 | 0,39 | 0,0209 | 0,0019 | 0,39 | 0,0209 | 0,0030 |
| A221 | Wien Neujedlersdorf | Wien Pragerstraße | 0,08 | 0,0057 | 0,0003 | 0,08 | 0,0057 | 0,0005 | 0,12 | 0,0080 | 0,0007 | 0,12 | 0,0080 | 0,0011 | 0,17 | 0,0092 | 0,0008 | 0,17 | 0,0092 | 0,0013 |
| A221 | Brünnerstr/Shuttlewort hstraße | Wien Neujedlersdorf | 0,21 | 0,0145 | 0,0007 | 0,21 | 0,0145 | 0,0012 | 0,29 | 0,0203 | 0,0017 | 0,29 | 0,0203 | 0,0027 | 0,43 | 0,0232 | 0,0022 | 0,43 | 0,0232 | 0,0034 |
| A22- | Korneuburg Ost | Strebersdorf | 1,19 | 0,0830 | 0,0042 | 1,19 | 0,0830 | 0,0067 | 1,67 | 0,1162 | 0,0098 | 1,68 | 0,1162 | 0,0153 | 2,46 | 0,1328 | 0,0123 | 2,47 | 0,1328 | 0,0193 |
| A222 | Wien Vohburggasse | Strebersdorf | 0,15 | 0,0103 | 0,0005 | 0,15 | 0,0103 | 0,0008 | 0,21 | 0,0144 | 0,0012 | 0,21 | 0,0144 | 0,0019 | 0,31 | 0,0165 | 0,0015 | 0,31 | 0,0165 | 0,0024 |
| A22- | KN Korneuburg | Korneuburg Ost | 0,77 | 0,0536 | 0,0027 | 0,77 | 0,0536 | 0,0043 | 1,08 | 0,0750 | 0,0063 | 1,08 | 0,0750 | 0,0099 | 1,59 | 0,0857 | 0,0079 | 1,59 | 0,0857 | 0,0125 |
| A22- | Stockerau Ost | KN Korneuburg | 1,12 | 0,0780 | 0,0040 | 1,12 | 0,0780 | 0,0063 | 1,57 | 0,1091 | 0,0092 | 1,57 | 0,1091 | 0,0144 | 2,31 | 0,1247 | 0,0116 | 2,32 | 0,1247 | 0,0182 |
| A22- | Stockerau Mitte | Stockerau Ost | 0,45 | 0,0311 | 0,0016 | 0,45 | 0,0311 | 0,0025 | 0,63 | 0,0435 | 0,0037 | 0,63 | 0,0435 | 0,0057 | 0,92 | 0,0497 | 0,0046 | 0,93 | 0,0497 | 0,0072 |
| A22- | KN Stockerau/West | Stockerau Mitte | 0,38 | 0,0264 | 0,0013 | 0,38 | 0,0264 | 0,0021 | 0,53 | 0,0370 | 0,0031 | 0,53 | 0,0370 | 0,0049 | 0,78 | 0,0422 | 0,0039 | 0,79 | 0,0422 | 0,0061 |
| A23- | KN Wien Inzersdorf | Altmannsdorferstraße | 0,33 | 0,0231 | 0,0012 | 0,33 | 0,0231 | 0,0019 | 0,47 | 0,0323 | 0,0027 | 0,47 | 0,0323 | 0,0043 | 0,69 | 0,0370 | 0,0034 | 0,69 | 0,0370 | 0,0054 |
| A23- | Favoriten | KN Wien Inzersdorf | 0,84 | 0,0583 | 0,0030 | 0,84 | 0,0583 | 0,0047 | 1,17 | 0,0816 | 0,0068 | 1,18 | 0,0816 | 0,0108 | 1,73 | 0,0932 | 0,0086 | 1,73 | 0,0932 | 0,0136 |
| A23- | KN Gürtel Landstraßer Hauptstraße | Favoriten | 0,52 | 0,0365 | 0,0019 | 0,52 | 0,0365 | 0,0029 | 0,73 | 0,0511 | 0,0043 | 0,74 | 0,0511 | 0,0067 | 1,08 | 0,0584 | 0,0054 | 1,09 | 0,0584 | 0,0085 |
| A23- | St. Marx | KN Gürtel Landstraßer Hauptstraße | 0,20 | 0,0139 | 0,0007 | 0,20 | 0,0139 | 0,0011 | 0,28 | 0,0194 | 0,0016 | 0,28 | 0,0194 | 0,0026 | 0,41 | 0,0222 | 0,0021 | 0,41 | 0,0222 | 0,0032 |
| A23- | KN Wien Prater | St. Marx | 0,17 | 0,0118 | 0,0006 | 0,17 | 0,0118 | 0,0009 | 0,24 | 0,0165 | 0,0014 | 0,24 | 0,0165 | 0,0022 | 0,35 | 0,0188 | 0,0017 | 0,35 | 0,0188 | 0,0027 |
| A23- | Handelskai | KN Wien Prater | 0,37 | 0,0261 | 0,0013 | 0,38 | 0,0261 | 0,0021 | 0,53 | 0,0365 | 0,0031 | 0,53 | 0,0365 | 0,0048 | 0,77 | 0,0418 | 0,0039 | 0,78 | 0,0418 | 0,0061 |
| A23- | KN Wien Kaisermühlen | Handelskai | 0,17 | 0,0119 | 0,0006 | 0,17 | 0,0119 | 0,0010 | 0,24 | 0,0167 | 0,0014 | 0,24 | 0,0167 | 0,0022 | 0,35 | 0,0191 | 0,0018 | 0,36 | 0,0191 | 0,0028 |
| A23- | Groß Enzersdorf Stadlau | KN Wien Kaisermühlen | 0,47 | 0,0327 | 0,0017 | 0,47 | 0,0327 | 0,0026 | 0,66 | 0,0458 | 0,0038 | 0,66 | 0,0458 | 0,0060 | 0,97 | 0,0524 | 0,0049 | 0,97 | 0,0524 | 0,0076 |
| A23- | Hirschstetten | Groß Enzersdorf Stadlau | 0,26 | 0,0184 | 0,0009 | 0,26 | 0,0184 | 0,0015 | 0,37 | 0,0257 | 0,0022 | 0,37 | 0,0257 | 0,0034 | 0,54 | 0,0294 | 0,0027 | 0,55 | 0,0294 | 0,0043 |
| A233 | Wien Gürtel | KN Gürtel Landstraßer Hauptstraße | 0,15 | 0,0107 | 0,0005 | 0,15 | 0,0107 | 0,0009 | 0,22 | 0,0150 | 0,0013 | 0,22 | 0,0150 | 0,0020 | 0,32 | 0,0171 | 0,0016 | 0,32 | 0,0171 | 0,0025 |
| A25- | Weißkirchen | KN A1/A25 Passau Wels | 1,73 | 0,1208 | 0,0062 | 1,74 | 0,1208 | 0,0097 | 2,43 | 0,1691 | 0,0142 | 2,44 | 0,1691 | 0,0223 | 3,58 | 0,1932 | 0,0179 | 3,59 | 0,1932 | 0,0281 |
| A25- | Marchtrenk Wels Ost | Weißkirchen | 0,62 | 0,0430 | 0,0022 | 0,62 | 0,0430 | 0,0035 | 0,87 | 0,0602 | 0,0051 | 0,87 | 0,0602 | 0,0079 | 1,28 | 0,0689 | 0,0064 | 1,28 | 0,0689 | 0,0100 |
| A25- | ÖBB Terminal Wels | Marchtrenk Wels Ost | 0,17 | 0,0116 | 0,0006 | 0,17 | 0,0116 | 0,0009 | 0,23 | 0,0162 | 0,0014 | 0,23 | 0,0162 | 0,0021 | 0,34 | 0,0185 | 0,0017 | 0,34 | 0,0185 | 0,0027 |
| A25- | Wels Nord | ÖBB Terminal Wels | 0,80 | 0,0555 | 0,0028 | 0,80 | 0,0555 | 0,0045 | 1,12 | 0,0777 | 0,0065 | 1,12 | 0,0777 | 0,0102 | 1,65 | 0,0888 | 0,0082 | 1,65 | 0,0888 | 0,0129 |
| A25- | KN Wels | Wels Nord | 0,57 | 0,0395 | 0,0020 | 0,57 | 0,0395 | 0,0032 | 0,80 | 0,0553 | 0,0046 | 0,80 | 0,0553 | 0,0073 | 1,17 | 0,0632 | 0,0059 | 1,18 | 0,0632 | 0,0092 |
| S01- | Vorarlberger Allee | KN Vösendorf | 0,42 | 0,0293 | 0,0015 | 0,42 | 0,0293 | 0,0024 | 0,59 | 0,0410 | 0,0034 | 0,59 | 0,0410 | 0,0054 | 0,87 | 0,0468 | 0,0043 | 0,87 | 0,0468 | 0,0068 |
| S01- | Laxenburger Str. | Vorarlberger Allee | 0,22 | 0,0154 | 0,0008 | 0,22 | 0,0154 | 0,0012 | 0,31 | 0,0215 | 0,0018 | 0,31 | 0,0215 | 0,0028 | 0,46 | 0,0246 | 0,0023 | 0,46 | 0,0246 | 0,0036 |
| S01- | Güterzentrum Wien Süd | Laxenburger Str. | 0,27 | 0,0191 | 0,0010 | 0,27 | 0,0191 | 0,0015 | 0,38 | 0,0267 | 0,0022 | 0,39 | 0,0267 | 0,0035 | 0,57 | 0,0305 | 0,0028 | 0,57 | 0,0305 | 0,0044 |
| S01- | Rothneusiedl | Güterzentrum Wien Süd | 0,18 | 0,0124 | 0,0006 | 0,18 | 0,0124 | 0,0010 | 0,25 | 0,0173 | 0,0015 | 0,25 | 0,0173 | 0,0023 | 0,37 | 0,0198 | 0,0018 | 0,37 | 0,0198 | 0,0029 |
| S01- | KN Rustenfeld | Rothneusiedl | 0,42 | 0,0290 | 0,0015 | 0,42 | 0,0290 | 0,0023 | 0,58 | 0,0406 | 0,0034 | 0,59 | 0,0406 | 0,0054 | 0,86 | 0,0464 | 0,0043 | 0,86 | 0,0464 | 0,0067 |
| S01- | Rannersdorf | KN Rustenfeld | 0,58 | 0,0407 | 0,0021 | 0,58 | 0,0407 | 0,0033 | 0,82 | 0,0569 | 0,0048 | 0,82 | 0,0569 | 0,0075 | 1,21 | 0,0651 | 0,0060 | 1,21 | 0,0651 | 0,0095 |
| S011 | Leopoldsdorf (B16) | KN Rustenfeld | 0,26 | 0,0180 | 0,0009 | 0,26 | 0,0180 | 0,0014 | 0,36 | 0,0252 | 0,0021 | 0,36 | 0,0252 | 0,0033 | 0,53 | 0,0288 | 0,0027 | 0,54 | 0,0288 | 0,0042 |
| S01- | Schwechat Süd | Rannersdorf | 0,46 | 0,0318 | 0,0016 | 0,46 | 0,0318 | 0,0026 | 0,64 | 0,0445 | 0,0037 | 0,64 | 0,0445 | 0,0059 | 0,94 | 0,0508 | 0,0047 | 0,95 | 0,0508 | 0,0074 |
| S01- | Schwechat Ost | Schwechat Süd | 0,26 | 0,0182 | 0,0009 | 0,26 | 0,0182 | 0,0015 | 0,37 | 0,0255 | 0,0021 | 0,37 | 0,0255 | 0,0034 | 0,54 | 0,0291 | 0,0027 | 0,54 | 0,0291 | 0,0042 |
| S01- | Mannswörth | Schwechat Ost | 0,28 | 0,0193 | 0,0010 | 0,28 | 0,0193 | 0,0015 | 0,39 | 0,0270 | 0,0023 | 0,39 | 0,0270 | 0,0036 | 0,57 | 0,0308 | 0,0029 | 0,57 | 0,0308 | 0,0045 |
| S01- | KN Schwechat | Mannswörth | 0,10 | 0,0072 | 0,0004 | 0,10 | 0,0072 | 0,0006 | 0,15 | 0,0101 | 0,0008 | 0,15 | 0,0101 | 0,0013 | 0,21 | 0,0116 | 0,0011 | 0,21 | 0,0116 | 0,0017 |
| S01- | Seyring | Angerner Straße | 0,97 | 0,0675 | 0,0034 | 0,97 | 0,0675 | 0,0054 | 1,36 | 0,0945 | 0,0079 | 1,36 | 0,0945 | 0,0125 | 2,00 | 0,1080 | 0,0100 | 2,01 | 0,1080 | 0,0157 |
| S01- | KN Eibesbrunn | Seyring | 0,81 | 0,0565 | 0,0029 | 0,81 | 0,0565 | 0,0045 | 1,14 | 0,0791 | 0,0066 | 1,14 | 0,0791 | 0,0104 | 1,68 | 0,0904 | 0,0084 | 1,68 | 0,0904 | 0,0131 |
| S01- | Hagenbrunn | KN Eibesbrunn | 0,64 | 0,0445 | 0,0023 | 0,64 | 0,0445 | 0,0036 | 0,90 | 0,0622 | 0,0052 | 0,90 | 0,0622 | 0,0082 | 1,32 | 0,0711 | 0,0066 | 1,32 | 0,0711 | 0,0104 |
| S01- | Korneuburg Nord | Hagenbrunn | 1,36 | 0,0951 | 0,0049 | 1,37 | 0,0951 | 0,0076 | 1,92 | 0,1331 | 0,0112 | 1,92 | 0,1331 | 0,0176 | 2,82 | 0,1522 | 0,0141 | 2,83 | 0,1522 | 0,0221 |
| S01- | Korneuburg West | Korneuburg Nord | 0,55 | 0,0386 | 0,0020 | 0,55 | 0,0386 | 0,0031 | 0,78 | 0,0540 | 0,0045 | 0,78 | 0,0540 | 0,0071 | 1,14 | 0,0617 | 0,0057 | 1,15 | 0,0617 | 0,0090 |
| S01- | KN Korneuburg | Korneuburg West | 0,18 | 0,0123 | 0,0006 | 0,18 | 0,0123 | 0,0010 | 0,25 | 0,0172 | 0,0014 | 0,25 | 0,0172 | 0,0023 | 0,37 | 0,0197 | 0,0018 | 0,37 | 0,0197 | 0,0029 |
| S02- | Gewerbepark Stadlau | Hirschstetten | 0,19 | 0,0132 | 0,0007 | 0,19 | 0,0132 | 0,0011 | 0,27 | 0,0185 | 0,0016 | 0,27 | 0,0185 | 0,0024 | 0,39 | 0,0212 | 0,0020 | 0,39 | 0,0212 | 0,0031 |
| S02- | Breitenleer Straße | Gewerbepark Stadlau | 0,11 | 0,0073 | 0,0004 | 0,11 | 0,0073 | 0,0006 | 0,15 | 0,0103 | 0,0009 | 0,15 | 0,0103 | 0,0014 | 0,22 | 0,0117 | 0,0011 | 0,22 | 0,0117 | 0,0017 |
| S02- | Rautenweg | Breitenleer Straße | 0,17 | 0,0122 | 0,0006 | 0,18 | 0,0122 | 0,0010 | 0,24 | 0,0170 | 0,0014 | 0,25 | 0,0170 | 0,0022 | 0,36 | 0,0195 | 0,0018 | 0,36 | 0,0195 | 0,0028 |
| S02- | Hermann Gebauer Straße | Rautenweg | 0,19 | 0,0134 | 0,0007 | 0,19 | 0,0134 | 0,0011 | 0,27 | 0,0187 | 0,0016 | 0,27 | 0,0187 | 0,0025 | 0,40 | 0,0214 | 0,0020 | 0,40 | 0,0214 | 0,0031 |
| S02- | Angerner Straße | Hermann Gebauer Straße | 0,69 | 0,0484 | 0,0025 | 0,70 | 0,0484 | 0,0039 | 0,97 | 0,0677 | 0,0057 | 0,98 | 0,0677 | 0,0089 | 1,44 | 0,0774 | 0,0072 | 1,44 | 0,0774 | 0,0113 |
| S03- | Stockerau Nord | KN Stockerau/West | 0,20 | 0,0137 | 0,0007 | 0,20 | 0,0137 | 0,0011 | 0,28 | 0,0191 | 0,0016 | 0,28 | 0,0191 | 0,0025 | 0,41 | 0,0219 | 0,0020 | 0,41 | 0,0219 | 0,0032 |
| S03- | Sierndorf | Stockerau Nord | 1,05 | 0,0735 | 0,0038 | 1,06 | 0,0735 | 0,0059 | 1,48 | 0,1029 | 0,0086 | 1,48 | 0,1029 | 0,0136 | 2,18 | 0,1176 | 0,0109 | 2,19 | 0,1176 | 0,0171 |
| S03- | Obermallebarn | Sierndorf | 0,71 | 0,0493 | 0,0025 | 0,71 | 0,0493 | 0,0040 | 0,99 | 0,0691 | 0,0058 | 1,00 | 0,0691 | 0,0091 | 1,46 | 0,0790 | 0,0073 | 1,47 | 0,0790 | 0,0115 |
| S03- | Göllersdorf | Obermallebarn | 0,94 | 0,0652 | 0,0033 | 0,94 | 0,0652 | 0,0052 | 1,31 | 0,0912 | 0,0077 | 1,32 | 0,0912 | 0,0120 | 1,93 | 0,1043 | 0,0097 | 1,94 | 0,1043 | 0,0152 |
| S03- | Großstelzendorf | Göllersdorf | 0,37 | 0,0261 | 0,0013 | 0,38 | 0,0261 | 0,0021 | 0,53 | 0,0365 | 0,0031 | 0,53 | 0,0365 | 0,0048 | 0,77 | 0,0418 | 0,0039 | 0,78 | 0,0418 | 0,0061 |
| S03- | Hollabrunn Süd | Großstelzendorf | 0,90 | 0,0628 | 0,0032 | 0,90 | 0,0628 | 0,0050 | 1,26 | 0,0879 | 0,0074 | 1,27 | 0,0879 | 0,0116 | 1,86 | 0,1004 | 0,0093 | 1,87 | 0,1004 | 0,0146 |
| S04- | Sigleß | KN Mattersburg | 0,47 | 0,0324 | 0,0017 | 0,47 | 0,0324 | 0,0026 | 0,65 | 0,0454 | 0,0038 | 0,66 | 0,0454 | 0,0060 | 0,96 | 0,0519 | 0,0048 | 0,97 | 0,0519 | 0,0076 |
| S04- | Bad Sauerbrunn | Sigleß | 1,09 | 0,0758 | 0,0039 | 1,09 | 0,0758 | 0,0061 | 1,53 | 0,1061 | 0,0089 | 1,53 | 0,1061 | 0,0140 | 2,25 | 0,1213 | 0,0112 | 2,26 | 0,1213 | 0,0177 |
| S04- | | | | | | | | | | | | | | | | | | | | |

| | | | | | | | | | | | | | | | | | | | | |
|------|-----------------------------------|-----------------------------------|------|--------|--------|------|--------|--------|-------|--------|--------|-------|--------|--------|-------|--------|--------|-------|--------|--------|
| S06- | Gloggnitz | Neunkirchen | 2,39 | 0,1667 | 0,0085 | 2,40 | 0,1667 | 0,0134 | 3,36 | 0,2334 | 0,0196 | 3,37 | 0,2334 | 0,0308 | 4,95 | 0,2668 | 0,0247 | 4,96 | 0,2668 | 0,0388 |
| S06- | Maria Schutz | Gloggnitz | 1,53 | 0,1063 | 0,0054 | 1,53 | 0,1063 | 0,0085 | 2,14 | 0,1488 | 0,0125 | 2,15 | 0,1488 | 0,0196 | 3,15 | 0,1700 | 0,0157 | 3,16 | 0,1700 | 0,0247 |
| S06- | Spital / Semmering | Maria Schutz | 1,29 | 0,0902 | 0,0046 | 1,30 | 0,0902 | 0,0072 | 1,82 | 0,1263 | 0,0106 | 1,82 | 0,1263 | 0,0167 | 2,68 | 0,1443 | 0,0134 | 2,68 | 0,1443 | 0,0210 |
| S06- | Mürzzuschlag Ost | Spital / Semmering | 1,08 | 0,0754 | 0,0039 | 1,08 | 0,0754 | 0,0061 | 1,52 | 0,1055 | 0,0089 | 1,52 | 0,1055 | 0,0139 | 2,24 | 0,1206 | 0,0112 | 2,24 | 0,1206 | 0,0175 |
| S06- | Mariazell, Mürzsteg, Mürzzuschlag | Mürzzuschlag Ost | 0,96 | 0,0668 | 0,0034 | 0,96 | 0,0668 | 0,0054 | 1,35 | 0,0935 | 0,0079 | 1,35 | 0,0935 | 0,0123 | 1,98 | 0,1069 | 0,0099 | 1,99 | 0,1069 | 0,0156 |
| S06- | Hönigsberg | Mariazell, Mürzsteg, Mürzzuschlag | 0,68 | 0,0476 | 0,0024 | 0,68 | 0,0476 | 0,0038 | 0,96 | 0,0667 | 0,0056 | 0,96 | 0,0667 | 0,0088 | 1,41 | 0,0762 | 0,0071 | 1,42 | 0,0762 | 0,0111 |
| S06- | Langenwang | Hönigsberg | 0,38 | 0,0263 | 0,0013 | 0,38 | 0,0263 | 0,0021 | 0,53 | 0,0369 | 0,0031 | 0,53 | 0,0369 | 0,0049 | 0,78 | 0,0422 | 0,0039 | 0,78 | 0,0422 | 0,0061 |
| S06- | Krieglach | Langenwang | 0,45 | 0,0313 | 0,0016 | 0,45 | 0,0313 | 0,0025 | 0,63 | 0,0438 | 0,0037 | 0,63 | 0,0438 | 0,0058 | 0,93 | 0,0501 | 0,0046 | 0,93 | 0,0501 | 0,0073 |
| S06- | Mitterdorf | Krieglach | 1,13 | 0,0791 | 0,0040 | 1,14 | 0,0791 | 0,0064 | 1,59 | 0,1107 | 0,0093 | 1,60 | 0,1107 | 0,0146 | 2,35 | 0,1265 | 0,0117 | 2,35 | 0,1265 | 0,0184 |
| S06- | Kindberg Ost | Mitterdorf | 1,15 | 0,0804 | 0,0041 | 1,16 | 0,0804 | 0,0065 | 1,62 | 0,1126 | 0,0095 | 1,62 | 0,1126 | 0,0149 | 2,39 | 0,1287 | 0,0119 | 2,39 | 0,1287 | 0,0187 |
| S06- | Kindberg West | Kindberg Ost | 0,25 | 0,0173 | 0,0009 | 0,25 | 0,0173 | 0,0014 | 0,35 | 0,0242 | 0,0020 | 0,35 | 0,0242 | 0,0032 | 0,51 | 0,0276 | 0,0026 | 0,51 | 0,0276 | 0,0040 |
| S06- | Kindberg Dörfel | Kindberg West | 0,25 | 0,0172 | 0,0009 | 0,25 | 0,0172 | 0,0014 | 0,35 | 0,0241 | 0,0020 | 0,35 | 0,0241 | 0,0032 | 0,51 | 0,0276 | 0,0026 | 0,51 | 0,0276 | 0,0040 |
| S06- | Allerheiligen Mürzhofen | Kindberg Dörfel | 0,56 | 0,0389 | 0,0020 | 0,56 | 0,0389 | 0,0031 | 0,78 | 0,0544 | 0,0046 | 0,79 | 0,0544 | 0,0072 | 1,15 | 0,0622 | 0,0058 | 1,16 | 0,0622 | 0,0090 |
| S06- | St. Marein | Allerheiligen Mürzhofen | 0,84 | 0,0584 | 0,0030 | 0,84 | 0,0584 | 0,0047 | 1,18 | 0,0817 | 0,0069 | 1,18 | 0,0817 | 0,0108 | 1,73 | 0,0934 | 0,0086 | 1,74 | 0,0934 | 0,0136 |
| S06- | Kapfenberg | St. Marein | 0,59 | 0,0414 | 0,0021 | 0,59 | 0,0414 | 0,0033 | 0,83 | 0,0579 | 0,0049 | 0,84 | 0,0579 | 0,0076 | 1,23 | 0,0662 | 0,0061 | 1,23 | 0,0662 | 0,0096 |
| S06- | KN Bruck/Mur | Kapfenberg | 1,11 | 0,0772 | 0,0039 | 1,11 | 0,0772 | 0,0062 | 1,56 | 0,1081 | 0,0091 | 1,56 | 0,1081 | 0,0143 | 2,29 | 0,1236 | 0,0114 | 2,30 | 0,1236 | 0,0180 |
| S06- | ASt Bruck/Mur | KN Bruck/Mur | 0,95 | 0,0663 | 0,0034 | 0,95 | 0,0663 | 0,0053 | 1,33 | 0,0928 | 0,0078 | 1,34 | 0,0928 | 0,0122 | 1,97 | 0,1060 | 0,0098 | 1,97 | 0,1060 | 0,0154 |
| S06- | Niklasdorf | ASt Bruck/Mur | 0,88 | 0,0612 | 0,0031 | 0,88 | 0,0612 | 0,0049 | 1,23 | 0,0857 | 0,0072 | 1,24 | 0,0857 | 0,0113 | 1,82 | 0,0979 | 0,0091 | 1,82 | 0,0979 | 0,0143 |
| S06- | Leoben Ost | Niklasdorf | 0,94 | 0,0653 | 0,0033 | 0,94 | 0,0653 | 0,0052 | 1,31 | 0,0914 | 0,0077 | 1,32 | 0,0914 | 0,0121 | 1,94 | 0,1045 | 0,0097 | 1,94 | 0,1045 | 0,0152 |
| S06- | Leoben West | Leoben Ost | 1,05 | 0,0731 | 0,0037 | 1,05 | 0,0731 | 0,0059 | 1,47 | 0,1024 | 0,0086 | 1,48 | 0,1024 | 0,0135 | 2,17 | 0,1170 | 0,0108 | 2,18 | 0,1170 | 0,0170 |
| S06- | KN St. Michael | Leoben West | 1,30 | 0,0905 | 0,0046 | 1,30 | 0,0905 | 0,0073 | 1,82 | 0,1268 | 0,0106 | 1,83 | 0,1268 | 0,0167 | 2,69 | 0,1449 | 0,0134 | 2,69 | 0,1449 | 0,0211 |
| S10- | Neumarkt | Unterweikersdorf | 1,32 | 0,0917 | 0,0047 | 1,32 | 0,0917 | 0,0074 | 1,85 | 0,1284 | 0,0108 | 1,85 | 0,1284 | 0,0169 | 2,72 | 0,1468 | 0,0136 | 2,73 | 0,1468 | 0,0214 |
| S10- | Kefermarkt | Neumarkt | 0,76 | 0,0527 | 0,0027 | 0,76 | 0,0527 | 0,0042 | 1,06 | 0,0738 | 0,0062 | 1,06 | 0,0738 | 0,0097 | 1,56 | 0,0843 | 0,0078 | 1,57 | 0,0843 | 0,0123 |
| S10- | Freistadt / Süd | Kefermarkt | 0,81 | 0,0567 | 0,0029 | 0,82 | 0,0567 | 0,0046 | 1,14 | 0,0793 | 0,0067 | 1,15 | 0,0793 | 0,0105 | 1,68 | 0,0907 | 0,0084 | 1,69 | 0,0907 | 0,0132 |
| S10- | Grünbach Sandl | Freistadt / Süd | 0,86 | 0,0600 | 0,0031 | 0,86 | 0,0600 | 0,0048 | 1,21 | 0,0839 | 0,0070 | 1,21 | 0,0839 | 0,0111 | 1,78 | 0,0959 | 0,0089 | 1,78 | 0,0959 | 0,0140 |
| S10- | Freistadt / Nord | Grünbach Sandl | 0,24 | 0,0165 | 0,0008 | 0,24 | 0,0165 | 0,0013 | 0,33 | 0,0231 | 0,0019 | 0,33 | 0,0231 | 0,0030 | 0,49 | 0,0263 | 0,0024 | 0,49 | 0,0263 | 0,0038 |
| S16- | Landeck West | Zams | 1,01 | 0,0701 | 0,0036 | 1,01 | 0,0701 | 0,0056 | 1,41 | 0,0981 | 0,0082 | 1,42 | 0,0981 | 0,0129 | 2,08 | 0,1121 | 0,0104 | 2,09 | 0,1121 | 0,0163 |
| S16- | Pians | Landeck West | 0,64 | 0,0449 | 0,0023 | 0,65 | 0,0449 | 0,0036 | 0,90 | 0,0628 | 0,0053 | 0,91 | 0,0628 | 0,0083 | 1,33 | 0,0718 | 0,0067 | 1,34 | 0,0718 | 0,0105 |
| S16- | Flirsch | Pians | 1,28 | 0,0890 | 0,0045 | 1,28 | 0,0890 | 0,0071 | 1,79 | 0,1245 | 0,0105 | 1,80 | 0,1245 | 0,0164 | 2,64 | 0,1423 | 0,0132 | 2,65 | 0,1423 | 0,0207 |
| S16- | Schnann am Arlberg | Flirsch | 0,80 | 0,0558 | 0,0029 | 0,80 | 0,0558 | 0,0045 | 1,12 | 0,0782 | 0,0066 | 1,13 | 0,0782 | 0,0103 | 1,66 | 0,0893 | 0,0083 | 1,66 | 0,0893 | 0,0130 |
| S16- | Pettneu | Schnann am Arlberg | 0,58 | 0,0406 | 0,0021 | 0,58 | 0,0406 | 0,0033 | 0,82 | 0,0568 | 0,0048 | 0,82 | 0,0568 | 0,0075 | 1,20 | 0,0649 | 0,0060 | 1,21 | 0,0649 | 0,0095 |
| S16- | St. Anton/Arlberg | Pettneu | 0,32 | 0,0226 | 0,0012 | 0,33 | 0,0226 | 0,0018 | 0,46 | 0,0316 | 0,0027 | 0,46 | 0,0316 | 0,0042 | 0,67 | 0,0362 | 0,0033 | 0,67 | 0,0362 | 0,0053 |
| S16- | Langen/Arlberg | St. Anton/Arlberg | 8,01 | 0,2199 | 0,0112 | 8,01 | 0,2199 | 0,0177 | 11,22 | 0,3079 | 0,0258 | 11,23 | 0,3079 | 0,0406 | 16,71 | 0,3519 | 0,0326 | 16,73 | 0,3519 | 0,0512 |
| S16- | Wald/Arlberg | Langen/Arlberg | 1,03 | 0,0720 | 0,0037 | 1,04 | 0,0720 | 0,0058 | 1,45 | 0,1008 | 0,0085 | 1,46 | 0,1008 | 0,0133 | 2,14 | 0,1153 | 0,0107 | 2,14 | 0,1153 | 0,0168 |
| S16- | Dalaas | Wald/Arlberg | 1,18 | 0,0820 | 0,0042 | 1,18 | 0,0820 | 0,0066 | 1,65 | 0,1149 | 0,0096 | 1,66 | 0,1149 | 0,0152 | 2,44 | 0,1313 | 0,0122 | 2,44 | 0,1313 | 0,0191 |
| S16- | Braz Ost | Dalaas | 0,67 | 0,0465 | 0,0024 | 0,67 | 0,0465 | 0,0037 | 0,94 | 0,0651 | 0,0055 | 0,94 | 0,0651 | 0,0086 | 1,38 | 0,0744 | 0,0069 | 1,38 | 0,0744 | 0,0108 |
| S16- | Braz West | Braz Ost | 0,52 | 0,0363 | 0,0019 | 0,52 | 0,0363 | 0,0029 | 0,73 | 0,0508 | 0,0043 | 0,73 | 0,0508 | 0,0067 | 1,08 | 0,0581 | 0,0054 | 1,08 | 0,0581 | 0,0085 |
| S16- | Bings | Braz West | 0,71 | 0,0492 | 0,0025 | 0,71 | 0,0492 | 0,0039 | 0,99 | 0,0688 | 0,0058 | 0,99 | 0,0688 | 0,0091 | 1,46 | 0,0787 | 0,0073 | 1,46 | 0,0787 | 0,0114 |
| S16- | Bludenz Montafon | Bings | 0,33 | 0,0233 | 0,0012 | 0,33 | 0,0233 | 0,0019 | 0,47 | 0,0326 | 0,0027 | 0,47 | 0,0326 | 0,0043 | 0,69 | 0,0372 | 0,0034 | 0,69 | 0,0372 | 0,0054 |
| S31- | Eisenstadt Süd | Eisenstadt Ost | 0,61 | 0,0422 | 0,0022 | 0,61 | 0,0422 | 0,0034 | 0,85 | 0,0591 | 0,0050 | 0,85 | 0,0591 | 0,0078 | 1,25 | 0,0675 | 0,0063 | 1,26 | 0,0675 | 0,0098 |
| S31- | Eisenstadt Mitte | Eisenstadt Süd | 0,23 | 0,0158 | 0,0008 | 0,23 | 0,0158 | 0,0013 | 0,32 | 0,0221 | 0,0019 | 0,32 | 0,0221 | 0,0029 | 0,47 | 0,0253 | 0,0023 | 0,47 | 0,0253 | 0,0037 |
| S31- | KN Eisenstadt | Eisenstadt Mitte | 0,37 | 0,0261 | 0,0013 | 0,37 | 0,0261 | 0,0021 | 0,52 | 0,0365 | 0,0031 | 0,53 | 0,0365 | 0,0048 | 0,77 | 0,0417 | 0,0039 | 0,78 | 0,0417 | 0,0061 |
| S31- | Wulkaprodersdorf | KN Eisenstadt | 0,50 | 0,0347 | 0,0018 | 0,50 | 0,0347 | 0,0028 | 0,70 | 0,0486 | 0,0041 | 0,70 | 0,0486 | 0,0064 | 1,03 | 0,0555 | 0,0051 | 1,03 | 0,0555 | 0,0081 |
| S31- | KN Mattersburg | Wulkaprodersdorf | 1,41 | 0,0985 | 0,0050 | 1,42 | 0,0985 | 0,0079 | 1,98 | 0,1379 | 0,0116 | 1,99 | 0,1379 | 0,0182 | 2,92 | 0,1576 | 0,0146 | 2,93 | 0,1576 | 0,0229 |
| S31- | Forchtenstein | KN Mattersburg | 1,02 | 0,0713 | 0,0036 | 1,03 | 0,0713 | 0,0057 | 1,44 | 0,0998 | 0,0084 | 1,44 | 0,0998 | 0,0132 | 2,12 | 0,1140 | 0,0106 | 2,12 | 0,1140 | 0,0166 |
| S31- | Sieggraben | Forchtenstein | 1,43 | 0,0996 | 0,0051 | 1,43 | 0,0996 | 0,0080 | 2,01 | 0,1394 | 0,0117 | 2,01 | 0,1394 | 0,0184 | 2,96 | 0,1594 | 0,0148 | 2,96 | 0,1594 | 0,0232 |
| S31- | Weppersdorf/Kobersdorf | Sieggraben | 1,72 | 0,1200 | 0,0061 | 1,73 | 0,1200 | 0,0096 | 2,42 | 0,1680 | 0,0141 | 2,42 | 0,1680 | 0,0222 | 3,56 | 0,1920 | 0,0178 | 3,57 | 0,1920 | 0,0279 |
| S31- | Weppersdorf/Markt St.Martin | Weppersdorf/Kobersdorf | 0,35 | 0,0246 | 0,0013 | 0,35 | 0,0246 | 0,0020 | 0,50 | 0,0345 | 0,0029 | 0,50 | 0,0345 | 0,0046 | 0,73 | 0,0394 | 0,0037 | 0,73 | 0,0394 | 0,0057 |
| S31- | Neutal | Weppersdorf/Markt St.Martin | 0,82 | 0,0570 | 0,0029 | 0,82 | 0,0570 | 0,0046 | 1,15 | 0,0797 | 0,0067 | 1,15 | 0,0797 | 0,0105 | 1,69 | 0,0911 | 0,0084 | 1,70 | 0,0911 | 0,0133 |
| S31- | Stoob Süd | Neutal | 0,71 | 0,0498 | 0,0025 | 0,72 | 0,0498 | 0,0040 | 1,00 | 0,0697 | 0,0058 | 1,01 | 0,0697 | 0,0092 | 1,48 | 0,0796 | 0,0074 | 1,48 | 0,0796 | 0,0116 |
| S31- | Oberpullendorf | Stoob Süd | 0,78 | 0,0543 | 0,0028 | 0,78 | 0,0543 | 0,0044 | 1,09 | 0,0760 | 0,0064 | 1,10 | 0,0760 | 0,0100 | 1,61 | 0,0869 | 0,0080 | 1,62 | 0,0869 | 0,0126 |
| S33- | St. Pölten Ost | KN St. Pölten | 0,42 | 0,0295 | 0,0015 | 0,42 | 0,0295 | 0,0024 | 0,59 | 0,0413 | 0,0035 | 0,60 | 0,0413 | 0,0054 | 0,88 | 0,0472 | 0,0044 | 0,88 | 0,0472 | 0,0069 |
| S33- | St. Pölten Nord | St. Pölten Ost | 0,75 | 0,0521 | 0,0027 | 0,75 | 0,0521 | 0,0042 | 1,05 | 0,0729 | 0,0061 | 1,05 | 0,0729 | 0,0096 | 1,55 | 0,0834 | 0,0077 | 1,55 | 0,0834 | 0,0121 |
| S33- | Herzogenburg Süd | St. Pölten Nord | 0,79 | 0,0552 | 0,0028 | 0,79 | 0,0552 | 0,0044 | 1,11 | 0,0772 | 0,0065 | 1,11 | 0,0772 | 0,0102 | 1,64 | 0,0883 | 0,0082 | 1,64 | 0,0883 | 0,0128 |
| S33- | Herzogenburg Stadt | Herzogenburg Süd | 0,42 | 0,0295 | 0,0015 | 0,42 | 0,0295 | 0,0024 | 0,59 | 0,0412 | 0,0035 | 0,60 | 0,0412 | 0,0054 | 0,87 | 0,0471 | 0,0044 | 0,88 | 0,0471 | 0,0069 |
| S33- | Herzogenburg Nord | Herzogenburg Stadt | 0,23 | 0,0163 | 0,0008 | 0,23 | 0,0163 | 0,0013 | 0,33 | 0,0229 | 0,0019 | 0,33 | 0,0229 | 0,0030 | 0,48 | 0,0261 | 0,0024 | 0,49 | 0,0261 | 0,0038 |
| S33- | Traismauer Süd | Herzogenburg Nord | 1,14 | 0,0795 | 0,0041 | 1,14 | 0,0795 | 0,0064 | 1,60 | | | | | | | | | | | |

| | | | | | | | | | | | | | | | | | | | | |
|------|--------------------------|--------------------------|------|--------|--------|------|--------|--------|------|--------|--------|------|--------|--------|------|--------|--------|------|--------|--------|
| S36- | Zeltweg Ost Spielberg | Knittelfeld West | 0,18 | 0,0127 | 0,0006 | 0,18 | 0,0127 | 0,0010 | 0,26 | 0,0177 | 0,0015 | 0,26 | 0,0177 | 0,0023 | 0,38 | 0,0203 | 0,0019 | 0,38 | 0,0203 | 0,0030 |
| S36- | Zeltweg West | Zeltweg Ost Spielberg | 1,18 | 0,0825 | 0,0042 | 1,19 | 0,0825 | 0,0066 | 1,66 | 0,1155 | 0,0097 | 1,67 | 0,1155 | 0,0152 | 2,45 | 0,1320 | 0,0122 | 2,45 | 0,1320 | 0,0192 |
| S36- | Judenburg Ost Fohnsdorf | Zeltweg West | 0,60 | 0,0415 | 0,0021 | 0,60 | 0,0415 | 0,0033 | 0,84 | 0,0581 | 0,0049 | 0,84 | 0,0581 | 0,0077 | 1,23 | 0,0664 | 0,0061 | 1,23 | 0,0664 | 0,0097 |
| S36- | Judenburg West | Judenburg Ost Fohnsdorf | 0,92 | 0,0643 | 0,0033 | 0,93 | 0,0643 | 0,0052 | 1,30 | 0,0901 | 0,0076 | 1,30 | 0,0901 | 0,0119 | 1,91 | 0,1029 | 0,0095 | 1,91 | 0,1029 | 0,0150 |
| S36- | St. Georgen Ost | As B317 (prov.) | 0,10 | 0,0067 | 0,0003 | 0,10 | 0,0067 | 0,0005 | 0,14 | 0,0094 | 0,0008 | 0,14 | 0,0094 | 0,0012 | 0,20 | 0,0108 | 0,0010 | 0,20 | 0,0108 | 0,0016 |
| S36- | St. Georgen West | St. Georgen Ost | 0,18 | 0,0125 | 0,0006 | 0,18 | 0,0125 | 0,0010 | 0,25 | 0,0174 | 0,0015 | 0,25 | 0,0174 | 0,0023 | 0,37 | 0,0199 | 0,0018 | 0,37 | 0,0199 | 0,0029 |
| S37- | St. Veit Mitte / Brückl | St. Veit Nord | 0,56 | 0,0390 | 0,0020 | 0,56 | 0,0390 | 0,0031 | 0,79 | 0,0546 | 0,0046 | 0,79 | 0,0546 | 0,0072 | 1,16 | 0,0624 | 0,0058 | 1,16 | 0,0624 | 0,0091 |
| S37- | St. Veit Süd | St. Veit Mitte / Brückl | 0,48 | 0,0332 | 0,0017 | 0,48 | 0,0332 | 0,0027 | 0,67 | 0,0464 | 0,0039 | 0,67 | 0,0464 | 0,0061 | 0,98 | 0,0531 | 0,0049 | 0,99 | 0,0531 | 0,0077 |
| S37- | St. Veit Industriegebiet | St. Veit Süd | 0,36 | 0,0249 | 0,0013 | 0,36 | 0,0249 | 0,0020 | 0,50 | 0,0349 | 0,0029 | 0,50 | 0,0349 | 0,0046 | 0,74 | 0,0399 | 0,0037 | 0,74 | 0,0399 | 0,0058 |
| S37- | Maria Saal | St. Veit Industriegebiet | 1,26 | 0,0875 | 0,0045 | 1,26 | 0,0875 | 0,0070 | 1,76 | 0,1225 | 0,0103 | 1,77 | 0,1225 | 0,0162 | 2,60 | 0,1400 | 0,0130 | 2,60 | 0,1400 | 0,0204 |
| S37- | Karnburg | Maria Saal | 0,45 | 0,0312 | 0,0016 | 0,45 | 0,0312 | 0,0025 | 0,63 | 0,0437 | 0,0037 | 0,63 | 0,0437 | 0,0058 | 0,93 | 0,0500 | 0,0046 | 0,93 | 0,0500 | 0,0073 |
| S37- | Klagenfurt Nord | Karnburg | 0,39 | 0,0273 | 0,0014 | 0,39 | 0,0273 | 0,0022 | 0,55 | 0,0382 | 0,0032 | 0,55 | 0,0382 | 0,0050 | 0,81 | 0,0436 | 0,0040 | 0,81 | 0,0436 | 0,0064 |

| Road | Toll road section from | Toll road section to | EURO VI Cat 2 | | | | | | EURO VI Cat 3 | | | | | | EURO VI Cat 4 | | | | | |
|------|----------------------------|----------------------------|---------------|--------|--------|------------|--------|--------|---------------|--------|--------|------------|--------|--------|---------------|--------|--------|------|--------|--------|
| | | | Unit Price | | | Unit Price | | | Unit Price | | | Unit Price | | | Unit Price | | | | | |
| | | | Day | | Night | Day | | Night | Day | | Night | Day | | Night | Day | | Night | | | |
| Sum | Air | Noise | Sum | Air | Noise | Sum | Air | Noise | Sum | Air | Noise | Sum | Air | Noise | Sum | Air | Noise | | | |
| A01- | Wien Auhof | Preßbaum | 2,48 | 0,0000 | 0,0098 | 2,49 | 0,0000 | 0,0153 | 3,48 | 0,0000 | 0,0224 | 3,49 | 0,0000 | 0,0352 | 5,21 | 0,0000 | 0,0283 | 5,23 | 0,0000 | 0,0444 |
| A01- | Preßbaum | KN Steinhäusl | 1,40 | 0,0000 | 0,0055 | 1,40 | 0,0000 | 0,0087 | 1,97 | 0,0000 | 0,0127 | 1,97 | 0,0000 | 0,0199 | 2,95 | 0,0000 | 0,0160 | 2,96 | 0,0000 | 0,0251 |
| A01- | KN Steinhäusl | Altengbach | 0,82 | 0,0000 | 0,0032 | 0,83 | 0,0000 | 0,0051 | 1,16 | 0,0000 | 0,0075 | 1,16 | 0,0000 | 0,0117 | 1,73 | 0,0000 | 0,0094 | 1,74 | 0,0000 | 0,0148 |
| A01- | Altengbach | St. Christoph | 0,98 | 0,0000 | 0,0039 | 0,98 | 0,0000 | 0,0061 | 1,38 | 0,0000 | 0,0089 | 1,38 | 0,0000 | 0,0140 | 2,07 | 0,0000 | 0,0112 | 2,07 | 0,0000 | 0,0176 |
| A01- | St. Christoph | Böheimkirchen | 1,18 | 0,0000 | 0,0046 | 1,18 | 0,0000 | 0,0073 | 1,65 | 0,0000 | 0,0107 | 1,66 | 0,0000 | 0,0167 | 2,48 | 0,0000 | 0,0134 | 2,49 | 0,0000 | 0,0211 |
| A01- | Böheimkirchen | KN St. Pölten | 1,15 | 0,0000 | 0,0045 | 1,16 | 0,0000 | 0,0071 | 1,62 | 0,0000 | 0,0104 | 1,62 | 0,0000 | 0,0164 | 2,42 | 0,0000 | 0,0131 | 2,43 | 0,0000 | 0,0207 |
| A01- | KN St. Pölten | St. Pölten Süd | 0,82 | 0,0000 | 0,0032 | 0,82 | 0,0000 | 0,0051 | 1,15 | 0,0000 | 0,0074 | 1,15 | 0,0000 | 0,0116 | 1,72 | 0,0000 | 0,0093 | 1,72 | 0,0000 | 0,0147 |
| A01- | St. Pölten Süd | Loosdorf | 2,84 | 0,0000 | 0,0111 | 2,84 | 0,0000 | 0,0175 | 3,98 | 0,0000 | 0,0256 | 3,99 | 0,0000 | 0,0403 | 5,96 | 0,0000 | 0,0323 | 5,98 | 0,0000 | 0,0508 |
| A01- | Loosdorf | Melk | 1,04 | 0,0000 | 0,0041 | 1,04 | 0,0000 | 0,0064 | 1,46 | 0,0000 | 0,0094 | 1,46 | 0,0000 | 0,0148 | 2,18 | 0,0000 | 0,0118 | 2,19 | 0,0000 | 0,0186 |
| A01- | Melk | Pöchlarn | 1,84 | 0,0000 | 0,0072 | 1,85 | 0,0000 | 0,0114 | 2,58 | 0,0000 | 0,0167 | 2,59 | 0,0000 | 0,0262 | 3,87 | 0,0000 | 0,0210 | 3,89 | 0,0000 | 0,0330 |
| A01- | Pöchlarn | Ybbs Wieselburg | 1,70 | 0,0000 | 0,0067 | 1,70 | 0,0000 | 0,0105 | 2,39 | 0,0000 | 0,0154 | 2,39 | 0,0000 | 0,0242 | 3,57 | 0,0000 | 0,0194 | 3,59 | 0,0000 | 0,0305 |
| A01- | Ybbs Wieselburg | Amstetten Ost | 1,53 | 0,0000 | 0,0060 | 1,53 | 0,0000 | 0,0094 | 2,14 | 0,0000 | 0,0138 | 2,15 | 0,0000 | 0,0217 | 3,21 | 0,0000 | 0,0174 | 3,22 | 0,0000 | 0,0274 |
| A01- | Amstetten Ost | Amstetten West | 2,40 | 0,0000 | 0,0094 | 2,41 | 0,0000 | 0,0148 | 3,37 | 0,0000 | 0,0217 | 3,38 | 0,0000 | 0,0341 | 5,05 | 0,0000 | 0,0274 | 5,07 | 0,0000 | 0,0430 |
| A01- | Amstetten West | Oed | 1,69 | 0,0000 | 0,0066 | 1,69 | 0,0000 | 0,0104 | 2,37 | 0,0000 | 0,0153 | 2,38 | 0,0000 | 0,0240 | 3,55 | 0,0000 | 0,0192 | 3,56 | 0,0000 | 0,0302 |
| A01- | Oed | Haag | 1,82 | 0,0000 | 0,0072 | 1,82 | 0,0000 | 0,0112 | 2,55 | 0,0000 | 0,0165 | 2,56 | 0,0000 | 0,0259 | 3,83 | 0,0000 | 0,0208 | 3,84 | 0,0000 | 0,0326 |
| A01- | Haag | St. Valentin | 1,62 | 0,0000 | 0,0064 | 1,62 | 0,0000 | 0,0100 | 2,27 | 0,0000 | 0,0147 | 2,28 | 0,0000 | 0,0230 | 3,41 | 0,0000 | 0,0185 | 3,42 | 0,0000 | 0,0290 |
| A01- | St. Valentin | Enns Steyr | 0,69 | 0,0000 | 0,0027 | 0,69 | 0,0000 | 0,0042 | 0,96 | 0,0000 | 0,0062 | 0,97 | 0,0000 | 0,0098 | 1,45 | 0,0000 | 0,0078 | 1,45 | 0,0000 | 0,0123 |
| A01- | Enns Steyr | Enns West | 0,53 | 0,0000 | 0,0021 | 0,53 | 0,0000 | 0,0033 | 0,75 | 0,0000 | 0,0048 | 0,75 | 0,0000 | 0,0076 | 1,12 | 0,0000 | 0,0061 | 1,12 | 0,0000 | 0,0096 |
| A01- | Enns West | Asten St Florian | 0,41 | 0,0000 | 0,0016 | 0,41 | 0,0000 | 0,0026 | 0,58 | 0,0000 | 0,0037 | 0,58 | 0,0000 | 0,0059 | 0,87 | 0,0000 | 0,0047 | 0,87 | 0,0000 | 0,0074 |
| A01- | Asten St Florian | KN Linz | 1,58 | 0,0000 | 0,0062 | 1,59 | 0,0000 | 0,0098 | 2,22 | 0,0000 | 0,0143 | 2,23 | 0,0000 | 0,0225 | 3,33 | 0,0000 | 0,0181 | 3,34 | 0,0000 | 0,0284 |
| A01- | KN Linz | Ansfelden | 0,27 | 0,0000 | 0,0011 | 0,27 | 0,0000 | 0,0017 | 0,38 | 0,0000 | 0,0024 | 0,38 | 0,0000 | 0,0038 | 0,56 | 0,0000 | 0,0030 | 0,56 | 0,0000 | 0,0048 |
| A01- | Ansfelden | Traun | 0,59 | 0,0000 | 0,0023 | 0,59 | 0,0000 | 0,0037 | 0,83 | 0,0000 | 0,0053 | 0,83 | 0,0000 | 0,0084 | 1,24 | 0,0000 | 0,0067 | 1,25 | 0,0000 | 0,0106 |
| A01- | Traun | KN A1/A25 Passau Wels | 0,28 | 0,0000 | 0,0011 | 0,28 | 0,0000 | 0,0017 | 0,39 | 0,0000 | 0,0025 | 0,39 | 0,0000 | 0,0040 | 0,58 | 0,0000 | 0,0032 | 0,59 | 0,0000 | 0,0050 |
| A01- | KN A1/A25 Passau Wels | Allhaming | 1,28 | 0,0000 | 0,0050 | 1,29 | 0,0000 | 0,0079 | 1,80 | 0,0000 | 0,0116 | 1,81 | 0,0000 | 0,0182 | 2,70 | 0,0000 | 0,0146 | 2,71 | 0,0000 | 0,0230 |
| A01- | Allhaming | Sattledt | 2,14 | 0,0000 | 0,0084 | 2,15 | 0,0000 | 0,0132 | 3,00 | 0,0000 | 0,0194 | 3,02 | 0,0000 | 0,0304 | 4,50 | 0,0000 | 0,0244 | 4,52 | 0,0000 | 0,0384 |
| A01- | Sattledt | KN Voralpenkreuz | 0,27 | 0,0000 | 0,0011 | 0,27 | 0,0000 | 0,0017 | 0,38 | 0,0000 | 0,0024 | 0,38 | 0,0000 | 0,0038 | 0,57 | 0,0000 | 0,0031 | 0,57 | 0,0000 | 0,0048 |
| A01- | KN Voralpenkreuz | Eberstalzell | 0,77 | 0,0000 | 0,0030 | 0,78 | 0,0000 | 0,0048 | 1,09 | 0,0000 | 0,0070 | 1,09 | 0,0000 | 0,0110 | 1,63 | 0,0000 | 0,0088 | 1,63 | 0,0000 | 0,0139 |
| A01- | Eberstalzell | Vorchdorf | 1,17 | 0,0000 | 0,0046 | 1,17 | 0,0000 | 0,0072 | 1,64 | 0,0000 | 0,0106 | 1,65 | 0,0000 | 0,0166 | 2,46 | 0,0000 | 0,0133 | 2,46 | 0,0000 | 0,0209 |
| A01- | Vorchdorf | Laakirchen Ost | 1,02 | 0,0000 | 0,0040 | 1,03 | 0,0000 | 0,0063 | 1,44 | 0,0000 | 0,0093 | 1,44 | 0,0000 | 0,0146 | 2,15 | 0,0000 | 0,0117 | 2,16 | 0,0000 | 0,0183 |
| A01- | Laakirchen Ost | Laakirchen West | 0,64 | 0,0000 | 0,0025 | 0,65 | 0,0000 | 0,0040 | 0,90 | 0,0000 | 0,0058 | 0,91 | 0,0000 | 0,0092 | 1,36 | 0,0000 | 0,0073 | 1,36 | 0,0000 | 0,0115 |
| A01- | Laakirchen West | Regau | 1,26 | 0,0000 | 0,0050 | 1,27 | 0,0000 | 0,0078 | 1,77 | 0,0000 | 0,0114 | 1,78 | 0,0000 | 0,0180 | 2,66 | 0,0000 | 0,0144 | 2,66 | 0,0000 | 0,0226 |
| A01- | Regau | Schörfling | 1,66 | 0,0000 | 0,0065 | 1,66 | 0,0000 | 0,0103 | 2,33 | 0,0000 | 0,0150 | 2,34 | 0,0000 | 0,0236 | 3,49 | 0,0000 | 0,0189 | 3,50 | 0,0000 | 0,0297 |
| A01- | Schörfling | Seewalchen | 0,26 | 0,0000 | 0,0010 | 0,26 | 0,0000 | 0,0016 | 0,36 | 0,0000 | 0,0023 | 0,36 | 0,0000 | 0,0037 | 0,54 | 0,0000 | 0,0029 | 0,54 | 0,0000 | 0,0046 |
| A01- | Seewalchen | St. Georgen | 1,50 | 0,0000 | 0,0059 | 1,51 | 0,0000 | 0,0093 | 2,11 | 0,0000 | 0,0136 | 2,12 | 0,0000 | 0,0214 | 3,16 | 0,0000 | 0,0172 | 3,17 | 0,0000 | 0,0270 |
| A01- | St. Georgen | Oberwang | 2,01 | 0,0000 | 0,0079 | 2,01 | 0,0000 | 0,0124 | 2,82 | 0,0000 | 0,0181 | 2,83 | 0,0000 | 0,0285 | 4,22 | 0,0000 | 0,0229 | 4,23 | 0,0000 | 0,0360 |
| A01- | Oberwang | Mondsee | 1,85 | 0,0000 | 0,0073 | 1,85 | 0,0000 | 0,0114 | 2,59 | 0,0000 | 0,0167 | 2,60 | 0,0000 | 0,0262 | 3,88 | 0,0000 | 0,0211 | 3,90 | 0,0000 | 0,0331 |
| A01- | Mondsee | Thalgau | 1,70 | 0,0000 | 0,0067 | 1,71 | 0,0000 | 0,0105 | 2,39 | 0,0000 | 0,0154 | 2,40 | 0,0000 | 0,0242 | 3,58 | 0,0000 | 0,0194 | 3,59 | 0,0000 | 0,0305 |
| A01- | Thalgau | Wallersee | 1,30 | 0,0000 | 0,0051 | 1,30 | 0,0000 | 0,0080 | 1,82 | 0,0000 | 0,0117 | 1,83 | 0,0000 | 0,0184 | 2,73 | 0,0000 | 0,0148 | 2,74 | 0,0000 | 0,0232 |
| A01- | Wallersee | Salzburg Nord | 1,26 | 0,0000 | 0,0049 | 1,26 | 0,0000 | 0,0078 | 1,76 | 0,0000 | 0,0114 | 1,77 | 0,0000 | 0,0178 | 2,64 | 0,0000 | 0,0143 | 2,65 | 0,0000 | 0,0225 |
| A01- | Salzburg Nord | Salzburg Bergheim-West | 0,28 | 0,0000 | 0,0011 | 0,28 | 0,0000 | 0,0017 | 0,40 | 0,0000 | 0,0026 | 0,40 | 0,0000 | 0,0040 | 0,60 | 0,0000 | 0,0032 | 0,60 | 0,0000 | 0,0051 |
| A01- | Salzburg Bergheim-West | Messe | 0,14 | 0,0000 | 0,0005 | 0,14 | 0,0000 | 0,0008 | 0,19 | 0,0000 | 0,0012 | 0,19 | 0,0000 | 0,0019 | 0,28 | 0,0000 | 0,0015 | 0,29 | 0,0000 | 0,0024 |
| A01- | Messe | Salzburg Mitte Freilassing | 0,18 | 0,0000 | 0,0007 | 0,18 | 0,0000 | 0,0011 | 0,25 | 0,0000 | 0,0016 | 0,25 | 0,0000 | 0,0026 | 0,38 | 0,0000 | 0,0021 | 0,38 | 0,0000 | 0,0032 |
| A01- | Salzburg Mitte Freilassing | Kleßheim | 0,22 | 0,0000 | 0,0009 | 0,22 | 0,0000 | 0,0014 | 0,31 | 0,0000 | 0,0020 | 0,31 | 0,0000 | 0,0031 | 0,47 | 0,0000 | 0,0025 | 0,47 | 0,0000 | 0,0040 |
| A01- | Kleßheim | Siezenheim | 0,31 | 0,0000 | 0,0012 | 0,31 | 0,0000 | 0,0019 | 0,43 | 0,0000 | 0,0028 | 0,43 | 0,0000 | 0,0044 | 0,65 | 0,0000 | 0,0035 | 0,65 | 0,0000 | 0,0055 |
| A01- | Siezenheim | Flughafen | 0,15 | 0,0000 | 0,0006 | 0,15 | 0,0000 | 0,0010 | 0,22 | 0,0000 | 0,0014 | 0,22 | 0,0000 | 0,0022 | 0,32 | 0,0000 | 0,0018 | 0,33 | 0,0000 | 0,0028 |
| A01- | Flughafen | Wals Salzburg West | 0,19 | 0,0000 | 0,0007 | 0,19 | 0,0000 | 0,0012 | 0,26 | 0,0000 | 0,0017 | 0,27 | 0,0000 | 0,0027 | 0,40 | 0,0000 | 0,0021 | 0,40 | 0,0000 | 0,0034 |
| A01- | Wals Salzburg West | KN Salzburg | 0,28 | 0,0000 | 0,0011 | 0,28 | 0,0000 | 0,0017 | 0,40 | 0,0000 | 0,0026 | 0,40 | 0,0000 | 0,0040 | 0,59 | 0,0000 | 0,0032 | 0,60 | 0,0000 | 0,0051 |
| A01- | KN Salzburg | Staatsgrenze Walsberg | 0,48 | 0,0000 | 0,0019 | 0,48 | 0,0000 | 0,0030 | 0,67 | 0,0000 | 0,0043 | 0,68 | 0,0000 | 0,0068 | 1,01 | 0,0000 | 0,0055 | 1,01 | 0,0000 | 0,0086 |
| A02- | KN Wien Inzersdorf | KN Vösendorf | 0,60 | 0,0000 | 0,0024 | 0,60 | 0,0000 | 0,0037 | 0,84 | 0,0000 | 0,0054 | 0,85 | 0,0000 | 0,0085 | 1,26 | 0,0000 | 0,0068 | 1,27 | 0,0000 | 0,0108 |
| A02- | KN Vösendorf | Mödling | 0,41 | 0,0000 | 0,0016 | 0,41 | 0,0000 | 0,0025 | 0,57 | 0,0000 | 0,0037 | 0,57 | 0 | | | | | | | |

| | | | | | | | | | | | | | | | | | | | | |
|------|----------------------------|----------------------------|------|--------|--------|------|--------|--------|------|--------|--------|------|--------|--------|------|--------|--------|------|--------|--------|
| A02- | Ilz Fürstenfeld | Sinabelkirchen | 2,00 | 0,0000 | 0,0079 | 2,00 | 0,0000 | 0,0124 | 2,81 | 0,0000 | 0,0181 | 2,82 | 0,0000 | 0,0284 | 4,21 | 0,0000 | 0,0228 | 4,22 | 0,0000 | 0,0358 |
| A02- | Sinabelkirchen | Gleisdorf Süd | 1,32 | 0,0000 | 0,0052 | 1,32 | 0,0000 | 0,0081 | 1,85 | 0,0000 | 0,0119 | 1,86 | 0,0000 | 0,0187 | 2,77 | 0,0000 | 0,0150 | 2,78 | 0,0000 | 0,0236 |
| A02- | Gleisdorf Süd | Gleisdorf West | 0,57 | 0,0000 | 0,0022 | 0,57 | 0,0000 | 0,0035 | 0,80 | 0,0000 | 0,0052 | 0,81 | 0,0000 | 0,0081 | 1,20 | 0,0000 | 0,0065 | 1,21 | 0,0000 | 0,0102 |
| A02- | Gleisdorf West | Laßnitzhöhe | 1,50 | 0,0000 | 0,0059 | 1,50 | 0,0000 | 0,0093 | 2,10 | 0,0000 | 0,0135 | 2,11 | 0,0000 | 0,0213 | 3,15 | 0,0000 | 0,0171 | 3,16 | 0,0000 | 0,0268 |
| A02- | Laßnitzhöhe | KN Graz Ost | 1,87 | 0,0000 | 0,0074 | 1,88 | 0,0000 | 0,0116 | 2,63 | 0,0000 | 0,0170 | 2,64 | 0,0000 | 0,0266 | 3,94 | 0,0000 | 0,0214 | 3,95 | 0,0000 | 0,0336 |
| A02- | KN Graz Ost | Graz Feldkirchen Flughafen | 0,67 | 0,0000 | 0,0027 | 0,68 | 0,0000 | 0,0042 | 0,95 | 0,0000 | 0,0061 | 0,95 | 0,0000 | 0,0096 | 1,42 | 0,0000 | 0,0077 | 1,42 | 0,0000 | 0,0121 |
| A02- | Graz Feldkirchen Flughafen | KN Graz West | 0,45 | 0,0000 | 0,0018 | 0,45 | 0,0000 | 0,0028 | 0,63 | 0,0000 | 0,0041 | 0,64 | 0,0000 | 0,0064 | 0,95 | 0,0000 | 0,0051 | 0,95 | 0,0000 | 0,0081 |
| A02- | KN Graz West | Unterpremstätten | 0,54 | 0,0000 | 0,0021 | 0,54 | 0,0000 | 0,0034 | 0,76 | 0,0000 | 0,0049 | 0,76 | 0,0000 | 0,0077 | 1,14 | 0,0000 | 0,0062 | 1,14 | 0,0000 | 0,0097 |
| A02- | Unterpremstätten | Lieboch | 0,84 | 0,0000 | 0,0033 | 0,84 | 0,0000 | 0,0052 | 1,18 | 0,0000 | 0,0076 | 1,19 | 0,0000 | 0,0120 | 1,77 | 0,0000 | 0,0096 | 1,78 | 0,0000 | 0,0151 |
| A02- | Lieboch | Mooskirchen | 1,16 | 0,0000 | 0,0046 | 1,16 | 0,0000 | 0,0072 | 1,63 | 0,0000 | 0,0105 | 1,64 | 0,0000 | 0,0165 | 2,44 | 0,0000 | 0,0133 | 2,45 | 0,0000 | 0,0208 |
| A02- | Mooskirchen | Steinberg | 1,20 | 0,0000 | 0,0047 | 1,21 | 0,0000 | 0,0074 | 1,69 | 0,0000 | 0,0109 | 1,69 | 0,0000 | 0,0171 | 2,53 | 0,0000 | 0,0137 | 2,54 | 0,0000 | 0,0216 |
| A02- | Steinberg | Modriach | 3,01 | 0,0000 | 0,0118 | 3,01 | 0,0000 | 0,0186 | 4,22 | 0,0000 | 0,0272 | 4,24 | 0,0000 | 0,0427 | 6,32 | 0,0000 | 0,0343 | 6,34 | 0,0000 | 0,0539 |
| A022 | KN Graz Ost | Puchwerk | 0,13 | 0,0000 | 0,0005 | 0,13 | 0,0000 | 0,0008 | 0,18 | 0,0000 | 0,0011 | 0,18 | 0,0000 | 0,0018 | 0,27 | 0,0000 | 0,0014 | 0,27 | 0,0000 | 0,0023 |
| A022 | Puchwerk | Graz Raaba | 0,18 | 0,0000 | 0,0007 | 0,18 | 0,0000 | 0,0011 | 0,25 | 0,0000 | 0,0016 | 0,25 | 0,0000 | 0,0026 | 0,38 | 0,0000 | 0,0021 | 0,38 | 0,0000 | 0,0032 |
| A022 | Graz Raaba | Graz Sternäckerweg | 0,26 | 0,0000 | 0,0010 | 0,26 | 0,0000 | 0,0016 | 0,37 | 0,0000 | 0,0024 | 0,37 | 0,0000 | 0,0037 | 0,55 | 0,0000 | 0,0030 | 0,55 | 0,0000 | 0,0047 |
| A02- | Modriach | Packsattel | 1,38 | 0,0000 | 0,0054 | 1,39 | 0,0000 | 0,0086 | 1,94 | 0,0000 | 0,0125 | 1,95 | 0,0000 | 0,0197 | 2,91 | 0,0000 | 0,0158 | 2,92 | 0,0000 | 0,0248 |
| A02- | Packsattel | Bad St. Leonhard | 1,68 | 0,0000 | 0,0066 | 1,69 | 0,0000 | 0,0104 | 2,36 | 0,0000 | 0,0152 | 2,37 | 0,0000 | 0,0239 | 3,54 | 0,0000 | 0,0192 | 3,55 | 0,0000 | 0,0302 |
| A02- | Bad St. Leonhard | Wolfsberg Nord | 1,98 | 0,0000 | 0,0078 | 1,98 | 0,0000 | 0,0122 | 2,78 | 0,0000 | 0,0179 | 2,79 | 0,0000 | 0,0281 | 4,16 | 0,0000 | 0,0226 | 4,17 | 0,0000 | 0,0355 |
| A02- | Wolfsberg Nord | Wolfsberg Süd | 0,56 | 0,0000 | 0,0022 | 0,56 | 0,0000 | 0,0035 | 0,79 | 0,0000 | 0,0051 | 0,79 | 0,0000 | 0,0080 | 1,18 | 0,0000 | 0,0064 | 1,19 | 0,0000 | 0,0101 |
| A02- | Wolfsberg Süd | St. Andrä | 1,65 | 0,0000 | 0,0065 | 1,66 | 0,0000 | 0,0102 | 2,32 | 0,0000 | 0,0149 | 2,33 | 0,0000 | 0,0235 | 3,48 | 0,0000 | 0,0188 | 3,49 | 0,0000 | 0,0296 |
| A02- | St. Andrä | Griffen | 1,61 | 0,0000 | 0,0063 | 1,61 | 0,0000 | 0,0099 | 2,25 | 0,0000 | 0,0145 | 2,26 | 0,0000 | 0,0228 | 3,38 | 0,0000 | 0,0183 | 3,39 | 0,0000 | 0,0288 |
| A02- | Griffen | Völkermarkt Ost | 0,81 | 0,0000 | 0,0032 | 0,81 | 0,0000 | 0,0050 | 1,14 | 0,0000 | 0,0073 | 1,14 | 0,0000 | 0,0115 | 1,71 | 0,0000 | 0,0093 | 1,71 | 0,0000 | 0,0145 |
| A02- | Völkermarkt Ost | Völkermarkt West | 1,87 | 0,0000 | 0,0074 | 1,88 | 0,0000 | 0,0116 | 2,63 | 0,0000 | 0,0169 | 2,64 | 0,0000 | 0,0266 | 3,94 | 0,0000 | 0,0214 | 3,95 | 0,0000 | 0,0336 |
| A02- | Völkermarkt West | Grafenstein | 1,79 | 0,0000 | 0,0070 | 1,80 | 0,0000 | 0,0111 | 2,52 | 0,0000 | 0,0162 | 2,53 | 0,0000 | 0,0255 | 3,77 | 0,0000 | 0,0204 | 3,78 | 0,0000 | 0,0321 |
| A02- | Grafenstein | Klagenfurt Ost | 1,15 | 0,0000 | 0,0045 | 1,15 | 0,0000 | 0,0071 | 1,61 | 0,0000 | 0,0104 | 1,62 | 0,0000 | 0,0163 | 2,42 | 0,0000 | 0,0131 | 2,43 | 0,0000 | 0,0206 |
| A02- | Klagenfurt Ost | Klagenfurt Flughafen | 0,58 | 0,0000 | 0,0023 | 0,58 | 0,0000 | 0,0036 | 0,82 | 0,0000 | 0,0053 | 0,82 | 0,0000 | 0,0083 | 1,22 | 0,0000 | 0,0066 | 1,23 | 0,0000 | 0,0104 |
| A02- | Klagenfurt Flughafen | Klagenfurt Nord | 0,64 | 0,0000 | 0,0025 | 0,65 | 0,0000 | 0,0040 | 0,90 | 0,0000 | 0,0058 | 0,91 | 0,0000 | 0,0092 | 1,36 | 0,0000 | 0,0073 | 1,36 | 0,0000 | 0,0115 |
| A02- | Klagenfurt Nord | Klagenfurt West | 1,11 | 0,0000 | 0,0044 | 1,12 | 0,0000 | 0,0069 | 1,56 | 0,0000 | 0,0101 | 1,57 | 0,0000 | 0,0158 | 2,34 | 0,0000 | 0,0127 | 2,35 | 0,0000 | 0,0200 |
| A02- | Klagenfurt West | Krumpendorf West | 0,44 | 0,0000 | 0,0017 | 0,45 | 0,0000 | 0,0027 | 0,62 | 0,0000 | 0,0040 | 0,63 | 0,0000 | 0,0063 | 0,93 | 0,0000 | 0,0051 | 0,94 | 0,0000 | 0,0080 |
| A02- | Krumpendorf West | Pörschach Ost | 0,53 | 0,0000 | 0,0021 | 0,54 | 0,0000 | 0,0033 | 0,75 | 0,0000 | 0,0048 | 0,75 | 0,0000 | 0,0076 | 1,13 | 0,0000 | 0,0061 | 1,13 | 0,0000 | 0,0096 |
| A02- | Pörschach Ost | Pörschach West | 0,83 | 0,0000 | 0,0033 | 0,83 | 0,0000 | 0,0051 | 1,17 | 0,0000 | 0,0075 | 1,17 | 0,0000 | 0,0118 | 1,75 | 0,0000 | 0,0095 | 1,76 | 0,0000 | 0,0149 |
| A02- | Pörschach West | Velden Ost | 0,62 | 0,0000 | 0,0024 | 0,62 | 0,0000 | 0,0038 | 0,87 | 0,0000 | 0,0056 | 0,87 | 0,0000 | 0,0088 | 1,30 | 0,0000 | 0,0070 | 1,30 | 0,0000 | 0,0111 |
| A02- | Velden Ost | Velden West | 0,66 | 0,0000 | 0,0026 | 0,67 | 0,0000 | 0,0041 | 0,93 | 0,0000 | 0,0060 | 0,94 | 0,0000 | 0,0094 | 1,40 | 0,0000 | 0,0076 | 1,40 | 0,0000 | 0,0119 |
| A02- | Velden West | Wernberg | 1,10 | 0,0000 | 0,0043 | 1,10 | 0,0000 | 0,0068 | 1,54 | 0,0000 | 0,0099 | 1,55 | 0,0000 | 0,0156 | 2,31 | 0,0000 | 0,0125 | 2,32 | 0,0000 | 0,0197 |
| A02- | Wernberg | KN Villach | 0,58 | 0,0000 | 0,0023 | 0,59 | 0,0000 | 0,0036 | 0,82 | 0,0000 | 0,0053 | 0,82 | 0,0000 | 0,0083 | 1,23 | 0,0000 | 0,0067 | 1,23 | 0,0000 | 0,0105 |
| A02- | KN Villach | Villach Faaker See | 0,45 | 0,0000 | 0,0018 | 0,45 | 0,0000 | 0,0028 | 0,64 | 0,0000 | 0,0041 | 0,64 | 0,0000 | 0,0065 | 0,95 | 0,0000 | 0,0052 | 0,96 | 0,0000 | 0,0081 |
| A02- | Villach Faaker See | Villach Warmbad | 1,04 | 0,0000 | 0,0041 | 1,04 | 0,0000 | 0,0064 | 1,46 | 0,0000 | 0,0094 | 1,46 | 0,0000 | 0,0147 | 2,18 | 0,0000 | 0,0118 | 2,19 | 0,0000 | 0,0186 |
| A02- | Villach Warmbad | Hermagor | 1,88 | 0,0000 | 0,0074 | 1,88 | 0,0000 | 0,0116 | 2,64 | 0,0000 | 0,0170 | 2,65 | 0,0000 | 0,0267 | 3,95 | 0,0000 | 0,0214 | 3,97 | 0,0000 | 0,0337 |
| A02- | Hermagor | Arnoldstein | 0,45 | 0,0000 | 0,0018 | 0,45 | 0,0000 | 0,0028 | 0,63 | 0,0000 | 0,0040 | 0,63 | 0,0000 | 0,0064 | 0,94 | 0,0000 | 0,0051 | 0,94 | 0,0000 | 0,0080 |
| A02- | Arnoldstein | Staatsgrenze Arnoldstein | 0,69 | 0,0000 | 0,0027 | 0,69 | 0,0000 | 0,0042 | 0,96 | 0,0000 | 0,0062 | 0,97 | 0,0000 | 0,0098 | 1,44 | 0,0000 | 0,0078 | 1,45 | 0,0000 | 0,0123 |
| A03- | KN Guntramsdorf | Münchendorf/Achau | 0,18 | 0,0000 | 0,0007 | 0,18 | 0,0000 | 0,0011 | 0,25 | 0,0000 | 0,0016 | 0,25 | 0,0000 | 0,0025 | 0,37 | 0,0000 | 0,0020 | 0,38 | 0,0000 | 0,0032 |
| A03- | Münchendorf/Achau | Ebreichsdorf Nord | 0,75 | 0,0000 | 0,0029 | 0,75 | 0,0000 | 0,0046 | 1,05 | 0,0000 | 0,0068 | 1,06 | 0,0000 | 0,0107 | 1,58 | 0,0000 | 0,0086 | 1,58 | 0,0000 | 0,0134 |
| A03- | Ebreichsdorf Nord | Ebreichsdorf West | 0,61 | 0,0000 | 0,0024 | 0,61 | 0,0000 | 0,0038 | 0,86 | 0,0000 | 0,0055 | 0,86 | 0,0000 | 0,0087 | 1,29 | 0,0000 | 0,0070 | 1,29 | 0,0000 | 0,0110 |
| A03- | Ebreichsdorf West | Pottendorf | 0,80 | 0,0000 | 0,0032 | 0,81 | 0,0000 | 0,0050 | 1,13 | 0,0000 | 0,0073 | 1,13 | 0,0000 | 0,0114 | 1,69 | 0,0000 | 0,0092 | 1,69 | 0,0000 | 0,0144 |
| A03- | Pottendorf | Hornstein | 1,32 | 0,0000 | 0,0052 | 1,32 | 0,0000 | 0,0082 | 1,85 | 0,0000 | 0,0119 | 1,86 | 0,0000 | 0,0187 | 2,77 | 0,0000 | 0,0150 | 2,78 | 0,0000 | 0,0236 |
| A03- | Hornstein | Müllendorf | 0,86 | 0,0000 | 0,0034 | 0,87 | 0,0000 | 0,0053 | 1,21 | 0,0000 | 0,0078 | 1,22 | 0,0000 | 0,0123 | 1,82 | 0,0000 | 0,0099 | 1,82 | 0,0000 | 0,0155 |
| A03- | Müllendorf | KN Eisenstadt | 0,72 | 0,0000 | 0,0028 | 0,72 | 0,0000 | 0,0045 | 1,01 | 0,0000 | 0,0065 | 1,02 | 0,0000 | 0,0103 | 1,52 | 0,0000 | 0,0082 | 1,52 | 0,0000 | 0,0129 |
| A031 | KN Eisenstadt | Siegersdorf | 0,57 | 0,0000 | 0,0022 | 0,57 | 0,0000 | 0,0035 | 0,80 | 0,0000 | 0,0052 | 0,80 | 0,0000 | 0,0081 | 1,20 | 0,0000 | 0,0065 | 1,20 | 0,0000 | 0,0102 |
| A041 | Stadionbrücke | KN Wien Prater | 0,10 | 0,0000 | 0,0004 | 0,10 | 0,0000 | 0,0006 | 0,15 | 0,0000 | 0,0009 | 0,15 | 0,0000 | 0,0015 | 0,22 | 0,0000 | 0,0012 | 0,22 | 0,0000 | 0,0019 |
| A04- | KN Wien Prater | Alt-Simmering | 0,23 | 0,0000 | 0,0009 | 0,23 | 0,0000 | 0,0014 | 0,32 | 0,0000 | 0,0021 | 0,32 | 0,0000 | 0,0032 | 0,48 | 0,0000 | 0,0026 | 0,48 | 0,0000 | 0,0041 |
| A04- | Alt-Simmering | Wien 7. Haidequerstraße | 0,17 | 0,0000 | 0,0007 | 0,17 | 0,0000 | 0,0011 | 0,24 | 0,0000 | 0,0016 | 0,24 | 0,0000 | 0,0024 | 0,36 | 0,0000 | 0,0020 | 0,36 | 0,0000 | 0,0031 |
| A04- | Wien 7. Haidequerstraße | Wien Simmeringer Haide | 0,32 | 0,0000 | 0,0013 | 0,32 | 0,0000 | 0,0020 | 0,45 | 0,0000 | 0,0029 | 0,45 | 0,0000 | 0,0046 | 0,68 | 0,0000 | 0,0037 | 0,68 | 0,0000 | 0,0058 |
| A04- | Wien Simmeringer Haide | KN Schwechat | 0,65 | 0,0000 | 0,0025 | 0,65 | 0,0000 | 0,0040 | 0,91 | 0,0000 | 0,0059 | 0,91 | 0,0000 | 0,0092 | 1,36 | 0,0000 | 0,0074 | 1,37 | 0,0000 | 0,0116 |
| A04- | KN Schwechat | Flughafen Wien Schwechat | 0,94 | 0,0000 | 0,0037 | 0,94 | 0,0000 | 0,0058 | 1,31 | 0,0000 | 0,0085 | 1,32 | 0,0000 | 0,0133 | 1,97 | 0,0000 | 0,0107 | 1,97 | 0,0000 | 0,0168 |
| A04- | Flughafen Wien Schwechat | Fischamend | 1,05 | 0,0000 | 0,0041 | 1,05 | 0,0000 | 0,0065 | 1,47 | 0,0000 | 0,0095 | 1,48 | 0,0000 | 0,0149 | 2,20 | 0,0000 | 0,0120 | 2,21 | 0,0000 | 0,0188 |
| A04- | Fischamend | Bruck/Leitha West | 2,30 | 0,0000 | 0,0090 | 2,30 | 0,0000 | 0,0142 | 3,23 | 0,0000 | 0,0208 | 3,24 | 0,0000 | 0,0327 | 4,83 | 0,0000 | 0,0262 | 4,85 | 0,0000 | 0,0412 |
| A04- | Bruck/Leitha West | Bruck/Leitha Ost | 0,76 | 0,0000 | 0,0030 | 0,77 | 0,0000 | 0,0047 | 1,07 | 0,0000 | 0,0069 | 1, | | | | | | | | |

| | | | | | | | | | | | | | | | | | | | | |
|------|----------------------------------|----------------------------------|------|--------|--------|------|--------|--------|-------|--------|--------|-------|--------|--------|-------|--------|--------|-------|--------|--------|
| A05- | Großkrut | Poysdorf Nord | 1,22 | 0,0000 | 0,0048 | 1,22 | 0,0000 | 0,0075 | 1,71 | 0,0000 | 0,0110 | 1,72 | 0,0000 | 0,0173 | 2,57 | 0,0000 | 0,0139 | 2,57 | 0,0000 | 0,0219 |
| A06- | KN Bruckneudorf | Potzneusiedl | 1,55 | 0,0000 | 0,0061 | 1,55 | 0,0000 | 0,0095 | 2,17 | 0,0000 | 0,0140 | 2,18 | 0,0000 | 0,0220 | 3,25 | 0,0000 | 0,0176 | 3,26 | 0,0000 | 0,0277 |
| A06- | Potzneusiedl | Gattendorf | 0,67 | 0,0000 | 0,0026 | 0,67 | 0,0000 | 0,0041 | 0,94 | 0,0000 | 0,0061 | 0,94 | 0,0000 | 0,0095 | 1,41 | 0,0000 | 0,0076 | 1,41 | 0,0000 | 0,0120 |
| A06- | Gattendorf | Kittsee | 1,12 | 0,0000 | 0,0044 | 1,12 | 0,0000 | 0,0069 | 1,57 | 0,0000 | 0,0101 | 1,58 | 0,0000 | 0,0159 | 2,36 | 0,0000 | 0,0128 | 2,37 | 0,0000 | 0,0201 |
| A06- | Kittsee | Staatsgrenze Kittsee | 0,57 | 0,0000 | 0,0022 | 0,57 | 0,0000 | 0,0035 | 0,80 | 0,0000 | 0,0052 | 0,80 | 0,0000 | 0,0081 | 1,20 | 0,0000 | 0,0065 | 1,20 | 0,0000 | 0,0102 |
| A07- | KN Linz | Linz Franzosenhausweg | 0,40 | 0,0000 | 0,0016 | 0,40 | 0,0000 | 0,0025 | 0,56 | 0,0000 | 0,0036 | 0,57 | 0,0000 | 0,0057 | 0,85 | 0,0000 | 0,0046 | 0,85 | 0,0000 | 0,0072 |
| A07- | Linz Franzosenhausweg | Linz Salzburger Straße Neue Welt | 0,35 | 0,0000 | 0,0014 | 0,35 | 0,0000 | 0,0022 | 0,49 | 0,0000 | 0,0032 | 0,49 | 0,0000 | 0,0050 | 0,74 | 0,0000 | 0,0040 | 0,74 | 0,0000 | 0,0063 |
| A07- | Linz Salzburger Straße Neue Welt | Muldenstraße Bindermichl | 0,24 | 0,0000 | 0,0010 | 0,24 | 0,0000 | 0,0015 | 0,34 | 0,0000 | 0,0022 | 0,34 | 0,0000 | 0,0035 | 0,51 | 0,0000 | 0,0028 | 0,51 | 0,0000 | 0,0044 |
| A07- | Muldenstraße Bindermichl | Leonding Linz Zentrum | 0,12 | 0,0000 | 0,0005 | 0,12 | 0,0000 | 0,0007 | 0,17 | 0,0000 | 0,0011 | 0,17 | 0,0000 | 0,0017 | 0,25 | 0,0000 | 0,0013 | 0,25 | 0,0000 | 0,0021 |
| A07- | Leonding Linz Zentrum | Linz Wiener Straße | 0,17 | 0,0000 | 0,0007 | 0,17 | 0,0000 | 0,0010 | 0,23 | 0,0000 | 0,0015 | 0,23 | 0,0000 | 0,0024 | 0,35 | 0,0000 | 0,0019 | 0,35 | 0,0000 | 0,0030 |
| A07- | Linz Wiener Straße | Linz VOEST | 0,15 | 0,0000 | 0,0006 | 0,15 | 0,0000 | 0,0010 | 0,22 | 0,0000 | 0,0014 | 0,22 | 0,0000 | 0,0022 | 0,33 | 0,0000 | 0,0018 | 0,33 | 0,0000 | 0,0028 |
| A07- | Linz VOEST | Linz Industriezeile | 0,12 | 0,0000 | 0,0005 | 0,12 | 0,0000 | 0,0007 | 0,17 | 0,0000 | 0,0011 | 0,17 | 0,0000 | 0,0017 | 0,26 | 0,0000 | 0,0014 | 0,26 | 0,0000 | 0,0022 |
| A07- | Linz Industriezeile | Linz Prinz Eugenstraße | 0,19 | 0,0000 | 0,0008 | 0,19 | 0,0000 | 0,0012 | 0,27 | 0,0000 | 0,0017 | 0,27 | 0,0000 | 0,0027 | 0,40 | 0,0000 | 0,0022 | 0,41 | 0,0000 | 0,0034 |
| A07- | Linz Prinz Eugenstraße | Linz Hafenstraße | 0,36 | 0,0000 | 0,0014 | 0,36 | 0,0000 | 0,0022 | 0,51 | 0,0000 | 0,0033 | 0,51 | 0,0000 | 0,0051 | 0,76 | 0,0000 | 0,0041 | 0,76 | 0,0000 | 0,0065 |
| A07- | Linz Hafenstraße | Linz Urfa hr | 0,14 | 0,0000 | 0,0006 | 0,14 | 0,0000 | 0,0009 | 0,20 | 0,0000 | 0,0013 | 0,20 | 0,0000 | 0,0020 | 0,30 | 0,0000 | 0,0016 | 0,30 | 0,0000 | 0,0025 |
| A07- | Linz Urfa hr | Linz Dornach | 0,34 | 0,0000 | 0,0013 | 0,34 | 0,0000 | 0,0021 | 0,48 | 0,0000 | 0,0031 | 0,48 | 0,0000 | 0,0049 | 0,72 | 0,0000 | 0,0039 | 0,72 | 0,0000 | 0,0061 |
| A07- | Linz Dornach | Treffling | 0,75 | 0,0000 | 0,0030 | 0,76 | 0,0000 | 0,0047 | 1,06 | 0,0000 | 0,0068 | 1,06 | 0,0000 | 0,0107 | 1,59 | 0,0000 | 0,0086 | 1,59 | 0,0000 | 0,0135 |
| A07- | Treffling | Gallneukirchen | 0,57 | 0,0000 | 0,0022 | 0,57 | 0,0000 | 0,0035 | 0,80 | 0,0000 | 0,0051 | 0,80 | 0,0000 | 0,0081 | 1,19 | 0,0000 | 0,0065 | 1,20 | 0,0000 | 0,0102 |
| A07- | Gallneukirchen | Engerwitzdorf | 0,51 | 0,0000 | 0,0020 | 0,51 | 0,0000 | 0,0031 | 0,71 | 0,0000 | 0,0046 | 0,71 | 0,0000 | 0,0072 | 1,06 | 0,0000 | 0,0058 | 1,07 | 0,0000 | 0,0091 |
| A07- | Engerwitzdorf | Unterweikersdorf | 0,65 | 0,0000 | 0,0026 | 0,65 | 0,0000 | 0,0040 | 0,91 | 0,0000 | 0,0059 | 0,91 | 0,0000 | 0,0092 | 1,36 | 0,0000 | 0,0074 | 1,37 | 0,0000 | 0,0116 |
| A08- | KN Voralpenkreuz | Wels West | 1,99 | 0,0000 | 0,0078 | 1,99 | 0,0000 | 0,0123 | 2,79 | 0,0000 | 0,0180 | 2,80 | 0,0000 | 0,0283 | 4,18 | 0,0000 | 0,0227 | 4,20 | 0,0000 | 0,0357 |
| A08- | Wels West | KN Wels | 0,70 | 0,0000 | 0,0028 | 0,70 | 0,0000 | 0,0043 | 0,98 | 0,0000 | 0,0063 | 0,99 | 0,0000 | 0,0100 | 1,48 | 0,0000 | 0,0080 | 1,48 | 0,0000 | 0,0126 |
| A08- | KN Wels | Pichl/Bad Schallerbach | 0,77 | 0,0000 | 0,0030 | 0,77 | 0,0000 | 0,0048 | 1,08 | 0,0000 | 0,0070 | 1,09 | 0,0000 | 0,0110 | 1,62 | 0,0000 | 0,0088 | 1,63 | 0,0000 | 0,0138 |
| A08- | Pichl/Bad Schallerbach | Meggenhofen Gallspace | 1,95 | 0,0000 | 0,0077 | 1,96 | 0,0000 | 0,0121 | 2,74 | 0,0000 | 0,0176 | 2,75 | 0,0000 | 0,0277 | 4,10 | 0,0000 | 0,0223 | 4,12 | 0,0000 | 0,0350 |
| A08- | Meggenhofen Gallspace | Haag am Hausruck | 2,13 | 0,0000 | 0,0084 | 2,13 | 0,0000 | 0,0131 | 2,98 | 0,0000 | 0,0192 | 3,00 | 0,0000 | 0,0302 | 4,47 | 0,0000 | 0,0243 | 4,49 | 0,0000 | 0,0381 |
| A08- | Haag am Hausruck | Ried im Innkreis | 1,94 | 0,0000 | 0,0076 | 1,94 | 0,0000 | 0,0120 | 2,72 | 0,0000 | 0,0176 | 2,73 | 0,0000 | 0,0276 | 4,08 | 0,0000 | 0,0221 | 4,09 | 0,0000 | 0,0348 |
| A08- | Ried im Innkreis | Ort im Innkreis | 2,08 | 0,0000 | 0,0082 | 2,09 | 0,0000 | 0,0129 | 2,92 | 0,0000 | 0,0188 | 2,93 | 0,0000 | 0,0296 | 4,38 | 0,0000 | 0,0238 | 4,39 | 0,0000 | 0,0373 |
| A08- | Ort im Innkreis | Schärding Suben | 1,57 | 0,0000 | 0,0062 | 1,58 | 0,0000 | 0,0097 | 2,21 | 0,0000 | 0,0142 | 2,21 | 0,0000 | 0,0223 | 3,31 | 0,0000 | 0,0179 | 3,32 | 0,0000 | 0,0282 |
| A08- | Schärding Suben | Staatsgrenze Suben | 0,40 | 0,0000 | 0,0016 | 0,40 | 0,0000 | 0,0025 | 0,56 | 0,0000 | 0,0036 | 0,56 | 0,0000 | 0,0056 | 0,84 | 0,0000 | 0,0045 | 0,84 | 0,0000 | 0,0071 |
| A09- | KN Voralpenkreuz | Ried im Traunkreis | 0,98 | 0,0000 | 0,0039 | 0,98 | 0,0000 | 0,0061 | 1,37 | 0,0000 | 0,0089 | 1,38 | 0,0000 | 0,0139 | 2,06 | 0,0000 | 0,0112 | 2,07 | 0,0000 | 0,0175 |
| A09- | Ried im Traunkreis | Inzersdorf Kirchdorf | 1,84 | 0,0000 | 0,0072 | 1,84 | 0,0000 | 0,0114 | 2,58 | 0,0000 | 0,0166 | 2,59 | 0,0000 | 0,0261 | 3,86 | 0,0000 | 0,0209 | 3,88 | 0,0000 | 0,0329 |
| A09- | Inzersdorf Kirchdorf | Klaus | 2,24 | 0,0000 | 0,0088 | 2,24 | 0,0000 | 0,0138 | 3,14 | 0,0000 | 0,0202 | 3,15 | 0,0000 | 0,0318 | 4,71 | 0,0000 | 0,0255 | 4,72 | 0,0000 | 0,0401 |
| A09- | Klaus | St. Pankratz | 1,42 | 0,0000 | 0,0056 | 1,43 | 0,0000 | 0,0088 | 2,00 | 0,0000 | 0,0129 | 2,00 | 0,0000 | 0,0202 | 2,99 | 0,0000 | 0,0162 | 3,00 | 0,0000 | 0,0255 |
| A09- | St. Pankratz | Roßleiten Windischgarsten | 1,98 | 0,0000 | 0,0078 | 1,99 | 0,0000 | 0,0123 | 2,79 | 0,0000 | 0,0179 | 2,80 | 0,0000 | 0,0282 | 4,17 | 0,0000 | 0,0226 | 4,19 | 0,0000 | 0,0356 |
| A09- | Roßleiten Windischgarsten | Gleinkerau | 0,93 | 0,0000 | 0,0037 | 0,93 | 0,0000 | 0,0058 | 1,31 | 0,0000 | 0,0084 | 1,31 | 0,0000 | 0,0133 | 1,96 | 0,0000 | 0,0106 | 1,97 | 0,0000 | 0,0167 |
| A09- | Gleinkerau | Spital am Pyhrn | 0,70 | 0,0000 | 0,0028 | 0,70 | 0,0000 | 0,0043 | 0,99 | 0,0000 | 0,0064 | 0,99 | 0,0000 | 0,0100 | 1,48 | 0,0000 | 0,0080 | 1,48 | 0,0000 | 0,0126 |
| A09- | Spital am Pyhrn | Ardning / Admont | 4,02 | 0,0000 | 0,0070 | 4,02 | 0,0000 | 0,0111 | 5,63 | 0,0000 | 0,0162 | 5,64 | 0,0000 | 0,0254 | 8,45 | 0,0000 | 0,0204 | 8,46 | 0,0000 | 0,0321 |
| A09- | Ardning / Admont | Liezen | 0,41 | 0,0000 | 0,0016 | 0,41 | 0,0000 | 0,0025 | 0,57 | 0,0000 | 0,0037 | 0,57 | 0,0000 | 0,0058 | 0,86 | 0,0000 | 0,0047 | 0,86 | 0,0000 | 0,0073 |
| A09- | Liezen | Rottenmann | 0,85 | 0,0000 | 0,0034 | 0,85 | 0,0000 | 0,0053 | 1,20 | 0,0000 | 0,0077 | 1,20 | 0,0000 | 0,0121 | 1,79 | 0,0000 | 0,0097 | 1,80 | 0,0000 | 0,0153 |
| A09- | Rottenmann | Trieben | 2,13 | 0,0000 | 0,0084 | 2,13 | 0,0000 | 0,0131 | 2,98 | 0,0000 | 0,0192 | 2,99 | 0,0000 | 0,0302 | 4,47 | 0,0000 | 0,0242 | 4,48 | 0,0000 | 0,0381 |
| A09- | Trieben | Treglwang | 1,73 | 0,0000 | 0,0068 | 1,73 | 0,0000 | 0,0107 | 2,43 | 0,0000 | 0,0156 | 2,43 | 0,0000 | 0,0246 | 3,63 | 0,0000 | 0,0197 | 3,65 | 0,0000 | 0,0310 |
| A09- | Treglwang | Kalwang | 2,32 | 0,0000 | 0,0091 | 2,33 | 0,0000 | 0,0143 | 3,26 | 0,0000 | 0,0210 | 3,27 | 0,0000 | 0,0330 | 4,88 | 0,0000 | 0,0265 | 4,90 | 0,0000 | 0,0416 |
| A09- | Kalwang | Mautern | 1,08 | 0,0000 | 0,0043 | 1,08 | 0,0000 | 0,0067 | 1,52 | 0,0000 | 0,0098 | 1,52 | 0,0000 | 0,0154 | 2,27 | 0,0000 | 0,0123 | 2,28 | 0,0000 | 0,0194 |
| A09- | Mautern | Kammern | 1,22 | 0,0000 | 0,0048 | 1,22 | 0,0000 | 0,0075 | 1,71 | 0,0000 | 0,0110 | 1,71 | 0,0000 | 0,0173 | 2,56 | 0,0000 | 0,0139 | 2,57 | 0,0000 | 0,0218 |
| A09- | Kammern | Traboch | 1,27 | 0,0000 | 0,0050 | 1,27 | 0,0000 | 0,0079 | 1,78 | 0,0000 | 0,0115 | 1,79 | 0,0000 | 0,0181 | 2,67 | 0,0000 | 0,0145 | 2,68 | 0,0000 | 0,0228 |
| A09- | Traboch | Terminal St. Michael | 0,25 | 0,0000 | 0,0010 | 0,25 | 0,0000 | 0,0015 | 0,35 | 0,0000 | 0,0023 | 0,35 | 0,0000 | 0,0035 | 0,53 | 0,0000 | 0,0028 | 0,53 | 0,0000 | 0,0045 |
| A09- | Terminal St. Michael | KN St. Michael | 0,47 | 0,0000 | 0,0018 | 0,47 | 0,0000 | 0,0029 | 0,66 | 0,0000 | 0,0042 | 0,66 | 0,0000 | 0,0067 | 0,98 | 0,0000 | 0,0053 | 0,99 | 0,0000 | 0,0084 |
| A09- | KN St. Michael | Übelbach | 9,79 | 0,0000 | 0,0171 | 9,80 | 0,0000 | 0,0269 | 13,72 | 0,0000 | 0,0394 | 13,75 | 0,0000 | 0,0620 | 20,58 | 0,0000 | 0,0497 | 20,61 | 0,0000 | 0,0781 |
| A09- | Übelbach | KN Peggau Deutschfeistritz | 1,44 | 0,0000 | 0,0057 | 1,45 | 0,0000 | 0,0089 | 2,02 | 0,0000 | 0,0130 | 2,03 | 0,0000 | 0,0205 | 3,03 | 0,0000 | 0,0164 | 3,04 | 0,0000 | 0,0258 |
| A09- | KN Peggau Deutschfeistritz | Gratkorn Nord | 0,68 | 0,0000 | 0,0027 | 0,68 | 0,0000 | 0,0042 | 0,96 | 0,0000 | 0,0062 | 0,96 | 0,0000 | 0,0097 | 1,44 | 0,0000 | 0,0078 | 1,44 | 0,0000 | 0,0122 |
| A09- | Gratkorn Nord | Gratkorn Süd | 0,75 | 0,0000 | 0,0030 | 0,75 | 0,0000 | 0,0046 | 1,05 | 0,0000 | 0,0068 | 1,06 | 0,0000 | 0,0107 | 1,58 | 0,0000 | 0,0086 | 1,58 | 0,0000 | 0, |

| | | | | | | | | | | | | | | | | | | | | |
|------|--|---|-------|--------|--------|-------|--------|--------|-------|--------|--------|-------|--------|--------|-------|--------|--------|-------|--------|--------|
| A10- | Hallein | Kuchl | 1,04 | 0,0000 | 0,0041 | 1,04 | 0,0000 | 0,0064 | 1,46 | 0,0000 | 0,0094 | 1,47 | 0,0000 | 0,0148 | 2,19 | 0,0000 | 0,0119 | 2,20 | 0,0000 | 0,0187 |
| A10- | Kuchl | Golling / Abtenau | 1,05 | 0,0000 | 0,0041 | 1,05 | 0,0000 | 0,0065 | 1,47 | 0,0000 | 0,0095 | 1,48 | 0,0000 | 0,0149 | 2,20 | 0,0000 | 0,0119 | 2,21 | 0,0000 | 0,0188 |
| A10- | Golling / Abtenau | Paß Lueg | 1,09 | 0,0000 | 0,0043 | 1,10 | 0,0000 | 0,0068 | 1,53 | 0,0000 | 0,0099 | 1,54 | 0,0000 | 0,0155 | 2,30 | 0,0000 | 0,0125 | 2,31 | 0,0000 | 0,0196 |
| A10- | Paß Lueg | Werfen | 1,56 | 0,0000 | 0,0061 | 1,56 | 0,0000 | 0,0096 | 2,19 | 0,0000 | 0,0141 | 2,19 | 0,0000 | 0,0221 | 3,27 | 0,0000 | 0,0178 | 3,28 | 0,0000 | 0,0279 |
| A10- | Werfen | Pfarrwerfen / Werfen | 0,20 | 0,0000 | 0,0008 | 0,20 | 0,0000 | 0,0013 | 0,28 | 0,0000 | 0,0018 | 0,29 | 0,0000 | 0,0029 | 0,43 | 0,0000 | 0,0023 | 0,43 | 0,0000 | 0,0036 |
| A10- | Pfarrwerfen / Werfen | KN Pongau | 0,44 | 0,0000 | 0,0017 | 0,44 | 0,0000 | 0,0027 | 0,62 | 0,0000 | 0,0040 | 0,62 | 0,0000 | 0,0063 | 0,93 | 0,0000 | 0,0050 | 0,93 | 0,0000 | 0,0079 |
| A101 | KN Pongau | Bischofshofen Mühlbach a. Hochkönig | 0,66 | 0,0000 | 0,0026 | 0,66 | 0,0000 | 0,0040 | 0,92 | 0,0000 | 0,0059 | 0,92 | 0,0000 | 0,0093 | 1,38 | 0,0000 | 0,0075 | 1,38 | 0,0000 | 0,0117 |
| A10- | KN Pongau | Lammertal Hütttau | 1,79 | 0,0000 | 0,0070 | 1,80 | 0,0000 | 0,0111 | 2,51 | 0,0000 | 0,0162 | 2,52 | 0,0000 | 0,0255 | 3,77 | 0,0000 | 0,0204 | 3,78 | 0,0000 | 0,0321 |
| A10- | Lammertal Hütttau | F. Verbindung GH Eben | 0,46 | 0,0000 | 0,0018 | 0,46 | 0,0000 | 0,0028 | 0,65 | 0,0000 | 0,0042 | 0,65 | 0,0000 | 0,0066 | 0,97 | 0,0000 | 0,0053 | 0,97 | 0,0000 | 0,0083 |
| A10- | F. Verbindung GH Eben | Eben | 0,21 | 0,0000 | 0,0008 | 0,21 | 0,0000 | 0,0013 | 0,30 | 0,0000 | 0,0019 | 0,30 | 0,0000 | 0,0030 | 0,45 | 0,0000 | 0,0024 | 0,45 | 0,0000 | 0,0038 |
| A10- | Eben | Radstadt Altenmarkt Graz | 0,47 | 0,0000 | 0,0019 | 0,48 | 0,0000 | 0,0029 | 0,67 | 0,0000 | 0,0043 | 0,67 | 0,0000 | 0,0067 | 1,00 | 0,0000 | 0,0054 | 1,00 | 0,0000 | 0,0085 |
| A10- | Radstadt Altenmarkt Graz | Flachau | 0,66 | 0,0000 | 0,0026 | 0,66 | 0,0000 | 0,0041 | 0,93 | 0,0000 | 0,0060 | 0,93 | 0,0000 | 0,0094 | 1,40 | 0,0000 | 0,0076 | 1,40 | 0,0000 | 0,0119 |
| A10- | Flachau | Flachauwinkel | 2,68 | 0,0000 | 0,0051 | 2,69 | 0,0000 | 0,0080 | 3,76 | 0,0000 | 0,0117 | 3,77 | 0,0000 | 0,0184 | 5,64 | 0,0000 | 0,0148 | 5,65 | 0,0000 | 0,0232 |
| A10- | Flachauwinkel | Zederhaus | 6,77 | 0,0000 | 0,0128 | 6,77 | 0,0000 | 0,0202 | 9,48 | 0,0000 | 0,0295 | 9,50 | 0,0000 | 0,0464 | 14,22 | 0,0000 | 0,0372 | 14,24 | 0,0000 | 0,0584 |
| A10- | Zederhaus | St. Michael/Lungau | 4,46 | 0,0000 | 0,0085 | 4,47 | 0,0000 | 0,0133 | 6,26 | 0,0000 | 0,0195 | 6,27 | 0,0000 | 0,0306 | 9,38 | 0,0000 | 0,0245 | 9,40 | 0,0000 | 0,0386 |
| A10- | St. Michael/Lungau | Rennweg Katschberg | 3,27 | 0,0000 | 0,0062 | 3,28 | 0,0000 | 0,0097 | 4,59 | 0,0000 | 0,0143 | 4,60 | 0,0000 | 0,0224 | 6,88 | 0,0000 | 0,0180 | 6,89 | 0,0000 | 0,0283 |
| A102 | Seeboden | KN Spittal Millstätter See | 0,35 | 0,0000 | 0,0014 | 0,35 | 0,0000 | 0,0021 | 0,48 | 0,0000 | 0,0031 | 0,49 | 0,0000 | 0,0049 | 0,73 | 0,0000 | 0,0039 | 0,73 | 0,0000 | 0,0062 |
| A102 | KN Spittal Millstätter See | Lendorf | 0,74 | 0,0000 | 0,0029 | 0,75 | 0,0000 | 0,0046 | 1,05 | 0,0000 | 0,0067 | 1,05 | 0,0000 | 0,0106 | 1,57 | 0,0000 | 0,0085 | 1,57 | 0,0000 | 0,0134 |
| A10- | Rennweg Katschberg | Gmünd Maltatal | 3,01 | 0,0000 | 0,0119 | 3,02 | 0,0000 | 0,0186 | 4,23 | 0,0000 | 0,0273 | 4,25 | 0,0000 | 0,0428 | 6,34 | 0,0000 | 0,0344 | 6,36 | 0,0000 | 0,0540 |
| A10- | Gmünd Maltatal | KN Spittal Millstätter See | 1,72 | 0,0000 | 0,0067 | 1,72 | 0,0000 | 0,0106 | 2,41 | 0,0000 | 0,0155 | 2,42 | 0,0000 | 0,0244 | 3,61 | 0,0000 | 0,0196 | 3,62 | 0,0000 | 0,0307 |
| A10- | KN Spittal Millstätter See | Spittal Ost | 1,30 | 0,0000 | 0,0051 | 1,30 | 0,0000 | 0,0080 | 1,82 | 0,0000 | 0,0118 | 1,83 | 0,0000 | 0,0185 | 2,73 | 0,0000 | 0,0148 | 2,74 | 0,0000 | 0,0233 |
| A10- | Spittal Ost | Paternion Feistritz | 2,24 | 0,0000 | 0,0088 | 2,25 | 0,0000 | 0,0139 | 3,15 | 0,0000 | 0,0203 | 3,16 | 0,0000 | 0,0319 | 4,72 | 0,0000 | 0,0256 | 4,73 | 0,0000 | 0,0402 |
| A10- | Paternion Feistritz | Villach West | 2,42 | 0,0000 | 0,0095 | 2,42 | 0,0000 | 0,0149 | 3,39 | 0,0000 | 0,0219 | 3,41 | 0,0000 | 0,0344 | 5,09 | 0,0000 | 0,0276 | 5,10 | 0,0000 | 0,0433 |
| A10- | Villach West | Villach Ossiacher See | 1,05 | 0,0000 | 0,0041 | 1,05 | 0,0000 | 0,0065 | 1,47 | 0,0000 | 0,0095 | 1,47 | 0,0000 | 0,0149 | 2,20 | 0,0000 | 0,0119 | 2,21 | 0,0000 | 0,0187 |
| A10- | Villach Ossiacher See | KN Villach | 0,82 | 0,0000 | 0,0032 | 0,82 | 0,0000 | 0,0050 | 1,15 | 0,0000 | 0,0074 | 1,15 | 0,0000 | 0,0116 | 1,72 | 0,0000 | 0,0093 | 1,72 | 0,0000 | 0,0146 |
| A11- | KN Villach | St. Niklas Faakersee | 0,58 | 0,0000 | 0,0023 | 0,59 | 0,0000 | 0,0036 | 0,82 | 0,0000 | 0,0053 | 0,82 | 0,0000 | 0,0083 | 1,23 | 0,0000 | 0,0067 | 1,23 | 0,0000 | 0,0105 |
| A11- | St. Niklas Faakersee | St. Jakob/Rosental | 1,47 | 0,0000 | 0,0058 | 1,47 | 0,0000 | 0,0091 | 2,06 | 0,0000 | 0,0133 | 2,07 | 0,0000 | 0,0209 | 3,09 | 0,0000 | 0,0167 | 3,10 | 0,0000 | 0,0263 |
| A11- | St. Jakob/Rosental | Staatsgrenze Karawankentunnel | 15,29 | 0,0000 | 0,0068 | 15,30 | 0,0000 | 0,0107 | 21,42 | 0,0000 | 0,0156 | 21,42 | 0,0000 | 0,0246 | 32,12 | 0,0000 | 0,0197 | 32,13 | 0,0000 | 0,0310 |
| A12- | Staatsgrenze Kufstein | Kufstein Nord | 0,35 | 0,0000 | 0,0000 | 0,35 | 0,0000 | 0,0000 | 0,50 | 0,0000 | 0,0000 | 0,50 | 0,0000 | 0,0000 | 0,74 | 0,0000 | 0,0000 | 0,74 | 0,0000 | 0,0000 |
| A12- | Kufstein Nord | Kufstein Süd | 0,91 | 0,0000 | 0,0000 | 0,91 | 0,0000 | 0,0000 | 1,27 | 0,0000 | 0,0000 | 1,27 | 0,0000 | 0,0000 | 1,91 | 0,0000 | 0,0000 | 1,91 | 0,0000 | 0,0000 |
| A12- | Kufstein Süd | Kirchbichl Langkampfen | 1,24 | 0,0000 | 0,0000 | 1,24 | 0,0000 | 0,0000 | 1,74 | 0,0000 | 0,0000 | 1,74 | 0,0000 | 0,0000 | 2,60 | 0,0000 | 0,0000 | 2,60 | 0,0000 | 0,0000 |
| A12- | Kirchbichl Langkampfen | Wörgl Ost St.Johann i. T. Brixental | 1,21 | 0,0000 | 0,0000 | 1,21 | 0,0000 | 0,0000 | 1,70 | 0,0000 | 0,0000 | 1,70 | 0,0000 | 0,0000 | 2,55 | 0,0000 | 0,0000 | 2,55 | 0,0000 | 0,0000 |
| A12- | Wörgl Ost St.Johann i. T. Brixental | Wörgl West | 0,64 | 0,0000 | 0,0000 | 0,64 | 0,0000 | 0,0000 | 0,89 | 0,0000 | 0,0000 | 0,89 | 0,0000 | 0,0000 | 1,34 | 0,0000 | 0,0000 | 1,34 | 0,0000 | 0,0000 |
| A12- | Wörgl West | Kramsach Rattenberg Brixlegg | 2,72 | 0,0000 | 0,0000 | 2,72 | 0,0000 | 0,0000 | 3,81 | 0,0000 | 0,0000 | 3,81 | 0,0000 | 0,0000 | 5,72 | 0,0000 | 0,0000 | 5,72 | 0,0000 | 0,0000 |
| A12- | Kramsach Rattenberg Brixlegg | Wiesing Achensee Zillertal | 1,67 | 0,0000 | 0,0000 | 1,67 | 0,0000 | 0,0000 | 2,34 | 0,0000 | 0,0000 | 2,34 | 0,0000 | 0,0000 | 3,51 | 0,0000 | 0,0000 | 3,51 | 0,0000 | 0,0000 |
| A12- | Wiesing Achensee Zillertal | Jenbach | 0,66 | 0,0000 | 0,0000 | 0,66 | 0,0000 | 0,0000 | 0,93 | 0,0000 | 0,0000 | 0,93 | 0,0000 | 0,0000 | 1,39 | 0,0000 | 0,0000 | 1,39 | 0,0000 | 0,0000 |
| A12- | Jenbach | Schwarz | 1,46 | 0,0000 | 0,0000 | 1,46 | 0,0000 | 0,0000 | 2,04 | 0,0000 | 0,0000 | 2,04 | 0,0000 | 0,0000 | 3,06 | 0,0000 | 0,0000 | 3,06 | 0,0000 | 0,0000 |
| A12- | Schwarz | Vomp | 0,83 | 0,0000 | 0,0000 | 0,83 | 0,0000 | 0,0000 | 1,17 | 0,0000 | 0,0000 | 1,17 | 0,0000 | 0,0000 | 1,75 | 0,0000 | 0,0000 | 1,75 | 0,0000 | 0,0000 |
| A12- | Vomp | Wattens | 1,72 | 0,0000 | 0,0000 | 1,72 | 0,0000 | 0,0000 | 2,41 | 0,0000 | 0,0000 | 2,41 | 0,0000 | 0,0000 | 3,61 | 0,0000 | 0,0000 | 3,61 | 0,0000 | 0,0000 |
| A12- | Wattens | Hall/Tirol Mitte | 1,52 | 0,0000 | 0,0000 | 1,52 | 0,0000 | 0,0000 | 2,13 | 0,0000 | 0,0000 | 2,13 | 0,0000 | 0,0000 | 3,20 | 0,0000 | 0,0000 | 3,20 | 0,0000 | 0,0000 |
| A12- | Hall/Tirol Mitte | Hall/Tirol West | 0,61 | 0,0000 | 0,0000 | 0,61 | 0,0000 | 0,0000 | 0,86 | 0,0000 | 0,0000 | 0,86 | 0,0000 | 0,0000 | 1,29 | 0,0000 | 0,0000 | 1,29 | 0,0000 | 0,0000 |
| A12- | Hall/Tirol West | A12 Innsbruck Ost | 0,68 | 0,0000 | 0,0000 | 0,68 | 0,0000 | 0,0000 | 0,95 | 0,0000 | 0,0000 | 0,95 | 0,0000 | 0,0000 | 1,42 | 0,0000 | 0,0000 | 1,42 | 0,0000 | 0,0000 |
| A12- | A12 Innsbruck Ost | Innsbruck Mitte | 0,44 | 0,0000 | 0,0004 | 0,44 | 0,0000 | 0,0006 | 0,62 | 0,0000 | 0,0009 | 0,62 | 0,0000 | 0,0014 | 0,93 | 0,0000 | 0,0011 | 0,93 | 0,0000 | 0,0018 |
| A12- | Innsbruck Mitte | A12 Innsbruck West | 0,57 | 0,0000 | 0,0022 | 0,57 | 0,0000 | 0,0035 | 0,80 | 0,0000 | 0,0052 | 0,80 | 0,0000 | 0,0081 | 1,20 | 0,0000 | 0,0065 | 1,20 | 0,0000 | 0,0102 |
| A12- | A12 Innsbruck West | Innsbruck Kranebitten | 0,75 | 0,0000 | 0,0029 | 0,75 | 0,0000 | 0,0046 | 1,05 | 0,0000 | 0,0068 | 1,05 | 0,0000 | 0,0106 | 1,57 | 0,0000 | 0,0085 | 1,58 | 0,0000 | 0,0134 |
| A12- | Innsbruck Kranebitten | Zirl Ost Garmisch Seefeld | 0,87 | 0,0000 | 0,0034 | 0,87 | 0,0000 | 0,0054 | 1,22 | 0,0000 | 0,0078 | 1,22 | 0,0000 | 0,0123 | 1,82 | 0,0000 | 0,0099 | 1,83 | 0,0000 | 0,0155 |
| A12- | Zirl Ost Garmisch Seefeld | Zirl West | 0,54 | 0,0000 | 0,0021 | 0,54 | 0,0000 | 0,0033 | 0,76 | 0,0000 | 0,0049 | 0,76 | 0,0000 | 0,0077 | 1,14 | 0,0000 | 0,0062 | 1,14 | 0,0000 | 0,0097 |
| A12- | Zirl West | Petttau | 0,97 | 0,0000 | 0,0038 | 0,97 | 0,0000 | 0,0060 | 1,36 | 0,0000 | 0,0088 | 1,37 | 0,0000 | 0,0138 | 2,04 | 0,0000 | 0,0111 | 2,05 | 0,0000 | 0,0174 |
| A12- | Petttau | Telfs Ost | 0,98 | 0,0000 | 0,0039 | 0,98 | 0,0000 | 0,0061 | 1,38 | 0,0000 | 0,0089 | 1,38 | 0,0000 | 0,0139 | 2,06 | 0,0000 | 0,0112 | 2,07 | 0,0000 | 0,0176 |
| A12- | Telfs Ost | Telfs West | 0,48 | 0,0000 | 0,0019 | 0,48 | 0,0000 | 0,0030 | 0,67 | 0,0000 | 0,0043 | 0,68 | 0,0000 | 0,0068 | 1,01 | 0,0000 | 0,0055 | 1,01 | 0,0000 | 0,0086 |
| A12- | Telfs West | Mötz Reutte | 1,55 | 0,0000 | 0,0061 | 1,55 | 0,0000 | 0,0096 | 2,17 | 0,0000 | | | | | | | | | | |

| | | | | | | | | | | | | | | | | | | | | |
|------|------------------------------------|------------------------------------|------|--------|--------|------|--------|--------|------|--------|--------|------|--------|--------|------|--------|--------|------|--------|--------|
| A14- | Staatsgrenze Hörbranz | Hörbranz Lochau | 0,22 | 0,0000 | 0,0009 | 0,23 | 0,0000 | 0,0014 | 0,32 | 0,0000 | 0,0020 | 0,32 | 0,0000 | 0,0032 | 0,47 | 0,0000 | 0,0026 | 0,47 | 0,0000 | 0,0040 |
| A14- | Hörbranz Lochau | KN Bregenz | 1,38 | 0,0000 | 0,0054 | 1,38 | 0,0000 | 0,0085 | 1,94 | 0,0000 | 0,0125 | 1,94 | 0,0000 | 0,0196 | 2,90 | 0,0000 | 0,0157 | 2,91 | 0,0000 | 0,0247 |
| A14- | KN Bregenz | Lauterach Wolfurt | 0,07 | 0,0000 | 0,0003 | 0,07 | 0,0000 | 0,0004 | 0,10 | 0,0000 | 0,0006 | 0,10 | 0,0000 | 0,0010 | 0,15 | 0,0000 | 0,0008 | 0,15 | 0,0000 | 0,0012 |
| A14- | Lauterach Wolfurt | Wolfurt Lauterach | 0,61 | 0,0000 | 0,0024 | 0,62 | 0,0000 | 0,0038 | 0,86 | 0,0000 | 0,0056 | 0,86 | 0,0000 | 0,0087 | 1,29 | 0,0000 | 0,0070 | 1,29 | 0,0000 | 0,0110 |
| A14- | Wolfurt Lauterach | Dornbirn Nord Bregenzerwald | 0,24 | 0,0000 | 0,0009 | 0,24 | 0,0000 | 0,0015 | 0,33 | 0,0000 | 0,0021 | 0,33 | 0,0000 | 0,0034 | 0,50 | 0,0000 | 0,0027 | 0,50 | 0,0000 | 0,0043 |
| A14- | Dornbirn Nord Bregenzerwald | Dornbirn Süd Lustenau | 0,66 | 0,0000 | 0,0026 | 0,66 | 0,0000 | 0,0041 | 0,93 | 0,0000 | 0,0060 | 0,93 | 0,0000 | 0,0094 | 1,40 | 0,0000 | 0,0076 | 1,40 | 0,0000 | 0,0119 |
| A14- | Dornbirn Süd Lustenau | Hohenems | 0,93 | 0,0000 | 0,0037 | 0,94 | 0,0000 | 0,0058 | 1,31 | 0,0000 | 0,0084 | 1,32 | 0,0000 | 0,0133 | 1,96 | 0,0000 | 0,0106 | 1,97 | 0,0000 | 0,0167 |
| A14- | Hohenems | Altach Götzis | 0,61 | 0,0000 | 0,0024 | 0,61 | 0,0000 | 0,0038 | 0,85 | 0,0000 | 0,0055 | 0,86 | 0,0000 | 0,0087 | 1,28 | 0,0000 | 0,0069 | 1,28 | 0,0000 | 0,0109 |
| A14- | Altach Götzis | Götzis | 0,46 | 0,0000 | 0,0018 | 0,47 | 0,0000 | 0,0029 | 0,65 | 0,0000 | 0,0042 | 0,65 | 0,0000 | 0,0066 | 0,98 | 0,0000 | 0,0053 | 0,98 | 0,0000 | 0,0083 |
| A14- | Götzis | Klaus Koblach | 0,40 | 0,0000 | 0,0016 | 0,40 | 0,0000 | 0,0025 | 0,57 | 0,0000 | 0,0036 | 0,57 | 0,0000 | 0,0057 | 0,85 | 0,0000 | 0,0046 | 0,85 | 0,0000 | 0,0072 |
| A14- | Klaus Koblach | Rankweil | 0,71 | 0,0000 | 0,0028 | 0,71 | 0,0000 | 0,0044 | 0,99 | 0,0000 | 0,0064 | 1,00 | 0,0000 | 0,0101 | 1,49 | 0,0000 | 0,0081 | 1,49 | 0,0000 | 0,0127 |
| A14- | Rankweil | Feldkirch Frastanz | 1,01 | 0,0000 | 0,0040 | 1,01 | 0,0000 | 0,0062 | 1,42 | 0,0000 | 0,0091 | 1,42 | 0,0000 | 0,0143 | 2,12 | 0,0000 | 0,0115 | 2,13 | 0,0000 | 0,0181 |
| A14- | Feldkirch Frastanz | Nenzing Bludesch | 1,60 | 0,0000 | 0,0063 | 1,60 | 0,0000 | 0,0099 | 2,24 | 0,0000 | 0,0144 | 2,25 | 0,0000 | 0,0227 | 3,36 | 0,0000 | 0,0182 | 3,37 | 0,0000 | 0,0286 |
| A14- | Nenzing Bludesch | Bludenz Nüziders | 1,18 | 0,0000 | 0,0047 | 1,19 | 0,0000 | 0,0073 | 1,66 | 0,0000 | 0,0107 | 1,67 | 0,0000 | 0,0168 | 2,49 | 0,0000 | 0,0135 | 2,50 | 0,0000 | 0,0212 |
| A14- | Bludenz Nüziders | Brandnertal | 0,16 | 0,0000 | 0,0006 | 0,17 | 0,0000 | 0,0010 | 0,23 | 0,0000 | 0,0015 | 0,23 | 0,0000 | 0,0023 | 0,35 | 0,0000 | 0,0019 | 0,35 | 0,0000 | 0,0030 |
| A14- | Brandnertal | Bludenz Bürs | 0,28 | 0,0000 | 0,0011 | 0,28 | 0,0000 | 0,0017 | 0,39 | 0,0000 | 0,0025 | 0,39 | 0,0000 | 0,0039 | 0,58 | 0,0000 | 0,0031 | 0,58 | 0,0000 | 0,0049 |
| A14- | Bludenz Bürs | Bludenz Montafon | 0,39 | 0,0000 | 0,0015 | 0,39 | 0,0000 | 0,0024 | 0,55 | 0,0000 | 0,0035 | 0,55 | 0,0000 | 0,0055 | 0,82 | 0,0000 | 0,0044 | 0,82 | 0,0000 | 0,0070 |
| A141 | KN Bregenz | Bregenz Citytunnel | 0,36 | 0,0000 | 0,0014 | 0,36 | 0,0000 | 0,0022 | 0,50 | 0,0000 | 0,0032 | 0,50 | 0,0000 | 0,0051 | 0,75 | 0,0000 | 0,0041 | 0,75 | 0,0000 | 0,0064 |
| A21- | KN Steinhäusl | Hochstraß | 0,59 | 0,0000 | 0,0023 | 0,59 | 0,0000 | 0,0036 | 0,83 | 0,0000 | 0,0053 | 0,83 | 0,0000 | 0,0084 | 1,24 | 0,0000 | 0,0067 | 1,24 | 0,0000 | 0,0106 |
| A21- | Hochstraß | Alland | 2,06 | 0,0000 | 0,0081 | 2,06 | 0,0000 | 0,0127 | 2,89 | 0,0000 | 0,0186 | 2,90 | 0,0000 | 0,0292 | 4,33 | 0,0000 | 0,0235 | 4,34 | 0,0000 | 0,0369 |
| A21- | Alland | Mayerling | 0,42 | 0,0000 | 0,0016 | 0,42 | 0,0000 | 0,0026 | 0,59 | 0,0000 | 0,0038 | 0,59 | 0,0000 | 0,0059 | 0,88 | 0,0000 | 0,0048 | 0,88 | 0,0000 | 0,0075 |
| A21- | Mayerling | Heiligenkreuz | 0,97 | 0,0000 | 0,0038 | 0,97 | 0,0000 | 0,0060 | 1,36 | 0,0000 | 0,0088 | 1,36 | 0,0000 | 0,0138 | 2,04 | 0,0000 | 0,0110 | 2,04 | 0,0000 | 0,0173 |
| A21- | Heiligenkreuz | Heiligenbrühl | 0,54 | 0,0000 | 0,0021 | 0,54 | 0,0000 | 0,0033 | 0,76 | 0,0000 | 0,0049 | 0,76 | 0,0000 | 0,0077 | 1,13 | 0,0000 | 0,0062 | 1,14 | 0,0000 | 0,0097 |
| A21- | Hinterbrühl | Gießhübl | 1,01 | 0,0000 | 0,0040 | 1,01 | 0,0000 | 0,0063 | 1,42 | 0,0000 | 0,0092 | 1,43 | 0,0000 | 0,0144 | 2,13 | 0,0000 | 0,0115 | 2,13 | 0,0000 | 0,0181 |
| A21- | Gießhübl | Brunn/Gebirge | 0,85 | 0,0000 | 0,0033 | 0,85 | 0,0000 | 0,0052 | 1,19 | 0,0000 | 0,0077 | 1,19 | 0,0000 | 0,0120 | 1,78 | 0,0000 | 0,0097 | 1,79 | 0,0000 | 0,0152 |
| A21- | Brunn/Gebirge | KN Vösendorf | 0,38 | 0,0000 | 0,0015 | 0,38 | 0,0000 | 0,0023 | 0,53 | 0,0000 | 0,0034 | 0,53 | 0,0000 | 0,0054 | 0,79 | 0,0000 | 0,0043 | 0,79 | 0,0000 | 0,0068 |
| A22- | KN Wien Kaisermühlen | Kaisermühlen | 0,30 | 0,0000 | 0,0012 | 0,30 | 0,0000 | 0,0018 | 0,42 | 0,0000 | 0,0027 | 0,42 | 0,0000 | 0,0042 | 0,63 | 0,0000 | 0,0034 | 0,63 | 0,0000 | 0,0053 |
| A22- | Kaisermühlen | Reichsbrücke | 0,25 | 0,0000 | 0,0010 | 0,25 | 0,0000 | 0,0015 | 0,35 | 0,0000 | 0,0022 | 0,35 | 0,0000 | 0,0035 | 0,52 | 0,0000 | 0,0028 | 0,52 | 0,0000 | 0,0044 |
| A22- | Reichsbrücke | Kagran Vienna International Center | 0,10 | 0,0000 | 0,0004 | 0,10 | 0,0000 | 0,0006 | 0,13 | 0,0000 | 0,0009 | 0,13 | 0,0000 | 0,0014 | 0,20 | 0,0000 | 0,0011 | 0,20 | 0,0000 | 0,0017 |
| A22- | Kagran Vienna International Center | Brigittenerbrücke | 0,15 | 0,0000 | 0,0006 | 0,15 | 0,0000 | 0,0009 | 0,21 | 0,0000 | 0,0014 | 0,21 | 0,0000 | 0,0022 | 0,32 | 0,0000 | 0,0017 | 0,32 | 0,0000 | 0,0027 |
| A22- | Brigittenerbrücke | Floridsdorferbrücke | 0,25 | 0,0000 | 0,0010 | 0,25 | 0,0000 | 0,0015 | 0,34 | 0,0000 | 0,0022 | 0,35 | 0,0000 | 0,0035 | 0,52 | 0,0000 | 0,0028 | 0,52 | 0,0000 | 0,0044 |
| A22- | Floridsdorferbrücke | KN Gürtel Nordbrücke | 0,16 | 0,0000 | 0,0006 | 0,16 | 0,0000 | 0,0010 | 0,22 | 0,0000 | 0,0014 | 0,22 | 0,0000 | 0,0022 | 0,33 | 0,0000 | 0,0018 | 0,33 | 0,0000 | 0,0028 |
| A22- | KN Gürtel Nordbrücke | Strebersdorf | 0,54 | 0,0000 | 0,0021 | 0,54 | 0,0000 | 0,0033 | 0,75 | 0,0000 | 0,0048 | 0,75 | 0,0000 | 0,0076 | 1,13 | 0,0000 | 0,0061 | 1,13 | 0,0000 | 0,0096 |
| A221 | Wien Nordbrücke | KN Gürtel Nordbrücke | 0,16 | 0,0000 | 0,0006 | 0,16 | 0,0000 | 0,0010 | 0,22 | 0,0000 | 0,0014 | 0,22 | 0,0000 | 0,0022 | 0,33 | 0,0000 | 0,0018 | 0,33 | 0,0000 | 0,0028 |
| A221 | KN Gürtel Nordbrücke | Wien Pragerstraße | 0,17 | 0,0000 | 0,0007 | 0,17 | 0,0000 | 0,0011 | 0,24 | 0,0000 | 0,0015 | 0,24 | 0,0000 | 0,0024 | 0,36 | 0,0000 | 0,0019 | 0,36 | 0,0000 | 0,0030 |
| A221 | Wien Pragerstraße | Wien Neujedlersdorf | 0,07 | 0,0000 | 0,0003 | 0,07 | 0,0000 | 0,0005 | 0,10 | 0,0000 | 0,0007 | 0,10 | 0,0000 | 0,0011 | 0,16 | 0,0000 | 0,0008 | 0,16 | 0,0000 | 0,0013 |
| A221 | Wien Neujedlersdorf | Brünnerstr/Shuttlewortstraße | 0,19 | 0,0000 | 0,0007 | 0,19 | 0,0000 | 0,0012 | 0,26 | 0,0000 | 0,0017 | 0,27 | 0,0000 | 0,0027 | 0,40 | 0,0000 | 0,0022 | 0,40 | 0,0000 | 0,0034 |
| A22- | Strebersdorf | Korneuburg Ost | 1,08 | 0,0000 | 0,0042 | 1,08 | 0,0000 | 0,0067 | 1,51 | 0,0000 | 0,0098 | 1,52 | 0,0000 | 0,0153 | 2,27 | 0,0000 | 0,0123 | 2,28 | 0,0000 | 0,0193 |
| A222 | Strebersdorf | Wien Vohburggasse | 0,13 | 0,0000 | 0,0005 | 0,13 | 0,0000 | 0,0008 | 0,19 | 0,0000 | 0,0012 | 0,19 | 0,0000 | 0,0019 | 0,28 | 0,0000 | 0,0015 | 0,28 | 0,0000 | 0,0024 |
| A22- | Korneuburg Ost | KN Korneuburg | 0,70 | 0,0000 | 0,0027 | 0,70 | 0,0000 | 0,0043 | 0,98 | 0,0000 | 0,0063 | 0,98 | 0,0000 | 0,0099 | 1,46 | 0,0000 | 0,0079 | 1,47 | 0,0000 | 0,0125 |
| A22- | KN Korneuburg | Stockerau Ost | 1,01 | 0,0000 | 0,0040 | 1,02 | 0,0000 | 0,0063 | 1,42 | 0,0000 | 0,0092 | 1,43 | 0,0000 | 0,0144 | 2,13 | 0,0000 | 0,0116 | 2,14 | 0,0000 | 0,0182 |
| A22- | Stockerau Ost | Stockerau Mitte | 0,40 | 0,0000 | 0,0016 | 0,40 | 0,0000 | 0,0025 | 0,57 | 0,0000 | 0,0037 | 0,57 | 0,0000 | 0,0057 | 0,85 | 0,0000 | 0,0046 | 0,85 | 0,0000 | 0,0072 |
| A22- | Stockerau Mitte | KN Stockerau/West | 0,34 | 0,0000 | 0,0013 | 0,34 | 0,0000 | 0,0021 | 0,48 | 0,0000 | 0,0031 | 0,48 | 0,0000 | 0,0049 | 0,72 | 0,0000 | 0,0039 | 0,72 | 0,0000 | 0,0061 |
| A23- | Altmannsdorferstraße | KN Wien Inzersdorf | 0,30 | 0,0000 | 0,0012 | 0,30 | 0,0000 | 0,0019 | 0,42 | 0,0000 | 0,0027 | 0,42 | 0,0000 | 0,0043 | 0,63 | 0,0000 | 0,0034 | 0,63 | 0,0000 | 0,0054 |
| A23- | KN Wien Inzersdorf | Favoriten | 0,76 | 0,0000 | 0,0030 | 0,76 | 0,0000 | 0,0047 | 1,06 | 0,0000 | 0,0068 | 1,07 | 0,0000 | 0,0108 | 1,59 | 0,0000 | 0,0086 | 1,60 | 0,0000 | 0,0136 |
| A23- | Favoriten | KN Gürtel Landstraßer Hauptstraße | 0,47 | 0,0000 | 0,0019 | 0,48 | 0,0000 | 0,0029 | 0,67 | 0,0000 | 0,0043 | 0,67 | 0,0000 | 0,0067 | 1,00 | 0,0000 | 0,0054 | 1,00 | 0,0000 | 0,0085 |
| A23- | KN Gürtel Landstraßer Hauptstraße | St. Marx | 0,18 | 0,0000 | 0,0007 | 0,18 | 0,0000 | 0,0011 | 0,25 | 0,0000 | 0,0016 | 0,25 | 0,0000 | 0,0026 | 0,38 | 0,0000 | 0,0021 | 0,38 | 0,0000 | 0,0032 |
| A23- | St. Marx | KN Wien Prater | 0,15 | 0,0000 | 0,0006 | 0,15 | 0,0000 | 0,0009 | 0,21 | 0,0000 | 0,0014 | 0,22 | 0,0000 | 0,0022 | 0,32 | 0,0000 | 0,0017 | 0,32 | 0,0000 | 0,0027 |
| A23- | KN Wien Prater | Handelskai | 0,34 | 0,0000 | 0,0013 | 0,34 | 0,0000 | 0,0021 | 0,48 | 0,0000 | 0,0031 | 0,48 | 0,0000 | 0,0048 | 0,71 | 0,0000 | 0,0039 | 0,72 | 0,0000 | 0,0061 |
| A23- | Handelskai | KN Wien Kaisermühlen | 0,16 | 0,0000 | 0,0006 | 0,16 | 0,0000 | 0,0010 | 0,22 | 0,0000 | 0,0014 | 0,22 | 0,0000 | 0,0022 | 0,33 | 0,0000 | 0,0018 | 0,33 | 0,0000 | 0,0028 |
| A23- | KN Wien Kaisermühlen | Groß Enzersdorf Stadlau | 0,43 | 0,0000 | 0,0017 | 0,43 | 0,0000 | 0,0026 | 0,60 | 0,0000 | 0,0038 | 0,60 | 0,0000 | 0,0060 | 0,89 | 0,0000 | 0,0049 | 0,90 | 0,0000 | 0,0076 |
| A23- | Groß Enzersdorf Stadlau | Hirschstetten | 0,24 | 0,0000 | 0,0009 | 0,24 | 0,0000 | 0,0015 | 0,33 | 0,0000 | 0,0022 | 0,34 | 0,0000 | 0,0034 | 0,50 | 0,0000 | 0,0027 | 0,50 | 0,0000 | 0,0043 |
| A233 | KN Gürtel Landstraßer Hauptstraße | Wien Gürtel | 0,14 | 0,0000 | 0,0005 | 0,14 | 0,0000 | 0,0009 | 0,20 | 0,0000 | 0,0013 | 0,20 | 0,0000 | 0,0020 | 0,29 | 0,0000 | 0,0016 | 0,29 | 0,0000 | 0,0025 |
| A25- | KN A1/A25 Passau Wels | Weißkirchen | 1,57 | 0,0000 | 0,0062 | 1,57 | 0,0000 | 0,0097 | 2,20 | 0,0000 | 0,0142 | 2,21 | 0,0000 | 0,0223 | 3,30 | 0,0000 | 0,0179 | 3,31 | 0,0000 | 0,0281 |
| A25- | Weißkirchen | Marchtrenk Wels Ost | 0,56 | 0,0000 | 0,0022 | 0,56 | 0,0000 | 0,0035 | 0,78 | 0,0000 | 0,0051 | 0,79 | 0,0000 | 0,0079 | 1,18 | 0,0000 | 0,0064 | 1,18 | 0,0000 | 0,0100 |
| A25- | Marchtrenk Wels Ost | ÖBB Terminal Wels | 0,15 | 0,0000 | 0,0006 | 0,15 | 0,0000 | 0,0009 | 0,21 | 0,0000 | 0,0014 | 0,21 | 0,0000 | 0,0021 | 0,32 | 0,0000 | 0,0017 | 0,32 | 0,0000 | 0,0027 |
| A | | | | | | | | | | | | | | | | | | | | |

| | | | | | | | | | | | | | | | | | | | | |
|------|-----------------------------------|-----------------------------------|------|--------|--------|------|--------|--------|------|--------|--------|------|--------|--------|------|--------|--------|------|--------|--------|
| S01- | Seyring | KN Eibesbrunn | 0,73 | 0,0000 | 0,0029 | 0,74 | 0,0000 | 0,0045 | 1,03 | 0,0000 | 0,0066 | 1,03 | 0,0000 | 0,0104 | 1,54 | 0,0000 | 0,0084 | 1,55 | 0,0000 | 0,0131 |
| S01- | KN Eibesbrunn | Hagenbrunn | 0,58 | 0,0000 | 0,0023 | 0,58 | 0,0000 | 0,0036 | 0,81 | 0,0000 | 0,0052 | 0,81 | 0,0000 | 0,0082 | 1,21 | 0,0000 | 0,0066 | 1,22 | 0,0000 | 0,0104 |
| S01- | Hagenbrunn | Korneuburg Nord | 1,24 | 0,0000 | 0,0049 | 1,24 | 0,0000 | 0,0076 | 1,73 | 0,0000 | 0,0112 | 1,74 | 0,0000 | 0,0176 | 2,60 | 0,0000 | 0,0141 | 2,61 | 0,0000 | 0,0221 |
| S01- | Korneuburg Nord | Korneuburg West | 0,50 | 0,0000 | 0,0020 | 0,50 | 0,0000 | 0,0031 | 0,70 | 0,0000 | 0,0045 | 0,71 | 0,0000 | 0,0071 | 1,05 | 0,0000 | 0,0057 | 1,06 | 0,0000 | 0,0090 |
| S01- | Korneuburg West | KN Korneuburg | 0,16 | 0,0000 | 0,0006 | 0,16 | 0,0000 | 0,0010 | 0,22 | 0,0000 | 0,0014 | 0,23 | 0,0000 | 0,0023 | 0,34 | 0,0000 | 0,0018 | 0,34 | 0,0000 | 0,0029 |
| S02- | Hirschstetten | Gewerbepark Stadlau | 0,17 | 0,0000 | 0,0007 | 0,17 | 0,0000 | 0,0011 | 0,24 | 0,0000 | 0,0016 | 0,24 | 0,0000 | 0,0024 | 0,36 | 0,0000 | 0,0020 | 0,36 | 0,0000 | 0,0031 |
| S02- | Gewerbepark Stadlau | Breitenleer Straße | 0,10 | 0,0000 | 0,0004 | 0,10 | 0,0000 | 0,0006 | 0,13 | 0,0000 | 0,0009 | 0,13 | 0,0000 | 0,0014 | 0,20 | 0,0000 | 0,0011 | 0,20 | 0,0000 | 0,0017 |
| S02- | Breitenleer Straße | Rautenweg | 0,16 | 0,0000 | 0,0006 | 0,16 | 0,0000 | 0,0010 | 0,22 | 0,0000 | 0,0014 | 0,22 | 0,0000 | 0,0022 | 0,33 | 0,0000 | 0,0018 | 0,33 | 0,0000 | 0,0028 |
| S02- | Rautenweg | Hermann Gebauer Straße | 0,17 | 0,0000 | 0,0007 | 0,17 | 0,0000 | 0,0011 | 0,24 | 0,0000 | 0,0016 | 0,24 | 0,0000 | 0,0025 | 0,37 | 0,0000 | 0,0020 | 0,37 | 0,0000 | 0,0031 |
| S02- | Hermann Gebauer Straße | Angerner Straße | 0,63 | 0,0000 | 0,0025 | 0,63 | 0,0000 | 0,0039 | 0,88 | 0,0000 | 0,0057 | 0,89 | 0,0000 | 0,0089 | 1,32 | 0,0000 | 0,0072 | 1,33 | 0,0000 | 0,0113 |
| S03- | KN Stockerau/West | Stockerau Nord | 0,18 | 0,0000 | 0,0007 | 0,18 | 0,0000 | 0,0011 | 0,25 | 0,0000 | 0,0016 | 0,25 | 0,0000 | 0,0025 | 0,37 | 0,0000 | 0,0020 | 0,37 | 0,0000 | 0,0032 |
| S03- | Stockerau Nord | Sierndorf | 0,95 | 0,0000 | 0,0038 | 0,96 | 0,0000 | 0,0059 | 1,34 | 0,0000 | 0,0086 | 1,35 | 0,0000 | 0,0136 | 2,01 | 0,0000 | 0,0109 | 2,01 | 0,0000 | 0,0171 |
| S03- | Sierndorf | Obermallebarn | 0,64 | 0,0000 | 0,0025 | 0,64 | 0,0000 | 0,0040 | 0,90 | 0,0000 | 0,0058 | 0,90 | 0,0000 | 0,0091 | 1,35 | 0,0000 | 0,0073 | 1,35 | 0,0000 | 0,0115 |
| S03- | Obermallebarn | Göllersdorf | 0,85 | 0,0000 | 0,0033 | 0,85 | 0,0000 | 0,0052 | 1,19 | 0,0000 | 0,0077 | 1,19 | 0,0000 | 0,0120 | 1,78 | 0,0000 | 0,0097 | 1,79 | 0,0000 | 0,0152 |
| S03- | Göllersdorf | Großstelzendorf | 0,34 | 0,0000 | 0,0013 | 0,34 | 0,0000 | 0,0021 | 0,48 | 0,0000 | 0,0031 | 0,48 | 0,0000 | 0,0048 | 0,71 | 0,0000 | 0,0039 | 0,72 | 0,0000 | 0,0061 |
| S03- | Großstelzendorf | Hollabrunn Süd | 0,82 | 0,0000 | 0,0032 | 0,82 | 0,0000 | 0,0050 | 1,14 | 0,0000 | 0,0074 | 1,15 | 0,0000 | 0,0116 | 1,71 | 0,0000 | 0,0093 | 1,72 | 0,0000 | 0,0146 |
| S04- | KN Mattersburg | Sigleß | 0,42 | 0,0000 | 0,0017 | 0,42 | 0,0000 | 0,0026 | 0,59 | 0,0000 | 0,0038 | 0,59 | 0,0000 | 0,0060 | 0,89 | 0,0000 | 0,0048 | 0,89 | 0,0000 | 0,0076 |
| S04- | Sigleß | Bad Sauerbrunn | 0,98 | 0,0000 | 0,0039 | 0,99 | 0,0000 | 0,0061 | 1,38 | 0,0000 | 0,0089 | 1,39 | 0,0000 | 0,0140 | 2,07 | 0,0000 | 0,0112 | 2,08 | 0,0000 | 0,0177 |
| S04- | Bad Sauerbrunn | Neudörfel | 0,41 | 0,0000 | 0,0016 | 0,41 | 0,0000 | 0,0026 | 0,58 | 0,0000 | 0,0037 | 0,58 | 0,0000 | 0,0059 | 0,87 | 0,0000 | 0,0047 | 0,87 | 0,0000 | 0,0074 |
| S04- | Neudörfel | Wr.Neustadt Ost | 0,43 | 0,0000 | 0,0017 | 0,43 | 0,0000 | 0,0027 | 0,61 | 0,0000 | 0,0039 | 0,61 | 0,0000 | 0,0062 | 0,91 | 0,0000 | 0,0049 | 0,91 | 0,0000 | 0,0078 |
| S04- | Wr.Neustadt Ost | Katzelsdorf | 0,20 | 0,0000 | 0,0008 | 0,20 | 0,0000 | 0,0013 | 0,28 | 0,0000 | 0,0018 | 0,29 | 0,0000 | 0,0029 | 0,43 | 0,0000 | 0,0023 | 0,43 | 0,0000 | 0,0036 |
| S04- | Katzelsdorf | Lanzenkirchen | 0,17 | 0,0000 | 0,0007 | 0,17 | 0,0000 | 0,0010 | 0,24 | 0,0000 | 0,0015 | 0,24 | 0,0000 | 0,0024 | 0,36 | 0,0000 | 0,0019 | 0,36 | 0,0000 | 0,0030 |
| S04- | Lanzenkirchen | Wr.Neustadt Süd | 0,15 | 0,0000 | 0,0006 | 0,15 | 0,0000 | 0,0009 | 0,21 | 0,0000 | 0,0014 | 0,21 | 0,0000 | 0,0021 | 0,32 | 0,0000 | 0,0017 | 0,32 | 0,0000 | 0,0027 |
| S04- | Wr.Neustadt Süd | KN Wr. Neustadt | 0,25 | 0,0000 | 0,0010 | 0,25 | 0,0000 | 0,0015 | 0,35 | 0,0000 | 0,0023 | 0,35 | 0,0000 | 0,0035 | 0,52 | 0,0000 | 0,0028 | 0,53 | 0,0000 | 0,0045 |
| S05- | KN Stockerau/West | Tulln | 1,72 | 0,0000 | 0,0068 | 1,72 | 0,0000 | 0,0106 | 2,41 | 0,0000 | 0,0156 | 2,42 | 0,0000 | 0,0244 | 3,62 | 0,0000 | 0,0196 | 3,63 | 0,0000 | 0,0308 |
| S05- | Tulln | Königsbrunn / Wagram | 2,15 | 0,0000 | 0,0085 | 2,16 | 0,0000 | 0,0133 | 3,02 | 0,0000 | 0,0195 | 3,03 | 0,0000 | 0,0306 | 4,53 | 0,0000 | 0,0246 | 4,54 | 0,0000 | 0,0386 |
| S05- | Königsbrunn / Wagram | Kirchberg/Wagram | 0,57 | 0,0000 | 0,0023 | 0,58 | 0,0000 | 0,0035 | 0,81 | 0,0000 | 0,0052 | 0,81 | 0,0000 | 0,0082 | 1,21 | 0,0000 | 0,0065 | 1,21 | 0,0000 | 0,0103 |
| S05- | Kirchberg/Wagram | Fels / Wagram | 0,43 | 0,0000 | 0,0017 | 0,43 | 0,0000 | 0,0027 | 0,60 | 0,0000 | 0,0039 | 0,61 | 0,0000 | 0,0061 | 0,90 | 0,0000 | 0,0049 | 0,91 | 0,0000 | 0,0077 |
| S05- | Fels / Wagram | Grafenwörth | 0,99 | 0,0000 | 0,0039 | 0,99 | 0,0000 | 0,0061 | 1,39 | 0,0000 | 0,0090 | 1,39 | 0,0000 | 0,0141 | 2,08 | 0,0000 | 0,0113 | 2,09 | 0,0000 | 0,0177 |
| S05- | Grafenwörth | Jettsdorf | 0,44 | 0,0000 | 0,0017 | 0,44 | 0,0000 | 0,0027 | 0,62 | 0,0000 | 0,0040 | 0,62 | 0,0000 | 0,0063 | 0,93 | 0,0000 | 0,0050 | 0,93 | 0,0000 | 0,0079 |
| S06- | KN Seebein | Neunkirchen | 0,68 | 0,0000 | 0,0027 | 0,68 | 0,0000 | 0,0042 | 0,95 | 0,0000 | 0,0061 | 0,95 | 0,0000 | 0,0096 | 1,42 | 0,0000 | 0,0077 | 1,43 | 0,0000 | 0,0121 |
| S06- | Neunkirchen | Gloggnitz | 2,17 | 0,0000 | 0,0085 | 2,17 | 0,0000 | 0,0134 | 3,04 | 0,0000 | 0,0196 | 3,05 | 0,0000 | 0,0308 | 4,56 | 0,0000 | 0,0247 | 4,57 | 0,0000 | 0,0388 |
| S06- | Gloggnitz | Maria Schutz | 1,38 | 0,0000 | 0,0054 | 1,38 | 0,0000 | 0,0085 | 1,94 | 0,0000 | 0,0125 | 1,95 | 0,0000 | 0,0196 | 2,90 | 0,0000 | 0,0157 | 2,91 | 0,0000 | 0,0247 |
| S06- | Maria Schutz | Spital / Semmering | 1,17 | 0,0000 | 0,0046 | 1,17 | 0,0000 | 0,0072 | 1,64 | 0,0000 | 0,0106 | 1,65 | 0,0000 | 0,0167 | 2,46 | 0,0000 | 0,0134 | 2,47 | 0,0000 | 0,0210 |
| S06- | Spital / Semmering | Mürzzuschlag Ost | 0,98 | 0,0000 | 0,0039 | 0,98 | 0,0000 | 0,0061 | 1,37 | 0,0000 | 0,0089 | 1,38 | 0,0000 | 0,0139 | 2,06 | 0,0000 | 0,0112 | 2,07 | 0,0000 | 0,0175 |
| S06- | Mürzzuschlag Ost | Mariazell, Mürzsteg, Mürzzuschlag | 0,87 | 0,0000 | 0,0034 | 0,87 | 0,0000 | 0,0054 | 1,22 | 0,0000 | 0,0079 | 1,22 | 0,0000 | 0,0123 | 1,83 | 0,0000 | 0,0099 | 1,83 | 0,0000 | 0,0156 |
| S06- | Mariazell, Mürzsteg, Mürzzuschlag | Hönigsberg | 0,62 | 0,0000 | 0,0024 | 0,62 | 0,0000 | 0,0038 | 0,87 | 0,0000 | 0,0056 | 0,87 | 0,0000 | 0,0088 | 1,30 | 0,0000 | 0,0071 | 1,31 | 0,0000 | 0,0111 |
| S06- | Hönigsberg | Langenwang | 0,34 | 0,0000 | 0,0013 | 0,34 | 0,0000 | 0,0021 | 0,48 | 0,0000 | 0,0031 | 0,48 | 0,0000 | 0,0049 | 0,72 | 0,0000 | 0,0039 | 0,72 | 0,0000 | 0,0061 |
| S06- | Langenwang | Krieglach | 0,41 | 0,0000 | 0,0016 | 0,41 | 0,0000 | 0,0025 | 0,57 | 0,0000 | 0,0037 | 0,57 | 0,0000 | 0,0058 | 0,86 | 0,0000 | 0,0046 | 0,86 | 0,0000 | 0,0073 |
| S06- | Krieglach | Mitterdorf | 1,03 | 0,0000 | 0,0040 | 1,03 | 0,0000 | 0,0064 | 1,44 | 0,0000 | 0,0093 | 1,45 | 0,0000 | 0,0146 | 2,16 | 0,0000 | 0,0117 | 2,17 | 0,0000 | 0,0184 |
| S06- | Mitterdorf | Kindberg Ost | 1,04 | 0,0000 | 0,0041 | 1,05 | 0,0000 | 0,0065 | 1,47 | 0,0000 | 0,0095 | 1,47 | 0,0000 | 0,0149 | 2,20 | 0,0000 | 0,0119 | 2,20 | 0,0000 | 0,0187 |
| S06- | Kindberg Ost | Kindberg West | 0,22 | 0,0000 | 0,0009 | 0,22 | 0,0000 | 0,0014 | 0,31 | 0,0000 | 0,0020 | 0,32 | 0,0000 | 0,0032 | 0,47 | 0,0000 | 0,0026 | 0,47 | 0,0000 | 0,0040 |
| S06- | Kindberg West | Kindberg Dörfel | 0,22 | 0,0000 | 0,0009 | 0,22 | 0,0000 | 0,0014 | 0,31 | 0,0000 | 0,0020 | 0,32 | 0,0000 | 0,0032 | 0,47 | 0,0000 | 0,0026 | 0,47 | 0,0000 | 0,0040 |
| S06- | Kindberg Dörfel | Allerheiligen Mürzhofen | 0,50 | 0,0000 | 0,0020 | 0,51 | 0,0000 | 0,0031 | 0,71 | 0,0000 | 0,0046 | 0,71 | 0,0000 | 0,0072 | 1,06 | 0,0000 | 0,0058 | 1,06 | 0,0000 | 0,0090 |
| S06- | Allerheiligen Mürzhofen | St. Marein | 0,76 | 0,0000 | 0,0030 | 0,76 | 0,0000 | 0,0047 | 1,06 | 0,0000 | 0,0069 | 1,07 | 0,0000 | 0,0108 | 1,59 | 0,0000 | 0,0086 | 1,60 | 0,0000 | 0,0136 |
| S06- | St. Marein | Kapfenberg | 0,54 | 0,0000 | 0,0021 | 0,54 | 0,0000 | 0,0033 | 0,75 | 0,0000 | 0,0049 | 0,76 | 0,0000 | 0,0076 | 1,13 | 0,0000 | 0,0061 | 1,13 | 0,0000 | 0,0096 |
| S06- | Kapfenberg | KN Bruck/Mur | 1,00 | 0,0000 | 0,0039 | 1,01 | 0,0000 | 0,0062 | 1,41 | 0,0000 | 0,0091 | 1,41 | 0,0000 | 0,0143 | 2,11 | 0,0000 | 0,0114 | 2,12 | 0,0000 | 0,0180 |
| S06- | KN Bruck/Mur | ASt Bruck/Mur | 0,86 | 0,0000 | 0,0034 | 0,86 | 0,0000 | 0,0053 | 1,21 | 0,0000 | 0,0078 | 1,21 | 0,0000 | 0,0122 | 1,81 | 0,0000 | 0,0098 | 1,82 | 0,0000 | 0,0154 |
| S06- | ASt Bruck/Mur | Niklasdorf | 0,80 | 0,0000 | 0,0031 | 0,80 | 0,0000 | 0,0049 | 1,12 | 0,0000 | 0,0072 | 1,12 | 0,0000 | 0,0113 | 1,67 | 0,0000 | 0,0091 | 1,68 | 0,0000 | 0,0143 |
| S06- | Niklasdorf | Leoben Ost | 0,85 | 0,0000 | 0,0033 | 0,85 | 0,0000 | 0,0052 | 1,19 | 0,0000 | 0,0077 | 1,20 | 0,0000 | 0,0121 | 1,78 | 0,0000 | 0,0097 | 1,79 | 0,0000 | 0,0152 |
| S06- | Leoben Ost | Leoben West | 0,95 | 0,0000 | 0,0037 | 0,95 | 0,0000 | 0,0059 | 1,33 | 0,0000 | 0,0086 | 1,34 | 0,0000 | 0,0135 | 2,00 | 0,0000 | 0,0108 | 2,00 | 0,0000 | 0,0170 |
| S06- | Leoben West | St. Michael | 0,90 | 0,0000 | 0,0035 | 0,90 | 0,0000 | 0,0056 | 1,27 | 0,0000 | 0,0082 | 1,27 | 0,0000 | 0,0128 | 1,90 | 0,0000 | 0,0103 | 1,90 | 0,0000 | 0,0162 |
| S06- | St. Michael | KN St. Michael | 0,27 | 0,0000 | 0,0011 | 0,27 | 0,0000 | 0,0017 | 0,39 | 0,0000 | 0,0025 | 0,39 | 0,0000 | 0,0039 | 0,58 | 0,0000 | 0,0031 | 0,58 | 0,0000 | 0,0049 |
| S10- | Unterweirdersdorf | Neumarkt | 1,19 | 0,0000 | 0,0047 | 1,19 | 0,0000 | 0,0074 | 1,67 | 0,0000 | 0,0108 | 1,68 | 0,0000 | 0,0169 | 2,51 | 0,0000 | 0,0136 | 2,51 | 0,0000 | 0,0214 |
| S10- | Neumarkt | Kefermarkt | 0,68 | 0,0000 | 0,0027 | 0,69 | 0,0000 | 0,0042 | 0,96 | 0,0000 | 0,0062 | 0,96 | 0,0000 | 0,0097 | 1,44 | 0,0000 | 0,0078 | 1,44 | 0,0000 | 0,0123 |
| S10- | Kefermarkt | Freistadt / Süd | 0,74 | 0,0000 | 0,0029 | 0,74 | 0,0000 | 0,0046 | 1,03 | 0,0000 | 0,0067 | 1,04 | 0,0000 | 0,0105 | 1,55 | 0,0000 | 0,0084 | 1,55 | 0,0000 | 0,0132 |
| S10- | Freistadt / Süd | Grünbach Sandl | 0,78 | 0,0000 | 0,0031 | 0,78 | 0,0000 | | | | | | | | | | | | | |

| | | | | | | | | | | | | | | | | | | | | |
|------|-----------------------------|-----------------------------|------|--------|--------|------|--------|--------|------|--------|--------|------|--------|--------|------|--------|--------|------|--------|--------|
| S31- | Eisenstadt Mitte | KN Eisenstadt | 0,34 | 0,0000 | 0,0013 | 0,34 | 0,0000 | 0,0021 | 0,48 | 0,0000 | 0,0031 | 0,48 | 0,0000 | 0,0048 | 0,71 | 0,0000 | 0,0039 | 0,71 | 0,0000 | 0,0061 |
| S31- | KN Eisenstadt | Wulkaprodersdorf | 0,45 | 0,0000 | 0,0018 | 0,45 | 0,0000 | 0,0028 | 0,63 | 0,0000 | 0,0041 | 0,63 | 0,0000 | 0,0064 | 0,95 | 0,0000 | 0,0051 | 0,95 | 0,0000 | 0,0081 |
| S31- | Wulkaprodersdorf | KN Mattersburg | 1,28 | 0,0000 | 0,0050 | 1,28 | 0,0000 | 0,0079 | 1,80 | 0,0000 | 0,0116 | 1,80 | 0,0000 | 0,0182 | 2,69 | 0,0000 | 0,0146 | 2,70 | 0,0000 | 0,0229 |
| S31- | KN Mattersburg | Forchtenstein | 0,93 | 0,0000 | 0,0036 | 0,93 | 0,0000 | 0,0057 | 1,30 | 0,0000 | 0,0084 | 1,30 | 0,0000 | 0,0132 | 1,95 | 0,0000 | 0,0106 | 1,95 | 0,0000 | 0,0166 |
| S31- | Forchtenstein | Siegraben | 1,29 | 0,0000 | 0,0051 | 1,30 | 0,0000 | 0,0080 | 1,82 | 0,0000 | 0,0117 | 1,82 | 0,0000 | 0,0184 | 2,72 | 0,0000 | 0,0148 | 2,73 | 0,0000 | 0,0232 |
| S31- | Siegraben | Weppersdorf/Kobersdorf | 1,56 | 0,0000 | 0,0061 | 1,56 | 0,0000 | 0,0096 | 2,19 | 0,0000 | 0,0141 | 2,20 | 0,0000 | 0,0222 | 3,28 | 0,0000 | 0,0178 | 3,29 | 0,0000 | 0,0279 |
| S31- | Weppersdorf/Kobersdorf | Weppersdorf/Markt St.Martin | 0,32 | 0,0000 | 0,0013 | 0,32 | 0,0000 | 0,0020 | 0,45 | 0,0000 | 0,0029 | 0,45 | 0,0000 | 0,0046 | 0,67 | 0,0000 | 0,0037 | 0,68 | 0,0000 | 0,0057 |
| S31- | Weppersdorf/Markt St.Martin | Neutal | 0,74 | 0,0000 | 0,0029 | 0,74 | 0,0000 | 0,0046 | 1,04 | 0,0000 | 0,0067 | 1,04 | 0,0000 | 0,0105 | 1,56 | 0,0000 | 0,0084 | 1,56 | 0,0000 | 0,0133 |
| S31- | Neutal | Stoob Süd | 0,65 | 0,0000 | 0,0025 | 0,65 | 0,0000 | 0,0040 | 0,91 | 0,0000 | 0,0058 | 0,91 | 0,0000 | 0,0092 | 1,36 | 0,0000 | 0,0074 | 1,36 | 0,0000 | 0,0116 |
| S31- | Stoob Süd | Oberpullendorf | 0,71 | 0,0000 | 0,0028 | 0,71 | 0,0000 | 0,0044 | 0,99 | 0,0000 | 0,0064 | 0,99 | 0,0000 | 0,0100 | 1,48 | 0,0000 | 0,0080 | 1,49 | 0,0000 | 0,0126 |
| S33- | KN St. Pölten | St. Pölten Ost | 0,38 | 0,0000 | 0,0015 | 0,38 | 0,0000 | 0,0024 | 0,54 | 0,0000 | 0,0035 | 0,54 | 0,0000 | 0,0054 | 0,81 | 0,0000 | 0,0044 | 0,81 | 0,0000 | 0,0069 |
| S33- | St. Pölten Ost | St. Pölten Nord | 0,68 | 0,0000 | 0,0027 | 0,68 | 0,0000 | 0,0042 | 0,95 | 0,0000 | 0,0061 | 0,95 | 0,0000 | 0,0096 | 1,42 | 0,0000 | 0,0077 | 1,43 | 0,0000 | 0,0121 |
| S33- | St. Pölten Nord | Herzogenburg Süd | 0,72 | 0,0000 | 0,0028 | 0,72 | 0,0000 | 0,0044 | 1,01 | 0,0000 | 0,0065 | 1,01 | 0,0000 | 0,0102 | 1,51 | 0,0000 | 0,0082 | 1,51 | 0,0000 | 0,0128 |
| S33- | Herzogenburg Süd | Herzogenburg Stadt | 0,38 | 0,0000 | 0,0015 | 0,38 | 0,0000 | 0,0024 | 0,54 | 0,0000 | 0,0035 | 0,54 | 0,0000 | 0,0054 | 0,80 | 0,0000 | 0,0044 | 0,81 | 0,0000 | 0,0069 |
| S33- | Herzogenburg Stadt | Herzogenburg Nord | 0,21 | 0,0000 | 0,0008 | 0,21 | 0,0000 | 0,0013 | 0,30 | 0,0000 | 0,0019 | 0,30 | 0,0000 | 0,0030 | 0,45 | 0,0000 | 0,0024 | 0,45 | 0,0000 | 0,0038 |
| S33- | Herzogenburg Nord | Traismauer Süd | 1,03 | 0,0000 | 0,0041 | 1,03 | 0,0000 | 0,0064 | 1,45 | 0,0000 | 0,0093 | 1,45 | 0,0000 | 0,0147 | 2,17 | 0,0000 | 0,0118 | 2,18 | 0,0000 | 0,0185 |
| S33- | Traismauer Süd | Traismauer Nord | 0,53 | 0,0000 | 0,0021 | 0,53 | 0,0000 | 0,0032 | 0,74 | 0,0000 | 0,0047 | 0,74 | 0,0000 | 0,0075 | 1,10 | 0,0000 | 0,0060 | 1,11 | 0,0000 | 0,0094 |
| S33- | Traismauer Nord | Jettsdorf | 0,89 | 0,0000 | 0,0035 | 0,89 | 0,0000 | 0,0055 | 1,24 | 0,0000 | 0,0080 | 1,25 | 0,0000 | 0,0126 | 1,87 | 0,0000 | 0,0101 | 1,87 | 0,0000 | 0,0159 |
| S35- | KN Bruck/Mur | Pernegg | 1,08 | 0,0000 | 0,0043 | 1,09 | 0,0000 | 0,0067 | 1,52 | 0,0000 | 0,0098 | 1,53 | 0,0000 | 0,0154 | 2,28 | 0,0000 | 0,0124 | 2,29 | 0,0000 | 0,0194 |
| S35- | Pernegg | Mixnitz/Mautstatt | 0,79 | 0,0000 | 0,0031 | 0,79 | 0,0000 | 0,0049 | 1,11 | 0,0000 | 0,0071 | 1,11 | 0,0000 | 0,0112 | 1,66 | 0,0000 | 0,0090 | 1,66 | 0,0000 | 0,0141 |
| S35- | Mixnitz/Mautstatt | Röthelstein | 0,95 | 0,0000 | 0,0037 | 0,95 | 0,0000 | 0,0058 | 1,33 | 0,0000 | 0,0085 | 1,33 | 0,0000 | 0,0134 | 1,99 | 0,0000 | 0,0108 | 1,99 | 0,0000 | 0,0169 |
| S35- | Röthelstein | Laufnitzdorf | 0,46 | 0,0000 | 0,0018 | 0,46 | 0,0000 | 0,0028 | 0,64 | 0,0000 | 0,0041 | 0,64 | 0,0000 | 0,0065 | 0,96 | 0,0000 | 0,0052 | 0,96 | 0,0000 | 0,0082 |
| S35- | Laufnitzdorf | Rothleiten | 0,52 | 0,0000 | 0,0020 | 0,52 | 0,0000 | 0,0032 | 0,73 | 0,0000 | 0,0047 | 0,73 | 0,0000 | 0,0074 | 1,09 | 0,0000 | 0,0059 | 1,09 | 0,0000 | 0,0093 |
| S35- | Rothleiten | Frohnleiten Nord | 0,32 | 0,0000 | 0,0013 | 0,32 | 0,0000 | 0,0020 | 0,45 | 0,0000 | 0,0029 | 0,45 | 0,0000 | 0,0046 | 0,68 | 0,0000 | 0,0037 | 0,68 | 0,0000 | 0,0058 |
| S35- | Frohnleiten Nord | Frohnleiten | 0,15 | 0,0000 | 0,0006 | 0,15 | 0,0000 | 0,0009 | 0,21 | 0,0000 | 0,0013 | 0,21 | 0,0000 | 0,0021 | 0,31 | 0,0000 | 0,0017 | 0,31 | 0,0000 | 0,0027 |
| S35- | Frohnleiten | Badl Peggau | 1,00 | 0,0000 | 0,0039 | 1,00 | 0,0000 | 0,0062 | 1,40 | 0,0000 | 0,0090 | 1,41 | 0,0000 | 0,0142 | 2,10 | 0,0000 | 0,0114 | 2,11 | 0,0000 | 0,0179 |
| S35- | Badl Peggau | Peggau Mitte | 0,33 | 0,0000 | 0,0013 | 0,34 | 0,0000 | 0,0021 | 0,47 | 0,0000 | 0,0030 | 0,47 | 0,0000 | 0,0048 | 0,70 | 0,0000 | 0,0038 | 0,71 | 0,0000 | 0,0060 |
| S35- | Peggau Mitte | KN Peggau Deutschfeistritz | 0,70 | 0,0000 | 0,0027 | 0,70 | 0,0000 | 0,0043 | 0,98 | 0,0000 | 0,0063 | 0,98 | 0,0000 | 0,0099 | 1,47 | 0,0000 | 0,0079 | 1,47 | 0,0000 | 0,0125 |
| S36- | KN St. Michael | St. Stefan ob Leoben | 0,57 | 0,0000 | 0,0023 | 0,58 | 0,0000 | 0,0035 | 0,81 | 0,0000 | 0,0052 | 0,81 | 0,0000 | 0,0082 | 1,21 | 0,0000 | 0,0065 | 1,21 | 0,0000 | 0,0103 |
| S36- | St. Stefan ob Leoben | Kraubath | 0,62 | 0,0000 | 0,0024 | 0,62 | 0,0000 | 0,0038 | 0,87 | 0,0000 | 0,0056 | 0,87 | 0,0000 | 0,0088 | 1,30 | 0,0000 | 0,0070 | 1,30 | 0,0000 | 0,0111 |
| S36- | Kraubath | Feistritz St. Lorenzen | 1,08 | 0,0000 | 0,0043 | 1,09 | 0,0000 | 0,0067 | 1,52 | 0,0000 | 0,0098 | 1,53 | 0,0000 | 0,0154 | 2,28 | 0,0000 | 0,0124 | 2,29 | 0,0000 | 0,0194 |
| S36- | Feistritz St. Lorenzen | Knittelfeld Ost | 1,24 | 0,0000 | 0,0049 | 1,25 | 0,0000 | 0,0077 | 1,75 | 0,0000 | 0,0112 | 1,75 | 0,0000 | 0,0177 | 2,62 | 0,0000 | 0,0142 | 2,62 | 0,0000 | 0,0223 |
| S36- | Knittelfeld Ost | Knittelfeld West | 0,53 | 0,0000 | 0,0021 | 0,53 | 0,0000 | 0,0033 | 0,74 | 0,0000 | 0,0048 | 0,74 | 0,0000 | 0,0075 | 1,11 | 0,0000 | 0,0060 | 1,11 | 0,0000 | 0,0095 |
| S36- | Knittelfeld West | Zeitweg Ost Spielberg | 0,16 | 0,0000 | 0,0006 | 0,17 | 0,0000 | 0,0010 | 0,23 | 0,0000 | 0,0015 | 0,23 | 0,0000 | 0,0023 | 0,35 | 0,0000 | 0,0019 | 0,35 | 0,0000 | 0,0030 |
| S36- | Zeitweg Ost Spielberg | Zeitweg West | 1,07 | 0,0000 | 0,0042 | 1,07 | 0,0000 | 0,0066 | 1,50 | 0,0000 | 0,0097 | 1,51 | 0,0000 | 0,0152 | 2,25 | 0,0000 | 0,0122 | 2,26 | 0,0000 | 0,0192 |
| S36- | Zeitweg West | Judenburg Ost Fohnsdorf | 0,54 | 0,0000 | 0,0021 | 0,54 | 0,0000 | 0,0033 | 0,76 | 0,0000 | 0,0049 | 0,76 | 0,0000 | 0,0077 | 1,13 | 0,0000 | 0,0061 | 1,14 | 0,0000 | 0,0097 |
| S36- | Judenburg Ost Fohnsdorf | Judenburg West | 0,84 | 0,0000 | 0,0033 | 0,84 | 0,0000 | 0,0052 | 1,17 | 0,0000 | 0,0076 | 1,18 | 0,0000 | 0,0119 | 1,76 | 0,0000 | 0,0095 | 1,76 | 0,0000 | 0,0150 |
| S36- | As B317 (prov.) | St. Georgen Ost | 0,09 | 0,0000 | 0,0003 | 0,09 | 0,0000 | 0,0005 | 0,12 | 0,0000 | 0,0008 | 0,12 | 0,0000 | 0,0012 | 0,18 | 0,0000 | 0,0010 | 0,18 | 0,0000 | 0,0016 |
| S36- | St. Georgen Ost | St. Georgen West | 0,16 | 0,0000 | 0,0006 | 0,16 | 0,0000 | 0,0010 | 0,23 | 0,0000 | 0,0015 | 0,23 | 0,0000 | 0,0023 | 0,34 | 0,0000 | 0,0018 | 0,34 | 0,0000 | 0,0029 |
| S37- | St. Veit Nord | St. Veit Mitte / Brückl | 0,51 | 0,0000 | 0,0020 | 0,51 | 0,0000 | 0,0031 | 0,71 | 0,0000 | 0,0046 | 0,71 | 0,0000 | 0,0072 | 1,07 | 0,0000 | 0,0058 | 1,07 | 0,0000 | 0,0091 |
| S37- | St. Veit Mitte / Brückl | St. Veit Süd | 0,43 | 0,0000 | 0,0017 | 0,43 | 0,0000 | 0,0027 | 0,60 | 0,0000 | 0,0039 | 0,61 | 0,0000 | 0,0061 | 0,91 | 0,0000 | 0,0049 | 0,91 | 0,0000 | 0,0077 |
| S37- | St. Veit Süd | St. Veit Industriegebiet | 0,32 | 0,0000 | 0,0013 | 0,32 | 0,0000 | 0,0020 | 0,45 | 0,0000 | 0,0029 | 0,46 | 0,0000 | 0,0046 | 0,68 | 0,0000 | 0,0037 | 0,68 | 0,0000 | 0,0058 |
| S37- | St. Veit Industriegebiet | Maria Saal | 1,14 | 0,0000 | 0,0045 | 1,14 | 0,0000 | 0,0070 | 1,60 | 0,0000 | 0,0103 | 1,60 | 0,0000 | 0,0162 | 2,39 | 0,0000 | 0,0130 | 2,40 | 0,0000 | 0,0204 |
| S37- | Maria Saal | Karnburg | 0,41 | 0,0000 | 0,0016 | 0,41 | 0,0000 | 0,0025 | 0,57 | 0,0000 | 0,0037 | 0,57 | 0,0000 | 0,0058 | 0,85 | 0,0000 | 0,0046 | 0,86 | 0,0000 | 0,0073 |
| S37- | Karnburg | Klagenfurt Nord | 0,35 | 0,0000 | 0,0014 | 0,36 | 0,0000 | 0,0022 | 0,50 | 0,0000 | 0,0032 | 0,50 | 0,0000 | 0,0050 | 0,75 | 0,0000 | 0,0040 | 0,75 | 0,0000 | 0,0064 |
| A01- | Preßbaum | Wien Auhof | 2,48 | 0,0000 | 0,0098 | 2,49 | 0,0000 | 0,0153 | 3,48 | 0,0000 | 0,0224 | 3,49 | 0,0000 | 0,0352 | 5,21 | 0,0000 | 0,0283 | 5,23 | 0,0000 | 0,0444 |
| A01- | KN Steinhäusl | Preßbaum | 1,40 | 0,0000 | 0,0055 | 1,40 | 0,0000 | 0,0087 | 1,97 | 0,0000 | 0,0127 | 1,97 | 0,0000 | 0,0199 | 2,95 | 0,0000 | 0,0160 | 2,96 | 0,0000 | 0,0251 |
| A01- | Altlenzbach | KN Steinhäusl | 0,82 | 0,0000 | 0,0032 | 0,83 | 0,0000 | 0,0051 | 1,16 | 0,0000 | 0,0075 | 1,16 | 0,0000 | 0,0117 | 1,73 | 0,0000 | 0,0094 | 1,74 | 0,0000 | 0,0148 |
| A01- | St. Christophen | Altlenzbach | 0,98 | 0,0000 | 0,0039 | 0,98 | 0,0000 | 0,0061 | 1,38 | 0,0000 | 0,0089 | 1,38 | 0,0000 | 0,0140 | 2,07 | 0,0000 | 0,0112 | 2,07 | 0,0000 | 0,0176 |
| A01- | Böheimkirchen | St. Christophen | 1,18 | 0,0000 | 0,0046 | 1,18 | 0,0000 | 0,0073 | 1,65 | 0,0000 | 0,0107 | 1,66 | 0,0000 | 0,0167 | 2,48 | 0,0000 | 0,0134 | 2,49 | 0,0000 | 0,0211 |
| A01- | KN St. Pölten | Böheimkirchen | 1,15 | 0,0000 | 0,0045 | 1,16 | 0,0000 | 0,0071 | 1,62 | 0,0000 | 0,0104 | 1,62 | 0,0000 | 0,0164 | 2,42 | 0,0000 | 0,0131 | 2,43 | 0,0000 | 0,0207 |
| A01- | St. Pölten Süd | KN St. Pölten | 0,82 | 0,0000 | 0,0032 | 0,82 | 0,0000 | 0,0051 | 1,15 | 0,0000 | 0,0074 | 1,15 | 0,0000 | 0,0116 | 1,72 | 0,0000 | 0,0093 | 1,72 | 0,0000 | 0,0147 |
| A01- | Loosdorf | St. Pölten Süd | 2,84 | 0,0000 | 0,0111 | 2,84 | 0,0000 | 0,0175 | 3,98 | 0,0000 | 0,0256 | 3,99 | 0,0000 | 0,0403 | 5,96 | 0,0000 | 0,0323 | 5,98 | 0,0000 | 0,0508 |
| A01- | Melk | Loosdorf | 1,04 | 0,0000 | 0,0041 | 1,04 | 0,0000 | 0,0064 | 1,46 | 0,0000 | 0,0094 | 1,46 | 0,0000 | 0,0148 | 2,18 | 0,0000 | 0,0118 | 2,19 | 0,0000 | 0,0186 |
| A01- | Pöchlarn | Melk | 1,84 | 0,0000 | 0,0072 | 1,85 | 0,0000 | 0,0114 | 2,58 | 0,0000 | 0,0167 | 2,59 | 0,0000 | 0,0262 | 3,87 | 0,0000 | 0,0210 | 3,89 | 0,0000 | 0,0330 |
| A01- | Ybbs Wieselburg | Pöchlarn | 1,70 | 0,0000 | 0,0067 | 1,70 | 0,0000 | 0,0105 | 2,39 | 0,0000 | 0,0154 | 2,39 | 0,0000 | 0,0242 | 3,57 | 0,0000 | 0,0194 | 3,59 | 0,0000 | 0,0305 |
| A01- | Amstetten Ost | Ybbs Wieselburg | 1,53 | 0,0000 | | | | | | | | | | | | | | | | |

| | | | | | | | | | | | | | | | | | | | | |
|------|----------------------------|----------------------------|------|--------|--------|------|--------|--------|------|--------|--------|------|--------|--------|------|--------|--------|------|--------|--------|
| A01- | Laakirchen West | Laakirchen Ost | 0,64 | 0,0000 | 0,0025 | 0,65 | 0,0000 | 0,0040 | 0,90 | 0,0000 | 0,0058 | 0,91 | 0,0000 | 0,0092 | 1,36 | 0,0000 | 0,0073 | 1,36 | 0,0000 | 0,0115 |
| A01- | Regau | Laakirchen West | 1,26 | 0,0000 | 0,0050 | 1,27 | 0,0000 | 0,0078 | 1,77 | 0,0000 | 0,0114 | 1,78 | 0,0000 | 0,0180 | 2,66 | 0,0000 | 0,0144 | 2,66 | 0,0000 | 0,0226 |
| A01- | Schörfling | Regau | 1,66 | 0,0000 | 0,0065 | 1,66 | 0,0000 | 0,0103 | 2,33 | 0,0000 | 0,0150 | 2,34 | 0,0000 | 0,0236 | 3,49 | 0,0000 | 0,0189 | 3,50 | 0,0000 | 0,0297 |
| A01- | Seewalchen | Schörfling | 0,26 | 0,0000 | 0,0010 | 0,26 | 0,0000 | 0,0016 | 0,36 | 0,0000 | 0,0023 | 0,36 | 0,0000 | 0,0037 | 0,54 | 0,0000 | 0,0029 | 0,54 | 0,0000 | 0,0046 |
| A01- | St. Georgen | Seewalchen | 1,50 | 0,0000 | 0,0059 | 1,51 | 0,0000 | 0,0093 | 2,11 | 0,0000 | 0,0136 | 2,12 | 0,0000 | 0,0214 | 3,16 | 0,0000 | 0,0172 | 3,17 | 0,0000 | 0,0270 |
| A01- | Oberwang | St. Georgen | 2,01 | 0,0000 | 0,0079 | 2,01 | 0,0000 | 0,0124 | 2,82 | 0,0000 | 0,0181 | 2,83 | 0,0000 | 0,0285 | 4,22 | 0,0000 | 0,0229 | 4,23 | 0,0000 | 0,0360 |
| A01- | Mondsee | Oberwang | 1,85 | 0,0000 | 0,0073 | 1,85 | 0,0000 | 0,0114 | 2,59 | 0,0000 | 0,0167 | 2,60 | 0,0000 | 0,0262 | 3,88 | 0,0000 | 0,0211 | 3,90 | 0,0000 | 0,0331 |
| A01- | Thalgau | Mondsee | 1,70 | 0,0000 | 0,0067 | 1,71 | 0,0000 | 0,0105 | 2,39 | 0,0000 | 0,0154 | 2,40 | 0,0000 | 0,0242 | 3,58 | 0,0000 | 0,0194 | 3,59 | 0,0000 | 0,0305 |
| A01- | Wallersee | Thalgau | 1,30 | 0,0000 | 0,0051 | 1,30 | 0,0000 | 0,0080 | 1,82 | 0,0000 | 0,0117 | 1,83 | 0,0000 | 0,0184 | 2,73 | 0,0000 | 0,0148 | 2,74 | 0,0000 | 0,0232 |
| A01- | Salzburg Nord | Wallersee | 1,26 | 0,0000 | 0,0049 | 1,26 | 0,0000 | 0,0078 | 1,76 | 0,0000 | 0,0114 | 1,77 | 0,0000 | 0,0178 | 2,64 | 0,0000 | 0,0143 | 2,65 | 0,0000 | 0,0225 |
| A01- | Salzburg Bergheim-West | Salzburg Nord | 0,28 | 0,0000 | 0,0011 | 0,28 | 0,0000 | 0,0017 | 0,40 | 0,0000 | 0,0026 | 0,40 | 0,0000 | 0,0040 | 0,60 | 0,0000 | 0,0032 | 0,60 | 0,0000 | 0,0051 |
| A01- | Messe | Salzburg Bergheim-West | 0,14 | 0,0000 | 0,0005 | 0,14 | 0,0000 | 0,0008 | 0,19 | 0,0000 | 0,0012 | 0,19 | 0,0000 | 0,0019 | 0,28 | 0,0000 | 0,0015 | 0,29 | 0,0000 | 0,0024 |
| A01- | Salzburg Mitte Freilassing | Messe | 0,18 | 0,0000 | 0,0007 | 0,18 | 0,0000 | 0,0011 | 0,25 | 0,0000 | 0,0016 | 0,25 | 0,0000 | 0,0026 | 0,38 | 0,0000 | 0,0021 | 0,38 | 0,0000 | 0,0032 |
| A01- | Kleßheim | Salzburg Mitte Freilassing | 0,22 | 0,0000 | 0,0009 | 0,22 | 0,0000 | 0,0014 | 0,31 | 0,0000 | 0,0020 | 0,31 | 0,0000 | 0,0031 | 0,47 | 0,0000 | 0,0025 | 0,47 | 0,0000 | 0,0040 |
| A01- | Siezenheim | Kleßheim | 0,31 | 0,0000 | 0,0012 | 0,31 | 0,0000 | 0,0019 | 0,43 | 0,0000 | 0,0028 | 0,43 | 0,0000 | 0,0044 | 0,65 | 0,0000 | 0,0035 | 0,65 | 0,0000 | 0,0055 |
| A01- | Flughafen | Siezenheim | 0,15 | 0,0000 | 0,0006 | 0,15 | 0,0000 | 0,0010 | 0,22 | 0,0000 | 0,0014 | 0,22 | 0,0000 | 0,0022 | 0,32 | 0,0000 | 0,0018 | 0,33 | 0,0000 | 0,0028 |
| A01- | Wals Salzburg West | Flughafen | 0,19 | 0,0000 | 0,0007 | 0,19 | 0,0000 | 0,0012 | 0,26 | 0,0000 | 0,0017 | 0,27 | 0,0000 | 0,0027 | 0,40 | 0,0000 | 0,0021 | 0,40 | 0,0000 | 0,0034 |
| A01- | KN Salzburg | Wals Salzburg West | 0,28 | 0,0000 | 0,0011 | 0,28 | 0,0000 | 0,0017 | 0,40 | 0,0000 | 0,0026 | 0,40 | 0,0000 | 0,0040 | 0,59 | 0,0000 | 0,0032 | 0,60 | 0,0000 | 0,0051 |
| A01- | Staatsgrenze Walsberg | KN Salzburg | 0,48 | 0,0000 | 0,0019 | 0,48 | 0,0000 | 0,0030 | 0,67 | 0,0000 | 0,0043 | 0,68 | 0,0000 | 0,0068 | 1,01 | 0,0000 | 0,0055 | 1,01 | 0,0000 | 0,0086 |
| A02- | KN Vösendorf | KN Wien Inzersdorf | 0,60 | 0,0000 | 0,0024 | 0,60 | 0,0000 | 0,0037 | 0,84 | 0,0000 | 0,0054 | 0,85 | 0,0000 | 0,0085 | 1,26 | 0,0000 | 0,0068 | 1,27 | 0,0000 | 0,0108 |
| A02- | Mödling | KN Vösendorf | 0,41 | 0,0000 | 0,0016 | 0,41 | 0,0000 | 0,0025 | 0,57 | 0,0000 | 0,0037 | 0,57 | 0,0000 | 0,0058 | 0,86 | 0,0000 | 0,0047 | 0,86 | 0,0000 | 0,0073 |
| A02- | Wr. Neudorf | Mödling | 0,39 | 0,0000 | 0,0015 | 0,39 | 0,0000 | 0,0024 | 0,55 | 0,0000 | 0,0035 | 0,55 | 0,0000 | 0,0055 | 0,82 | 0,0000 | 0,0044 | 0,82 | 0,0000 | 0,0070 |
| A02- | Wr. Neudorf IZ/Süd | Wr. Neudorf | 0,43 | 0,0000 | 0,0017 | 0,43 | 0,0000 | 0,0026 | 0,60 | 0,0000 | 0,0039 | 0,60 | 0,0000 | 0,0061 | 0,90 | 0,0000 | 0,0049 | 0,90 | 0,0000 | 0,0077 |
| A02- | KN Guntramsdorf | Wr. Neudorf IZ/Süd | 0,62 | 0,0000 | 0,0025 | 0,63 | 0,0000 | 0,0039 | 0,88 | 0,0000 | 0,0056 | 0,88 | 0,0000 | 0,0089 | 1,31 | 0,0000 | 0,0071 | 1,32 | 0,0000 | 0,0112 |
| A02- | Traiskirchen | KN Guntramsdorf | 0,69 | 0,0000 | 0,0027 | 0,70 | 0,0000 | 0,0043 | 0,98 | 0,0000 | 0,0063 | 0,98 | 0,0000 | 0,0099 | 1,46 | 0,0000 | 0,0079 | 1,47 | 0,0000 | 0,0125 |
| A02- | Baden | Traiskirchen | 0,39 | 0,0000 | 0,0015 | 0,39 | 0,0000 | 0,0024 | 0,54 | 0,0000 | 0,0035 | 0,54 | 0,0000 | 0,0055 | 0,81 | 0,0000 | 0,0044 | 0,82 | 0,0000 | 0,0069 |
| A02- | Bad Vöslau | Baden | 0,64 | 0,0000 | 0,0025 | 0,64 | 0,0000 | 0,0039 | 0,89 | 0,0000 | 0,0057 | 0,90 | 0,0000 | 0,0090 | 1,34 | 0,0000 | 0,0072 | 1,34 | 0,0000 | 0,0114 |
| A02- | Kottingbrunn | Bad Vöslau | 0,46 | 0,0000 | 0,0018 | 0,46 | 0,0000 | 0,0028 | 0,64 | 0,0000 | 0,0042 | 0,65 | 0,0000 | 0,0065 | 0,97 | 0,0000 | 0,0052 | 0,97 | 0,0000 | 0,0082 |
| A02- | Leobersdorf | Kottingbrunn | 0,40 | 0,0000 | 0,0016 | 0,40 | 0,0000 | 0,0025 | 0,57 | 0,0000 | 0,0036 | 0,57 | 0,0000 | 0,0057 | 0,85 | 0,0000 | 0,0046 | 0,85 | 0,0000 | 0,0072 |
| A02- | Wöllersdorf | Leobersdorf | 1,61 | 0,0000 | 0,0063 | 1,61 | 0,0000 | 0,0099 | 2,25 | 0,0000 | 0,0145 | 2,26 | 0,0000 | 0,0228 | 3,38 | 0,0000 | 0,0183 | 3,39 | 0,0000 | 0,0288 |
| A02- | Wr. Neustadt West | Wöllersdorf | 1,04 | 0,0000 | 0,0041 | 1,05 | 0,0000 | 0,0064 | 1,46 | 0,0000 | 0,0094 | 1,47 | 0,0000 | 0,0148 | 2,19 | 0,0000 | 0,0119 | 2,20 | 0,0000 | 0,0187 |
| A02- | KN Wr. Neustadt | Wr. Neustadt West | 0,42 | 0,0000 | 0,0016 | 0,42 | 0,0000 | 0,0026 | 0,59 | 0,0000 | 0,0038 | 0,59 | 0,0000 | 0,0059 | 0,88 | 0,0000 | 0,0048 | 0,88 | 0,0000 | 0,0075 |
| A02- | KN Seebenstein | KN Wr. Neustadt | 1,89 | 0,0000 | 0,0074 | 1,89 | 0,0000 | 0,0117 | 2,65 | 0,0000 | 0,0171 | 2,66 | 0,0000 | 0,0269 | 3,98 | 0,0000 | 0,0216 | 3,99 | 0,0000 | 0,0339 |
| A02- | Grimmenstein | KN Seebenstein | 1,61 | 0,0000 | 0,0063 | 1,62 | 0,0000 | 0,0100 | 2,26 | 0,0000 | 0,0146 | 2,27 | 0,0000 | 0,0229 | 3,39 | 0,0000 | 0,0184 | 3,40 | 0,0000 | 0,0289 |
| A02- | Edlitz | Grimmenstein | 0,45 | 0,0000 | 0,0018 | 0,45 | 0,0000 | 0,0028 | 0,63 | 0,0000 | 0,0040 | 0,63 | 0,0000 | 0,0063 | 0,94 | 0,0000 | 0,0051 | 0,94 | 0,0000 | 0,0080 |
| A02- | Krumbach | Edlitz | 1,38 | 0,0000 | 0,0054 | 1,38 | 0,0000 | 0,0085 | 1,94 | 0,0000 | 0,0125 | 1,94 | 0,0000 | 0,0196 | 2,90 | 0,0000 | 0,0157 | 2,91 | 0,0000 | 0,0247 |
| A02- | Zöbern | Krumbach | 0,73 | 0,0000 | 0,0029 | 0,73 | 0,0000 | 0,0045 | 1,02 | 0,0000 | 0,0066 | 1,03 | 0,0000 | 0,0103 | 1,53 | 0,0000 | 0,0083 | 1,54 | 0,0000 | 0,0130 |
| A02- | Aspang | Zöbern | 0,10 | 0,0000 | 0,0004 | 0,10 | 0,0000 | 0,0006 | 0,13 | 0,0000 | 0,0009 | 0,13 | 0,0000 | 0,0014 | 0,20 | 0,0000 | 0,0011 | 0,20 | 0,0000 | 0,0017 |
| A02- | Schäftern | Aspang | 1,15 | 0,0000 | 0,0045 | 1,15 | 0,0000 | 0,0071 | 1,62 | 0,0000 | 0,0104 | 1,62 | 0,0000 | 0,0164 | 2,42 | 0,0000 | 0,0131 | 2,43 | 0,0000 | 0,0206 |
| A02- | Pinggau/Friedberg | Schäftern | 1,38 | 0,0000 | 0,0054 | 1,38 | 0,0000 | 0,0085 | 1,93 | 0,0000 | 0,0124 | 1,94 | 0,0000 | 0,0195 | 2,89 | 0,0000 | 0,0157 | 2,90 | 0,0000 | 0,0246 |
| A02- | Pinkafeld | Pinggau/Friedberg | 0,93 | 0,0000 | 0,0037 | 0,93 | 0,0000 | 0,0058 | 1,31 | 0,0000 | 0,0084 | 1,31 | 0,0000 | 0,0132 | 1,96 | 0,0000 | 0,0106 | 1,97 | 0,0000 | 0,0167 |
| A02- | Lafnitzal/Oberwart | Pinkafeld | 1,94 | 0,0000 | 0,0076 | 1,95 | 0,0000 | 0,0120 | 2,73 | 0,0000 | 0,0176 | 2,74 | 0,0000 | 0,0276 | 4,08 | 0,0000 | 0,0221 | 4,10 | 0,0000 | 0,0348 |
| A02- | Hartberg | Lafnitzal/Oberwart | 0,77 | 0,0000 | 0,0030 | 0,77 | 0,0000 | 0,0047 | 1,08 | 0,0000 | 0,0069 | 1,08 | 0,0000 | 0,0109 | 1,61 | 0,0000 | 0,0087 | 1,62 | 0,0000 | 0,0137 |
| A02- | Sebersdorf/Bad Waltersdorf | Hartberg | 1,94 | 0,0000 | 0,0076 | 1,94 | 0,0000 | 0,0120 | 2,72 | 0,0000 | 0,0175 | 2,73 | 0,0000 | 0,0276 | 4,08 | 0,0000 | 0,0221 | 4,09 | 0,0000 | 0,0348 |
| A02- | Ilz Fürstenfeld | Sebersdorf/Bad Waltersdorf | 2,18 | 0,0000 | 0,0086 | 2,18 | 0,0000 | 0,0134 | 3,05 | 0,0000 | 0,0197 | 3,06 | 0,0000 | 0,0309 | 4,57 | 0,0000 | 0,0248 | 4,59 | 0,0000 | 0,0390 |
| A02- | Sinabelkirchen | Ilz Fürstenfeld | 2,00 | 0,0000 | 0,0079 | 2,00 | 0,0000 | 0,0124 | 2,81 | 0,0000 | 0,0181 | 2,82 | 0,0000 | 0,0284 | 4,21 | 0,0000 | 0,0228 | 4,22 | 0,0000 | 0,0358 |
| A02- | Gleisdorf Süd | Sinabelkirchen | 1,32 | 0,0000 | 0,0052 | 1,32 | 0,0000 | 0,0081 | 1,85 | 0,0000 | 0,0119 | 1,86 | 0,0000 | 0,0187 | 2,77 | 0,0000 | 0,0150 | 2,78 | 0,0000 | 0,0236 |
| A02- | Gleisdorf West | Gleisdorf Süd | 0,57 | 0,0000 | 0,0022 | 0,57 | 0,0000 | 0,0035 | 0,80 | 0,0000 | 0,0052 | 0,81 | 0,0000 | 0,0081 | 1,20 | 0,0000 | 0,0065 | 1,21 | 0,0000 | 0,0102 |
| A02- | Laßnitzhöhe | Gleisdorf West | 1,50 | 0,0000 | 0,0059 | 1,50 | 0,0000 | 0,0093 | 2,10 | 0,0000 | 0,0135 | 2,11 | 0,0000 | 0,0213 | 3,15 | 0,0000 | 0,0171 | 3,16 | 0,0000 | 0,0268 |
| A02- | KN Graz Ost | Laßnitzhöhe | 1,87 | 0,0000 | 0,0074 | 1,88 | 0,0000 | 0,0116 | 2,63 | 0,0000 | 0,0170 | 2,64 | 0,0000 | 0,0266 | 3,94 | 0,0000 | 0,0214 | 3,95 | 0,0000 | 0,0336 |
| A02- | Graz Feldkirchen Flughafen | KN Graz Ost | 0,67 | 0,0000 | 0,0027 | 0,68 | 0,0000 | 0,0042 | 0,95 | 0,0000 | 0,0061 | 0,95 | 0,0000 | 0,0096 | 1,42 | 0,0000 | 0,0077 | 1,42 | 0,0000 | 0,0121 |
| A02- | KN Graz West | Graz Feldkirchen Flughafen | 0,45 | 0,0000 | 0,0018 | 0,45 | 0,0000 | 0,0028 | 0,63 | 0,0000 | 0,0041 | 0,64 | 0,0000 | 0,0064 | 0,95 | 0,0000 | 0,0051 | 0,95 | 0,0000 | 0,0081 |
| A02- | Unterprenstätten | KN Graz West | 0,54 | 0,0000 | 0,0021 | 0,54 | 0,0000 | 0,0034 | 0,76 | 0,0000 | 0,0049 | 0,76 | 0,0000 | 0,0077 | 1,14 | 0,0000 | 0,0062 | 1,14 | 0,0000 | 0,0097 |
| A02- | Lieboch | Unterprenstätten | 0,84 | 0,0000 | 0,0033 | 0,84 | 0,0000 | 0,0052 | 1,18 | 0,0000 | 0,0076 | 1,19 | 0,0000 | 0,0120 | 1,77 | 0,0000 | 0,0096 | 1,78 | 0,0000 | 0,0151 |
| A02- | Mooskirchen | Lieboch | 1,16 | 0,0000 | 0,0046 | 1,16 | 0,0000 | 0,0072 | 1,63 | 0,0000 | 0,0105 | 1,64 | 0,0000 | 0,0165 | 2,44 | 0,0000 | 0,0133 | 2,45 | 0,0000 | 0,0208 |
| A02- | Steinberg | Mooskirchen | 1,20 | 0,0000 | 0,0047 | 1,21 | 0,0000 | 0,0074 | 1,69 | 0,0000 | 0,0109 | 1,69 | 0,0000 | 0,0171 | 2,53 | 0,0000 | 0,0137 | 2,54 | 0,0000 | 0,0216 |
| A02- | Modriach | Steinberg | 3,01 | 0,0000 | 0,0118 | 3,01 | 0,0000 | 0,0186 | 4,22 | 0,0000 | 0,0272 | 4,24 | | | | | | | | |

| | | | | | | | | | | | | | | | | | | | | |
|------|----------------------------------|----------------------------------|------|--------|--------|------|--------|--------|------|--------|--------|------|--------|--------|------|--------|--------|------|--------|--------|
| A02- | Velden West | Velden Ost | 0,66 | 0,0000 | 0,0026 | 0,67 | 0,0000 | 0,0041 | 0,93 | 0,0000 | 0,0060 | 0,94 | 0,0000 | 0,0094 | 1,40 | 0,0000 | 0,0076 | 1,40 | 0,0000 | 0,0119 |
| A02- | Wernberg | Velden West | 1,10 | 0,0000 | 0,0043 | 1,10 | 0,0000 | 0,0068 | 1,54 | 0,0000 | 0,0099 | 1,55 | 0,0000 | 0,0156 | 2,31 | 0,0000 | 0,0125 | 2,32 | 0,0000 | 0,0197 |
| A02- | KN Villach | Wernberg | 0,58 | 0,0000 | 0,0023 | 0,59 | 0,0000 | 0,0036 | 0,82 | 0,0000 | 0,0053 | 0,82 | 0,0000 | 0,0083 | 1,23 | 0,0000 | 0,0067 | 1,23 | 0,0000 | 0,0105 |
| A02- | Villach Faaker See | KN Villach | 0,45 | 0,0000 | 0,0018 | 0,45 | 0,0000 | 0,0028 | 0,64 | 0,0000 | 0,0041 | 0,64 | 0,0000 | 0,0065 | 0,95 | 0,0000 | 0,0052 | 0,96 | 0,0000 | 0,0081 |
| A02- | Villach Warmbad | Villach Faaker See | 1,04 | 0,0000 | 0,0041 | 1,04 | 0,0000 | 0,0064 | 1,46 | 0,0000 | 0,0094 | 1,46 | 0,0000 | 0,0147 | 2,18 | 0,0000 | 0,0118 | 2,19 | 0,0000 | 0,0186 |
| A02- | Hermagor | Villach Warmbad | 1,88 | 0,0000 | 0,0074 | 1,88 | 0,0000 | 0,0116 | 2,64 | 0,0000 | 0,0170 | 2,65 | 0,0000 | 0,0267 | 3,95 | 0,0000 | 0,0214 | 3,97 | 0,0000 | 0,0337 |
| A02- | Arnoldstein | Hermagor | 0,45 | 0,0000 | 0,0018 | 0,45 | 0,0000 | 0,0028 | 0,63 | 0,0000 | 0,0040 | 0,63 | 0,0000 | 0,0064 | 0,94 | 0,0000 | 0,0051 | 0,94 | 0,0000 | 0,0080 |
| A02- | Staatsgrenze Arnoldstein | Arnoldstein | 0,69 | 0,0000 | 0,0027 | 0,69 | 0,0000 | 0,0042 | 0,96 | 0,0000 | 0,0062 | 0,97 | 0,0000 | 0,0098 | 1,44 | 0,0000 | 0,0078 | 1,45 | 0,0000 | 0,0123 |
| A03- | Münchendorf/Achau | KN Guntramsdorf | 0,18 | 0,0000 | 0,0007 | 0,18 | 0,0000 | 0,0011 | 0,25 | 0,0000 | 0,0016 | 0,25 | 0,0000 | 0,0025 | 0,37 | 0,0000 | 0,0020 | 0,38 | 0,0000 | 0,0032 |
| A03- | Ebreichsdorf Nord | Münchendorf/Achau | 0,75 | 0,0000 | 0,0029 | 0,75 | 0,0000 | 0,0046 | 1,05 | 0,0000 | 0,0068 | 1,06 | 0,0000 | 0,0107 | 1,58 | 0,0000 | 0,0086 | 1,58 | 0,0000 | 0,0134 |
| A03- | Ebreichsdorf West | Ebreichsdorf Nord | 0,61 | 0,0000 | 0,0024 | 0,61 | 0,0000 | 0,0038 | 0,86 | 0,0000 | 0,0055 | 0,86 | 0,0000 | 0,0087 | 1,29 | 0,0000 | 0,0070 | 1,29 | 0,0000 | 0,0110 |
| A03- | Pottendorf | Ebreichsdorf West | 0,80 | 0,0000 | 0,0032 | 0,81 | 0,0000 | 0,0050 | 1,13 | 0,0000 | 0,0073 | 1,13 | 0,0000 | 0,0114 | 1,69 | 0,0000 | 0,0092 | 1,69 | 0,0000 | 0,0144 |
| A03- | Hornstein | Pottendorf | 1,32 | 0,0000 | 0,0052 | 1,32 | 0,0000 | 0,0082 | 1,85 | 0,0000 | 0,0119 | 1,86 | 0,0000 | 0,0187 | 2,77 | 0,0000 | 0,0150 | 2,78 | 0,0000 | 0,0236 |
| A03- | Müllendorf | Hornstein | 0,86 | 0,0000 | 0,0034 | 0,87 | 0,0000 | 0,0053 | 1,21 | 0,0000 | 0,0078 | 1,22 | 0,0000 | 0,0123 | 1,82 | 0,0000 | 0,0099 | 1,82 | 0,0000 | 0,0155 |
| A03- | KN Eisenstadt | Müllendorf | 0,72 | 0,0000 | 0,0028 | 0,72 | 0,0000 | 0,0045 | 1,01 | 0,0000 | 0,0065 | 1,02 | 0,0000 | 0,0103 | 1,52 | 0,0000 | 0,0082 | 1,52 | 0,0000 | 0,0129 |
| A031 | Siegersdorf | KN Eisenstadt | 0,57 | 0,0000 | 0,0022 | 0,57 | 0,0000 | 0,0035 | 0,80 | 0,0000 | 0,0052 | 0,80 | 0,0000 | 0,0081 | 1,20 | 0,0000 | 0,0065 | 1,20 | 0,0000 | 0,0102 |
| A041 | KN Wien Prater | Stadionbrücke | 0,10 | 0,0000 | 0,0004 | 0,10 | 0,0000 | 0,0006 | 0,15 | 0,0000 | 0,0009 | 0,15 | 0,0000 | 0,0015 | 0,22 | 0,0000 | 0,0012 | 0,22 | 0,0000 | 0,0019 |
| A04- | Wien Simmeringer Haide | KN Wien Prater | 0,72 | 0,0000 | 0,0028 | 0,72 | 0,0000 | 0,0045 | 1,01 | 0,0000 | 0,0065 | 1,02 | 0,0000 | 0,0103 | 1,52 | 0,0000 | 0,0082 | 1,52 | 0,0000 | 0,0129 |
| A04- | KN Schwechat | Wien Simmeringer Haide | 0,65 | 0,0000 | 0,0025 | 0,65 | 0,0000 | 0,0040 | 0,91 | 0,0000 | 0,0059 | 0,91 | 0,0000 | 0,0092 | 1,36 | 0,0000 | 0,0074 | 1,37 | 0,0000 | 0,0116 |
| A04- | Flughafen Wien Schwechat | KN Schwechat | 0,94 | 0,0000 | 0,0037 | 0,94 | 0,0000 | 0,0058 | 1,31 | 0,0000 | 0,0085 | 1,32 | 0,0000 | 0,0133 | 1,97 | 0,0000 | 0,0107 | 1,97 | 0,0000 | 0,0168 |
| A04- | Fischamend | Flughafen Wien Schwechat | 1,05 | 0,0000 | 0,0041 | 1,05 | 0,0000 | 0,0065 | 1,47 | 0,0000 | 0,0095 | 1,48 | 0,0000 | 0,0149 | 2,20 | 0,0000 | 0,0120 | 2,21 | 0,0000 | 0,0188 |
| A04- | Bruck/Leitha West | Fischamend | 2,30 | 0,0000 | 0,0090 | 2,30 | 0,0000 | 0,0142 | 3,23 | 0,0000 | 0,0208 | 3,24 | 0,0000 | 0,0327 | 4,83 | 0,0000 | 0,0262 | 4,85 | 0,0000 | 0,0412 |
| A04- | Bruck/Leitha Ost | Bruck/Leitha West | 0,76 | 0,0000 | 0,0030 | 0,77 | 0,0000 | 0,0047 | 1,07 | 0,0000 | 0,0069 | 1,08 | 0,0000 | 0,0108 | 1,61 | 0,0000 | 0,0087 | 1,61 | 0,0000 | 0,0137 |
| A04- | KN Bruckneudorf | Bruck/Leitha Ost | 0,48 | 0,0000 | 0,0019 | 0,48 | 0,0000 | 0,0029 | 0,67 | 0,0000 | 0,0043 | 0,67 | 0,0000 | 0,0068 | 1,00 | 0,0000 | 0,0054 | 1,00 | 0,0000 | 0,0085 |
| A04- | Parndorf | KN Bruckneudorf | 0,31 | 0,0000 | 0,0012 | 0,31 | 0,0000 | 0,0019 | 0,43 | 0,0000 | 0,0028 | 0,43 | 0,0000 | 0,0044 | 0,64 | 0,0000 | 0,0035 | 0,65 | 0,0000 | 0,0055 |
| A04- | Neusiedl | Parndorf | 0,59 | 0,0000 | 0,0023 | 0,59 | 0,0000 | 0,0037 | 0,83 | 0,0000 | 0,0054 | 0,84 | 0,0000 | 0,0084 | 1,25 | 0,0000 | 0,0068 | 1,25 | 0,0000 | 0,0106 |
| A04- | Neusiedl/Gewerbepark | Neusiedl | 0,14 | 0,0000 | 0,0005 | 0,14 | 0,0000 | 0,0008 | 0,19 | 0,0000 | 0,0012 | 0,19 | 0,0000 | 0,0020 | 0,29 | 0,0000 | 0,0016 | 0,29 | 0,0000 | 0,0025 |
| A04- | Weiden/Gols | Neusiedl/Gewerbepark | 1,23 | 0,0000 | 0,0048 | 1,23 | 0,0000 | 0,0076 | 1,73 | 0,0000 | 0,0111 | 1,73 | 0,0000 | 0,0175 | 2,59 | 0,0000 | 0,0140 | 2,59 | 0,0000 | 0,0220 |
| A04- | Mönchhof | Weiden/Gols | 0,90 | 0,0000 | 0,0035 | 0,90 | 0,0000 | 0,0055 | 1,26 | 0,0000 | 0,0081 | 1,26 | 0,0000 | 0,0127 | 1,89 | 0,0000 | 0,0102 | 1,89 | 0,0000 | 0,0161 |
| A04- | Nickelsdorf | Mönchhof | 1,40 | 0,0000 | 0,0055 | 1,41 | 0,0000 | 0,0087 | 1,97 | 0,0000 | 0,0127 | 1,98 | 0,0000 | 0,0200 | 2,95 | 0,0000 | 0,0160 | 2,96 | 0,0000 | 0,0252 |
| A04- | Staatsgrenze Nickelsdorf | Nickelsdorf | 0,25 | 0,0000 | 0,0010 | 0,25 | 0,0000 | 0,0015 | 0,35 | 0,0000 | 0,0023 | 0,35 | 0,0000 | 0,0035 | 0,52 | 0,0000 | 0,0028 | 0,53 | 0,0000 | 0,0045 |
| A05- | Wolkersdorf Süd | KN Eibesbrunn | 0,48 | 0,0000 | 0,0019 | 0,49 | 0,0000 | 0,0030 | 0,68 | 0,0000 | 0,0044 | 0,68 | 0,0000 | 0,0069 | 1,02 | 0,0000 | 0,0055 | 1,02 | 0,0000 | 0,0087 |
| A05- | Ulrichskirchen | Wolkersdorf Süd | 0,52 | 0,0000 | 0,0021 | 0,53 | 0,0000 | 0,0032 | 0,74 | 0,0000 | 0,0047 | 0,74 | 0,0000 | 0,0074 | 1,10 | 0,0000 | 0,0060 | 1,11 | 0,0000 | 0,0094 |
| A05- | Wolkersdorf Nord | Ulrichskirchen | 0,34 | 0,0000 | 0,0013 | 0,34 | 0,0000 | 0,0021 | 0,48 | 0,0000 | 0,0031 | 0,48 | 0,0000 | 0,0049 | 0,72 | 0,0000 | 0,0039 | 0,72 | 0,0000 | 0,0061 |
| A05- | Hochleithen | Wolkersdorf Nord | 0,61 | 0,0000 | 0,0024 | 0,62 | 0,0000 | 0,0038 | 0,86 | 0,0000 | 0,0056 | 0,87 | 0,0000 | 0,0087 | 1,29 | 0,0000 | 0,0070 | 1,30 | 0,0000 | 0,0110 |
| A05- | Gaweinstal Mitte | Hochleithen | 1,23 | 0,0000 | 0,0048 | 1,23 | 0,0000 | 0,0076 | 1,72 | 0,0000 | 0,0111 | 1,73 | 0,0000 | 0,0175 | 2,58 | 0,0000 | 0,0140 | 2,59 | 0,0000 | 0,0220 |
| A05- | Gaweinstal Nord | Gaweinstal Mitte | 0,33 | 0,0000 | 0,0013 | 0,33 | 0,0000 | 0,0020 | 0,46 | 0,0000 | 0,0029 | 0,46 | 0,0000 | 0,0046 | 0,68 | 0,0000 | 0,0037 | 0,69 | 0,0000 | 0,0058 |
| A05- | Mistelbach Süd | Gaweinstal Nord | 0,56 | 0,0000 | 0,0022 | 0,56 | 0,0000 | 0,0035 | 0,79 | 0,0000 | 0,0051 | 0,79 | 0,0000 | 0,0080 | 1,18 | 0,0000 | 0,0064 | 1,18 | 0,0000 | 0,0101 |
| A05- | Mistelbach Ost / Wilfersdorf | Mistelbach Süd | 0,94 | 0,0000 | 0,0037 | 0,94 | 0,0000 | 0,0058 | 1,32 | 0,0000 | 0,0085 | 1,33 | 0,0000 | 0,0134 | 1,98 | 0,0000 | 0,0107 | 1,99 | 0,0000 | 0,0169 |
| A05- | Poysdorf Süd | Mistelbach Ost / Wilfersdorf | 0,95 | 0,0000 | 0,0037 | 0,95 | 0,0000 | 0,0059 | 1,33 | 0,0000 | 0,0086 | 1,34 | 0,0000 | 0,0135 | 2,00 | 0,0000 | 0,0108 | 2,01 | 0,0000 | 0,0170 |
| A05- | Großkrut | Poysdorf Süd | 1,25 | 0,0000 | 0,0049 | 1,26 | 0,0000 | 0,0077 | 1,76 | 0,0000 | 0,0113 | 1,77 | 0,0000 | 0,0178 | 2,64 | 0,0000 | 0,0143 | 2,65 | 0,0000 | 0,0225 |
| A05- | Poysdorf Nord | Großkrut | 1,22 | 0,0000 | 0,0048 | 1,22 | 0,0000 | 0,0075 | 1,71 | 0,0000 | 0,0110 | 1,72 | 0,0000 | 0,0173 | 2,57 | 0,0000 | 0,0139 | 2,57 | 0,0000 | 0,0219 |
| A06- | Potzneusiedl | KN Bruckneudorf | 1,55 | 0,0000 | 0,0061 | 1,55 | 0,0000 | 0,0095 | 2,17 | 0,0000 | 0,0140 | 2,18 | 0,0000 | 0,0220 | 3,25 | 0,0000 | 0,0176 | 3,26 | 0,0000 | 0,0277 |
| A06- | Gattendorf | Potzneusiedl | 0,67 | 0,0000 | 0,0026 | 0,67 | 0,0000 | 0,0041 | 0,94 | 0,0000 | 0,0061 | 0,94 | 0,0000 | 0,0095 | 1,41 | 0,0000 | 0,0076 | 1,41 | 0,0000 | 0,0120 |
| A06- | Kittsee | Gattendorf | 1,12 | 0,0000 | 0,0044 | 1,12 | 0,0000 | 0,0069 | 1,57 | 0,0000 | 0,0101 | 1,58 | 0,0000 | 0,0159 | 2,36 | 0,0000 | 0,0128 | 2,37 | 0,0000 | 0,0201 |
| A06- | Staatsgrenze Kittsee | Kittsee | 0,57 | 0,0000 | 0,0022 | 0,57 | 0,0000 | 0,0035 | 0,80 | 0,0000 | 0,0052 | 0,80 | 0,0000 | 0,0081 | 1,20 | 0,0000 | 0,0065 | 1,20 | 0,0000 | 0,0102 |
| A07- | Linz Franzosenhausweg | KN Linz | 0,40 | 0,0000 | 0,0016 | 0,40 | 0,0000 | 0,0025 | 0,56 | 0,0000 | 0,0036 | 0,57 | 0,0000 | 0,0057 | 0,85 | 0,0000 | 0,0046 | 0,85 | 0,0000 | 0,0072 |
| A07- | Linz Salzburger Straße Neue Welt | Linz Franzosenhausweg | 0,35 | 0,0000 | 0,0014 | 0,35 | 0,0000 | 0,0022 | 0,49 | 0,0000 | 0,0032 | 0,49 | 0,0000 | 0,0050 | 0,74 | 0,0000 | 0,0040 | 0,74 | 0,0000 | 0,0063 |
| A07- | Muldenstraße Bindermichl | Linz Salzburger Straße Neue Welt | 0,24 | 0,0000 | 0,0010 | 0,24 | 0,0000 | 0,0015 | 0,34 | 0,0000 | 0,0022 | 0,34 | 0,0000 | 0,0035 | 0,51 | 0,0000 | 0,0028 | 0,51 | 0,0000 | 0,0044 |
| A07- | Leonding Linz Zentrum | Muldenstraße Bindermichl | 0,12 | 0,0000 | 0,0005 | 0,12 | 0,0000 | 0,0007 | 0,17 | 0,0000 | 0,0011 | 0,17 | 0,0000 | 0,0017 | 0,25 | 0,0000 | 0,0013 | 0,25 | 0,0000 | 0,0021 |
| A07- | Linzi Wiener Straße | Leonding Linz Zentrum | 0,17 | 0,0000 | 0,0007 | 0,17 | 0,0000 | 0,0010 | 0,23 | 0,0000 | 0,0015 | 0,23 | 0,0000 | 0,0024 | 0,35 | 0,0000 | 0,0019 | 0,35 | 0,0000 | 0,0030 |
| A07- | Linzi VOEST | Linzi Wiener Straße | 0,15 | 0,0000 | 0,0006 | 0,15 | 0,0000 | 0,0010 | 0,22 | 0,0000 | 0,0014 | 0,22 | 0,0000 | 0,0022 | 0,33 | 0,0000 | 0,0018 | 0,33 | 0,0000 | 0,0028 |
| A07- | Linzi Industriezeile | Linzi VOEST | 0,12 | 0,0000 | 0,0005 | 0,12 | 0,0000 | 0,0007 | 0,17 | 0,0000 | 0,0011 | 0,17 | 0,0000 | 0,0017 | 0,26 | 0,0000 | 0,0014 | 0,26 | 0,0000 | 0,0022 |
| A07- | Linzi Prinz Eugenstraße | Linzi Industriezeile | 0,19 | 0,0000 | 0,0008 | 0,19 | 0,0000 | 0,0012 | 0,27 | 0,0000 | 0,0017 | 0,27 | 0,0000 | 0,0027 | 0,40 | 0,0000 | 0,0022 | 0,41 | 0,0000 | 0,0034 |
| A07- | Linzi Hafenstraße | Linzi Prinz Eugenstraße | 0,36 | 0,0000 | 0,0014 | 0,36 | 0,0000 | 0,0022 | 0,51 | 0,0000 | 0,0033 | 0,51 | 0,0000 | 0,0051 | 0,76 | 0,0000 | 0,0041 | 0,76 | 0,0000 | 0,0065 |
| A07- | Linzi Urfahr | Linzi Hafenstraße | 0,14 | 0,0000 | 0,0006 | 0,14 | 0,0000 | 0,0009 | 0,20 | 0,0000 | 0,0013 | 0,20 | 0,0000 | 0,0020 | 0,30 | 0,0000 | 0,0016 | 0,30 | 0,0000 | 0,0025 |
| A07- | Linzi Dornach | Linzi Urfahr | 0,34 | 0,0000 | 0,0013 | 0 | | | | | | | | | | | | | | |

| | | | | | | | | | | | | | | | | | | | | |
|------|---|--------------------------------------|------|--------|--------|------|--------|--------|-------|--------|--------|-------|--------|--------|-------|--------|--------|-------|--------|----------|
| A08- | Staatsgrenze Suben | Schärding Suben | 0,40 | 0,0000 | 0,0016 | 0,40 | 0,0000 | 0,0025 | 0,56 | 0,0000 | 0,0036 | 0,56 | 0,0000 | 0,0056 | 0,84 | 0,0000 | 0,0045 | 0,84 | 0,0000 | 0,0071 |
| A09- | Ried im Traunkreis | KN Voralpenkreuz | 0,98 | 0,0000 | 0,0039 | 0,98 | 0,0000 | 0,0061 | 1,37 | 0,0000 | 0,0089 | 1,38 | 0,0000 | 0,0139 | 2,06 | 0,0000 | 0,0112 | 2,07 | 0,0000 | 0,0175 |
| A09- | Inzersdorf Kirchdorf | Ried im Traunkreis | 1,84 | 0,0000 | 0,0072 | 1,84 | 0,0000 | 0,0114 | 2,58 | 0,0000 | 0,0166 | 2,59 | 0,0000 | 0,0261 | 3,86 | 0,0000 | 0,0209 | 3,88 | 0,0000 | 0,0329 |
| A09- | Klaus | Inzersdorf Kirchdorf | 2,24 | 0,0000 | 0,0088 | 2,24 | 0,0000 | 0,0138 | 3,14 | 0,0000 | 0,0202 | 3,15 | 0,0000 | 0,0318 | 4,71 | 0,0000 | 0,0255 | 4,72 | 0,0000 | 0,0401 |
| A09- | St. Pankratz | Klaus | 1,42 | 0,0000 | 0,0056 | 1,43 | 0,0000 | 0,0088 | 2,00 | 0,0000 | 0,0129 | 2,00 | 0,0000 | 0,0202 | 2,99 | 0,0000 | 0,0162 | 3,00 | 0,0000 | 0,0255 |
| A09- | Roßleiten Windischgarsten | St. Pankratz | 1,98 | 0,0000 | 0,0078 | 1,99 | 0,0000 | 0,0123 | 2,79 | 0,0000 | 0,0179 | 2,80 | 0,0000 | 0,0282 | 4,17 | 0,0000 | 0,0226 | 4,19 | 0,0000 | 0,0356 |
| A09- | Gleinkerau | Roßleiten Windischgarsten | 0,93 | 0,0000 | 0,0037 | 0,93 | 0,0000 | 0,0058 | 1,31 | 0,0000 | 0,0084 | 1,31 | 0,0000 | 0,0133 | 1,96 | 0,0000 | 0,0106 | 1,97 | 0,0000 | 0,0167 |
| A09- | Spital am Pyhrn | Gleinkerau | 0,70 | 0,0000 | 0,0028 | 0,70 | 0,0000 | 0,0043 | 0,99 | 0,0000 | 0,0064 | 0,99 | 0,0000 | 0,0100 | 1,48 | 0,0000 | 0,0080 | 1,48 | 0,0000 | 0,0126 |
| A09- | Ardning / Admont | Spital am Pyhrn | 4,02 | 0,0000 | 0,0070 | 4,02 | 0,0000 | 0,0111 | 5,63 | 0,0000 | 0,0162 | 5,64 | 0,0000 | 0,0254 | 8,45 | 0,0000 | 0,0204 | 8,46 | 0,0000 | 0,0321 |
| A09- | Liezen | Ardning / Admont | 0,41 | 0,0000 | 0,0016 | 0,41 | 0,0000 | 0,0025 | 0,57 | 0,0000 | 0,0037 | 0,57 | 0,0000 | 0,0058 | 0,86 | 0,0000 | 0,0047 | 0,86 | 0,0000 | 0,0073 |
| A09- | Rottenmann | Liezen | 0,85 | 0,0000 | 0,0034 | 0,85 | 0,0000 | 0,0053 | 1,20 | 0,0000 | 0,0077 | 1,20 | 0,0000 | 0,0121 | 1,79 | 0,0000 | 0,0097 | 1,80 | 0,0000 | 0,0153 |
| A09- | Trieben | Rottenmann | 2,13 | 0,0000 | 0,0084 | 2,13 | 0,0000 | 0,0131 | 2,98 | 0,0000 | 0,0192 | 2,99 | 0,0000 | 0,0302 | 4,47 | 0,0000 | 0,0242 | 4,48 | 0,0000 | 0,0381 |
| A09- | Treglwang | Trieben | 1,73 | 0,0000 | 0,0068 | 1,73 | 0,0000 | 0,0107 | 2,43 | 0,0000 | 0,0156 | 2,43 | 0,0000 | 0,0246 | 3,63 | 0,0000 | 0,0197 | 3,65 | 0,0000 | 0,0310 |
| A09- | Kalwang | Treglwang | 2,32 | 0,0000 | 0,0091 | 2,33 | 0,0000 | 0,0143 | 3,26 | 0,0000 | 0,0210 | 3,27 | 0,0000 | 0,0330 | 4,88 | 0,0000 | 0,0265 | 4,90 | 0,0000 | 0,0416 |
| A09- | Mautern | Kalwang | 1,08 | 0,0000 | 0,0043 | 1,08 | 0,0000 | 0,0067 | 1,52 | 0,0000 | 0,0098 | 1,52 | 0,0000 | 0,0154 | 2,27 | 0,0000 | 0,0123 | 2,28 | 0,0000 | 0,0194 |
| A09- | Kammern | Mautern | 1,22 | 0,0000 | 0,0048 | 1,22 | 0,0000 | 0,0075 | 1,71 | 0,0000 | 0,0110 | 1,71 | 0,0000 | 0,0173 | 2,56 | 0,0000 | 0,0139 | 2,57 | 0,0000 | 0,0218 |
| A09- | Traboch | Kammern | 1,27 | 0,0000 | 0,0050 | 1,27 | 0,0000 | 0,0079 | 1,78 | 0,0000 | 0,0115 | 1,79 | 0,0000 | 0,0181 | 2,67 | 0,0000 | 0,0145 | 2,68 | 0,0000 | 0,0228 |
| A09- | Terminal St. Michael | Traboch | 0,25 | 0,0000 | 0,0010 | 0,25 | 0,0000 | 0,0015 | 0,35 | 0,0000 | 0,0023 | 0,35 | 0,0000 | 0,0035 | 0,53 | 0,0000 | 0,0028 | 0,53 | 0,0000 | 0,0045 |
| A09- | KN St. Michael | Terminal St. Michael | 0,47 | 0,0000 | 0,0018 | 0,47 | 0,0000 | 0,0029 | 0,66 | 0,0000 | 0,0042 | 0,66 | 0,0000 | 0,0067 | 0,98 | 0,0000 | 0,0053 | 0,99 | 0,0000 | 0,0084 |
| A09- | Übelbach | KN St. Michael | 9,79 | 0,0000 | 0,0171 | 9,80 | 0,0000 | 0,0269 | 13,72 | 0,0000 | 0,0394 | 13,75 | 0,0000 | 0,0620 | 20,58 | 0,0000 | 0,0497 | 20,61 | 0,0000 | 0,0781 |
| A09- | KN Peggau Deutschefstritz | Übelbach | 1,44 | 0,0000 | 0,0057 | 1,45 | 0,0000 | 0,0089 | 2,02 | 0,0000 | 0,0130 | 2,03 | 0,0000 | 0,0205 | 3,03 | 0,0000 | 0,0164 | 3,04 | 0,0000 | 0,0258 |
| A09- | Gratkorn Nord | KN Peggau Deutschefstritz | 0,68 | 0,0000 | 0,0027 | 0,68 | 0,0000 | 0,0042 | 0,96 | 0,0000 | 0,0062 | 0,96 | 0,0000 | 0,0097 | 1,44 | 0,0000 | 0,0078 | 1,44 | 0,0000 | 0,0122 |
| A09- | Gratkorn Süd | Gratkorn Nord | 0,75 | 0,0000 | 0,0030 | 0,75 | 0,0000 | 0,0046 | 1,05 | 0,0000 | 0,0068 | 1,06 | 0,0000 | 0,0107 | 1,58 | 0,0000 | 0,0086 | 1,58 | 0,0000 | 0,0134 |
| A09- | Graz Nord | Gratkorn Süd | 0,17 | 0,0000 | 0,0007 | 0,17 | 0,0000 | 0,0010 | 0,23 | 0,0000 | 0,0015 | 0,23 | 0,0000 | 0,0024 | 0,35 | 0,0000 | 0,0019 | 0,35 | 0,0000 | 0,0030 |
| A09- | Graz Webling | Graz Nord | 1,90 | 0,0000 | 0,0075 | 1,91 | 0,0000 | 0,0118 | 2,67 | 0,0000 | 0,0172 | 2,68 | 0,0000 | 0,0270 | 4,00 | 0,0000 | 0,0217 | 4,01 | 0,0000 | 0,0341 |
| A09- | Seiersberg | Graz Webling | 0,51 | 0,0000 | 0,0020 | 0,51 | 0,0000 | 0,0031 | 0,71 | 0,0000 | 0,0046 | 0,71 | 0,0000 | 0,0072 | 1,06 | 0,0000 | 0,0058 | 1,07 | 0,0000 | 0,0091 |
| A09- | KN Graz West | Seiersberg | 0,25 | 0,0000 | 0,0010 | 0,25 | 0,0000 | 0,0015 | 0,35 | 0,0000 | 0,0022 | 0,35 | 0,0000 | 0,0035 | 0,52 | 0,0000 | 0,0028 | 0,52 | 0,0000 | 0,0044 |
| A09- | Schwarzlsee | KN Graz West | 0,24 | 0,0000 | 0,0010 | 0,24 | 0,0000 | 0,0015 | 0,34 | 0,0000 | 0,0022 | 0,34 | 0,0000 | 0,0035 | 0,51 | 0,0000 | 0,0028 | 0,51 | 0,0000 | 0,0044 |
| A09- | Schachenwald / IBC Businesscenter | Schwarzlsee | 0,27 | 0,0000 | 0,0011 | 0,27 | 0,0000 | 0,0017 | 0,38 | 0,0000 | 0,0025 | 0,38 | 0,0000 | 0,0039 | 0,57 | 0,0000 | 0,0031 | 0,58 | 0,0000 | 0,0049 |
| A09- | Kalsdorf | Schachenwald / IBC Businesscenter | 0,28 | 0,0000 | 0,0011 | 0,28 | 0,0000 | 0,0017 | 0,39 | 0,0000 | 0,0025 | 0,39 | 0,0000 | 0,0039 | 0,58 | 0,0000 | 0,0032 | 0,59 | 0,0000 | 0,0050 |
| A09- | Werndorf Terminal | Kalsdorf | 0,69 | 0,0000 | 0,0027 | 0,70 | 0,0000 | 0,0043 | 0,97 | 0,0000 | 0,0063 | 0,98 | 0,0000 | 0,0099 | 1,46 | 0,0000 | 0,0079 | 1,46 | 0,0000 | 0,0124 |
| A09- | Wildon | Werndorf Terminal | 0,78 | 0,0000 | 0,0031 | 0,78 | 0,0000 | 0,0048 | 1,09 | 0,0000 | 0,0070 | 1,09 | 0,0000 | 0,0110 | 1,63 | 0,0000 | 0,0088 | 1,64 | 0,0000 | 0,0139 |
| A09- | Hengsberg | Wildon | 0,38 | 0,0000 | 0,0015 | 0,38 | 0,0000 | 0,0023 | 0,53 | 0,0000 | 0,0034 | 0,53 | 0,0000 | 0,0054 | 0,80 | 0,0000 | 0,0043 | 0,80 | 0,0000 | 0,0068 |
| A09- | Lebring | Hengsberg | 0,67 | 0,0000 | 0,0026 | 0,67 | 0,0000 | 0,0041 | 0,94 | 0,0000 | 0,0061 | 0,95 | 0,0000 | 0,0095 | 1,41 | 0,0000 | 0,0077 | 1,42 | 0,0000 | 0,0120 |
| A09- | Leibnitz | Lebring | 1,16 | 0,0000 | 0,0046 | 1,16 | 0,0000 | 0,0072 | 1,63 | 0,0000 | 0,0105 | 1,64 | 0,0000 | 0,0165 | 2,44 | 0,0000 | 0,0132 | 2,45 | 0,0000 | 0,0208 |
| A09- | Vogau Straß | Leibnitz | 1,42 | 0,0000 | 0,0056 | 1,42 | 0,0000 | 0,0088 | 1,99 | 0,0000 | 0,0128 | 2,00 | 0,0000 | 0,0202 | 2,99 | 0,0000 | 0,0162 | 3,00 | 0,0000 | 0,0255 |
| A09- | Gersdorf | Vogau Straß | 0,69 | 0,0000 | 0,0027 | 0,69 | 0,0000 | 0,0043 | 0,97 | 0,0000 | 0,0062 | 0,97 | 0,0000 | 0,0098 | 1,45 | 0,0000 | 0,0079 | 1,45 | 0,0000 | 0,0123 |
| A09- | Spielfeld | Gersdorf | 0,36 | 0,0000 | 0,0014 | 0,36 | 0,0000 | 0,0022 | 0,51 | 0,0000 | 0,0033 | 0,51 | 0,0000 | 0,0052 | 0,76 | 0,0000 | 0,0041 | 0,77 | 0,0000 | 0,0065 |
| A09- | Staatsgrenze Spielfeld | Spielfeld | 0,33 | 0,0000 | 0,0013 | 0,33 | 0,0000 | 0,0020 | 0,46 | 0,0000 | 0,0030 | 0,47 | 0,0000 | 0,0047 | 0,70 | 0,0000 | 0,0038 | 0,70 | 0,0000 | 0,0059 |
| A10- | Salzburg Süd / Anif | KN Salzburg | 1,34 | 0,0000 | 0,0053 | 1,34 | 0,0000 | 0,0083 | 1,88 | 0,0000 | 0,0121 | 1,89 | 0,0000 | 0,0190 | 2,82 | 0,0000 | 0,0153 | 2,83 | 0,0000 | 0,0240 |
| A10- | Puch Urstein | Salzburg Süd / Anif | 0,45 | 0,0000 | 0,0018 | 0,46 | 0,0000 | 0,0028 | 0,64 | 0,0000 | 0,0041 | 0,64 | 0,0000 | 0,0065 | 0,96 | 0,0000 | 0,0052 | 0,96 | 0,0000 | 0,0081 |
| A10- | Hallein | Puch Urstein | 0,94 | 0,0000 | 0,0037 | 0,94 | 0,0000 | 0,0058 | 1,32 | 0,0000 | 0,0085 | 1,32 | 0,0000 | 0,0133 | 1,97 | 0,0000 | 0,0107 | 1,98 | 0,0000 | 0,0168 |
| A10- | Kuchl | Hallein | 1,04 | 0,0000 | 0,0041 | 1,04 | 0,0000 | 0,0064 | 1,46 | 0,0000 | 0,0094 | 1,47 | 0,0000 | 0,0148 | 2,19 | 0,0000 | 0,0119 | 2,20 | 0,0000 | 0,0187 |
| A10- | Golling / Abtenau | Kuchl | 1,05 | 0,0000 | 0,0041 | 1,05 | 0,0000 | 0,0065 | 1,47 | 0,0000 | 0,0095 | 1,48 | 0,0000 | 0,0149 | 2,20 | 0,0000 | 0,0119 | 2,21 | 0,0000 | 0,0188 |
| A10- | Paß Lueg | Golling / Abtenau | 1,09 | 0,0000 | 0,0043 | 1,10 | 0,0000 | 0,0068 | 1,53 | 0,0000 | 0,0099 | 1,54 | 0,0000 | 0,0155 | 2,30 | 0,0000 | 0,0125 | 2,31 | 0,0000 | 0,0196 |
| A10- | Werfen | Paß Lueg | 1,56 | 0,0000 | 0,0061 | 1,56 | 0,0000 | 0,0096 | 2,19 | 0,0000 | 0,0141 | 2,19 | 0,0000 | 0,0221 | 3,27 | 0,0000 | 0,0178 | 3,28 | 0,0000 | 0,0279 |
| A10- | Pfarrwerfen / Werfen | Werfen | 0,20 | 0,0000 | 0,0008 | 0,20 | 0,0000 | 0,0013 | 0,28 | 0,0000 | 0,0018 | 0,29 | 0,0000 | 0,0029 | 0,43 | 0,0000 | 0,0023 | 0,43 | 0,0000 | 0,0036 |
| A10- | KN Pongau | Pfarrwerfen / Werfen | 0,44 | 0,0000 | 0,0017 | 0,44 | 0,0000 | 0,0027 | 0,62 | 0,0000 | 0,0040 | 0,62 | 0,0000 | 0,0063 | 0,93 | 0,0000 | 0,0050 | 0,93 | 0,0000 | 0,0079 |
| A101 | Bischofshofen Mühlbach a. Hochkönig | KN Pongau | 0,66 | 0,0000 | 0,0026 | 0,66 | 0,0000 | 0,0040 | 0,92 | 0,0000 | 0,0059 | 0,92 | 0,0000 | 0,0093 | 1,38 | 0,0000 | 0,0075 | 1,38 | 0,0000 | 0,0117 |
| A10- | Lammertal Hüttai | KN Pongau | 1,79 | 0,0000 | 0,0070 | 1,80 | 0,0000 | 0,0111 | 2,51 | 0,0000 | 0,0162 | 2,52 | 0,0000 | 0,0255 | 3,77 | 0,0000 | 0,0204 | 3,78 | 0,0000 | 0,0321 |
| A10- | F. Verbindung GH Eben | Lammertal Hüttai | 0,46 | 0,0000 | 0,0018 | 0,46 | 0,0000 | 0,0028 | 0,65 | 0,0000 | 0,0042 | 0,65 | 0,0000 | 0,0066 | 0,97 | 0,0000 | 0,0053 | 0,97 | 0,0000 | 0,0083</ |

| | | | | | | | | | | | | | | | | | | | | |
|------|-------------------------------------|-------------------------------------|------|--------|--------|------|--------|--------|------|--------|--------|------|--------|--------|-------|--------|--------|-------|--------|--------|
| A12- | Kufstein Nord | Staatsgrenze Kufstein | 0,35 | 0,0000 | 0,0000 | 0,35 | 0,0000 | 0,0000 | 0,50 | 0,0000 | 0,0000 | 0,50 | 0,0000 | 0,0000 | 0,74 | 0,0000 | 0,0000 | 0,74 | 0,0000 | 0,0000 |
| A12- | Kufstein Süd | Kufstein Nord | 0,91 | 0,0000 | 0,0000 | 0,91 | 0,0000 | 0,0000 | 1,27 | 0,0000 | 0,0000 | 1,27 | 0,0000 | 0,0000 | 1,91 | 0,0000 | 0,0000 | 1,91 | 0,0000 | 0,0000 |
| A12- | Kirchbichl Langkampfen | Kufstein Süd | 1,24 | 0,0000 | 0,0000 | 1,24 | 0,0000 | 0,0000 | 1,74 | 0,0000 | 0,0000 | 1,74 | 0,0000 | 0,0000 | 2,60 | 0,0000 | 0,0000 | 2,60 | 0,0000 | 0,0000 |
| A12- | Wörgl Ost St.Johann i. T. Brixental | Kirchbichl Langkampfen | 1,21 | 0,0000 | 0,0000 | 1,21 | 0,0000 | 0,0000 | 1,70 | 0,0000 | 0,0000 | 1,70 | 0,0000 | 0,0000 | 2,55 | 0,0000 | 0,0000 | 2,55 | 0,0000 | 0,0000 |
| A12- | Wörgl West | Wörgl Ost St.Johann i. T. Brixental | 0,64 | 0,0000 | 0,0000 | 0,64 | 0,0000 | 0,0000 | 0,89 | 0,0000 | 0,0000 | 0,89 | 0,0000 | 0,0000 | 1,34 | 0,0000 | 0,0000 | 1,34 | 0,0000 | 0,0000 |
| A12- | Kramsach Rattenberg Brixlegg | Wörgl West | 2,72 | 0,0000 | 0,0000 | 2,72 | 0,0000 | 0,0000 | 3,81 | 0,0000 | 0,0000 | 3,81 | 0,0000 | 0,0000 | 5,72 | 0,0000 | 0,0000 | 5,72 | 0,0000 | 0,0000 |
| A12- | Wiesing Achensee Zillertal | Kramsach Rattenberg Brixlegg | 1,67 | 0,0000 | 0,0000 | 1,67 | 0,0000 | 0,0000 | 2,34 | 0,0000 | 0,0000 | 2,34 | 0,0000 | 0,0000 | 3,51 | 0,0000 | 0,0000 | 3,51 | 0,0000 | 0,0000 |
| A12- | Jenbach | Wiesing Achensee Zillertal | 0,66 | 0,0000 | 0,0000 | 0,66 | 0,0000 | 0,0000 | 0,93 | 0,0000 | 0,0000 | 0,93 | 0,0000 | 0,0000 | 1,39 | 0,0000 | 0,0000 | 1,39 | 0,0000 | 0,0000 |
| A12- | Schwaz | Jenbach | 1,46 | 0,0000 | 0,0000 | 1,46 | 0,0000 | 0,0000 | 2,04 | 0,0000 | 0,0000 | 2,04 | 0,0000 | 0,0000 | 3,06 | 0,0000 | 0,0000 | 3,06 | 0,0000 | 0,0000 |
| A12- | Vomp | Schwaz | 0,83 | 0,0000 | 0,0000 | 0,83 | 0,0000 | 0,0000 | 1,17 | 0,0000 | 0,0000 | 1,17 | 0,0000 | 0,0000 | 1,75 | 0,0000 | 0,0000 | 1,75 | 0,0000 | 0,0000 |
| A12- | Wattens | Vomp | 1,72 | 0,0000 | 0,0000 | 1,72 | 0,0000 | 0,0000 | 2,41 | 0,0000 | 0,0000 | 2,41 | 0,0000 | 0,0000 | 3,61 | 0,0000 | 0,0000 | 3,61 | 0,0000 | 0,0000 |
| A12- | Hall/Tirol Mitte | Wattens | 1,52 | 0,0000 | 0,0000 | 1,52 | 0,0000 | 0,0000 | 2,13 | 0,0000 | 0,0000 | 2,13 | 0,0000 | 0,0000 | 3,20 | 0,0000 | 0,0000 | 3,20 | 0,0000 | 0,0000 |
| A12- | Hall/Tirol West | Hall/Tirol Mitte | 0,61 | 0,0000 | 0,0000 | 0,61 | 0,0000 | 0,0000 | 0,86 | 0,0000 | 0,0000 | 0,86 | 0,0000 | 0,0000 | 1,29 | 0,0000 | 0,0000 | 1,29 | 0,0000 | 0,0000 |
| A12- | A12 Innsbruck Ost | Hall/Tirol West | 0,68 | 0,0000 | 0,0000 | 0,68 | 0,0000 | 0,0000 | 0,95 | 0,0000 | 0,0000 | 0,95 | 0,0000 | 0,0000 | 1,42 | 0,0000 | 0,0000 | 1,42 | 0,0000 | 0,0000 |
| A12- | Innsbruck Mitte | A12 Innsbruck Ost | 0,44 | 0,0000 | 0,0004 | 0,44 | 0,0000 | 0,0006 | 0,62 | 0,0000 | 0,0009 | 0,62 | 0,0000 | 0,0014 | 0,93 | 0,0000 | 0,0011 | 0,93 | 0,0000 | 0,0018 |
| A12- | A12 Innsbruck West | Innsbruck Mitte | 0,57 | 0,0000 | 0,0022 | 0,57 | 0,0000 | 0,0035 | 0,80 | 0,0000 | 0,0052 | 0,80 | 0,0000 | 0,0081 | 1,20 | 0,0000 | 0,0065 | 1,20 | 0,0000 | 0,0102 |
| A12- | Innsbruck Kranebitten | A12 Innsbruck West | 0,75 | 0,0000 | 0,0029 | 0,75 | 0,0000 | 0,0046 | 1,05 | 0,0000 | 0,0068 | 1,05 | 0,0000 | 0,0106 | 1,57 | 0,0000 | 0,0085 | 1,58 | 0,0000 | 0,0134 |
| A12- | Zirl Ost Garmisch Seefeld | Innsbruck Kranebitten | 0,87 | 0,0000 | 0,0034 | 0,87 | 0,0000 | 0,0054 | 1,22 | 0,0000 | 0,0078 | 1,22 | 0,0000 | 0,0123 | 1,82 | 0,0000 | 0,0099 | 1,83 | 0,0000 | 0,0155 |
| A12- | Zirl West | Zirl Ost Garmisch Seefeld | 0,54 | 0,0000 | 0,0021 | 0,54 | 0,0000 | 0,0033 | 0,76 | 0,0000 | 0,0049 | 0,76 | 0,0000 | 0,0077 | 1,14 | 0,0000 | 0,0062 | 1,14 | 0,0000 | 0,0097 |
| A12- | Petttau | Zirl West | 0,97 | 0,0000 | 0,0038 | 0,97 | 0,0000 | 0,0060 | 1,36 | 0,0000 | 0,0088 | 1,37 | 0,0000 | 0,0138 | 2,04 | 0,0000 | 0,0111 | 2,05 | 0,0000 | 0,0174 |
| A12- | Telfs Ost | Petttau | 0,98 | 0,0000 | 0,0039 | 0,98 | 0,0000 | 0,0061 | 1,38 | 0,0000 | 0,0089 | 1,38 | 0,0000 | 0,0139 | 2,06 | 0,0000 | 0,0112 | 2,07 | 0,0000 | 0,0176 |
| A12- | Telfs West | Telfs Ost | 0,48 | 0,0000 | 0,0019 | 0,48 | 0,0000 | 0,0030 | 0,67 | 0,0000 | 0,0043 | 0,68 | 0,0000 | 0,0068 | 1,01 | 0,0000 | 0,0055 | 1,01 | 0,0000 | 0,0086 |
| A12- | Mötz Reutte | Telfs West | 1,55 | 0,0000 | 0,0061 | 1,55 | 0,0000 | 0,0096 | 2,17 | 0,0000 | 0,0140 | 2,18 | 0,0000 | 0,0220 | 3,26 | 0,0000 | 0,0177 | 3,27 | 0,0000 | 0,0278 |
| A12- | Haiming Ötztal | Mötz Reutte | 1,80 | 0,0000 | 0,0071 | 1,81 | 0,0000 | 0,0111 | 2,53 | 0,0000 | 0,0163 | 2,54 | 0,0000 | 0,0256 | 3,79 | 0,0000 | 0,0205 | 3,80 | 0,0000 | 0,0323 |
| A12- | Imst | Haiming Ötztal | 1,43 | 0,0000 | 0,0056 | 1,44 | 0,0000 | 0,0089 | 2,01 | 0,0000 | 0,0130 | 2,02 | 0,0000 | 0,0204 | 3,02 | 0,0000 | 0,0164 | 3,03 | 0,0000 | 0,0257 |
| A12- | Imst Au | Imst | 0,42 | 0,0000 | 0,0017 | 0,42 | 0,0000 | 0,0026 | 0,59 | 0,0000 | 0,0038 | 0,60 | 0,0000 | 0,0060 | 0,89 | 0,0000 | 0,0048 | 0,89 | 0,0000 | 0,0076 |
| A12- | Mils | Imst Au | 0,34 | 0,0000 | 0,0013 | 0,34 | 0,0000 | 0,0021 | 0,48 | 0,0000 | 0,0031 | 0,48 | 0,0000 | 0,0049 | 0,72 | 0,0000 | 0,0039 | 0,72 | 0,0000 | 0,0061 |
| A12- | Mils Schönwies | Mils | 0,84 | 0,0000 | 0,0033 | 0,84 | 0,0000 | 0,0052 | 1,18 | 0,0000 | 0,0076 | 1,18 | 0,0000 | 0,0119 | 1,77 | 0,0000 | 0,0096 | 1,77 | 0,0000 | 0,0151 |
| A12- | KN Oberinntal | Mils Schönwies | 0,74 | 0,0000 | 0,0029 | 0,75 | 0,0000 | 0,0046 | 1,04 | 0,0000 | 0,0067 | 1,05 | 0,0000 | 0,0106 | 1,56 | 0,0000 | 0,0085 | 1,57 | 0,0000 | 0,0133 |
| A12- | Zams | KN Oberinntal | 0,20 | 0,0000 | 0,0008 | 0,20 | 0,0000 | 0,0012 | 0,27 | 0,0000 | 0,0018 | 0,28 | 0,0000 | 0,0028 | 0,41 | 0,0000 | 0,0022 | 0,41 | 0,0000 | 0,0035 |
| A122 | Fließ | KN Oberinntal | 1,39 | 0,0000 | 0,0055 | 1,40 | 0,0000 | 0,0086 | 1,95 | 0,0000 | 0,0126 | 1,96 | 0,0000 | 0,0198 | 2,93 | 0,0000 | 0,0159 | 2,94 | 0,0000 | 0,0249 |
| A13- | A13 Innsbruck Süd | A12 Innsbruck Ost | 2,14 | 0,0000 | 0,0000 | 2,14 | 0,0000 | 0,0000 | 3,00 | 0,0000 | 0,0000 | 3,00 | 0,0000 | 0,0000 | 4,49 | 0,0000 | 0,0000 | 8,26 | 0,0000 | 0,0000 |
| A13- | Zenzenhof | A13 Innsbruck Süd | 0,85 | 0,0000 | 0,0000 | 0,85 | 0,0000 | 0,0000 | 1,20 | 0,0000 | 0,0000 | 1,20 | 0,0000 | 0,0000 | 1,79 | 0,0000 | 0,0000 | 3,58 | 0,0000 | 0,0000 |
| A13- | Igls Patsch | Zenzenhof | 1,58 | 0,0000 | 0,0000 | 1,58 | 0,0000 | 0,0000 | 2,21 | 0,0000 | 0,0000 | 2,21 | 0,0000 | 0,0000 | 3,31 | 0,0000 | 0,0000 | 6,62 | 0,0000 | 0,0000 |
| A13- | Schönberg Stubaital | Igls Patsch | 1,71 | 0,0000 | 0,0000 | 1,71 | 0,0000 | 0,0000 | 2,39 | 0,0000 | 0,0000 | 2,39 | 0,0000 | 0,0000 | 3,59 | 0,0000 | 0,0000 | 7,18 | 0,0000 | 0,0000 |
| A13- | Matrei Steinach | Schönberg Stubaital | 5,39 | 0,0000 | 0,0000 | 5,39 | 0,0000 | 0,0000 | 7,55 | 0,0000 | 0,0000 | 7,55 | 0,0000 | 0,0000 | 11,32 | 0,0000 | 0,0000 | 22,64 | 0,0000 | 0,0000 |
| A13- | Nösslach | Matrei Steinach | 4,34 | 0,0000 | 0,0000 | 4,34 | 0,0000 | 0,0000 | 6,07 | 0,0000 | 0,0000 | 6,07 | 0,0000 | 0,0000 | 9,10 | 0,0000 | 0,0000 | 18,20 | 0,0000 | 0,0000 |
| A13- | Brenner-Nord | Nösslach | 3,89 | 0,0000 | 0,0000 | 3,89 | 0,0000 | 0,0000 | 5,45 | 0,0000 | 0,0000 | 5,45 | 0,0000 | 0,0000 | 8,17 | 0,0000 | 0,0000 | 16,34 | 0,0000 | 0,0000 |
| A13- | Staatsgrenze Brennerpass | Brenner-Nord | 0,77 | 0,0000 | 0,0000 | 0,77 | 0,0000 | 0,0000 | 1,08 | 0,0000 | 0,0000 | 1,08 | 0,0000 | 0,0000 | 1,62 | 0,0000 | 0,0000 | 3,24 | 0,0000 | 0,0000 |
| A131 | A13 Innsbruck Süd | A12 Innsbruck West | 1,36 | 0,0000 | 0,0007 | 1,36 | 0,0000 | 0,0011 | 1,90 | 0,0000 | 0,0017 | 1,90 | 0,0000 | 0,0026 | 2,85 | 0,0000 | 0,0021 | 5,31 | 0,0000 | 0,0033 |
| A14- | Hörbranz Lochau | Staatsgrenze Hörbranz | 0,22 | 0,0000 | 0,0009 | 0,23 | 0,0000 | 0,0014 | 0,32 | 0,0000 | 0,0020 | 0,32 | 0,0000 | 0,0032 | 0,47 | 0,0000 | 0,0026 | 0,47 | 0,0000 | 0,0040 |
| A14- | KN Bregenz | Hörbranz Lochau | 1,38 | 0,0000 | 0,0054 | 1,38 | 0,0000 | 0,0085 | 1,94 | 0,0000 | 0,0125 | 1,94 | 0,0000 | 0,0196 | 2,90 | 0,0000 | 0,0157 | 2,91 | 0,0000 | 0,0247 |
| A14- | Lauterach Wolfurt | KN Bregenz | 0,07 | 0,0000 | 0,0003 | 0,07 | 0,0000 | 0,0004 | 0,10 | 0,0000 | 0,0006 | 0,10 | 0,0000 | 0,0010 | 0,15 | 0,0000 | 0,0008 | 0,15 | 0,0000 | 0,0012 |
| A14- | Wolfurt Lauterach | Lauterach Wolfurt | 0,61 | 0,0000 | 0,0024 | 0,62 | 0,0000 | 0,0038 | 0,86 | 0,0000 | 0,0056 | 0,86 | 0,0000 | 0,0087 | 1,29 | 0,0000 | 0,0070 | 1,29 | 0,0000 | 0,0110 |
| A14- | Dornbirn Nord Bregenzerwald | Wolfurt Lauterach | 0,24 | 0,0000 | 0,0009 | 0,24 | 0,0000 | 0,0015 | 0,33 | 0,0000 | 0,0021 | 0,33 | 0,0000 | 0,0034 | 0,50 | 0,0000 | 0,0027 | 0,50 | 0,0000 | 0,0043 |
| A14- | Dornbirn Süd Lustenau | Dornbirn Nord Bregenzerwald | 0,66 | 0,0000 | 0,0026 | 0,66 | 0,0000 | 0,0041 | 0,93 | 0,0000 | 0,0060 | 0,93 | 0,0000 | 0,0094 | 1,40 | 0,0000 | 0,0076 | 1,40 | 0,0000 | 0,0119 |
| A14- | Hohenems | Dornbirn Süd Lustenau | 0,93 | 0,0000 | 0,0037 | 0,94 | 0,0000 | 0,0058 | 1,31 | 0,0000 | 0,0084 | 1,32 | 0,0000 | 0,0133 | 1,96 | 0,0000 | 0,0106 | 1,97 | 0,0000 | 0,0167 |
| A14- | Altach Götzis | Hohenems | 0,61 | 0,0000 | 0,0024 | 0,61 | 0,0000 | 0,0038 | 0,85 | 0,0000 | 0,0055 | 0,86 | 0,0000 | 0,0087 | 1,28 | 0,0000 | 0,0069 | 1,28 | 0,0000 | 0,0109 |
| A14- | Götzis | Altach Götzis | 0,46 | 0,0000 | 0,0018 | 0,47 | 0,0000 | 0,0029 | 0,65 | 0,0000 | 0,0042 | 0,65 | 0,0000 | 0,0066 | 0,98 | 0,0000 | 0,0053 | 0,98 | 0,0000 | 0,0083 |
| A14- | Klaus Koblach | Götzis | 0,40 | 0,0000 | 0,0016 | 0,40 | 0,0000 | 0,0025 | 0,57 | 0,0000 | 0,0036 | 0,57 | 0,0000 | 0,0057 | 0,85 | 0,0000 | 0,0046 | 0,85 | 0,0000 | 0,0072 |
| A14- | Rankweil | Klaus Koblach | 0,71 | 0,0000 | 0,0028 | 0,71 | 0,0000 | 0,0044 | 0,99 | 0,0000 | 0,0064 | 1,00 | 0,0000 | 0,0101 | 1,49 | 0,0000 | 0,0081 | 1,49 | 0,0000 | 0,0127 |
| A14- | Feldkirch Frastanz | Rankweil | 1,01 | 0,0000 | 0,0040 | 1,01 | 0,0000 | 0,0062 | 1,42 | 0,0000 | 0,0091 | 1,42 | 0,0000 | 0,0143 | 2,12 | 0,0000 | 0,0115 | 2,13 | 0,0000 | 0,0181 |
| A14- | Nenzing Bludesch | Feldkirch Frastanz | 1,60 | 0,0000 | 0,0063 | 1,60 | 0,0000 | 0,0099 | 2,24 | 0,0000 | 0,0144 | 2,25 | 0,0000 | 0,0227 | 3,36 | 0,0000 | 0,0182 | 3,37 | 0,0000 | 0,0286 |
| A14- | Bludenz Nüziders | Nenzing Bludesch | 1,18 | 0,0000 | 0,0047 | 1,19 | 0,0000 | 0,0073 | 1,66 | 0,0000 | 0,0107 | 1,67 | 0,0000 | 0,0168 | 2,49 | 0,0000 | 0,0135 | 2,50 | 0,0000 | 0,0212 |
| A14- | Brandnertal | Bludenz Nüziders | 0,16 | 0,0000 | 0,0006 | 0,17 | 0,0000 | 0,0010 | 0,23 | 0,0000 | 0,0015 | 0,23 | 0,0000 | 0,0023 | 0,35 | 0,0000 | 0,0019 | 0,35 | 0,0000 | 0,0030 |
| A14- | Bludenz Bürs | Brandnertal | 0,28 | 0,0000 | 0,0011 | 0,28 | 0,0000 | 0,0017 | 0,39 | 0,0000 | 0,0025 | 0,39 | 0,0000 | 0,0039 | 0,58 | 0,0000 | 0,0031 | 0,58 | 0,0000 | 0,0049 |
| A14- | Bludenz Montafon | Bludenz Bürs | 0,39 | 0,000 | | | | | | | | | | | | | | | | |

| | | | | | | | | | | | | | | | | | | | | |
|------|--------------------------------------|--------------------------------------|------|--------|--------|------|--------|--------|------|--------|--------|------|--------|--------|------|--------|--------|------|--------|--------|
| A22- | Strebersdorf | KN Gürtel Nordbrücke | 0,54 | 0,0000 | 0,0021 | 0,54 | 0,0000 | 0,0033 | 0,75 | 0,0000 | 0,0048 | 0,75 | 0,0000 | 0,0076 | 1,13 | 0,0000 | 0,0061 | 1,13 | 0,0000 | 0,0096 |
| A221 | KN Gürtel Nordbrücke | Wien Nordbrücke | 0,16 | 0,0000 | 0,0006 | 0,16 | 0,0000 | 0,0010 | 0,22 | 0,0000 | 0,0014 | 0,22 | 0,0000 | 0,0022 | 0,33 | 0,0000 | 0,0018 | 0,33 | 0,0000 | 0,0028 |
| A221 | Wien Pragerstraße | KN Gürtel Nordbrücke | 0,17 | 0,0000 | 0,0007 | 0,17 | 0,0000 | 0,0011 | 0,24 | 0,0000 | 0,0015 | 0,24 | 0,0000 | 0,0024 | 0,36 | 0,0000 | 0,0019 | 0,36 | 0,0000 | 0,0030 |
| A221 | Wien Neujedlersdorf | Wien Pragerstraße | 0,07 | 0,0000 | 0,0003 | 0,07 | 0,0000 | 0,0005 | 0,10 | 0,0000 | 0,0007 | 0,10 | 0,0000 | 0,0011 | 0,16 | 0,0000 | 0,0008 | 0,16 | 0,0000 | 0,0013 |
| A221 | Brünnerstr/Shuttlewort hstraße | Wien Neujedlersdorf | 0,19 | 0,0000 | 0,0007 | 0,19 | 0,0000 | 0,0012 | 0,26 | 0,0000 | 0,0017 | 0,27 | 0,0000 | 0,0027 | 0,40 | 0,0000 | 0,0022 | 0,40 | 0,0000 | 0,0034 |
| A22- | Korneuburg Ost | Strebersdorf | 1,08 | 0,0000 | 0,0042 | 1,08 | 0,0000 | 0,0067 | 1,51 | 0,0000 | 0,0098 | 1,52 | 0,0000 | 0,0153 | 2,27 | 0,0000 | 0,0123 | 2,28 | 0,0000 | 0,0193 |
| A222 | Wien Vohburggasse | Strebersdorf | 0,13 | 0,0000 | 0,0005 | 0,13 | 0,0000 | 0,0008 | 0,19 | 0,0000 | 0,0012 | 0,19 | 0,0000 | 0,0019 | 0,28 | 0,0000 | 0,0015 | 0,28 | 0,0000 | 0,0024 |
| A22- | KN Korneuburg | Korneuburg Ost | 0,70 | 0,0000 | 0,0027 | 0,70 | 0,0000 | 0,0043 | 0,98 | 0,0000 | 0,0063 | 0,98 | 0,0000 | 0,0099 | 1,46 | 0,0000 | 0,0079 | 1,47 | 0,0000 | 0,0125 |
| A22- | Stockerau Ost | KN Korneuburg | 1,01 | 0,0000 | 0,0040 | 1,02 | 0,0000 | 0,0063 | 1,42 | 0,0000 | 0,0092 | 1,43 | 0,0000 | 0,0144 | 2,13 | 0,0000 | 0,0116 | 2,14 | 0,0000 | 0,0182 |
| A22- | Stockerau Mitte | Stockerau Ost | 0,40 | 0,0000 | 0,0016 | 0,40 | 0,0000 | 0,0025 | 0,57 | 0,0000 | 0,0037 | 0,57 | 0,0000 | 0,0057 | 0,85 | 0,0000 | 0,0046 | 0,85 | 0,0000 | 0,0072 |
| A22- | KN Stockerau/West | Stockerau Mitte | 0,34 | 0,0000 | 0,0013 | 0,34 | 0,0000 | 0,0021 | 0,48 | 0,0000 | 0,0031 | 0,48 | 0,0000 | 0,0049 | 0,72 | 0,0000 | 0,0039 | 0,72 | 0,0000 | 0,0061 |
| A23- | KN Wien Inzersdorf | Altmannsdorferstraße | 0,30 | 0,0000 | 0,0012 | 0,30 | 0,0000 | 0,0019 | 0,42 | 0,0000 | 0,0027 | 0,42 | 0,0000 | 0,0043 | 0,63 | 0,0000 | 0,0034 | 0,63 | 0,0000 | 0,0054 |
| A23- | Favoriten | KN Wien Inzersdorf | 0,76 | 0,0000 | 0,0030 | 0,76 | 0,0000 | 0,0047 | 1,06 | 0,0000 | 0,0068 | 1,07 | 0,0000 | 0,0108 | 1,59 | 0,0000 | 0,0086 | 1,60 | 0,0000 | 0,0136 |
| A23- | KN Gürtel Landstraßer Hauptstraße | Favoriten | 0,47 | 0,0000 | 0,0019 | 0,48 | 0,0000 | 0,0029 | 0,67 | 0,0000 | 0,0043 | 0,67 | 0,0000 | 0,0067 | 1,00 | 0,0000 | 0,0054 | 1,00 | 0,0000 | 0,0085 |
| A23- | St. Marx | KN Gürtel Landstraßer Hauptstraße | 0,18 | 0,0000 | 0,0007 | 0,18 | 0,0000 | 0,0011 | 0,25 | 0,0000 | 0,0016 | 0,25 | 0,0000 | 0,0026 | 0,38 | 0,0000 | 0,0021 | 0,38 | 0,0000 | 0,0032 |
| A23- | KN Wien Prater | St. Marx | 0,15 | 0,0000 | 0,0006 | 0,15 | 0,0000 | 0,0009 | 0,21 | 0,0000 | 0,0014 | 0,22 | 0,0000 | 0,0022 | 0,32 | 0,0000 | 0,0017 | 0,32 | 0,0000 | 0,0027 |
| A23- | Handelskai | KN Wien Prater | 0,34 | 0,0000 | 0,0013 | 0,34 | 0,0000 | 0,0021 | 0,48 | 0,0000 | 0,0031 | 0,48 | 0,0000 | 0,0048 | 0,71 | 0,0000 | 0,0039 | 0,72 | 0,0000 | 0,0061 |
| A23- | KN Wien Kaisermühlen | Handelskai | 0,16 | 0,0000 | 0,0006 | 0,16 | 0,0000 | 0,0010 | 0,22 | 0,0000 | 0,0014 | 0,22 | 0,0000 | 0,0022 | 0,33 | 0,0000 | 0,0018 | 0,33 | 0,0000 | 0,0028 |
| A23- | Groß Enzersdorf Stadlau | KN Wien Kaisermühlen | 0,43 | 0,0000 | 0,0017 | 0,43 | 0,0000 | 0,0026 | 0,60 | 0,0000 | 0,0038 | 0,60 | 0,0000 | 0,0060 | 0,89 | 0,0000 | 0,0049 | 0,90 | 0,0000 | 0,0076 |
| A23- | Hirschstetten | Groß Enzersdorf Stadlau | 0,24 | 0,0000 | 0,0009 | 0,24 | 0,0000 | 0,0015 | 0,33 | 0,0000 | 0,0022 | 0,34 | 0,0000 | 0,0034 | 0,50 | 0,0000 | 0,0027 | 0,50 | 0,0000 | 0,0043 |
| A233 | Wien Gürtel | KN Gürtel Landstraßer Hauptstraße | 0,14 | 0,0000 | 0,0005 | 0,14 | 0,0000 | 0,0009 | 0,20 | 0,0000 | 0,0013 | 0,20 | 0,0000 | 0,0020 | 0,29 | 0,0000 | 0,0016 | 0,29 | 0,0000 | 0,0025 |
| A25- | Weißkirchen | KN A1/A25 Passau Wels | 1,57 | 0,0000 | 0,0062 | 1,57 | 0,0000 | 0,0097 | 2,20 | 0,0000 | 0,0142 | 2,21 | 0,0000 | 0,0223 | 3,30 | 0,0000 | 0,0179 | 3,31 | 0,0000 | 0,0281 |
| A25- | Marchtrenk Wels Ost | Weißkirchen | 0,56 | 0,0000 | 0,0022 | 0,56 | 0,0000 | 0,0035 | 0,78 | 0,0000 | 0,0051 | 0,79 | 0,0000 | 0,0079 | 1,18 | 0,0000 | 0,0064 | 1,18 | 0,0000 | 0,0100 |
| A25- | ÖBB Terminal Wels | Marchtrenk Wels Ost | 0,15 | 0,0000 | 0,0006 | 0,15 | 0,0000 | 0,0009 | 0,21 | 0,0000 | 0,0014 | 0,21 | 0,0000 | 0,0021 | 0,32 | 0,0000 | 0,0017 | 0,32 | 0,0000 | 0,0027 |
| A25- | Wels Nord | ÖBB Terminal Wels | 0,72 | 0,0000 | 0,0028 | 0,72 | 0,0000 | 0,0045 | 1,01 | 0,0000 | 0,0065 | 1,02 | 0,0000 | 0,0102 | 1,52 | 0,0000 | 0,0082 | 1,52 | 0,0000 | 0,0129 |
| A25- | KN Wels | Wels Nord | 0,51 | 0,0000 | 0,0020 | 0,51 | 0,0000 | 0,0032 | 0,72 | 0,0000 | 0,0046 | 0,72 | 0,0000 | 0,0073 | 1,08 | 0,0000 | 0,0059 | 1,08 | 0,0000 | 0,0092 |
| S01- | Vorarlberger Allee | KN Vösendorf | 0,38 | 0,0000 | 0,0015 | 0,38 | 0,0000 | 0,0024 | 0,53 | 0,0000 | 0,0034 | 0,54 | 0,0000 | 0,0054 | 0,80 | 0,0000 | 0,0043 | 0,80 | 0,0000 | 0,0068 |
| S01- | Laxenburger Str. | Vorarlberger Allee | 0,20 | 0,0000 | 0,0008 | 0,20 | 0,0000 | 0,0012 | 0,28 | 0,0000 | 0,0018 | 0,28 | 0,0000 | 0,0028 | 0,42 | 0,0000 | 0,0023 | 0,42 | 0,0000 | 0,0036 |
| S01- | Güterzentrum Wien Süd | Laxenburger Str. | 0,25 | 0,0000 | 0,0010 | 0,25 | 0,0000 | 0,0015 | 0,35 | 0,0000 | 0,0022 | 0,35 | 0,0000 | 0,0035 | 0,52 | 0,0000 | 0,0028 | 0,52 | 0,0000 | 0,0044 |
| S01- | Rothneusiedl | Güterzentrum Wien Süd | 0,16 | 0,0000 | 0,0006 | 0,16 | 0,0000 | 0,0010 | 0,23 | 0,0000 | 0,0015 | 0,23 | 0,0000 | 0,0023 | 0,34 | 0,0000 | 0,0018 | 0,34 | 0,0000 | 0,0029 |
| S01- | KN Rustenfeld | Rothneusiedl | 0,38 | 0,0000 | 0,0015 | 0,38 | 0,0000 | 0,0023 | 0,53 | 0,0000 | 0,0034 | 0,53 | 0,0000 | 0,0054 | 0,79 | 0,0000 | 0,0043 | 0,79 | 0,0000 | 0,0067 |
| S01- | Rannersdorf | KN Rustenfeld | 0,53 | 0,0000 | 0,0021 | 0,53 | 0,0000 | 0,0033 | 0,74 | 0,0000 | 0,0048 | 0,74 | 0,0000 | 0,0075 | 1,11 | 0,0000 | 0,0060 | 1,11 | 0,0000 | 0,0095 |
| S011 | Leopoldsdorf (B16) | KN Rustenfeld | 0,23 | 0,0000 | 0,0009 | 0,23 | 0,0000 | 0,0014 | 0,33 | 0,0000 | 0,0021 | 0,33 | 0,0000 | 0,0033 | 0,49 | 0,0000 | 0,0027 | 0,49 | 0,0000 | 0,0042 |
| S01- | Schwechat Süd | Rannersdorf | 0,41 | 0,0000 | 0,0016 | 0,41 | 0,0000 | 0,0026 | 0,58 | 0,0000 | 0,0037 | 0,58 | 0,0000 | 0,0059 | 0,87 | 0,0000 | 0,0047 | 0,87 | 0,0000 | 0,0074 |
| S01- | Schwechat Ost | Schwechat Süd | 0,24 | 0,0000 | 0,0009 | 0,24 | 0,0000 | 0,0015 | 0,33 | 0,0000 | 0,0021 | 0,33 | 0,0000 | 0,0034 | 0,50 | 0,0000 | 0,0027 | 0,50 | 0,0000 | 0,0042 |
| S01- | Mannswörth | Schwechat Ost | 0,25 | 0,0000 | 0,0010 | 0,25 | 0,0000 | 0,0015 | 0,35 | 0,0000 | 0,0023 | 0,35 | 0,0000 | 0,0036 | 0,53 | 0,0000 | 0,0029 | 0,53 | 0,0000 | 0,0045 |
| S01- | KN Schwechat | Mannswörth | 0,09 | 0,0000 | 0,0004 | 0,09 | 0,0000 | 0,0006 | 0,13 | 0,0000 | 0,0008 | 0,13 | 0,0000 | 0,0013 | 0,20 | 0,0000 | 0,0011 | 0,20 | 0,0000 | 0,0017 |
| S01- | Seyring | Angerner Straße | 0,88 | 0,0000 | 0,0034 | 0,88 | 0,0000 | 0,0054 | 1,23 | 0,0000 | 0,0079 | 1,24 | 0,0000 | 0,0125 | 1,84 | 0,0000 | 0,0100 | 1,85 | 0,0000 | 0,0157 |
| S01- | KN Eibesbrunn | Seyring | 0,73 | 0,0000 | 0,0029 | 0,74 | 0,0000 | 0,0045 | 1,03 | 0,0000 | 0,0066 | 1,03 | 0,0000 | 0,0104 | 1,54 | 0,0000 | 0,0084 | 1,55 | 0,0000 | 0,0131 |
| S01- | Hagenbrunn | KN Eibesbrunn | 0,58 | 0,0000 | 0,0023 | 0,58 | 0,0000 | 0,0036 | 0,81 | 0,0000 | 0,0052 | 0,81 | 0,0000 | 0,0082 | 1,21 | 0,0000 | 0,0066 | 1,22 | 0,0000 | 0,0104 |
| S01- | Korneuburg Nord | Hagenbrunn | 1,24 | 0,0000 | 0,0049 | 1,24 | 0,0000 | 0,0076 | 1,73 | 0,0000 | 0,0112 | 1,74 | 0,0000 | 0,0176 | 2,60 | 0,0000 | 0,0141 | 2,61 | 0,0000 | 0,0221 |
| S01- | Korneuburg West | Korneuburg Nord | 0,50 | 0,0000 | 0,0020 | 0,50 | 0,0000 | 0,0031 | 0,70 | 0,0000 | 0,0045 | 0,71 | 0,0000 | 0,0071 | 1,05 | 0,0000 | 0,0057 | 1,06 | 0,0000 | 0,0090 |
| S01- | KN Korneuburg | Korneuburg West | 0,16 | 0,0000 | 0,0006 | 0,16 | 0,0000 | 0,0010 | 0,22 | 0,0000 | 0,0014 | 0,23 | 0,0000 | 0,0023 | 0,34 | 0,0000 | 0,0018 | 0,34 | 0,0000 | 0,0029 |
| S02- | Gewerbepark Stadlau | Hirschstetten | 0,17 | 0,0000 | 0,0007 | 0,17 | 0,0000 | 0,0011 | 0,24 | 0,0000 | 0,0016 | 0,24 | 0,0000 | 0,0024 | 0,36 | 0,0000 | 0,0020 | 0,36 | 0,0000 | 0,0031 |
| S02- | Breitenleer Straße | Gewerbepark Stadlau | 0,10 | 0,0000 | 0,0004 | 0,10 | 0,0000 | 0,0006 | 0,13 | 0,0000 | 0,0009 | 0,13 | 0,0000 | 0,0014 | 0,20 | 0,0000 | 0,0011 | 0,20 | 0,0000 | 0,0017 |
| S02- | Rautenweg | Breitenleer Straße | 0,16 | 0,0000 | 0,0006 | 0,16 | 0,0000 | 0,0010 | 0,22 | 0,0000 | 0,0014 | 0,22 | 0,0000 | 0,0022 | 0,33 | 0,0000 | 0,0018 | 0,33 | 0,0000 | 0,0028 |
| S02- | Hermann Gebauer Straße | Rautenweg | 0,17 | 0,0000 | 0,0007 | 0,17 | 0,0000 | 0,0011 | 0,24 | 0,0000 | 0,0016 | 0,24 | 0,0000 | 0,0025 | 0,37 | 0,0000 | 0,0020 | 0,37 | 0,0000 | 0,0031 |
| S02- | Angerner Straße | Hermann Gebauer Straße | 0,63 | 0,0000 | 0,0025 | 0,63 | 0,0000 | 0,0039 | 0,88 | 0,0000 | 0,0057 | 0,89 | 0,0000 | 0,0089 | 1,32 | 0,0000 | 0,0072 | 1,33 | 0,0000 | 0,0113 |
| S03- | Stockerau Nord | KN Stockerau/West | 0,18 | 0,0000 | 0,0007 | 0,18 | 0,0000 | 0,0011 | 0,25 | 0,0000 | 0,0016 | 0,25 | 0,0000 | 0,0025 | 0,37 | 0,0000 | 0,0020 | 0,37 | 0,0000 | 0,0032 |
| S03- | Sierndorf | Stockerau Nord | 0,95 | 0,0000 | 0,0038 | 0,96 | 0,0000 | 0,0059 | 1,34 | 0,0000 | 0,0086 | 1,35 | 0,0000 | 0,0136 | 2,01 | 0,0000 | 0,0109 | 2,01 | 0,0000 | 0,0171 |
| S03- | Obermallebarn | Sierndorf | 0,64 | 0,0000 | 0,0025 | 0,64 | 0,0000 | 0,0040 | 0,90 | 0,0000 | 0,0058 | 0,90 | 0,0000 | 0,0091 | 1,35 | 0,0000 | 0,0073 | 1,35 | 0,0000 | 0,0115 |
| S03- | Göllersdorf | Obermallebarn | 0,85 | 0,0000 | 0,0033 | 0,85 | 0,0000 | 0,0052 | 1,19 | 0,0000 | 0,0077 | 1,19 | 0,0000 | 0,0120 | 1,78 | 0,0000 | 0,0097 | 1,79 | 0,0000 | 0,0152 |
| S03- | Großstelzendorf | Göllersdorf | 0,34 | 0,0000 | 0,0013 | 0,34 | 0,0000 | 0,0021 | 0,48 | 0,0000 | 0,0031 | 0,48 | 0,0000 | 0,0048 | 0,71 | 0,0000 | 0,0039 | 0,72 | 0,0000 | 0,0061 |
| S03- | Hollabrunn Süd | Großstelzendorf | 0,82 | 0,0000 | 0,0032 | 0,82 | 0,0000 | 0,0050 | 1,14 | 0,0000 | 0,0074 | 1,15 | 0,0000 | 0,0116 | 1,71 | 0,0000 | 0,0093 | 1,72 | 0,0000 | 0,0146 |
| S04- | Sigleß | KN Mattersburg | 0,42 | 0,0000 | 0,0017 | 0,42 | 0,0000 | 0,0026 | 0,59 | 0,0000 | 0,0038 | 0,59 | 0,0000 | 0,0060 | 0,89 | 0,0000 | 0,0048 | 0,89 | 0,0000 | 0,0076 |
| S04- | Bad Sauerbrunn | Sigleß | 0,98 | 0,0000 | 0,0039 | 0,99 | 0,0000 | 0,0061 | 1,38 | 0,0000 | 0,0089 | 1,39 | 0,0000 | 0,0140 | 2,07 | 0,0000 | 0,0112 | 2,08 | 0,0000 | 0,0177 |
| S04- | | | | | | | | | | | | | | | | | | | | |

| | | | | | | | | | | | | | | | | | | | | |
|------|-----------------------------------|-----------------------------------|------|--------|--------|------|--------|--------|-------|--------|--------|-------|--------|--------|-------|--------|--------|-------|--------|--------|
| S06- | Gloggnitz | Neunkirchen | 2,17 | 0,0000 | 0,0085 | 2,17 | 0,0000 | 0,0134 | 3,04 | 0,0000 | 0,0196 | 3,05 | 0,0000 | 0,0308 | 4,56 | 0,0000 | 0,0247 | 4,57 | 0,0000 | 0,0388 |
| S06- | Maria Schutz | Gloggnitz | 1,38 | 0,0000 | 0,0054 | 1,38 | 0,0000 | 0,0085 | 1,94 | 0,0000 | 0,0125 | 1,95 | 0,0000 | 0,0196 | 2,90 | 0,0000 | 0,0157 | 2,91 | 0,0000 | 0,0247 |
| S06- | Spital / Semmering | Maria Schutz | 1,17 | 0,0000 | 0,0046 | 1,17 | 0,0000 | 0,0072 | 1,64 | 0,0000 | 0,0106 | 1,65 | 0,0000 | 0,0167 | 2,46 | 0,0000 | 0,0134 | 2,47 | 0,0000 | 0,0210 |
| S06- | Mürzzuschlag Ost | Spital / Semmering | 0,98 | 0,0000 | 0,0039 | 0,98 | 0,0000 | 0,0061 | 1,37 | 0,0000 | 0,0089 | 1,38 | 0,0000 | 0,0139 | 2,06 | 0,0000 | 0,0112 | 2,07 | 0,0000 | 0,0175 |
| S06- | Mariazell, Mürzsteg, Mürzzuschlag | Mürzzuschlag Ost | 0,87 | 0,0000 | 0,0034 | 0,87 | 0,0000 | 0,0054 | 1,22 | 0,0000 | 0,0079 | 1,22 | 0,0000 | 0,0123 | 1,83 | 0,0000 | 0,0099 | 1,83 | 0,0000 | 0,0156 |
| S06- | Hönigsberg | Mariazell, Mürzsteg, Mürzzuschlag | 0,62 | 0,0000 | 0,0024 | 0,62 | 0,0000 | 0,0038 | 0,87 | 0,0000 | 0,0056 | 0,87 | 0,0000 | 0,0088 | 1,30 | 0,0000 | 0,0071 | 1,31 | 0,0000 | 0,0111 |
| S06- | Langenwang | Hönigsberg | 0,34 | 0,0000 | 0,0013 | 0,34 | 0,0000 | 0,0021 | 0,48 | 0,0000 | 0,0031 | 0,48 | 0,0000 | 0,0049 | 0,72 | 0,0000 | 0,0039 | 0,72 | 0,0000 | 0,0061 |
| S06- | Krieglach | Langenwang | 0,41 | 0,0000 | 0,0016 | 0,41 | 0,0000 | 0,0025 | 0,57 | 0,0000 | 0,0037 | 0,57 | 0,0000 | 0,0058 | 0,86 | 0,0000 | 0,0046 | 0,86 | 0,0000 | 0,0073 |
| S06- | Mitterdorf | Krieglach | 1,03 | 0,0000 | 0,0040 | 1,03 | 0,0000 | 0,0064 | 1,44 | 0,0000 | 0,0093 | 1,45 | 0,0000 | 0,0146 | 2,16 | 0,0000 | 0,0117 | 2,17 | 0,0000 | 0,0184 |
| S06- | Kindberg Ost | Mitterdorf | 1,04 | 0,0000 | 0,0041 | 1,05 | 0,0000 | 0,0065 | 1,47 | 0,0000 | 0,0095 | 1,47 | 0,0000 | 0,0149 | 2,20 | 0,0000 | 0,0119 | 2,20 | 0,0000 | 0,0187 |
| S06- | Kindberg West | Kindberg Ost | 0,22 | 0,0000 | 0,0009 | 0,22 | 0,0000 | 0,0014 | 0,31 | 0,0000 | 0,0020 | 0,32 | 0,0000 | 0,0032 | 0,47 | 0,0000 | 0,0026 | 0,47 | 0,0000 | 0,0040 |
| S06- | Kindberg Dörfel | Kindberg West | 0,22 | 0,0000 | 0,0009 | 0,22 | 0,0000 | 0,0014 | 0,31 | 0,0000 | 0,0020 | 0,32 | 0,0000 | 0,0032 | 0,47 | 0,0000 | 0,0026 | 0,47 | 0,0000 | 0,0040 |
| S06- | Allerheiligen Mürzhofen | Kindberg Dörfel | 0,50 | 0,0000 | 0,0020 | 0,51 | 0,0000 | 0,0031 | 0,71 | 0,0000 | 0,0046 | 0,71 | 0,0000 | 0,0072 | 1,06 | 0,0000 | 0,0058 | 1,06 | 0,0000 | 0,0090 |
| S06- | St. Marein | Allerheiligen Mürzhofen | 0,76 | 0,0000 | 0,0030 | 0,76 | 0,0000 | 0,0047 | 1,06 | 0,0000 | 0,0069 | 1,07 | 0,0000 | 0,0108 | 1,59 | 0,0000 | 0,0086 | 1,60 | 0,0000 | 0,0136 |
| S06- | Kapfenberg | St. Marein | 0,54 | 0,0000 | 0,0021 | 0,54 | 0,0000 | 0,0033 | 0,75 | 0,0000 | 0,0049 | 0,76 | 0,0000 | 0,0076 | 1,13 | 0,0000 | 0,0061 | 1,13 | 0,0000 | 0,0096 |
| S06- | KN Bruck/Mur | Kapfenberg | 1,00 | 0,0000 | 0,0039 | 1,01 | 0,0000 | 0,0062 | 1,41 | 0,0000 | 0,0091 | 1,41 | 0,0000 | 0,0143 | 2,11 | 0,0000 | 0,0114 | 2,12 | 0,0000 | 0,0180 |
| S06- | ASt Bruck/Mur | KN Bruck/Mur | 0,86 | 0,0000 | 0,0034 | 0,86 | 0,0000 | 0,0053 | 1,21 | 0,0000 | 0,0078 | 1,21 | 0,0000 | 0,0122 | 1,81 | 0,0000 | 0,0098 | 1,82 | 0,0000 | 0,0154 |
| S06- | Niklasdorf | ASt Bruck/Mur | 0,80 | 0,0000 | 0,0031 | 0,80 | 0,0000 | 0,0049 | 1,12 | 0,0000 | 0,0072 | 1,12 | 0,0000 | 0,0113 | 1,67 | 0,0000 | 0,0091 | 1,68 | 0,0000 | 0,0143 |
| S06- | Leoben Ost | Niklasdorf | 0,85 | 0,0000 | 0,0033 | 0,85 | 0,0000 | 0,0052 | 1,19 | 0,0000 | 0,0077 | 1,20 | 0,0000 | 0,0121 | 1,78 | 0,0000 | 0,0097 | 1,79 | 0,0000 | 0,0152 |
| S06- | Leoben West | Leoben Ost | 0,95 | 0,0000 | 0,0037 | 0,95 | 0,0000 | 0,0059 | 1,33 | 0,0000 | 0,0086 | 1,34 | 0,0000 | 0,0135 | 2,00 | 0,0000 | 0,0108 | 2,00 | 0,0000 | 0,0170 |
| S06- | KN St. Michael | Leoben West | 1,18 | 0,0000 | 0,0046 | 1,18 | 0,0000 | 0,0073 | 1,65 | 0,0000 | 0,0106 | 1,66 | 0,0000 | 0,0167 | 2,47 | 0,0000 | 0,0134 | 2,48 | 0,0000 | 0,0211 |
| S10- | Neumarkt | Unterweikersdorf | 1,19 | 0,0000 | 0,0047 | 1,19 | 0,0000 | 0,0074 | 1,67 | 0,0000 | 0,0108 | 1,68 | 0,0000 | 0,0169 | 2,51 | 0,0000 | 0,0136 | 2,51 | 0,0000 | 0,0214 |
| S10- | Kefermarkt | Neumarkt | 0,68 | 0,0000 | 0,0027 | 0,69 | 0,0000 | 0,0042 | 0,96 | 0,0000 | 0,0062 | 0,96 | 0,0000 | 0,0097 | 1,44 | 0,0000 | 0,0078 | 1,44 | 0,0000 | 0,0123 |
| S10- | Freistadt / Süd | Kefermarkt | 0,74 | 0,0000 | 0,0029 | 0,74 | 0,0000 | 0,0046 | 1,03 | 0,0000 | 0,0067 | 1,04 | 0,0000 | 0,0105 | 1,55 | 0,0000 | 0,0084 | 1,55 | 0,0000 | 0,0132 |
| S10- | Grünbach Sandl | Freistadt / Süd | 0,78 | 0,0000 | 0,0031 | 0,78 | 0,0000 | 0,0048 | 1,09 | 0,0000 | 0,0070 | 1,10 | 0,0000 | 0,0111 | 1,64 | 0,0000 | 0,0089 | 1,64 | 0,0000 | 0,0140 |
| S10- | Freistadt / Nord | Grünbach Sandl | 0,21 | 0,0000 | 0,0008 | 0,21 | 0,0000 | 0,0013 | 0,30 | 0,0000 | 0,0019 | 0,30 | 0,0000 | 0,0030 | 0,45 | 0,0000 | 0,0024 | 0,45 | 0,0000 | 0,0038 |
| S16- | Landeck West | Zams | 0,91 | 0,0000 | 0,0036 | 0,91 | 0,0000 | 0,0056 | 1,28 | 0,0000 | 0,0082 | 1,28 | 0,0000 | 0,0129 | 1,91 | 0,0000 | 0,0104 | 1,92 | 0,0000 | 0,0163 |
| S16- | Pians | Landeck West | 0,58 | 0,0000 | 0,0023 | 0,58 | 0,0000 | 0,0036 | 0,82 | 0,0000 | 0,0053 | 0,82 | 0,0000 | 0,0083 | 1,23 | 0,0000 | 0,0067 | 1,23 | 0,0000 | 0,0105 |
| S16- | Flirsch | Pians | 1,16 | 0,0000 | 0,0045 | 1,16 | 0,0000 | 0,0071 | 1,62 | 0,0000 | 0,0105 | 1,63 | 0,0000 | 0,0164 | 2,43 | 0,0000 | 0,0132 | 2,44 | 0,0000 | 0,0207 |
| S16- | Schnann am Arlberg | Flirsch | 0,73 | 0,0000 | 0,0029 | 0,73 | 0,0000 | 0,0045 | 1,02 | 0,0000 | 0,0066 | 1,02 | 0,0000 | 0,0103 | 1,53 | 0,0000 | 0,0083 | 1,53 | 0,0000 | 0,0130 |
| S16- | Pettneu | Schnann am Arlberg | 0,53 | 0,0000 | 0,0021 | 0,53 | 0,0000 | 0,0033 | 0,74 | 0,0000 | 0,0048 | 0,74 | 0,0000 | 0,0075 | 1,11 | 0,0000 | 0,0060 | 1,11 | 0,0000 | 0,0095 |
| S16- | St. Anton/Arlberg | Pettneu | 0,29 | 0,0000 | 0,0012 | 0,29 | 0,0000 | 0,0018 | 0,41 | 0,0000 | 0,0027 | 0,41 | 0,0000 | 0,0042 | 0,62 | 0,0000 | 0,0033 | 0,62 | 0,0000 | 0,0053 |
| S16- | Langen/Arlberg | St. Anton/Arlberg | 7,58 | 0,0000 | 0,0112 | 7,58 | 0,0000 | 0,0177 | 10,62 | 0,0000 | 0,0258 | 10,63 | 0,0000 | 0,0406 | 15,92 | 0,0000 | 0,0326 | 15,94 | 0,0000 | 0,0512 |
| S16- | Wald/Arlberg | Langen/Arlberg | 0,94 | 0,0000 | 0,0037 | 0,94 | 0,0000 | 0,0058 | 1,31 | 0,0000 | 0,0085 | 1,32 | 0,0000 | 0,0133 | 1,97 | 0,0000 | 0,0107 | 1,97 | 0,0000 | 0,0168 |
| S16- | Dalaas | Wald/Arlberg | 1,07 | 0,0000 | 0,0042 | 1,07 | 0,0000 | 0,0066 | 1,50 | 0,0000 | 0,0096 | 1,50 | 0,0000 | 0,0152 | 2,24 | 0,0000 | 0,0122 | 2,25 | 0,0000 | 0,0191 |
| S16- | Braz Ost | Dalaas | 0,60 | 0,0000 | 0,0024 | 0,61 | 0,0000 | 0,0037 | 0,85 | 0,0000 | 0,0055 | 0,85 | 0,0000 | 0,0086 | 1,27 | 0,0000 | 0,0069 | 1,27 | 0,0000 | 0,0108 |
| S16- | Braz West | Braz Ost | 0,47 | 0,0000 | 0,0019 | 0,47 | 0,0000 | 0,0029 | 0,66 | 0,0000 | 0,0043 | 0,66 | 0,0000 | 0,0067 | 0,99 | 0,0000 | 0,0054 | 0,99 | 0,0000 | 0,0085 |
| S16- | Bings | Braz West | 0,64 | 0,0000 | 0,0025 | 0,64 | 0,0000 | 0,0039 | 0,90 | 0,0000 | 0,0058 | 0,90 | 0,0000 | 0,0091 | 1,34 | 0,0000 | 0,0073 | 1,35 | 0,0000 | 0,0114 |
| S16- | Bludenz Montafon | Bings | 0,30 | 0,0000 | 0,0012 | 0,30 | 0,0000 | 0,0019 | 0,42 | 0,0000 | 0,0027 | 0,43 | 0,0000 | 0,0043 | 0,64 | 0,0000 | 0,0034 | 0,64 | 0,0000 | 0,0054 |
| S31- | Eisenstadt Süd | Eisenstadt Ost | 0,55 | 0,0000 | 0,0022 | 0,55 | 0,0000 | 0,0034 | 0,77 | 0,0000 | 0,0050 | 0,77 | 0,0000 | 0,0078 | 1,15 | 0,0000 | 0,0063 | 1,16 | 0,0000 | 0,0098 |
| S31- | Eisenstadt Mitte | Eisenstadt Süd | 0,21 | 0,0000 | 0,0008 | 0,21 | 0,0000 | 0,0013 | 0,29 | 0,0000 | 0,0019 | 0,29 | 0,0000 | 0,0029 | 0,43 | 0,0000 | 0,0023 | 0,43 | 0,0000 | 0,0037 |
| S31- | KN Eisenstadt | Eisenstadt Mitte | 0,34 | 0,0000 | 0,0013 | 0,34 | 0,0000 | 0,0021 | 0,48 | 0,0000 | 0,0031 | 0,48 | 0,0000 | 0,0048 | 0,71 | 0,0000 | 0,0039 | 0,71 | 0,0000 | 0,0061 |
| S31- | Wulkaprodersdorf | KN Eisenstadt | 0,45 | 0,0000 | 0,0018 | 0,45 | 0,0000 | 0,0028 | 0,63 | 0,0000 | 0,0041 | 0,63 | 0,0000 | 0,0064 | 0,95 | 0,0000 | 0,0051 | 0,95 | 0,0000 | 0,0081 |
| S31- | KN Mattersburg | Wulkaprodersdorf | 1,28 | 0,0000 | 0,0050 | 1,28 | 0,0000 | 0,0079 | 1,80 | 0,0000 | 0,0116 | 1,80 | 0,0000 | 0,0182 | 2,69 | 0,0000 | 0,0146 | 2,70 | 0,0000 | 0,0229 |
| S31- | Forchtenstein | KN Mattersburg | 0,93 | 0,0000 | 0,0036 | 0,93 | 0,0000 | 0,0057 | 1,30 | 0,0000 | 0,0084 | 1,30 | 0,0000 | 0,0132 | 1,95 | 0,0000 | 0,0106 | 1,95 | 0,0000 | 0,0166 |
| S31- | Sieggraben | Forchtenstein | 1,29 | 0,0000 | 0,0051 | 1,30 | 0,0000 | 0,0080 | 1,82 | 0,0000 | 0,0117 | 1,82 | 0,0000 | 0,0184 | 2,72 | 0,0000 | 0,0148 | 2,73 | 0,0000 | 0,0232 |
| S31- | Weppersdorf/Kobersdorf | Sieggraben | 1,56 | 0,0000 | 0,0061 | 1,56 | 0,0000 | 0,0096 | 2,19 | 0,0000 | 0,0141 | 2,20 | 0,0000 | 0,0222 | 3,28 | 0,0000 | 0,0178 | 3,29 | 0,0000 | 0,0279 |
| S31- | Weppersdorf/Markt St.Martin | Weppersdorf/Kobersdorf | 0,32 | 0,0000 | 0,0013 | 0,32 | 0,0000 | 0,0020 | 0,45 | 0,0000 | 0,0029 | 0,45 | 0,0000 | 0,0046 | 0,67 | 0,0000 | 0,0037 | 0,68 | 0,0000 | 0,0057 |
| S31- | Neutal | Weppersdorf/Markt St.Martin | 0,74 | 0,0000 | 0,0029 | 0,74 | 0,0000 | 0,0046 | 1,04 | 0,0000 | 0,0067 | 1,04 | 0,0000 | 0,0105 | 1,56 | 0,0000 | 0,0084 | 1,56 | 0,0000 | 0,0133 |
| S31- | Stoob Süd | Neutal | 0,65 | 0,0000 | 0,0025 | 0,65 | 0,0000 | 0,0040 | 0,91 | 0,0000 | 0,0058 | 0,91 | 0,0000 | 0,0092 | 1,36 | 0,0000 | 0,0074 | 1,36 | 0,0000 | 0,0116 |
| S31- | Oberpullendorf | Stoob Süd | 0,71 | 0,0000 | 0,0028 | 0,71 | 0,0000 | 0,0044 | 0,99 | 0,0000 | 0,0064 | 0,99 | 0,0000 | 0,0100 | 1,48 | 0,0000 | 0,0080 | 1,49 | 0,0000 | 0,0126 |
| S33- | St. Pölten Ost | KN St. Pölten | 0,38 | 0,0000 | 0,0015 | 0,38 | 0,0000 | 0,0024 | 0,54 | 0,0000 | 0,0035 | 0,54 | 0,0000 | 0,0054 | 0,81 | 0,0000 | 0,0044 | 0,81 | 0,0000 | 0,0069 |
| S33- | St. Pölten Nord | St. Pölten Ost | 0,68 | 0,0000 | 0,0027 | 0,68 | 0,0000 | 0,0042 | 0,95 | 0,0000 | 0,0061 | 0,95 | 0,0000 | 0,0096 | 1,42 | 0,0000 | 0,0077 | 1,43 | 0,0000 | 0,0121 |
| S33- | Herzogenburg Süd | St. Pölten Nord | 0,72 | 0,0000 | 0,0028 | 0,72 | 0,0000 | 0,0044 | 1,01 | 0,0000 | 0,0065 | 1,01 | 0,0000 | 0,0102 | 1,51 | 0,0000 | 0,0082 | 1,51 | 0,0000 | 0,0128 |
| S33- | Herzogenburg Stadt | Herzogenburg Süd | 0,38 | 0,0000 | 0,0015 | 0,38 | 0,0000 | 0,0024 | 0,54 | 0,0000 | 0,0035 | 0,54 | 0,0000 | 0,0054 | 0,80 | 0,0000 | 0,0044 | 0,81 | 0,0000 | 0,0069 |
| S33- | Herzogenburg Nord | Herzogenburg Stadt | 0,21 | 0,0000 | 0,0008 | 0,21 | 0,0000 | 0,0013 | 0,30 | 0,0000 | 0,0019 | 0,30 | 0,0000 | 0,0030 | 0,45 | 0,0000 | 0,0024 | 0,45 | 0,0000 | 0,0038 |
| S33- | Traismauer Süd | Herzogenburg Nord | 1,03 | 0,0000 | 0,0041 | 1,03 | 0,0000 | 0,0064 | 1,45 | | | | | | | | | | | |

| | | | | | | | | | | | | | | | | | | | | |
|------|--------------------------|--------------------------|------|--------|--------|------|--------|--------|------|--------|--------|------|--------|--------|------|--------|--------|------|--------|--------|
| S36- | Zeltweg Ost Spielberg | Knittelfeld West | 0,16 | 0,0000 | 0,0006 | 0,17 | 0,0000 | 0,0010 | 0,23 | 0,0000 | 0,0015 | 0,23 | 0,0000 | 0,0023 | 0,35 | 0,0000 | 0,0019 | 0,35 | 0,0000 | 0,0030 |
| S36- | Zeltweg West | Zeltweg Ost Spielberg | 1,07 | 0,0000 | 0,0042 | 1,07 | 0,0000 | 0,0066 | 1,50 | 0,0000 | 0,0097 | 1,51 | 0,0000 | 0,0152 | 2,25 | 0,0000 | 0,0122 | 2,26 | 0,0000 | 0,0192 |
| S36- | Judenburg Ost Fohnsdorf | Zeltweg West | 0,54 | 0,0000 | 0,0021 | 0,54 | 0,0000 | 0,0033 | 0,76 | 0,0000 | 0,0049 | 0,76 | 0,0000 | 0,0077 | 1,13 | 0,0000 | 0,0061 | 1,14 | 0,0000 | 0,0097 |
| S36- | Judenburg West | Judenburg Ost Fohnsdorf | 0,84 | 0,0000 | 0,0033 | 0,84 | 0,0000 | 0,0052 | 1,17 | 0,0000 | 0,0076 | 1,18 | 0,0000 | 0,0119 | 1,76 | 0,0000 | 0,0095 | 1,76 | 0,0000 | 0,0150 |
| S36- | St. Georgen Ost | As B317 (prov.) | 0,09 | 0,0000 | 0,0003 | 0,09 | 0,0000 | 0,0005 | 0,12 | 0,0000 | 0,0008 | 0,12 | 0,0000 | 0,0012 | 0,18 | 0,0000 | 0,0010 | 0,18 | 0,0000 | 0,0016 |
| S36- | St. Georgen West | St. Georgen Ost | 0,16 | 0,0000 | 0,0006 | 0,16 | 0,0000 | 0,0010 | 0,23 | 0,0000 | 0,0015 | 0,23 | 0,0000 | 0,0023 | 0,34 | 0,0000 | 0,0018 | 0,34 | 0,0000 | 0,0029 |
| | | | | | | | | | | | | | | | | | | | | |
| S37- | St. Veit Mitte / Brückl | St. Veit Nord | 0,51 | 0,0000 | 0,0020 | 0,51 | 0,0000 | 0,0031 | 0,71 | 0,0000 | 0,0046 | 0,71 | 0,0000 | 0,0072 | 1,07 | 0,0000 | 0,0058 | 1,07 | 0,0000 | 0,0091 |
| S37- | St. Veit Süd | St. Veit Mitte / Brückl | 0,43 | 0,0000 | 0,0017 | 0,43 | 0,0000 | 0,0027 | 0,60 | 0,0000 | 0,0039 | 0,61 | 0,0000 | 0,0061 | 0,91 | 0,0000 | 0,0049 | 0,91 | 0,0000 | 0,0077 |
| S37- | St. Veit Industriegebiet | St. Veit Süd | 0,32 | 0,0000 | 0,0013 | 0,32 | 0,0000 | 0,0020 | 0,45 | 0,0000 | 0,0029 | 0,46 | 0,0000 | 0,0046 | 0,68 | 0,0000 | 0,0037 | 0,68 | 0,0000 | 0,0058 |
| S37- | Maria Saal | St. Veit Industriegebiet | 1,14 | 0,0000 | 0,0045 | 1,14 | 0,0000 | 0,0070 | 1,60 | 0,0000 | 0,0103 | 1,60 | 0,0000 | 0,0162 | 2,39 | 0,0000 | 0,0130 | 2,40 | 0,0000 | 0,0204 |
| S37- | Karnburg | Maria Saal | 0,41 | 0,0000 | 0,0016 | 0,41 | 0,0000 | 0,0025 | 0,57 | 0,0000 | 0,0037 | 0,57 | 0,0000 | 0,0058 | 0,85 | 0,0000 | 0,0046 | 0,86 | 0,0000 | 0,0073 |
| S37- | Klagenfurt Nord | Karnburg | 0,35 | 0,0000 | 0,0014 | 0,36 | 0,0000 | 0,0022 | 0,50 | 0,0000 | 0,0032 | 0,50 | 0,0000 | 0,0050 | 0,75 | 0,0000 | 0,0040 | 0,75 | 0,0000 | 0,0064 |

APPENDIX 5

SIGNS INDICATING GO DISTRIBUTION OUTLETS:

In Austria – subordinate road network, existing toll points, border crossings:

1. Direction signs:

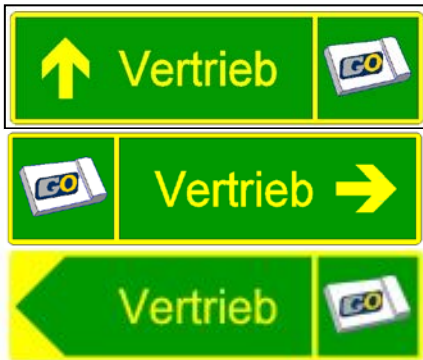

(‘old’ arrow shape only found in Tyrol)

2. Advance direction sign:



3. Sheet metal covers or stickers for existing direction signs:



e.g.:



In Germany:



In Slovenia:



Service area sign (in Slovenia: on existing signs):



In Hungary:



In Italy (Service area sign: on existing signs):



APPENDIX 6 – APPLICATION FOR REIMBURSEMENT NIGHT-TIME RATE A 13

| | |
|---|--|
| APPLICATION NUMBER: (to be filled out by ASFINAG!) | |
| <p>APPLICATION <u>Page 1</u></p> <p>according to section 4 Tolling Regulations Part B for the reimbursement of the accounted night-time rate on the A 13</p> <p>I / we apply for the reimbursement of the difference amount between the night-time rate and the regular rate for the following category 4 vehicle. I / we confirm, that the vehicle is authorized for the transportation of persons, and was not used for the transportation of goods during the time of the trip.</p> <p>1. TIME OF THE TRIP (in case of multiple trips on the A 13, pls. use page 2 of this form)</p> <p>Date of the (single) trip: Time of the trip: from till</p> <p>Distance covered (motorway junctions from - till):</p> <p>2. INFORMATION ABOUT THE VEHICLE</p> <p>Nationality / Vehicle registration number: /</p> <p>Vehicle type / number of axles: /</p> <p>GO-Box number (if known):</p> <p>3. INFORMATION ABOUT THE VEHICLE'S REGISTERED OWNER</p> <p>First and last name (company name): /</p> <p>Address:</p> <p>Contact person:</p> <p>Phone / Fax / E-mail: / /</p> <p>4. BANK DETAILS OF THE REGISTERED OWNER OF THE VEHICLE</p> <p>Bank:</p> <p>Bank code number (BIC / SWIFT Code):</p> <p>Bank account number (IBAN):</p> <p>Please ask for these details (BIC/SWIFT and IBAN), if not already known, at your bank.</p> <p>5. ATTACHMENTS</p> <p>To ensure proper processing of your application, the following documents are to be attached to the application form:</p> <ul style="list-style-type: none"> • Proof that the night-time rate has been charged (e.g. detailed statement of toll transactions or list of the latest toll transactions). • Copy of the vehicle's registration document (only for the first application request) <p>The completed and duly signed form is to be sent by post or by fax to: ASFINAG Maut Service GmbH, Am Europlatz 1, A-1120 Wien Fax from Austria: 0800 400 11 444, Fax from other countries: 0043 1 955 12 77</p> | |
| <p>.....</p> <p>Location, date</p> | <p>.....</p> <p>(Signature of the registered owner of the vehicle)</p> |

Nationality / Vehicle registration number: /

APPLICATION

Page 2

according to section 4 Tolling Regulations Part B for the reimbursement
of the accounted night-time rate on the A 13

TIME OF FURTHER TRIPS

Date of the (single) trip: Time of the trip: from till

Distance covered (motorway junctions from - till):

Date of the (single) trip: Time of the trip: from till

Distance covered (motorway junctions from - till):

Date of the (single) trip: Time of the trip: from till

Distance covered (motorway junctions from - till):

Date of the (single) trip: Time of the trip: from till

Distance covered (motorway junctions from - till):

Date of the (single) trip: Time of the trip: from till

Distance covered (motorway junctions from - till):

Date of the (single) trip: Time of the trip: from till

Distance covered (motorway junctions from - till):

Date of the (single) trip: Time of the trip: from till

Distance covered (motorway junctions from - till):

Date of the (single) trip: Time of the trip: from till

Distance covered (motorway junctions from - till):

Date of the (single) trip: Time of the trip: from till

Distance covered (motorway junctions from - till):

Date of the (single) trip: Time of the trip: from till

Distance covered (motorway junctions from - till):

Date of the (single) trip: Time of the trip: from till

Distance covered (motorway junctions from - till):

.....
Location, date

.....
(Signature of the registered owner of the vehicle)

APPENDIX 7a – APPLICATION FOR REIMBURSEMENT for non-military vehicles up to 3.5 t GVW in the scope of PfP-SOFA

| | |
|---|---|
| APPLICATION NUMBER: (to be filled out by ASFINAG!) | |
| APPLICATION | |
| according to section 5 (1)(3) Federal Road Tolls Act and section 1.3.3.1, third subparagraph, Tolling Regulations Part A for the reimbursement of the accounted time-related toll | |
| I / we apply for the reimbursement of the accounted time-related toll for the following vehicle. I / we confirm, that the vehicle was used within the meaning of section 1.3.3.1, Tolling Regulations Part A I. | |
| 1. TIME OF THE TRIP | |
| Date of the single trip: | Time of the trip: from till |
| Distance covered (motorway junctions from - till): | |
| 2. INFORMATION ABOUT THE VEHICLE | |
| Nationality / Vehicle registration number: / | |
| Vehicle type: | |
| 3. INFORMATION ABOUT THE VEHICLE'S REGISTERED OWNER | |
| First and last name (company name): / | |
| Address: | |
| Contact person: | |
| Phone # / Fax # / E-mail: / / | |
| 4. BANK DETAILS OF THE REGISTERED OWNER OF THE VEHICLE | |
| Bank: | |
| Bank code number (BIC / SWIFT Code): | |
| Bank account number (IBAN): | |
| Please ask for these details (BIC/SWIFT and IBAN), if not already known, at your bank. | |
| 5. ATTACHMENTS | |
| To ensure proper processing of your application, the following documents are to be attached to the application form: | |
| <ul style="list-style-type: none"> • NATO-form (EUFOR, KFOR, US ARMY, ...), military way-bills or similar, which fit exactly to the vehicle registration number and show the correct date. | |
| The completed and duly signed form is to be sent by post or by fax to: ASFINAG Maut Service GmbH, Am Europlatz 1, A-1120 Wien | |
| Fax from Austria: 0800 400 11 444, Fax from other countries: 0043 1 955 12 77. | |
| Location, date | (Signature of the registered owner of the vehicle) |

**APPENDIX 7b – APPLICATION FOR REIMBURSEMENT
for non-military vehicles of more than 3.5 t GVW in the scope of PfP-SOFA**

| | |
|--|---|
| APPLICATION NUMBER: (to be filled out by ASFINAG!) | |
| APPLICATION | |
| Page 1 | |
| according to section 5 (1)(3) Federal Road Tolls Act and section 3.3.1 Tolling Regulations Part B for the reimbursement of the accounted distance-related toll | |
| I / we apply for the reimbursement of the accounted time-related toll for the following vehicle. I / we confirm, that the vehicle was used within the meaning of section 3.3.1, third subparagraph, Tolling Regulations Part B. | |
| 1. TIME OF THE TRIP | |
| Date of the single trip: | Time of the trip: from till |
| Distance covered (motorway junctions from - till): | |
| 2. INFORMATION ABOUT THE VEHICLE | |
| Nationality / Vehicle registration number: / | |
| Vehicle type / number of axles: / | |
| GO-Box number (if known): | |
| 3. INFORMATION ABOUT THE VEHICLE'S REGISTERED OWNER | |
| First and last name (company name): / | |
| Address: | |
| Contact person: | |
| Phone / Fax / E-mail: / / | |
| 4. BANK DETAILS OF THE REGISTERED OWNER OF THE VEHICLE | |
| Bank: | |
| Bank code number (BIC / SWIFT Code): | |
| Bank account number (IBAN): | |
| Please ask for these details (BIC/SWIFT and IBAN), if not already known, at your bank. | |
| 5. ATTACHMENTS | |
| To ensure proper processing of your application, the following documents are to be attached to the application form: | |
| <ul style="list-style-type: none"> • NATO-form (EUFOR, KFOR, US ARMY, ...), military way-bills or similar, which fit exactly to the vehicle registration number and show the correct date. • Pre-pay receipt for pre-pay GO-Boxes • if applicable receipts for retroactive payments | |
| The completed and duly signed form is to be sent by post or by fax to: ASFINAG Maut Service GmbH, Am Europlatz 1, A-1120 Wien Fax: 0043 1 955 12 77 | |
| Location, date | (Signature of the registered owner of the vehicle) |

Nationality / Vehicle registration number: /

APPLICATION

Page 2

according to section 5 (1)(3) Federal Road Tolls Act and section 3.3.1 Tolling Regulations Part B for the reimbursement of the accounted distance-related toll

TIME OF FURTHER TRIPS

Date of the (single) trip: Time of the trip: from till

Distance covered (motorway junctions from - till):

Date of the (single) trip: Time of the trip: from till

Distance covered (motorway junctions from - till):

Date of the (single) trip: Time of the trip: from till

Distance covered (motorway junctions from - till):

Date of the (single) trip: Time of the trip: from till

Distance covered (motorway junctions from - till):

Date of the (single) trip: Time of the trip: from till

Distance covered (motorway junctions from - till):

Date of the (single) trip: Time of the trip: from till

Distance covered (motorway junctions from - till):

Date of the (single) trip: Time of the trip: from till

Distance covered (motorway junctions from - till):

Date of the (single) trip: Time of the trip: from till

Distance covered (motorway junctions from - till):

Date of the (single) trip: Time of the trip: from till

Distance covered (motorway junctions from - till):

Date of the (single) trip: Time of the trip: from till

Distance covered (motorway junctions from - till):

Date of the (single) trip: Time of the trip: from till

Distance covered (motorway junctions from - till):

.....
Location, date

.....
(Signature of the registered owner of the vehicle)